

---

## **SPLIT SYSTEM Air Conditioners**

---

### MODELS

#### **Ceiling-mounted Duct type**

**FBQ18PVJU**

**FBQ24PVJU**

**FBQ30PVJU**

**FBQ36PVJU**

**FBQ42PVJU**

**FBQ48PVJU**

English

Français

Español

---

Read these instructions carefully before installation.  
Keep this manual in a handy place for future reference.  
This manual should be left with the equipment owner.

Lire soigneusement ces instructions avant l'installation.  
Conserver ce manuel à portée de main pour référence ultérieure.  
Ce manuel doit être donné au propriétaire de l'équipement.

Lea cuidadosamente estas instrucciones antes de instalar.  
Guarde este manual en un lugar a mano para leer en caso de tener alguna duda.  
Este manual debe permanecer con el propietario del equipo.

---

# CONTENTS

1. SAFETY CONSIDERATIONS .....	1
2. WHAT TO DO BEFORE OPERATION .....	3
3. OPERATION RANGE .....	3
4. INSTALLATION SITE .....	4
5. OPERATION PROCEDURE.....	4
6. OPTIMUM OPERATION.....	4
7. MAINTENANCE.....	5
8. PROPER OPERATION OF THE AIR CONDITIONER.....	6
9. TROUBLE SHOOTING.....	7

## 1. SAFETY CONSIDERATIONS

Read these *Safety Considerations for Operations* carefully before installing air conditioning equipment. After completing the installation, make sure that the unit operates properly during the startup operation. Instruct the customer on how to operate and maintain the unit.

Inform customers that they should store this Operation Manual with the Installation Manual for future reference.

Meanings of **DANGER**, **WARNING**, **CAUTION**, and **NOTE**

Symbols:

 **DANGER** ..... Indicates an imminently hazardous situation which, if not avoided, will result in death or serious injury.

 **WARNING**..... Indicates a potentially hazardous situation which, if not avoided, could result in death or serious injury.

 **CAUTION**..... Indicates a potentially hazardous situation which, if not avoided, may result in minor or moderate injury. It may also be used to alert against unsafe practices.

 **NOTE**..... Indicates situations that may result in equipment or property damage accidents only.

### **DANGER**

- Do not install the unit in an area where flammable materials are present due to risk of explosion resulting in serious injury or death.
- Any abnormalities in the operation of the air conditioner such as smoke or fire could result in severe injury or death. Turn off the power and contact your dealer immediately.
- Refrigerant gas may produce toxic gas if it comes in contact with fire, such as from a fan, heater, stove, or cooking device. Exposure to this gas could cause severe injury or death.

- For refrigerant leakage, consult your dealer. Refrigerant gas is heavier than air and replaces oxygen. A massive leak could lead to oxygen depletion, especially in basements, and an asphyxiation hazard could occur leading to serious injury or death.
- If equipment utilizing a burner is used in the same room as the air conditioner, there is the danger of oxygen deficiency which could lead to an asphyxiation hazard resulting in serious injury or death. Be sure to ventilate the room sufficiently to avoid this hazard.
- Safely dispose of the packing materials. Packing materials, such as nails and other metal or wooden parts, may cause stabs or other injuries.
- Tear apart and throw away plastic packaging bags so that children will not play with them. Children playing with plastic bags face the danger of death by suffocation.

### **WARNING**

- Contact your dealer for repair and maintenance. Improper repair and maintenance may result in water leakage, electric shock, and fire. Only use accessories made by Daikin that are specifically designed for use with the equipment and have them installed by a professional.
- Contact your dealer to move and reinstall the air conditioner. Incomplete installation may result in water leakage, electric shock, and fire.
- Never let the indoor unit or the remote controller get wet. Water can cause an electric shock or a fire.
- Never use flammable spray such as hair spray, lacquer, or paint near the unit. Flammable spray may cause a fire.
- When a fuse blows out, never replace it with one of incorrect ampere ratings or different wires. Always replace any blown fuse with a fuse of the same specification.
- Never remove the fan guard of the unit. A fan rotating at high speed without the fan guard is very dangerous.
- Never inspect or service the unit by yourself. Contact a qualified service person to perform this work.
- Turn off all electrical power before doing any maintenance to avoid the risk of serious electric shock; never sprinkle or spill water or liquids on the unit.
- Do not touch the switch with wet fingers. Touching a switch with wet fingers can cause electric shock.
- Do not allow children to play on or around the unit to prevent injury.
- The heat exchanger fins are sharp enough to cut. To avoid injury wear gloves or cover the fins while working around them.
- Do not put a finger or other objects into the air inlet or air outlet. The fan is rotating at high speed and may cause injury.
- Check the unit foundation for damage on a regular basis, especially if it has been in use for a long time. If left in a damaged condition the unit may fall and cause injury.
- Placing a flower vase or other containers with water or other liquids on the unit could cause a shock or fire if a spill occurs.
- Do not touch the air outlet or horizontal blades while the swing flap is in operation because fingers could get caught and injured.

- Never touch the internal parts of the controller. Do not remove the control box cover because some parts inside are dangerous to touch. To check and adjust internal parts, contact your dealer.
- Be sure to ground the unit.  
Do not ground the unit to a utility pipe, arrester, or telephone ground. Incomplete grounding may cause electric shock, or fire. A high surge current from lightning or other sources may cause damage to the air conditioner.
- This equipment can be installed with a Ground-Fault Circuit Interrupter (GFCI). Although this is a recognized measure for additional protection, with the grounding system in North America, a dedicated GFCI is not necessary.



#### CAUTION

- Do not use the air conditioner for any other purposes other than comfort cooling or heating. Do not use the unit for cooling precision instruments, food, plants, animals or works of art.
- Do not place items under the indoor unit as they may be damaged by condensates that may form if the humidity is above 80%, or if the drain outlet gets blocked.
- Before cleaning, turn the unit off and disengage power. Otherwise, an electric shock and injury may result.
- Do not wash the air conditioner with excessive water. An electric shock or fire may result.
- Avoid placing the controller in a spot where it can be splashed with water. Water entering the controller may cause an electric shock or damage the internal electronic parts.
- Do not operate the air conditioner when using a room fumigation type of insecticide. Failure to observe this could cause the chemicals to be deposited in the unit and can endanger the health of those who are hypersensitive to chemicals.
- Do not turn off the power immediately after stopping operation. Always wait for at least five minutes before turning off the power. Otherwise, water leakage may occur.
- The appliance is not intended for use by young children or infirm persons without supervision.
- The remote controller should be kept away from children so they cannot play with it.
- Consult with the installation contractor for cleaning.
- Incorrect cleaning of the inside of the air conditioner could make the plastics parts break and cause water leakage or electric shock.
- Do not touch the air inlet or aluminum fin of the air conditioner as they can cut and cause injury.



#### NOTE

- Never press the button of the remote controller with a hard, pointed object. The remote controller may be damaged.
- Never pull or twist the electric wire of the remote controller. It may cause the unit to malfunction.
- Do not place appliances that produce open flames in places that are exposed to the airflow of the unit or under the indoor unit. It may cause incomplete combustion or deformation of the unit due to the heat.

- Do not expose the controller to direct sunlight. The LCD display can become discolored and may fail to display the data.
  - Do not wipe the controller operation panel with benzene, thinner, chemical dust cloth, etc. The panel may get discolored or the coating can peel off. If it is heavily dirty, soak a cloth in water-diluted neutral detergent, squeeze it well and wipe the panel clean. Then wipe it with another dry cloth.
  - Dismantling of the unit, disposal of the refrigerant, oil, and additional parts, should be done in accordance with the relevant local, state, and national regulations.
  - Operate the air conditioner in a sufficiently ventilated area and not surrounded by obstacles. Do not use the air conditioner in the following places.
    - a. Places with a mist of mineral oil, such as cutting oil.
    - b. Locations such as coastal areas where there is a lot of salt in the air.
    - c. Locations such as hot springs where there is a lot of sulfur in the air.
    - d. Locations such as factories where the power voltage varies a lot.
    - e. In cars, boats, and other vehicles.
    - f. Locations such as kitchens where oil may splatter or where there is steam in the air.
    - g. Locations where equipment produces electromagnetic waves.
    - h. Places with an acid or alkaline mist.
    - i. Places where fallen leaves can accumulate or where weeds can grow.
  - Do not attempt to do electrical work or grounding work unless you are licensed to do so. Consult with your dealer for electrical work and grounding work.
  - Make sure that there are no obstacles close to the outdoor unit. Obstacles close to the outdoor unit may drop the performance of the outdoor unit or increase the operating sound of the outdoor unit.
  - Consult your dealer if the air conditioner in operation generates unusual noise.
  - Make sure that the drainpipe is installed properly to drain water. If no water is discharged from the drainpipe while the air conditioner is in the cooling mode, the drainpipe may be clogged with dust or dirt and water leakage from the indoor unit may occur. Stop operating the air conditioner and contact your dealer.
-

## 2. WHAT TO DO BEFORE OPERATION

This operation manual is for the system with standard control. Before initiating operation, contact your Daikin dealer for the operation that corresponds to your system.

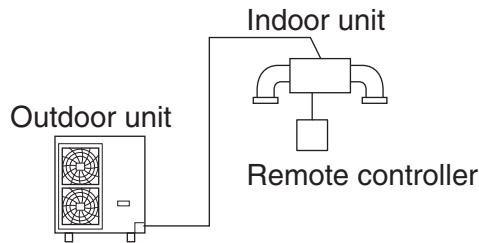

If your installation has a customized control system, ask your Daikin dealer for the operation that corresponds to your system.

- Heat pump type  
This system provides cooling, heating, automatic, drying and fan operation modes.
- Cooling only type  
This system provides cooling, drying and fan operation modes.

### PRECAUTIONS FOR TWO REMOTE CONTROLLERS CONTROL SYSTEM

This system provides another control system beside individual control (one remote controller controls one indoor unit) system. Confirm the following if your unit is the following control system type.

- **Two remote controllers control system**  
Two remote controllers control one indoor unit. The unit is individually operated.

#### NOTE

- Contact your Daikin dealer in case of changing setting of two remote controllers control system.

## Names and functions of parts

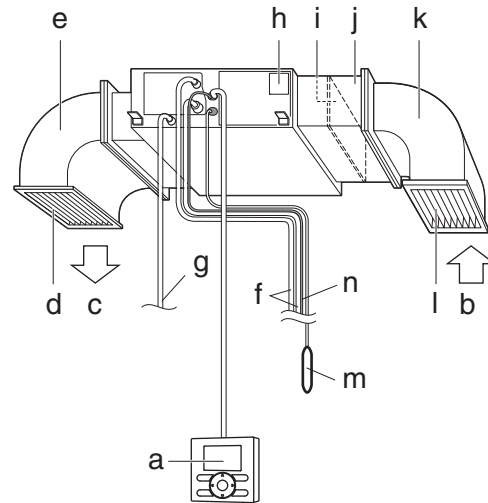

<b>a</b>	Remote controller (Optional accessory) Depending on the system configuration, the remote controller is not provided.
<b>b</b>	Air inlet
<b>c</b>	Discharge air
<b>d</b>	Discharge grille (Field supply)
<b>e</b>	Exhaust duct (Field supply)
<b>f</b>	Refrigerant piping
<b>g</b>	Drain piping
<b>h</b>	Model name (model name plate)
<b>i</b>	Air filter (Optional accessory)
<b>j</b>	Suction filter chamber (Optional accessory)
<b>k</b>	Suction duct (Field supply)
<b>l</b>	Suction grille (Field supply)
<b>m</b>	Ground wiring Wire to ground from the indoor unit to prevent electric shock.
<b>n</b>	Transmission wiring

## 3. OPERATION RANGE

If the temperature or the humidity is beyond the following conditions, safety devices may work and the air conditioner may not operate, or sometimes, water may drop from the indoor unit.

OPERATION	TEMPERATURE	
	OUTDOOR	INDOOR
COOLING	23 to 122°F DB (-5 to 50°C DB)	57 to 77°F WB (14 to 25°C WB)
HEATING	-4 to 60°F WB (-20 to 15.6°C WB)	59 to 80.5°F DB (15 to 27°C DB)

DB: Dry bulb temperature (°F (°C))  
WB: Wet bulb temperature (°F (°C))

The setting temperature range of the remote controller is 60°F (16°C) to 90°F (32°C).

## 4. INSTALLATION SITE

### Regarding places for installation

- **Is the air conditioner installed at a well-ventilated place where there are no obstacles around?**
- **Do not use the air conditioner in the following places.**
  - a. Filled with much mineral oil such as cutting oil
  - b. Where there is much salt such as a beach area
  - c. Where sulfuric gas exists such as a hot-spring resort
  - d. Where there are considerable voltage fluctuations such as a factory or plant
  - e. Vehicles and vessels
  - f. Where there is oil splatter and vapor such as a kitchen, etc.
  - g. Where there are machines generating electromagnetic waves
  - h. Areas filled with acid and/or alkaline steam or vapor
- **Is a snow protection measure taken?**  
For details, consult your dealer.

### Regarding wiring

- **All wiring must be performed by an authorized electrician.**  
To do wiring, ask your dealer. Never do it by yourself.
- **Make sure that a separate power supply circuit is provided for this air conditioner and that all electrical work is carried out by qualified personnel according to local laws and regulations.**

### Pay attention to noise during operation, too

- **Are the following places selected?**
  - a. A place that can sufficiently withstand the weight of the air conditioner with less noise while running and vibrations.
  - b. A place where the airflow and noise generated from the air outlet by the outdoor unit is not a nuisance to the neighborhood.
- **Are you sure that there are no obstacles near the air outlet of the outdoor unit?**  
Such obstacles may result in declined performance and increased running noises.
- **If abnormal noise occurs while in use, consult your dealer.**

### Regarding drainage of drain piping

- **Is the drain pipe able to perform complete drainage?**  
If proper drainage is not carried out from the outdoor drain pipes during cooling operation, chances are that dust and dirt are clogged in the pipe. This may result in water leakage from the indoor unit. Under such circumstances, stop the operation of the air conditioner, and then consult your dealer or our service station.

## 5. OPERATION PROCEDURE

### Read the operation manual that came with the remote controller.

- Operating procedure varies with heat pump type and cooling only type. Contact your Daikin dealer to confirm your system type.
- To protect the unit, turn on the main power switch 6 hours before operation.
- If the main power supply is turned off during operation, operation will restart automatically after the power turns back on again.

## 6. OPTIMUM OPERATION

Observe the following precautions to ensure the system operates.

- Adjust the room temperature properly for a comfortable environment. Avoid excessive heating or cooling.
- Prevent direct sunlight from entering a room during cooling operation by using curtains or blinds.
- Ventilate the room regularly.  
Using the unit for long periods of time requires attentive ventilation of the room.
- Keep doors and windows closed. If the doors and windows remain open, room air will escape and diminish performance of cooling and heating operation.
- Do not place other heaters directly below the indoor unit.  
They may deform due to the heat.
- Do not block the air inlet or air outlet of the unit as it will cause a decrease in performance or stop operation.
- Turn off the main power supply switch when it is not used for long periods of time. When the main power switch is turned on, some watts of electricity is being used even if the system is not operating. Turn off the main power supply switch for saving energy. When reoperating, turn on the main power supply switch 6 hours before operation for smooth running (Refer to MAINTENANCE).
- When the display shows "Time to clean filter" ask a qualified service person to clean the filter (Refer to MAINTENANCE).
- It takes time for the room temperature to reach the set temperature.  
We recommend starting the operation in advance using timer operation.

## 7. MAINTENANCE



### WARNING

- Only a qualified person is allowed to perform maintenance outside of daily maintenance.
- Before touching any of connection wirings, be sure to turn off all power supply switches.
- Do not use flammable materials (for example, hairspray or insecticide) near the product.  
Do not clean the product with organic solvents such as paint thinner.

The use of organic solvents may cause crack damage to the product, electric shocks, or fire.

- Contact your dealer about attachment of accessories and be sure to use only accessories specified by the manufacturer.

If a defect results from your own workmanship, it may result in water leaks, electric shock or fire.



### CAUTION

- Before cleaning, be sure to stop unit operation, turn the breaker off or remove the power cord.  
Otherwise, an electric shock and injury may result.
- Do not wash the air conditioner with water, as this may result in electric shocks or fire.
- Consult your dealer regarding cleaning the inside of the air conditioner.

Improper cleaning may cause breakage of plastic parts, water leakage and other damage as well as electric shocks.

- Use appropriate equipment at the time of air filter cleaning or inspection.

Work at higher elevation requires a ladder or scaffolding. If these are unstable you may fall, thus causing injury.

### HOW TO CLEAN THE AIR FILTER

(The air filter is a field supply.)

Clean the air filter when the display shows "Time to clean filter".

- This message is displayed once the unit has operated for a certain amount of time.
- Always clean the air filter at the beginning of the heating or cooling season.  
(Dust and dirt in the air filter reduce airflow, lowering the unit's capacity.)
- Clean the air filter more frequently when using the unit in a dirty environment.

### NOTES

- Do not remove the air filter for reasons other than cleaning purposes.  
Doing so may cause damage to the unit.  
(The unit does not include an air filter as standard equipment.)
- Do not install any object other than a proper air filter in the suction inlet (for example, a paper towel). Doing so may result in degraded performance and cause freezing or water leakage.

1. Select "Reset Filter Indicator" on the main menu screen and press Menu/Enter button, after the air filter is cleaned and attached.

The "Time to clean filter" message will be turned OFF.

Refer to the operation manual provided with the Remote controller.

### HOW TO CLEAN AIR OUTLET AND OUTSIDE PANELS (Field supply)

1. Clean with soft cloth.
2. When it is difficult to remove stains, use water or neutral detergent.

### NOTES

- Do not use gasoline, benzene, thinner, polishing powder, or liquid insecticide. It may cause discoloring or warping.
- Do not let the indoor unit get wet. It may cause an electric shock or a fire.
- Do not use hot water of 122°F (50°C) or higher, as doing so may result in discoloration or deformation.

### START UP AFTER A LONG STOP

#### Confirm the following.

- Check that the air inlet and outlet are not blocked.  
Remove any obstacle.
- Check if the ground is connected.  
Might there be a broken wire somewhere?  
Contact your dealer if there are any problems.

#### Clean the air filter and outside panels.

- After cleaning the air filter, make sure to re-attach it.

#### Turn on the main power supply switch.

- The display on the remote controller will be shown when the power is turned on.
- To protect the unit, turn on the main power switch at least 6 hours before operation.

### WHAT TO DO WHEN STOPPING THE SYSTEM FOR A LONG PERIOD

#### Turn on FAN OPERATION for a half day and dry the unit.

- Read the operation manual attached to the remote controller.

#### Turn off the power supply.

- When the main power switch is turned on, some watts of electricity is being used even if the system is not operating.  
Turn off the main power supply switch for saving energy.
- The display on the remote controller will vanish when the main power switch is turned off.

#### Clean the air filter and the exterior.

- Be sure to replace the air filter to its original place after cleaning. Refer to "MAINTENANCE".

## 8. PROPER OPERATION OF THE AIR CONDITIONER

The following symptoms do not indicate air conditioner malfunction

### I. THE SYSTEM DOES NOT OPERATE

- **The system does not restart immediately after the ON/OFF button is pressed.**

If the OPERATION lamp lights, the system is in normal condition.

It does not restart immediately because a safety device operates to prevent overload of the system. After 3 minutes, the system will turn on again automatically.

- **The system does not restart immediately when TEMPERATURE SETTING button is returned to the former position after pushing the button.**

If the OPERATION lamp lights, the system is in normal condition.

It does not restart immediately because a safety device operates to prevent overload of the system. After 3 minutes, the system will turn on again automatically.

- **The system does not start when the display shows “CENTRAL CONTROL” and it flashes for a few seconds after pressing an operation button.**

This is because the system is under centralized control. Flashes on the display indicates that the system cannot be controlled by the remote controller.

- **The system does not start immediately after the power supply is turned on.**

Wait one minute until the micro computer is ready for operation.

### II. WHITE MIST COMES OUT OF THE UNIT

- **When humidity is high during cooling operation. (In oily or dusty places)**

If the inside of an indoor unit is extremely contaminated, the temperature distribution inside a room becomes uneven. It is necessary to clean the inside of the indoor unit. Ask your Daikin dealer for details on cleaning the unit. This operation requires a qualified service person.

- **When the system is changed over to HEATING OPERATION after DEFROST OPERATION.**

Moisture generated by DEFROST becomes steam.

### III. NOISE OF AIR CONDITIONERS

- **A ringing sound after the unit is started.**

This is the starting sound of the motor which moves the air-flow direction blades.

It will quiet down after about one minute.

- **A continuous “Whoosh” is heard when the system is in COOLING or DEFROST OPERATION.**

This is the sound of refrigerant gas flowing through both indoor and outdoor units.

- **A “Whoosh” sound is heard at the start or immediately after the stop of operation and at the start or immediately after the stop of DEFROST OPERATION.**

This is the noise of refrigerant caused by flow stop and flow change.

- **A continuous flow “Whoosh” sound is heard when the system is in COOLING OPERATION or at a stop.**

The noise is heard when the drain pump is in operation.

### IV. DUST FROM THE UNIT

- **Dust may blow out from the unit after starting operation after not being used for a while.**

Dust absorbed by the unit blows out.

### V. THE UNIT GIVES OFF ODORS

The unit absorbs odors in the room, furniture, cigarettes, etc., and then emits them.

### VI. THE LIQUID CRYSTAL OF THE REMOTE CONTROLLER DISPLAY “Checking the connection. Please stand by”

- **This occurs immediately after the main power supply switch is turned on.**

This indicates that the remote controller is in normal condition and continues temporarily.

## 9. TROUBLE SHOOTING

### I. If one of the following malfunctions occurs, take the measures shown below and contact your Daikin dealer.

The system must be repaired by a qualified service person.



#### WARNING

**If the air conditioner is operating abnormally, such as a burning smell, unplug the power cord from the outlet, and contact your dealer**

Continued operation under such circumstances may result in a failure, electric shock or fire.

- If a safety device such as a fuse, a breaker or a ground fault circuit interrupter frequently actuates;  
**Procedure:** Do not turn on the main power switch, take the following actions.
- If the ON/OFF switch does not properly work;  
**Procedure:** Turn off the main power switch.
- If water leaks from unit.  
**Procedure:** Stop the operation.

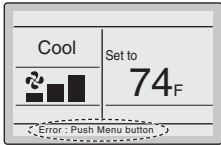

- If an error occurs, either one of the following items will flash in the basic screen.  
"Error: Push Menu button"  
\* The operation lamp will flash.  
"Warning: Push Menu button"  
\* The operation lamp will not flash.  
Press Menu / OK button.

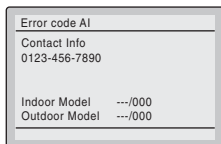
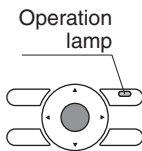

- The error code will flash and the service contact and model name or code may appear.
- Notify your Daikin dealer of the Error code and model name or code.

### II. If the system does not properly operate (except for the above mentioned case), and none of the other mentioned malfunctions are evident, investigate the system according to the following procedures.

#### 1. If the system does not operate at all.

- Check if there is a power failure.  
Wait until power is restored. If power failure occurs during operation, the system automatically restarts immediately after the power supply recovers.
- Check if no fuse has blown.  
Turn off the power supply.

- Check if the breaker is blown.  
Turn the power on with the breaker switch in the off position.  
Do not turn the power on with the breaker switch in the trip position.  
(Contact your dealer.)

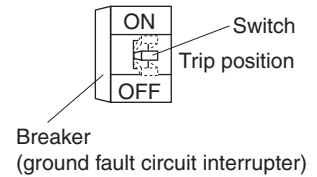

#### 2. If the system stops operating after it has been running normally.

- Check if the air inlet or outlet of outdoor or indoor unit is blocked by obstacles.  
Remove the obstacle and make it well-ventilated.
- Check if the air filter is clogged.  
Ask a qualified service person to clean the air filters (Refer to MAINTENANCE).

#### 3. The system operates but it does not sufficiently cool or heat, check if :

- If the air inlet or outlet of the indoor or the outdoor unit is blocked with obstacles.  
Remove the obstacle and make it well-ventilated.
- If the air filter is clogged.  
Ask a qualified service person to clean the air filters (Refer to MAINTENANCE).
- If the set temperature is not adequate.
- If the FAN SPEED button is set to LOW SPEED.
- If the doors or the windows are open. Shut doors or windows to prevent outside air from coming in.
- If direct sunlight enters the room (when cooling).  
Use curtains or blinds.
- When there are too many inhabitants in the room (when cooling).  
Cooling effect decreases if heat gain of the room is too large.
- If the heat source of the room is excessive (when cooling).  
Cooling effect decreases if heat gain of the room is too large.



**DAIKIN INDUSTRIES, LTD.**

Head office:  
Umeda Center Bldg., 2-4-12, Nakazaki-Nishi,  
Kita-ku, Osaka, 530-8323 Japan

Tokyo office:  
JR Shinagawa East Bldg., 2-18-1, Konan,  
Minato-ku, Tokyo, 108-0075 Japan

**DAIKIN NORTH AMERICA LLC**

5151 San Felipe, Suite 500  
Houston, TX 77056

