



EDUS092213A

**R-410A**

# Engineering Data

**Split Type Air Conditioners**  
**- Heat Pump -**

**RXL-W Series**

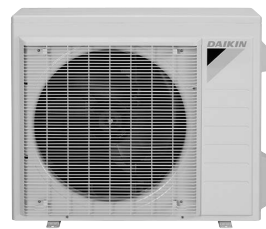
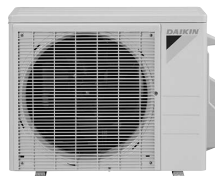
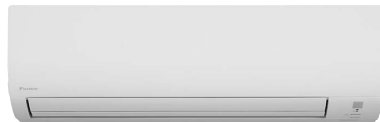

**INVERTER**





# Split Type Air Conditioners

## RXL-W Series

1. Lineup .....	4
2. Functions .....	5
3. Specifications.....	6
4. Dimensions .....	13
4.1 Indoor Unit .....	13
4.2 Outdoor Unit .....	18
5. Wiring Diagrams .....	20
5.1 Indoor Unit .....	20
5.2 Outdoor Unit .....	23
6. Piping Diagrams .....	25
6.1 Indoor Unit .....	25
6.2 Outdoor Unit .....	27
7. Capacity Tables .....	30
7.1 Capacity Correction Factor by the Length of Refrigerant Piping (Reference) .....	52
8. Operation Limit .....	54
9. Fan Characteristics.....	55
9.1 External Static Pressure .....	55
9.2 Airflow Auto Adjustment.....	58
10. Sound Level.....	60
10.1 Measuring Location .....	60
10.2 Indoor Unit .....	61
10.3 Outdoor Unit .....	66
11. Electric Characteristics .....	69
12. Installation Manual.....	70
12.1 FTX09/12/15 .....	70
12.2 FTX18/24 .....	82
12.3 FVXS .....	94
12.4 FDMQ .....	112
12.5 RXL09/12.....	136
12.6 RXL15/18/24.....	149
12.7 <BRC1E73> Wired Remote Controller .....	163

12.8 <BRC082A43> Wireless Remote Controller.....	184
13. Operation Manual .....	189
13.1 FTX09/12/15 .....	189
13.2 FTX18/24 .....	219
13.3 FVXS .....	256
13.4 FDMQ .....	292
13.5 General Safety Considerations (FTX, FDMQ, RXL).....	302
13.6 General Safety Considerations (FVXS).....	307
13.7 <BRC1E73> Wired Remote Controller .....	312
13.8 <BRC082A43> Wireless Remote Controller for FDMQ.....	362
14. Options .....	370
14.1 Option List.....	370
14.2 <BRC944B2> Wired Remote Controller Installation Manual .....	372
14.3 <BRC944B2> Wired Remote Controller Operation Manual .....	374
14.4 <BRCW901A03/08> Wired Remote Controller Cord.....	386
14.5 <KRP413BB1S> Wiring Adaptor for Timer Clock/Remote Controller.....	387
14.6 <KRP928BB2S> Interface Adaptor for DIII-NET .....	391
14.7 <KRP067A41> Interface Adaptor for Residential Air Conditioner .....	394
14.8 <KRP980B2> Interface Adaptor for Residential Air Conditioner .....	398
14.9 <DCS302C71> Central Remote Controller Installation Manual.....	402
14.10 <DCS302C71> Central Remote Controller Operation Manual .....	407
14.11 <DCS301C71> Unified ON/OFF Controller Installation Manual .....	433
14.12 <DCS301C71> Unified ON/OFF Controller Operation Manual .....	438
14.13 <DST301BA61> Schedule Timer Controller.....	440
14.14 <DST301BA61> Schedule Timer Controller Installation Manual.....	441
14.15 <DST301BA61> Schedule Timer Controller Operation Manual .....	446
14.16 <KRCS01-4B> Remote Sensor .....	459
14.17 <KRP1C74> Wiring Adaptor .....	462
14.18 <KRP4A98> Installation Box for Adaptor PCB .....	463
14.19 <KPW937F4> Air Direction Adjustment Grille .....	465
14.20 <KPW063B4> Air Direction Adjustment Grille .....	467
14.21 <KKG067A41> Back Protection Wire Net .....	469
14.22 <KKG063A42> Back Protection Wire Net .....	470
14.23 <KEH067A41EA, KEH063A4E, FTDBHMS, FTDBHML> Drain Pan Heater.....	471

14.24 <KPS067A41> Snow Hood (Intake Side Plate).....	477
14.25 <KPS067A42> Snow Hood (Intake Rear Plate) .....	479
14.26 <KPS067A44> Snow Hood (Outlet) .....	481
14.27 <KPS063A41> Snow Hood (Intake Side Plate).....	483
14.28 <KPS063A44> Snow Hood (Intake Rear Plate) .....	485
14.29 <KPS063A47> Snow Hood (Outlet) .....	487

# 1. Lineup

Indoor Unit		Outdoor Unit	Power Supply
Wall mounted type	FTX09WMVJU9	RXL09WMVJU9	1 phase, 208 - 230 V, 60 Hz
	FTX12WMVJU9	RXL12WMVJU9	
	FTX15WMVJU9	RXL15WMVJU9	
	FTX18WVJU9	RXL18WMVJU9	
	FTX24WVJU9	RXL24WMVJU9	
Floor standing type	FVXS09WVJU9	RXL09WMVJU9	
	FVXS12WVJU9	RXL12WMVJU9	
	FVXS15WVJU9	RXL15WMVJU9	
Duct concealed type	FDMQ12WVJU9	RXL12WMVJU9	
	FDMQ18WVJU9	RXL18WMVJU9	
	FDMQ24WVJU9	RXL24WMVJU9	

**Note:** Power Supply Intake ; Outdoor Unit

**Cautions**



1. Air conditioners should not be installed in areas where corrosive gasses, such as acid gas or alkaline gas, are produced.
2. If the outdoor unit is to be installed close to the sea shore, direct exposure to the sea breeze should be avoided and choose an outdoor unit with anti-corrosion treatment.

## 2. Functions

Category	Functions	Wall Mounted FTX				Floor Standing FVXS	Duct Concealed FDMQ	
		09	12	15	18/24		Wired R/C	Wireless R/C
Basic Function	Inverter (with inverter power control)	●	●	●	●	●	●	●
	Operation limit	Refer to page 54						
	PAM control	●	●	●	●	●	●	●
	Standby electricity saving	●	—	●	—	—	—	—
Compressor	Swing compressor	●	●	●	●	●	●	●
	Reluctance DC motor	●	●	●	●	●	●	●
Comfortable Airflow	Power-airflow flap (horizontal blade)	●	●	—	—	●	—	—
	Power-airflow dual flaps (horizontal blades)	—	—	●	●	—	—	—
	Wide-angle louvers (vertical blades)	●	●	●	●	●	—	—
	Auto-swing (up and down)	●	●	●	●	●	—	—
	Auto-swing (right and left)	—	—	—	●	—	—	—
	3-D airflow	—	—	—	●	—	—	—
	COMFORT AIRFLOW operation	●	●	●	●	—	—	—
Comfort Control	Auto fan speed	●	●	●	●	●	●	—
	Switchable fan speed	5 steps	5 steps	5 steps	5 steps	5 steps	3 steps	3 steps
	Indoor unit quiet operation	●	●	●	●	●	—	—
	OUTDOOR UNIT QUIET operation (manual)	—	—	—	●	●	—	—
	INTELLIGENT EYE operation (auto energy saving)	—	—	—	●	—	—	—
	2 selectable temperature sensors	—	—	—	—	—	●	—
	Quick warming function	●	●	●	●	—	●	●
	Hot-start function	●	●	●	●	●	●	●
	Automatic defrosting	●	●	●	●	●	●	●
Operation	Automatic cooling/heating changeover	●	●	●	●	●	●	●
	Program dry operation	●	●	●	●	●	●	●
	Fan only	●	●	●	●	●	●	●
Lifestyle Convenience	Inverter POWERFUL operation	●	●	●	●	●	—	—
	ECONO operation	●	●	●	●	●	—	—
	Indoor unit ON/OFF switch	●	●	●	●	●	—	—
	Emergency operation switch	—	—	—	—	—	—	●
	Signal receiving sign	●	●	●	●	●	—	●★1
Health and Cleanliness	Titanium apatite deodorizing filter	●	●	●	●	●	—	—
	Air filter (prefilter)	●	●	●	●	●	—	—
	Wipe-clean flat panel	●	●	●	●	●	—	—
	Silver ion anti-bacterial drain pan	—	—	—	—	—	●	●
	Filter cleaning indicator	—	—	—	—	—	●	●
Remote Control & Timer	WEEKLY TIMER operation	—	—	—	●	●	—	—
	Schedule timer	—	—	—	—	—	●	—
	24-hour ON/OFF TIMER	—	—	—	●	●	●	—
	72-hour ON/OFF TIMER	—	—	—	—	—	—	●
	Count up-down ON/OFF timer	●	●	●	—	—	—	●
	Off timer (turns unit off after set time)	—	—	—	—	—	●	—
	Setpoint auto reset	—	—	—	—	—	●	—
	Setpoint range set	—	—	—	—	—	●	—
	NIGHT SET mode	●	●	●	●	●	—	—
	Remote controller with back light	●	●	●	●	●	●	—
	DIII-NET compatible (adaptor)	Option	Option	Option	Option	Option	Option	Option
Wireless LAN connection	Option	Option	Option	Option	Option	Option	Option	
Worry Free (Reliability & Durability)	Auto-restart (after power failure)	●	●	●	●	●	●	●
	Self-diagnosis (R/C, LED)	●	●	●	●	●	●	●
	Anti-corrosion treatment of outdoor heat exchanger	●	●	●	●	●	●	●
Work & Servicing	Multi-split/split type compatible indoor unit	—	—	—	—	●	●	●
	Chargeless	32.8 ft. (10 m)	32.8 ft. (10 m)	32.8 ft. (10 m)	32.8 ft. (10 m)	32.8 ft. (10 m)	32.8 ft. (10 m)	32.8 ft. (10 m)
	Drain pump	—	—	—	—	—	●	●
	Either side drain (right or left)	●	●	●	●	—	—	—
	Low temperature cooling operation	-4°F ★2 (-20°C)	-4°F ★2 (-20°C)	-4°F ★2 (-20°C)	-4°F ★2 (-20°C)	-4°F ★2 (-20°C)	-4°F ★2 (-20°C)	-4°F ★2 (-20°C)
	°F/°C changeover R/C temperature display (factory setting: °F)	●	●	●	●	●	●	— (°F only)

● : Available  
 — : Not available

★1 : Receiving sound only  
 ★2 : Below 50°F (10°C):

Needs setting on outdoor unit.  
 09/12/15 class cutting jumper on the main PCB  
 18/24 class switch on the service monitor PCB  
 Need to install the air direction adjustment grille.

Below 14°F (-10°C):

### 3. Specifications

Model	Indoor Unit		FTX09WMVJU9		FTX12WMVJU9	
	Outdoor Unit		RXL09WMVJU9		RXL12WMVJU9	
			Cooling	Heating	Cooling	Heating
Power Supply			1 $\phi$ , 208 - 230 V, 60 Hz		1 $\phi$ , 208 - 230 V, 60 Hz	
Capacity Rated (Min. - Max.)	Btu/h		9,000 (4,400 - 10,900)	10,900 (4,400 - 16,000)	10,600 (4,400 - 13,300)	13,400 (4,400 - 18,800)
Running Current (Rated)	A		4.09 - 3.70	4.19 - 3.79	4.62 - 4.18	5.48 - 4.96
Power Consumption (Rated)	W		783 - 783	807 - 807	922 - 922	1,103 - 1,103
Power Factor (Rated)	%		92.0 - 92.1	92.6 - 92.6	95.9 - 96.0	96.8 - 96.7
SEER2 / HSPF2			19.50	10.00	19.50	10.00
EER2 (Rated)	Btu/h·W		11.50	—	11.50	—
COP2 (Rated)	W/W		—	3.96	—	3.56
Piping Connections	Liquid	in. (mm)	$\phi$ 1/4 (6.4)		$\phi$ 1/4 (6.4)	
	Gas	in. (mm)	$\phi$ 3/8 (9.5)		$\phi$ 3/8 (9.5)	
	Drain	in. (mm)	$\phi$ 5/8 (16)		$\phi$ 5/8 (16)	
Heat Insulation			Both Liquid and Gas Pipes		Both Liquid and Gas Pipes	
Max. Interunit Piping Length	ft (m)		65-5/8 (20)		65-5/8 (20)	
Max. Interunit Height Difference	ft (m)		49-1/4 (15)		49-1/4 (15)	
Chargeless	ft (m)		32-3/4 (10)		32-3/4 (10)	
Amount of Additional Charge of Refrigerant	oz/ft (g/m)		0.21 (20)		0.21 (20)	
<b>Indoor Unit</b>			<b>FTX09WMVJU9</b>		<b>FTX12WMVJU9</b>	
Front Panel Color			White (N9.5)		White (N9.5)	
Airflow Rate	H / M / L / SL	cfm	417 / 297 / 244 / 141	403 / 328 / 251 / 215	434 / 311 / 247 / 145	413 / 321 / 258 / 219
		m <sup>3</sup> /min	11.8 / 8.4 / 6.9 / 4.0	11.4 / 9.3 / 7.1 / 6.1	12.3 / 8.8 / 7.0 / 4.1	11.7 / 9.1 / 7.3 / 6.2
Fan	Type / Speed	Steps	Cross Flow Fan / 5 Steps, Quiet, Auto		Cross Flow Fan / 5 Steps, Quiet, Auto	
Air Direction Control			Right, Left, Horizontal, Downward		Right, Left, Horizontal, Downward	
Air Filter			Removable, Washable		Removable, Washable	
Running Current (Rated)	A		0.25 - 0.23	0.23 - 0.21	0.28 - 0.25	0.25 - 0.23
Power Consumption (Rated)	W		28 - 28	25 - 25	31 - 31	28 - 28
Power Factor (Rated)	%		53.8 - 52.9	52.3 - 51.8	53.2 - 53.9	53.8 - 52.9
Temperature Control			Microcomputer Control		Microcomputer Control	
Dimensions (H × W × D)	in. (mm)		11-1/4 × 30-5/16 × 8-3/4 (285 × 770 × 223)		11-1/4 × 30-5/16 × 8-3/4 (285 × 770 × 223)	
Packaged Dimensions (H × W × D)	in. (mm)		12-5/8 × 32-11/16 × 14-3/16 (320 × 830 × 360)		12-5/8 × 32-11/16 × 14-3/16 (320 × 830 × 360)	
Weight (Mass)	lbs (kg)		18 (8)		20 (9)	
Gross Weight (Gross Mass)	lbs (kg)		23 (11)		24 (11)	
Sound Pressure Level	H / M / L / SL	dB(A)	43 / 36 / 30 / 19	43 / 36 / 29 / 25	45 / 37 / 30 / 19	45 / 37 / 30 / 26
<b>Outdoor Unit</b>			<b>RXL09WMVJU9</b>		<b>RXL12WMVJU9</b>	
Casing Color			Ivory White		Ivory White	
Heat Exchanger	Fin Spec / Tube		Waffle Fin (PE) / $\phi$ 7 Hi-XSL Tube		Waffle Fin (PE) / $\phi$ 7 Hi-XSL Tube	
Fan Motor	Motor Output	HP	0.03		0.04	
Compressor	Type		Hermetically Sealed Swing Type		Hermetically Sealed Swing Type	
	Model		1YC23AUXD		2YC36PXD	
Refrigerant Oil	Type		FVC50K		FVC50K	
	Charge	oz (L)	12.68 (0.375)		21.98 (0.650)	
Refrigerant	Type		R-410A		R-410A	
	Charge	lbs (kg)	2.09 (0.95)		2.09 (0.95)	
Airflow Rate	cfm (m <sup>3</sup> /min)		1,105 (31.3)	922 (26.1)	1,144 (32.4)	1,031 (29.2)
Fan	Type		Propeller		Propeller	
Running Current (Rated)	A		3.84 - 3.47	3.96 - 3.58	4.34 - 3.93	5.23 - 4.73
Power Consumption (Rated)	W		755 - 755	782 - 782	891 - 891	1,075 - 1,075
Power Factor (Rated)	%		94.5 - 94.6	94.9 - 95.0	98.7 - 98.6	98.8 - 98.8
Dimensions (H × W × D)	in. (mm)		21-5/8 × 26-9/16 × 11-3/16 (550 × 675 × 284)		21-5/8 × 26-9/16 × 11-3/16 (550 × 675 × 284)	
Packaged Dimensions (H × W × D)	in. (mm)		23-13/16 × 31-7/16 × 14-11/16 (605 × 798 × 373)		23-13/16 × 31-7/16 × 14-11/16 (605 × 798 × 373)	
Weight (Mass)	lbs (kg)		63 (29)		73 (33)	
Gross Weight (Gross Mass)	lbs (kg)		68 (31)		78 (35)	
Sound Pressure Level	dB(A)		49	49	50	50
Conditions Based on	Indoor		80.0°FDB (26.7°CDB) / 67.0°FWB (19.4°CWB)	70.0°FDB (21.1°CDB) / 60.0°FWB (15.6°CWB)	80.0°FDB (26.7°CDB) / 67.0°FWB (19.4°CWB)	70.0°FDB (21.1°CDB) / 60.0°FWB (15.6°CWB)
	Outdoor		95.0°FDB (35.0°CDB) / 75.0°FWB (24.0°CWB)	47.0°FDB (8.3°CDB) / 43.0°FWB (6.1°CWB)	95.0°FDB (35.0°CDB) / 75.0°FWB (24.0°CWB)	47.0°FDB (8.3°CDB) / 43.0°FWB (6.1°CWB)
	Piping Length		25 ft (7.5 m)		25 ft (7.5 m)	
Drawing No.			3D143446		3D143446	
Note(s)			SL: The quiet fan level of the airflow rate setting.			

Conversion Formulae	
kcal/h = kW × 860	
Btu/h = kW × 3412	
cfm = m <sup>3</sup> /min × 35.3	

Model	Indoor Unit		FTX15WMVJU9		FTX18WMVJU9	
	Outdoor Unit		RXL15WMVJU9		RXL18WMVJU9	
			Cooling	Heating	Cooling	Heating
Power Supply			1 $\phi$ , 208 - 230 V, 60 Hz		1 $\phi$ , 208 - 230 V, 60 Hz	
Capacity Rated (Min. - Max.)			15,000 (5,800 - 18,400)	18,300 (5,800 - 24,600)	18,000 (9,000 - 21,600)	21,600 (9,000 - 28,000)
Running Current (Rated)			A 6.42 - 5.81	7.24 - 6.55	7.84 - 7.09	9.62 - 8.70
Power Consumption (Rated)			W 1,250 - 1,250	1,426 - 1,426	1,565 - 1,565	1,942 - 1,942
Power Factor (Rated)			% 93.6 - 93.5	94.7 - 94.6	96.0 - 96.0	97.1 - 97.0
SEER2 / HSPF2			19.50	10.00	19.80	8.50
EER2 (Rated)			Btu/h·W 12.00	—	11.50	—
COP2 (Rated)			W/W —	3.76	—	3.26
Piping Connections	Liquid	in. (mm)	$\phi$ 1/4 (6.4)		$\phi$ 1/4 (6.4)	
	Gas	in. (mm)	$\phi$ 1/2 (12.7)		$\phi$ 1/2 (12.7)	
	Drain	in. (mm)	$\phi$ 5/8 (16)		$\phi$ 5/8 (16)	
Heat Insulation			Both Liquid and Gas Pipes		Both Liquid and Gas Pipes	
Max. Interunit Piping Length			ft (m) 98-1/2 (30)		98-1/2 (30)	
Max. Interunit Height Difference			ft (m) 65-5/8 (20)		65-5/8 (20)	
Chargeless			ft (m) 32-3/4 (10)		32-3/4 (10)	
Amount of Additional Charge of Refrigerant			oz/ft (g/m) 0.21 (20)		0.32 (30)	
Indoor Unit			FTX15WMVJU9		FTX18WMVJU9	
Front Panel Color			White (N9.5)		White (N9.5)	
Airflow Rate	H / M / L / SL	cfm	593 / 505 / 431 / 367	653 / 554 / 470 / 399	583 / 484 / 385 / 360	713 / 583 / 431 / 399
		m <sup>3</sup> /min	16.8 / 14.3 / 12.2 / 10.4	18.5 / 15.7 / 13.3 / 11.3	16.5 / 13.7 / 10.9 / 10.2	20.2 / 16.5 / 12.2 / 11.3
Fan	Type / Speed	Steps	Cross Flow Fan / 5 Steps, Quiet, Auto		Cross Flow Fan / 5 Steps, Quiet, Auto	
Air Direction Control			Right, Left, Horizontal, Downward		Right, Left, Horizontal, Downward	
Air Filter			Removable, Washable		Removable, Washable	
Running Current (Rated)			A 0.23 - 0.21	0.25 - 0.23	0.40 - 0.37	0.51 - 0.48
Power Consumption (Rated)			W 33 - 33	38 - 38	47 - 47	61 - 61
Power Factor (Rated)			% 69.0 - 68.3	73.1 - 71.8	57.1 - 55.1	57.1 - 55.1
Temperature Control			Microcomputer Control		Microcomputer Control	
Dimensions (H x W x D)			in. (mm) 11-5/8 x 39 x 10-3/8 (295 x 990 x 263)		13-3/8 x 41-5/16 x 10-3/16 (340 x 1,050 x 259)	
Packaged Dimensions (H x W x D)			in. (mm) 15-3/16 x 43-3/8 x 15-5/16 (386 x 1,102 x 389)		13-7/16 x 45-11/16 x 16-7/8 (342 x 1,160 x 429)	
Weight (Mass)			lbs (kg) 27 (13)		33 (15)	
Gross Weight (Gross Mass)			lbs (kg) 36 (17)		42 (19)	
Sound Pressure Level	H / M / L / SL	dB(A)	45 / 41 / 36 / 33	45 / 41 / 37 / 33	46 / 41 / 36 / 33	48 / 42 / 35 / 32
Outdoor Unit			RXL15WMVJU9		RXL18WMVJU9	
Casing Color			Ivory White		Ivory White	
Heat Exchanger	Fin Spec / Tube		Waffle Fin (PE) / $\phi$ 7 Hi-XSL Tube		Waffle Fin (PE) / $\phi$ 7 Hi-XSL Tube	
Fan Motor	Motor Output	HP	0.12		0.16	
Compressor	Type		Hermetically Sealed Swing Type		Hermetically Sealed Swing Type	
	Model		2YC36PXD		2YC63AAXD	
Refrigerant Oil	Type		FVC50K		FVC50K	
	Charge	oz (L)	21.98 (0.650)		30.43 (0.900)	
Refrigerant	Type		R-410A		R-410A	
	Charge	lbs (kg)	3.20 (1.45)		3.53 (1.60)	
Airflow Rate		cfm (m <sup>3</sup> /min)	2,044 (57.9)	2,044 (57.9)	2,419 (68.5)	2,362 (66.9)
Fan	Type		Propeller		Propeller	
Running Current (Rated)			A 6.19 - 5.60	6.99 - 6.32	7.44 - 6.72	9.11 - 8.22
Power Consumption (Rated)			W 1,217 - 1,217	1,388 - 1,388	1,518 - 1,518	1,881 - 1,881
Power Factor (Rated)			% 94.5 - 94.5	95.5 - 95.5	98.1 - 98.2	99.3 - 99.5
Dimensions (H x W x D)			in. (mm) 28-15/16 x 34-1/4 x 12-5/8 (735 x 870 x 320)		28-15/16 x 34-1/4 x 12-5/8 (735 x 870 x 320)	
Packaged Dimensions (H x W x D)			in. (mm) 31-7/8 x 41-9/16 x 18-1/4 (810 x 1,056 x 464)		31-7/8 x 41-9/16 x 18-1/4 (810 x 1,056 x 464)	
Weight (Mass)			lbs (kg) 109 (50)		132 (60)	
Gross Weight (Gross Mass)			lbs (kg) 119 (54)		142 (65)	
Sound Pressure Level			50	55	54	55
Conditions Based on	Indoor		80.0°FDB (26.7°CDB) / 67.0°FWB (19.4°CWB)	70.0°FDB (21.1°CDB) / 60.0°FWB (15.6°CWB)	80.0°FDB (26.7°CDB) / 67.0°FWB (19.4°CWB)	70.0°FDB (21.1°CDB) / 60.0°FWB (15.6°CWB)
	Outdoor		95.0°FDB (35.0°CDB) / 75.0°FWB (24.0°CWB)	47.0°FDB (8.3°CDB) / 43.0°FWB (6.1°CWB)	95.0°FDB (35.0°CDB) / 75.0°FWB (24.0°CWB)	47.0°FDB (8.3°CDB) / 43.0°FWB (6.1°CWB)
	Piping Length		25 ft (7.5 m)		25 ft (7.5 m)	
Drawing No.			3D143446		3D143445A	
Note(s)			SL: The quiet fan level of the airflow rate setting.			

Conversion Formulae	
kcal/h	= kW x 860
Btu/h	= kW x 3412
cfm	= m <sup>3</sup> /min x 35.3

Model	Indoor Unit		FTX24WVJU9	
	Outdoor Unit		RXL24WMVJU9	
			Cooling	Heating
Power Supply			1 $\phi$ , 208 - 230 V, 60 Hz	
Capacity Rated (Min. - Max.)		Btu/h	21,200 (9,000 - 25,800)	24,000 (9,000 - 32,000)
Running Current (Rated)		A	9.23 - 8.35	11.39 - 10.30
Power Consumption (Rated)		W	1,843 - 1,843	2,299 - 2,299
Power Factor (Rated)		%	96.0 - 96.0	97.0 - 97.0
SEER2 / HSPF2			19.50	8.50
EER2 (Rated)		Btu/h-W	11.50	—
COP2 (Rated)		W/W	—	3.06
Piping Connections	Liquid	in. (mm)	$\phi$ 1/4 (6.4)	
	Gas	in. (mm)	$\phi$ 5/8 (15.9)	
	Drain	in. (mm)	$\phi$ 5/8 (16)	
Heat Insulation			Both Liquid and Gas Pipes	
Max. Interunit Piping Length		ft (m)	98-1/2 (30)	
Max. Interunit Height Difference		ft (m)	65-5/8 (20)	
Chargeless		ft (m)	32-3/4 (10)	
Amount of Additional Charge of Refrigerant		oz/ft (g/m)	0.32 (30)	
<b>Indoor Unit</b>			<b>FTX24WVJU9</b>	
Front Panel Color			White (N9.5)	
Airflow Rate	H / M / L / SL	cfm	643 / 494 / 350 / 328	699 / 572 / 445 / 403
		m <sup>3</sup> /min	18.2 / 14.0 / 9.9 / 9.3	19.8 / 16.2 / 12.6 / 11.4
Fan	Type / Speed	Steps	Cross Flow Fan / 5 Steps, Quiet, Auto	
Air Direction Control			Right, Left, Horizontal, Downward	
Air Filter			Removable, Washable	
Running Current (Rated)		A	0.64 - 0.58	0.63 - 0.57
Power Consumption (Rated)		W	78 - 78	76 - 76
Power Factor (Rated)		%	58.2 - 58.0	58.2 - 58.0
Temperature Control			Microcomputer Control	
Dimensions (H x W x D)		in. (mm)	13-3/8 x 41-5/16 x 10-3/16 (340 x 1,050 x 259)	
Packaged Dimensions (H x W x D)		in. (mm)	13-7/16 x 45-11/16 x 16-7/8 (342 x 1,160 x 429)	
Weight (Mass)		lbs (kg)	33 (15)	
Gross Weight (Gross Mass)		lbs (kg)	44 (20)	
Sound Pressure Level	H / M / L / SL	dB(A)	51 / 44 / 37 / 34	48 / 42 / 37 / 34
<b>Outdoor Unit</b>			<b>RXL24WMVJU9</b>	
Casing Color			Ivory White	
Heat Exchanger	Fin Spec / Tube		Waffle Fin (PE) / $\phi$ 7 Hi-XSL Tube	
Fan Motor	Motor Output	HP	0.16	
Compressor	Type		Hermetically Sealed Swing Type	
	Model		2YC63AAXD	
Refrigerant Oil	Type		FVC50K	
	Charge	oz (L)	30.43 (0.900)	
Refrigerant	Type		R-410A	
	Charge	lbs (kg)	3.53 (1.60)	
Airflow Rate		cfm (m <sup>3</sup> /min)	2,419 (68.5)	2,362 (66.9)
Fan	Type		Propeller	
Running Current (Rated)		A	8.59 - 7.77	10.76 - 9.73
Power Consumption (Rated)		W	1,765 - 1,765	2,223 - 2,223
Power Factor (Rated)		%	98.8 - 98.8	99.3 - 99.3
Dimensions (H x W x D)		in. (mm)	28-15/16 x 34-1/4 x 12-5/8 (735 x 870 x 320)	
Packaged Dimensions (H x W x D)		in. (mm)	31-7/8 x 41-9/16 x 18-1/4 (810 x 1,056 x 464)	
Weight (Mass)		lbs (kg)	132 (60)	
Gross Weight (Gross Mass)		lbs (kg)	142 (65)	
Sound Pressure Level		dB(A)	55	55
Conditions Based on	Indoor	80.0°FDB (26.7°CDB) / 67.0°FWB (19.4°CWB)		70.0°FDB (21.1°CDB) / 60.0°FWB (15.6°CWB)
	Outdoor	95.0°FDB (35.0°CDB) / 75.0°FWB (24.0°CWB)		47.0°FDB (8.3°CDB) / 43.0°FWB (6.1°CWB)
Piping Length		25 ft (7.5 m)		
Drawing No.			3D143445A	
Note(s)			SL: The quiet fan level of the airflow rate setting.	

Conversion Formulae	
kcal/h = kW x 860	
Btu/h = kW x 3412	
cfm = m <sup>3</sup> /min x 35.3	



Model	Indoor Unit		FVXS09WVJU9		FVXS12WVJU9	
	Outdoor Unit		RXL09WMVJU9		RXL12WMVJU9	
			Cooling	Heating	Cooling	Heating
Power Supply			1 $\phi$ , 208 - 230 V, 60 Hz		1 $\phi$ , 208 - 230 V, 60 Hz	
Capacity Rated (Min. - Max.)			Btu/h 9,000 (4,400 - 10,200)		10,100 (4,400 - 14,300)	
Running Current (Rated)			A 4.08 - 3.69		3.91 - 3.54	
Power Consumption (Rated)			W 783 - 783		767 - 767	
Power Factor (Rated)			%		92.3 - 92.3	
SEER2 / HSPF2			19.50		9.70	
EER2 (Rated)			Btu/h·W 11.50		—	
COP2 (Rated)			W/W		—	
Piping Connections			Liquid in. (mm)		$\phi$ 1/4 (6.4)	
			Gas in. (mm)		$\phi$ 3/8 (9.5)	
			Drain in. (mm)		$\phi$ 13/16 (20)	
Heat Insulation			Both Liquid and Gas Pipes		Both Liquid and Gas Pipes	
Max. Interunit Piping Length			ft (m)		65-5/8 (20)	
Max. Interunit Height Difference			ft (m)		49-1/4 (15)	
Chargeless			ft (m)		32-3/4 (10)	
Amount of Additional Charge of Refrigerant			oz/ft (g/m)		0.21 (20)	
Indoor Unit			FVXS09WVJU9		FVXS12WVJU9	
Front Panel Color			White (B-272)		White (B-272)	
Airflow Rate			H / M / L / SL		cfm	
					m <sup>3</sup> /min	
Fan			Type / Speed		Steps	
Air Direction Control			Turbo Fan / 5 Steps, Quiet, Auto		Turbo Fan / 5 Steps, Quiet, Auto	
Air Filter			Right, Left, Horizontal, Downward		Right, Left, Horizontal, Downward	
Running Current (Rated)			Removable, Washable, Mildew Proof		Removable, Washable, Mildew Proof	
Power Consumption (Rated)			A		0.14 - 0.13	
Power Factor (Rated)			W		15 - 15	
Temperature Control			%		51.5 - 50.2	
Dimensions (H x W x D)			Microcomputer Control		Microcomputer Control	
Packaged Dimensions (H x W x D)			in. (mm)		23-5/8 x 27-9/16 x 8-1/4 (600 x 700 x 210)	
Weight (Mass)			lbs (kg)		31 (14)	
Gross Weight (Gross Mass)			lbs (kg)		38 (17)	
Sound Pressure Level			H / M / L / SL		dB(A)	
Outdoor Unit			RXL09WMVJU9		RXL12WMVJU9	
Casing Color			Ivory White		Ivory White	
Heat Exchanger			Fin Spec / Tube		Waffle Fin (PE) / $\phi$ 7 Hi-XSL Tube	
Fan Motor			Motor Output		HP	
Compressor			Type		Hermetically Sealed Swing Type	
Refrigerant Oil			Model		1YC23AUXD	
Refrigerant			Type		2YC36PXD	
Refrigerant			Charge		oz (L)	
Refrigerant			Type		FVC50K	
Refrigerant			Charge		lbs (kg)	
Airflow Rate			cfm		1,105 (31.3)	
Fan			Type		Propeller	
Running Current (Rated)			A		3.94 - 3.56	
Power Consumption (Rated)			W		768 - 768	
Power Factor (Rated)			%		93.7 - 93.8	
Dimensions (H x W x D)			in. (mm)		21-5/8 x 26-9/16 x 11-3/16 (550 x 675 x 284)	
Packaged Dimensions (H x W x D)			in. (mm)		23-13/16 x 31-7/16 x 14-11/16 (605 x 798 x 373)	
Weight (Mass)			lbs (kg)		63 (29)	
Gross Weight (Gross Mass)			lbs (kg)		68 (31)	
Sound Pressure Level			dB(A)		49	
Conditions Based on			Indoor		80.0°FDB (26.7°CDB) / 67.0°FWB (19.4°CWB)	
			Outdoor		70.0°FDB (21.1°CDB) / 60.0°FWB (15.6°CWB)	
			Piping Length		25 ft (7.5 m)	
Drawing No.			3D143142B		3D143142B	
Note(s)			SL: The quiet fan level of the airflow rate setting.			

Conversion Formulae	
kcal/h	= kW x 860
Btu/h	= kW x 3412
cfm	= m <sup>3</sup> /min x 35.3

Model	Indoor Unit		FVXS15WVJU9	
	Outdoor Unit		RXL15WMVJU9	
			Cooling	Heating
Power Supply			1 φ, 208 - 230 V, 60 Hz	
Capacity Rated (Min. - Max.)		Btu/h	15,000 (5,800 - 17,100)	18,000 (5,800 - 24,000)
Running Current (Rated)		A	6.59 - 5.96	7.49 - 6.77
Power Consumption (Rated)		W	1,304 - 1,304	1,499 - 1,499
Power Factor (Rated)		%	95.1 - 95.2	96.2 - 96.2
SEER2 / HSPF2			19.50	9.30
EER2 (Rated)		Btu/h·W	11.50	—
COP2 (Rated)		W/W	—	3.52
Piping Connections	Liquid	in. (mm)	φ 1/4 (6.4)	
	Gas	in. (mm)	φ 1/2 (12.7)	
	Drain	in. (mm)	φ 13/16 (20)	
Heat Insulation			Both Liquid and Gas Pipes	
Max. Interunit Piping Length		ft (m)	98-1/2 (30)	
Max. Interunit Height Difference		ft (m)	65-5/8 (20)	
Chargeless		ft (m)	32-3/4 (10)	
Amount of Additional Charge of Refrigerant		oz/ft (g/m)	0.21 (20)	
Indoor Unit			FVXS15WVJU9	
Front Panel Color			White (B-272)	
Airflow Rate	H / M / L / SL	cfm	378 / 325 / 275 / 233	417 / 357 / 300 / 251
		m <sup>3</sup> /min	10.7 / 9.2 / 7.8 / 6.6	11.8 / 10.1 / 8.5 / 7.1
Fan	Type / Speed	Steps	Turbo Fan / 5 Steps, Quiet, Auto	
Air Direction Control			Right, Left, Horizontal, Downward	
Air Filter			Removable, Washable, Mildew Proof	
Running Current (Rated)		A	0.19 - 0.17	0.21 - 0.19
Power Consumption (Rated)		W	27 - 27	34 - 34
Power Factor (Rated)		%	68.3 - 69.1	77.8 - 77.8
Temperature Control			Microcomputer Control	
Dimensions (H × W × D)		in. (mm)	23-5/8 × 27-9/16 × 8-1/4 (600 × 700 × 210)	
Packaged Dimensions (H × W × D)		in. (mm)	27-3/8 × 30-15/16 × 11 (696 × 786 × 280)	
Weight (Mass)		lbs (kg)	31 (14)	
Gross Weight (Gross Mass)		lbs (kg)	38 (17)	
Sound Pressure Level	H / M / L / SL	dB(A)	44 / 40 / 36 / 32	45 / 40 / 36 / 32
Outdoor Unit			RXL15WMVJU9	
Casing Color			Ivory White	
Heat Exchanger	Fin Spec / Tube		Waffle Fin (PE) / φ 7 Hi-XSL Tube	
Fan Motor	Motor Output	HP	0.12	
Compressor	Type		Hermetically Sealed Swing Type	
	Model		2YC36PXD	
Refrigerant Oil	Type		FVC50K	
	Charge	oz (L)	21.98 (0.650)	
Refrigerant	Type		R-410A	
	Charge	lbs (kg)	3.20 (1.45)	
Airflow Rate		cfm (m <sup>3</sup> /min)	2,044 (57.9)	2,044 (57.9)
Fan	Type		Propeller	
Running Current (Rated)		A	6.40 - 5.79	7.28 - 6.58
Power Consumption (Rated)		W	1,277 - 1,277	1,465 - 1,465
Power Factor (Rated)		%	95.9 - 95.9	96.7 - 96.8
Dimensions (H × W × D)		in. (mm)	28-15/16 × 34-1/4 × 12-5/8 (735 × 870 × 320)	
Packaged Dimensions (H × W × D)		in. (mm)	31-7/8 × 41-9/16 × 18-1/4 (810 × 1,056 × 464)	
Weight (Mass)		lbs (kg)	109 (50)	
Gross Weight (Gross Mass)		lbs (kg)	119 (54)	
Sound Pressure Level		dB(A)	50	55
Conditions Based on	Indoor		80.0°FDB (26.7°CDB) / 67.0°FWB (19.4°CWB)	70.0°FDB (21.1°CDB) / 60.0°FWB (15.6°CWB)
	Outdoor		95.0°FDB (35.0°CDB) / 75.0°FWB (24.0°CWB)	47.0°FDB (8.3°CDB) / 43.0°FWB (6.1°CWB)
	Piping Length		25 ft (7.5 m)	
Drawing No.			3D143142A	
Note(s)			SL: The quiet fan level of the airflow rate setting.	

Conversion Formulae
kcal/h = kW × 860
Btu/h = kW × 3412
cfm = m <sup>3</sup> /min × 35.3

Model	Indoor Unit		FDMQ12WVJU9		FDMQ18WVJU9	
	Outdoor Unit		RXL12WMVJU9		RXL18WMVJU9	
			Cooling	Heating	Cooling	Heating
Power Supply			1 ϕ, 208 - 230 V, 60 Hz		1 ϕ, 208 - 230 V, 60 Hz	
Capacity Rated (Min. - Max.)			10,800 (6,500 - 12,400)		17,600 (9,000 - 19,600)	
Running Current (Rated)			5.90 - 5.34		8.79 - 7.95	
Power Consumption (Rated)			1,213 - 1,213		1,760 - 1,760	
Power Factor (Rated)			98.8 - 98.8		96.3 - 96.2	
SEER2 / HSPF2			14.60		15.20	
EER2 (Rated)			8.90		10.00	
COP2 (Rated)			—		—	
Piping Connections	Liquid	in. (mm)	ϕ 1/4 (6.4)		ϕ 1/4 (6.4)	
	Gas	in. (mm)	ϕ 3/8 (9.5)		ϕ 1/2 (12.7)	
	Drain	in. (mm)	I.D. ϕ 1 (25) / O.D. ϕ 1-1/4 (32)		I.D. ϕ 1 (25) / O.D. ϕ 1-1/4 (32)	
Heat Insulation			Both Liquid and Gas Pipes		Both Liquid and Gas Pipes	
Max. Interunit Piping Length			65-5/8 (20)		98-1/2 (30)	
Max. Interunit Height Difference			49-1/4 (15)		65-5/8 (20)	
Chargeless			32-3/4 (10)		32-3/4 (10)	
Amount of Additional Charge of Refrigerant			0.21 (20)		0.32 (30)	
<b>Indoor Unit</b>			<b>FDMQ12WVJU9</b>		<b>FDMQ18WVJU9</b>	
Heat Exchanger	Rows × Stages, Fin per Inch		3 × 26, 18		3 × 26, 18	
	Fin Spec / Tube		Multi Slit Fin / ϕ 5 Hi-XA Tube		Multi Slit Fin / ϕ 5 Hi-XA Tube	
Airflow Rate	H / M / L	cfm	371 / 318 / 261		614 / 523 / 431	
		m <sup>3</sup> /min	10.5 / 9.0 / 7.4		17.4 / 14.8 / 12.2	
Fan Motor	H / M / L	rpm	1,089 / 930 / 771		1,023 / 870 / 717	
		Motor Output	HP		0.17	
Fan	Type		Sirocco Fan		Sirocco Fan	
External Static Pressure	inH <sub>2</sub> O		Standard 0.20 (0.60 - 0.12)		Standard 0.20 (0.60 - 0.20)	
	Pa		Standard 50 (150 - 30)		Standard 50 (150 - 50)	
Running Current (Rated)			0.44 - 0.40		0.69 - 0.62	
Power Consumption (Rated)			89 - 89		131 - 131	
Power Factor (Rated)			97.0 - 97.6		91.2 - 92.2	
Temperature Control			Microcomputer Control		Microcomputer Control	
Dimensions (H × W × D)			in. (mm) 9-5/8 × 27-9/16 × 31-1/2 (245 × 700 × 800)		9-5/8 × 39-3/8 × 31-1/2 (245 × 1,000 × 800)	
Packaged Dimensions (H × W × D)			in. (mm) 11-9/16 × 35-3/8 × 34-7/8 (293 × 899 × 886)		11-9/16 × 47-3/16 × 34-7/8 (293 × 1,199 × 886)	
Weight (Mass)			lbs (kg) 64 (29)		82 (37)	
Gross Weight (Gross Mass)			lbs (kg) 71 (32)		88 (40)	
Sound Pressure Level			33		35	
Remote Controller (Option)	Wired		BRC1E73		BRC1E73	
	Wireless		BRC082A43		BRC082A43	
<b>Outdoor Unit</b>			<b>RXL12WMVJU9</b>		<b>RXL18WMVJU9</b>	
Casing Color			Ivory White		Ivory White	
Heat Exchanger			Waffle Fin (PE) / ϕ 7 Hi-XSL Tube		Waffle Fin (PE) / ϕ 7 Hi-XSL Tube	
Fan Motor			Motor Output HP		0.04	
Compressor	Type		Hermetically Sealed Swing Type		Hermetically Sealed Swing Type	
	Model		2YC36PXD		2YC63AAXD	
Refrigerant Oil	Type		FVC50K		FVC50K	
	Charge		oz (L) 21.98 (0.650)		30.43 (0.900)	
Refrigerant	Type		R-410A		R-410A	
	Charge		lbs (kg) 2.09 (0.95)		3.53 (1.60)	
Airflow Rate			cfm (m <sup>3</sup> /min) 1,144 (32.4)		1,031 (29.2)	
Fan			Propeller		Propeller	
Running Current (Rated)			A 5.46 - 4.94		8.10 - 7.33	
Power Consumption (Rated)			W 1,124 - 1,124		1,629 - 1,629	
Power Factor (Rated)			% 99.0 - 98.9		96.7 - 96.6	
Dimensions (H × W × D)			in. (mm) 21-5/8 × 26-9/16 × 11-3/16 (550 × 675 × 284)		28-15/16 × 34-1/4 × 12-5/8 (735 × 870 × 320)	
Packaged Dimensions (H × W × D)			in. (mm) 23-13/16 × 31-7/16 × 14-11/16 (605 × 798 × 373)		31-7/8 × 41-9/16 × 18-1/4 (810 × 1,056 × 464)	
Weight (Mass)			lbs (kg) 73 (33)		132 (60)	
Gross Weight (Gross Mass)			lbs (kg) 78 (35)		142 (65)	
Sound Pressure Level			50		54	
Conditions Based on	Indoor		80.0°FDB (26.7°CDB) / 67.0°FWB (19.4°CWB)		80.0°FDB (26.7°CDB) / 67.0°FWB (19.4°CWB)	
	Outdoor		70.0°FDB (21.1°CDB) / 60.0°FWB (15.6°CWB)		70.0°FDB (21.1°CDB) / 60.0°FWB (15.6°CWB)	
	Piping Length		47.0°FDB (8.3°CDB) / 43.0°FWB (6.1°CWB)		47.0°FDB (8.3°CDB) / 43.0°FWB (6.1°CWB)	
Drawing No.			C: 3D143347		3D143347	
Note(s)			SL: The quiet fan level of the airflow rate setting. External static pressure is changeable in 13 (FDMQ12WVJU9), 11 (FDMQ18WVJU9) stages by remote controller. Air filter is not standard accessory, but please mount it in the duct system of the suction side. Select its dust collection efficiency (gravity method) 50% or more.			

Conversion Formulae
kcal/h = kW × 860
Btu/h = kW × 3412
cfm = m <sup>3</sup> /min × 35.3

Model	Indoor Unit		FDMQ24WVJU9	
	Outdoor Unit		RXL24WMVJU9	
			Cooling	Heating
Power Supply			1 $\phi$ , 208 - 230 V, 60 Hz	
Capacity Rated (Min. - Max.)	Btu/h		21,200 (9,000 - 23,000)	24,000 (9,000 - 27,600)
Running Current (Rated)	A		10.74 - 9.71	11.41 - 10.32
Power Consumption (Rated)	W		2,208 - 2,208	2,345 - 2,345
Power Factor (Rated)	%		98.8 - 98.9	98.8 - 98.8
SEER2 / HSPF2			15.20	8.40
EER2 (Rated)	Btu/h·W		9.60	—
COP2 (Rated)	W/W		—	3.00
Piping Connections	Liquid	in. (mm)	$\phi$ 1/4 (6.4)	
	Gas	in. (mm)	$\phi$ 5/8 (15.9)	
	Drain	in. (mm)	I.D. $\phi$ 1 (25) / O.D. $\phi$ 1-1/4 (32)	
Heat Insulation			Both Liquid and Gas Pipes	
Max. Interunit Piping Length	ft (m)		98-1/2 (30)	
Max. Interunit Height Difference	ft (m)		65-5/8 (20)	
Chargeless	ft (m)		32-3/4 (10)	
Amount of Additional Charge of Refrigerant	oz/ft (g/m)		0.32 (30)	
<b>Indoor Unit</b>			<b>FDMQ24WVJU9</b>	
Heat Exchanger	Rows $\times$ Stages, Fin per Inch		3 $\times$ 26, 18	
	Fin Spec / Tube		Multi Slit Fin / $\phi$ 5 Hi-XA Tube	
Airflow Rate	H / M / L	cfm	731 / 621 / 512	731 / 621 / 512
		m <sup>3</sup> /min	20.7 / 17.6 / 14.5	20.7 / 17.6 / 14.5
Fan Motor	H / M / L	rpm	1,119 / 951 / 783	1,119 / 951 / 783
		Motor Output	HP	0.31
Fan	Type		Sirocco Fan	
External Static Pressure	inH <sub>2</sub> O		Standard 0.20 (0.60 - 0.20)	
	Pa		Standard 50 (150 - 50)	
Running Current (Rated)	A		0.82 - 0.74	0.82 - 0.74
Power Consumption (Rated)	W		167 - 167	167 - 167
Power Factor (Rated)	%		97.8 - 97.5	97.8 - 97.5
Temperature Control			Microcomputer Control	
Dimensions (H $\times$ W $\times$ D)	in. (mm)		9-5/8 $\times$ 39-3/8 $\times$ 31-1/2 (245 $\times$ 1,000 $\times$ 800)	
Packaged Dimensions (H $\times$ W $\times$ D)	in. (mm)		11-9/16 $\times$ 47-3/16 $\times$ 34-7/8 (293 $\times$ 1,199 $\times$ 886)	
Weight (Mass)	lbs (kg)		82 (37)	
Gross Weight (Gross Mass)	lbs (kg)		88 (40)	
Sound Pressure Level	dB(A)		40	40
Remote Controller (Option)	Wired		BRC1E73	
	Wireless		BRC082A43	
<b>Outdoor Unit</b>			<b>RXL24WMVJU9</b>	
Casing Color			Ivory White	
Heat Exchanger	Fin Spec / Tube		Waffle Fin (PE) / $\phi$ 7 Hi-XSL Tube	
Fan Motor	Motor Output	HP	0.16	
Compressor	Type		Hermetically Sealed Swing Type	
	Model		2YC63AAXD	
Refrigerant Oil	Type		FVC50K	
	Charge	oz (L)	30.43 (0.900)	
Refrigerant	Type		R-410A	
	Charge	lbs (kg)	3.53 (1.60)	
Airflow Rate	cfm (m <sup>3</sup> /min)		2,419 (68.5)	2,362 (66.9)
Fan	Type		Propeller	
Running Current (Rated)	A		9.92 - 8.97	10.59 - 9.58
Power Consumption (Rated)	W		2,041 - 2,041	2,178 - 2,178
Power Factor (Rated)	%		98.9 - 98.9	98.9 - 98.8
Dimensions (H $\times$ W $\times$ D)	in. (mm)		28-15/16 $\times$ 34-1/4 $\times$ 12-5/8 (735 $\times$ 870 $\times$ 320)	
Packaged Dimensions (H $\times$ W $\times$ D)	in. (mm)		31-7/8 $\times$ 41-9/16 $\times$ 18-1/4 (810 $\times$ 1,056 $\times$ 464)	
Weight (Mass)	lbs (kg)		132 (60)	
Gross Weight (Gross Mass)	lbs (kg)		142 (65)	
Sound Pressure Level	dB(A)		55	55
Conditions Based on	Indoor		80.0°FDB (26.7°CDB) / 67.0°FWB (19.4°CWB)	70.0°FDB (21.1°CDB) / 60.0°FWB (15.6°CWB)
	Outdoor		95.0°FDB (35.0°CDB) / 75.0°FWB (24.0°CWB)	47.0°FDB (8.3°CDB) / 43.0°FWB (6.1°CWB)
	Piping Length		25 ft (7.5 m)	
Drawing No.			3D143347	
Note(s)	SL: The quiet fan level of the airflow rate setting. External static pressure is changeable in 11 stages by remote controller. Air filter is not standard accessory, but please mount it in the duct system of the suction side. Select its dust collection efficiency (gravity method) 50% or more.			

Conversion Formulae
kcal/h = kW $\times$ 860
Btu/h = kW $\times$ 3412
cfm = m <sup>3</sup> /min $\times$ 35.3

# 4. Dimensions

## 4.1 Indoor Unit FTX09/12WMVJU9

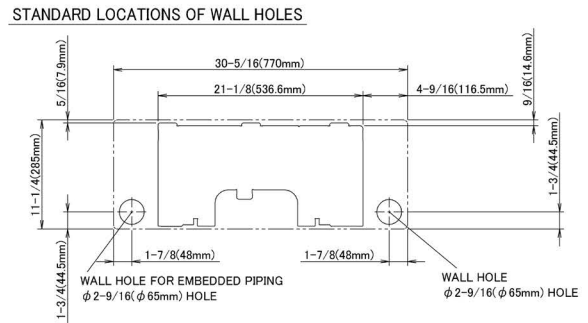
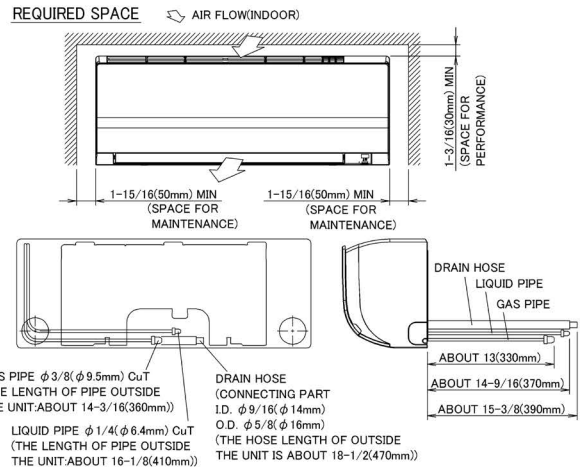
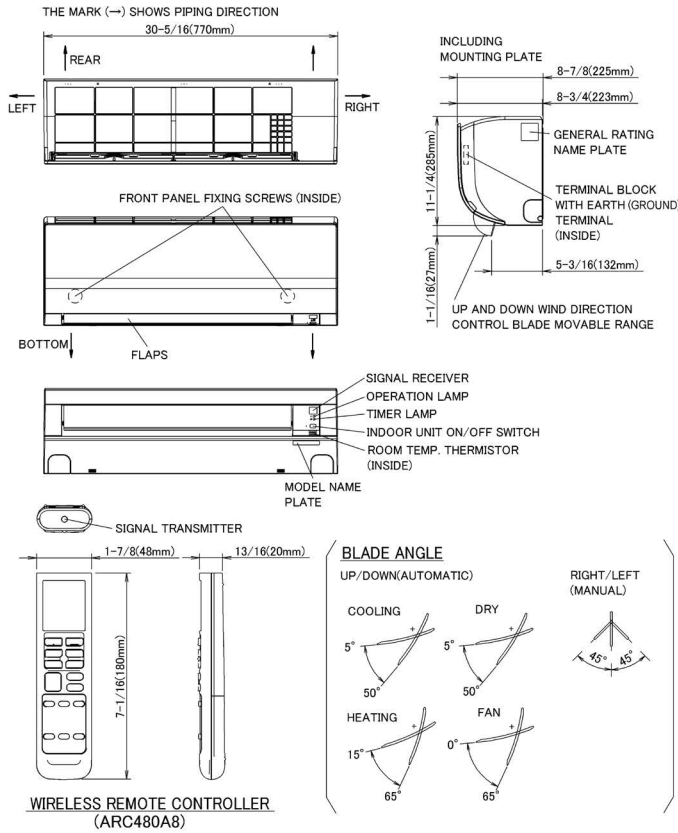

C: 3D091702A

## FTX15WMVJU9

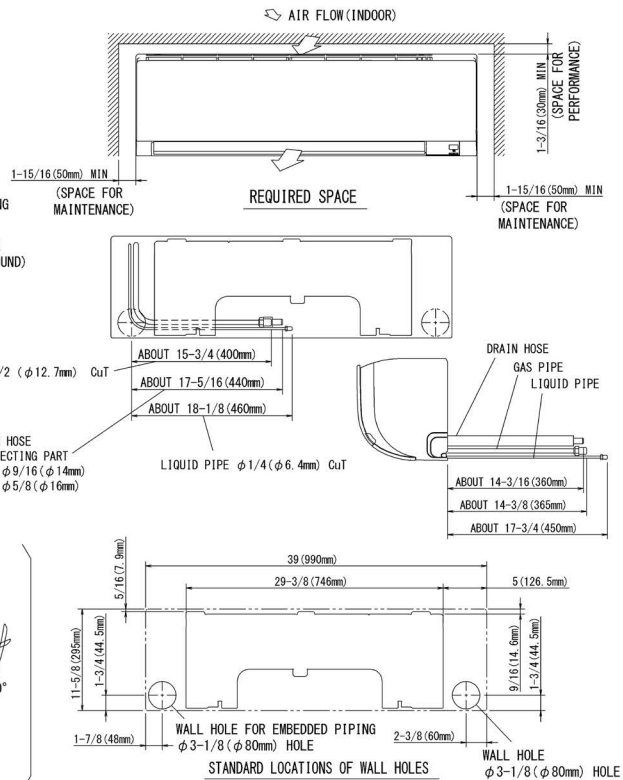
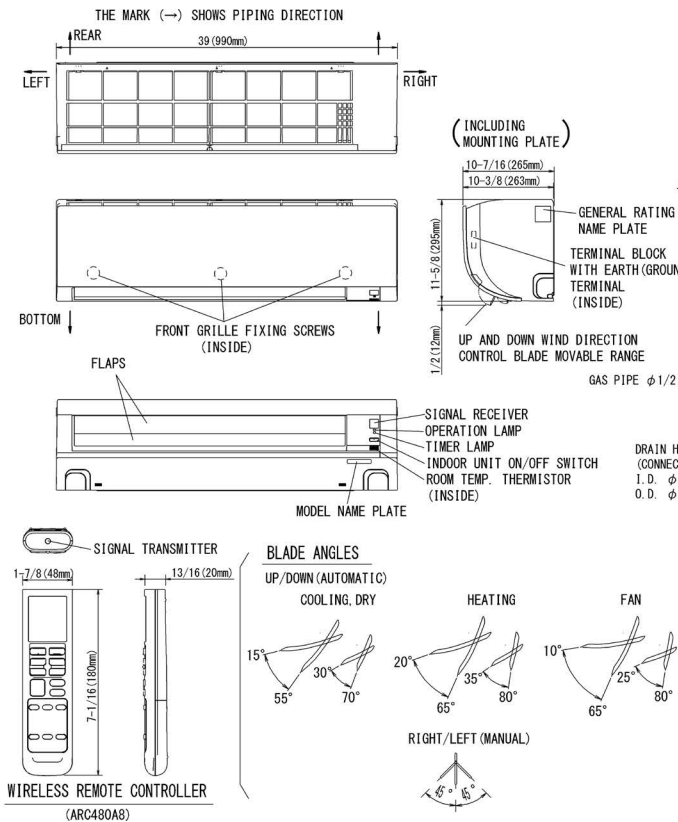

3D091779C

**FTX18WVJU9**

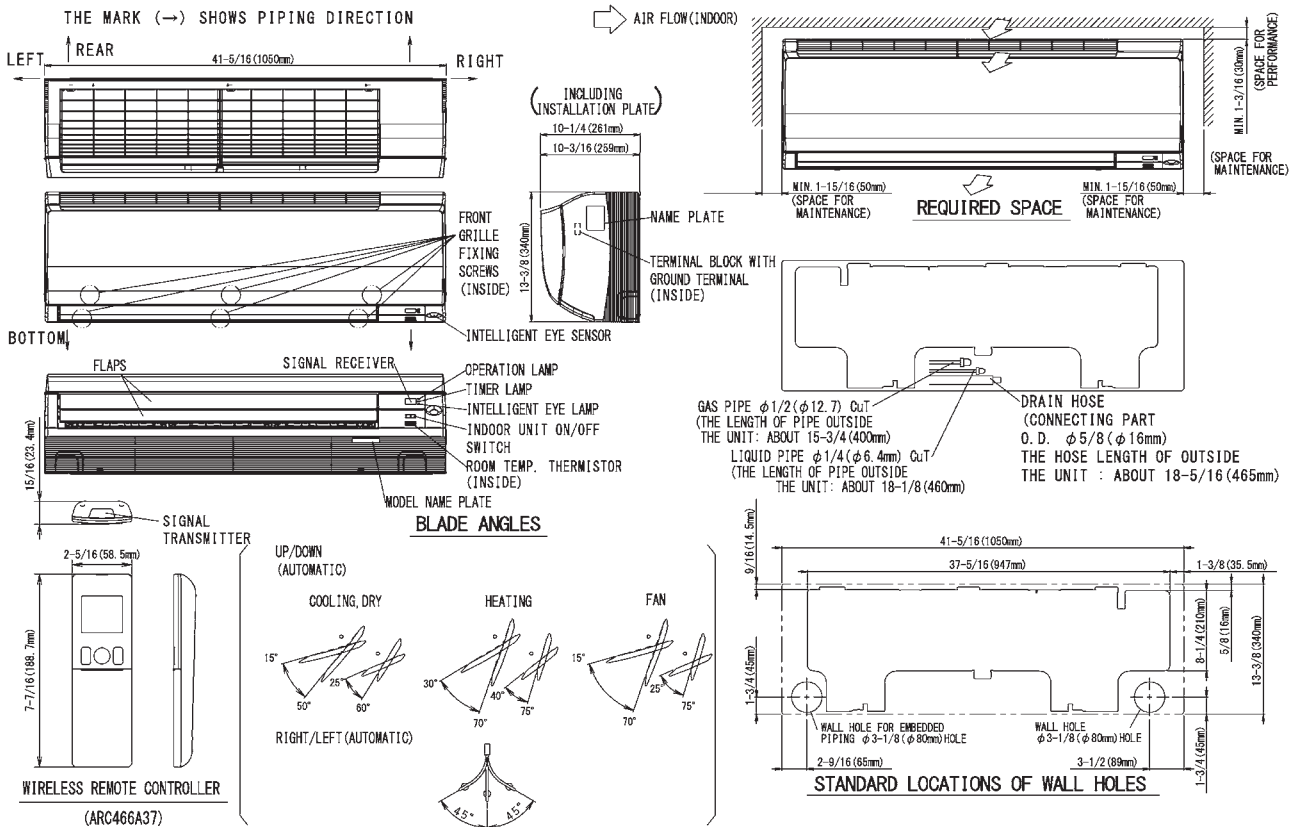

C: 3D123379

**FTX24WVJU9**

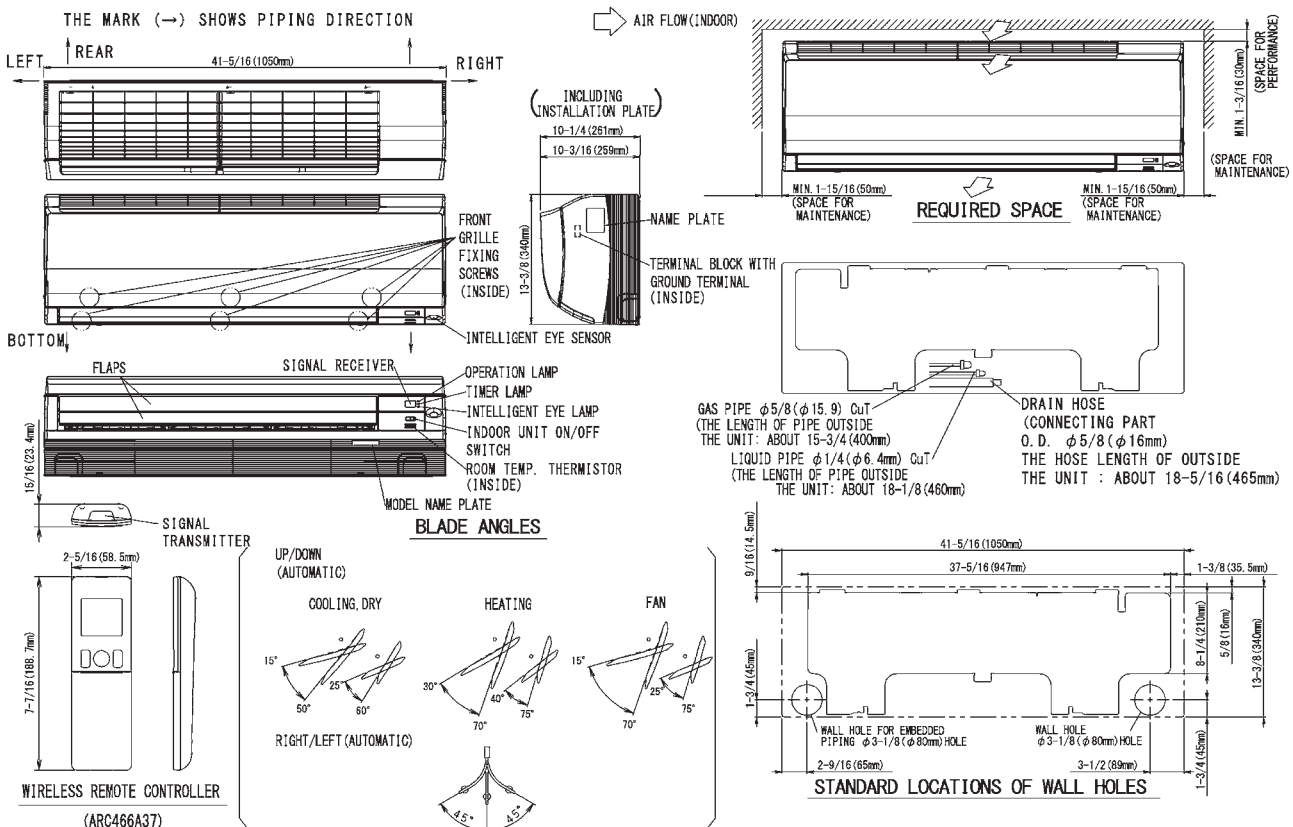

C: 3D123383



FVXS09/12WVJU9

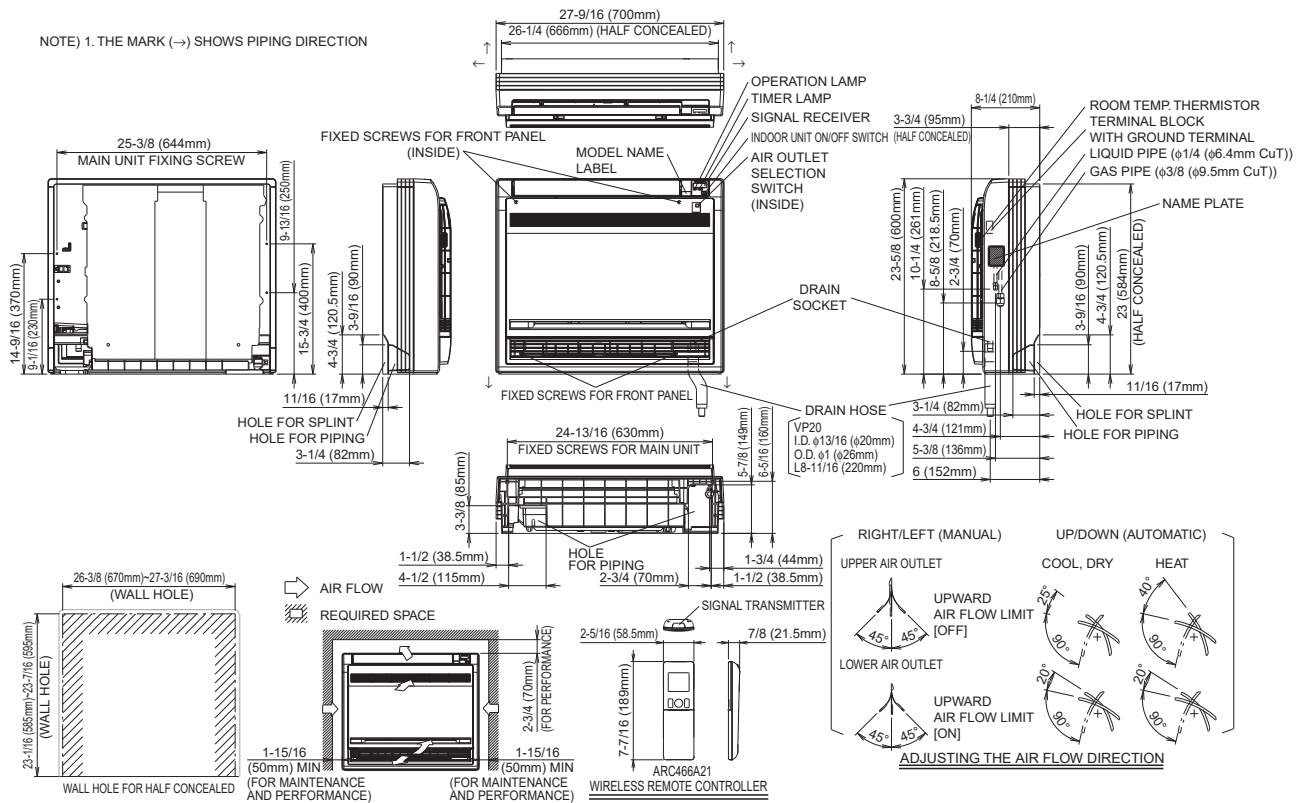

3D091758A

FVXS15WVJU9

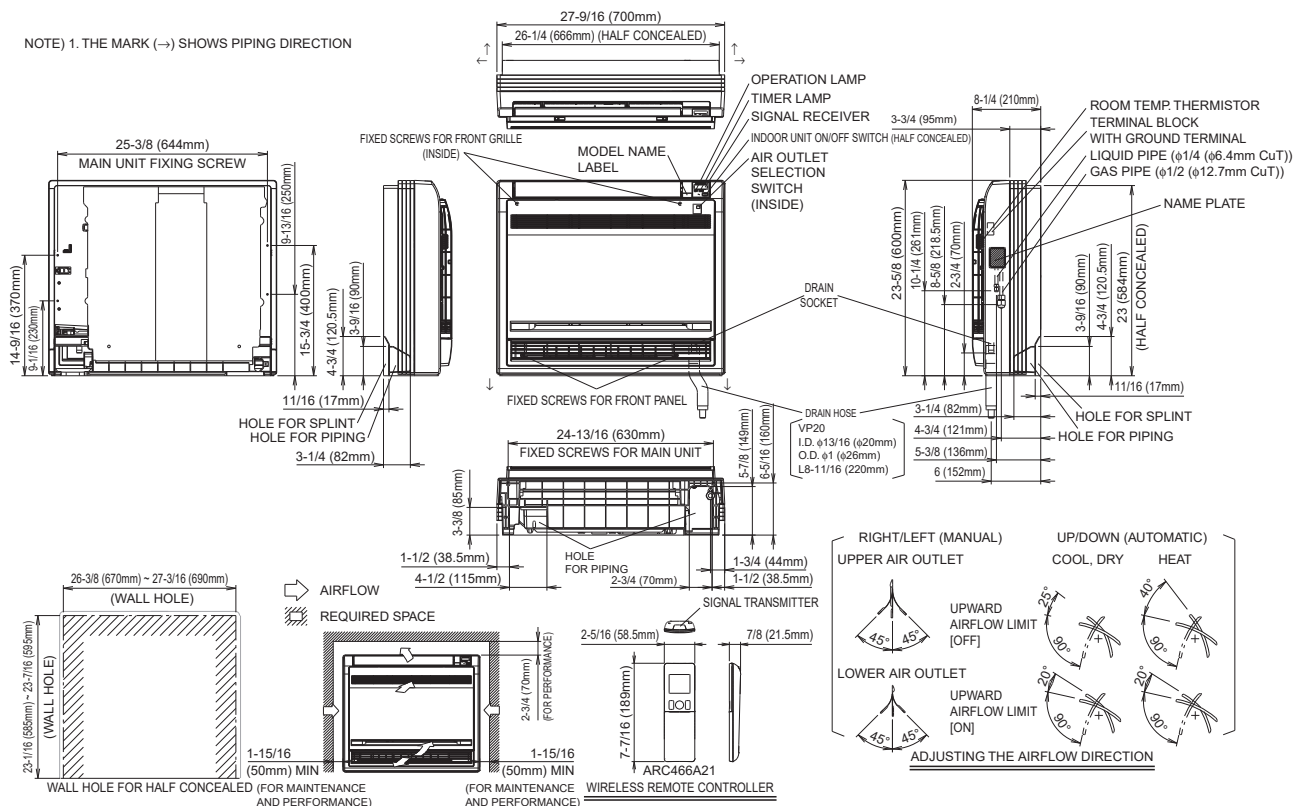

3D091774B

FDMQ12WVJU9

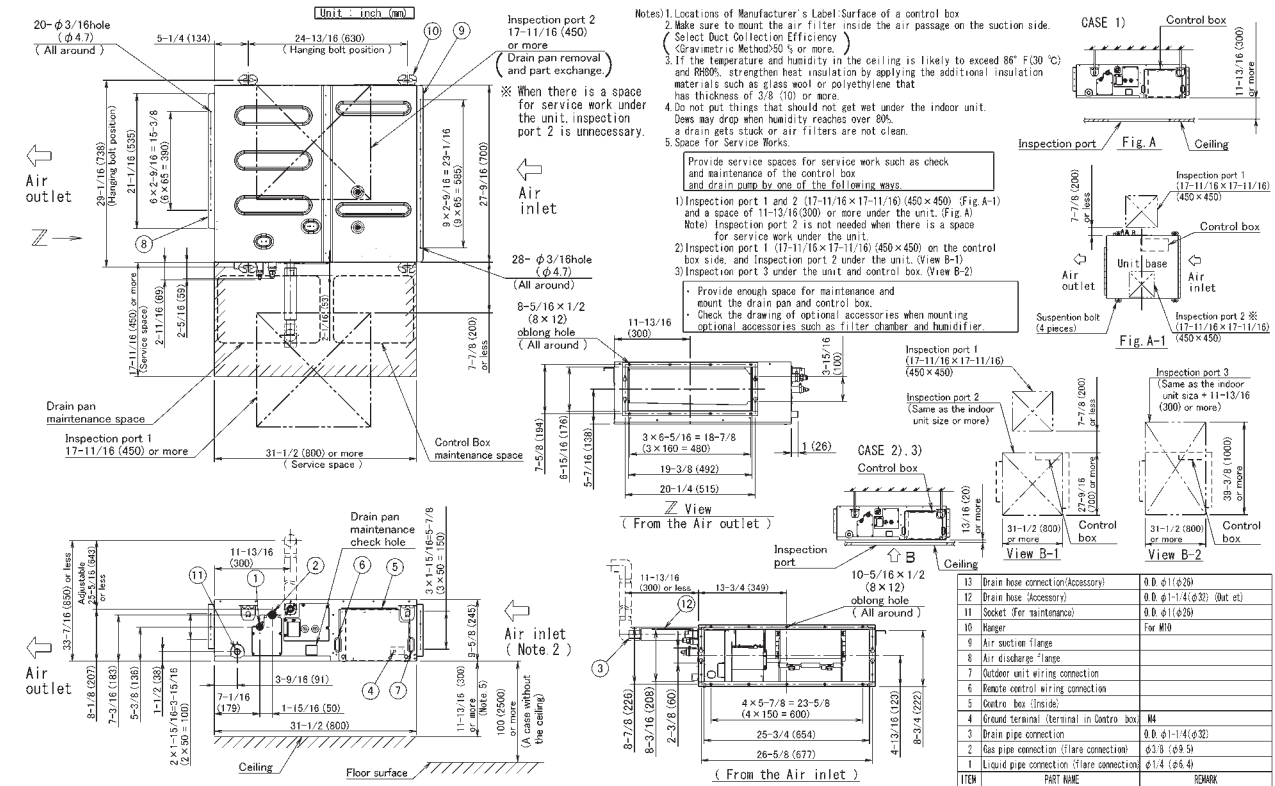

3D112918C

FDMQ18/24WVJU9

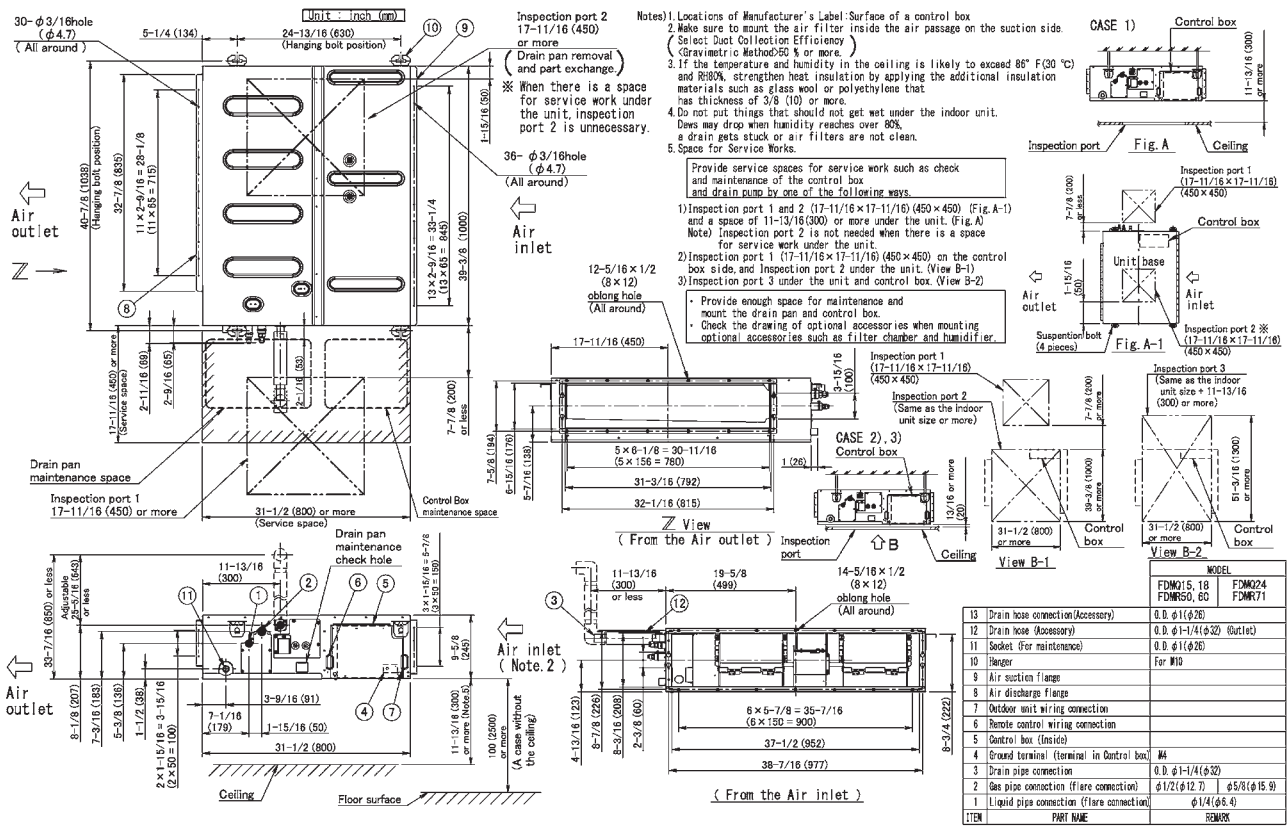

3D112919B



### BRC1E73 — Wired Remote Controller (Option) —

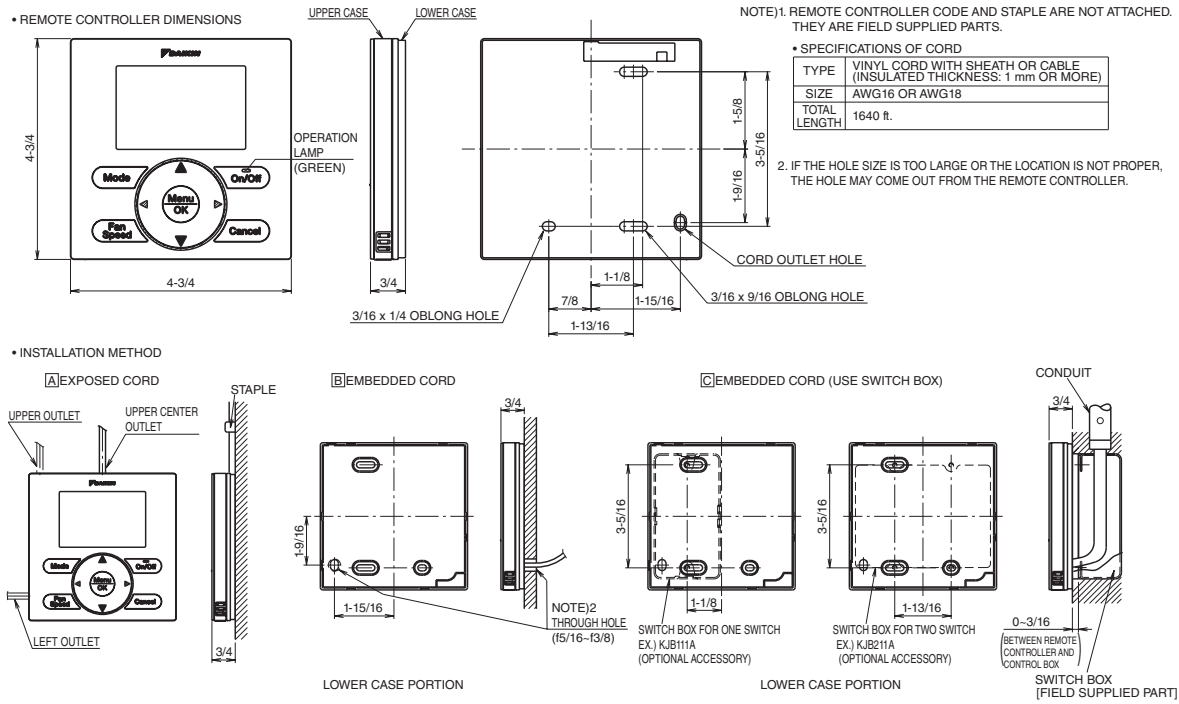

3D091305A

### BRC082A43 — Wireless Remote Controller (Option) —

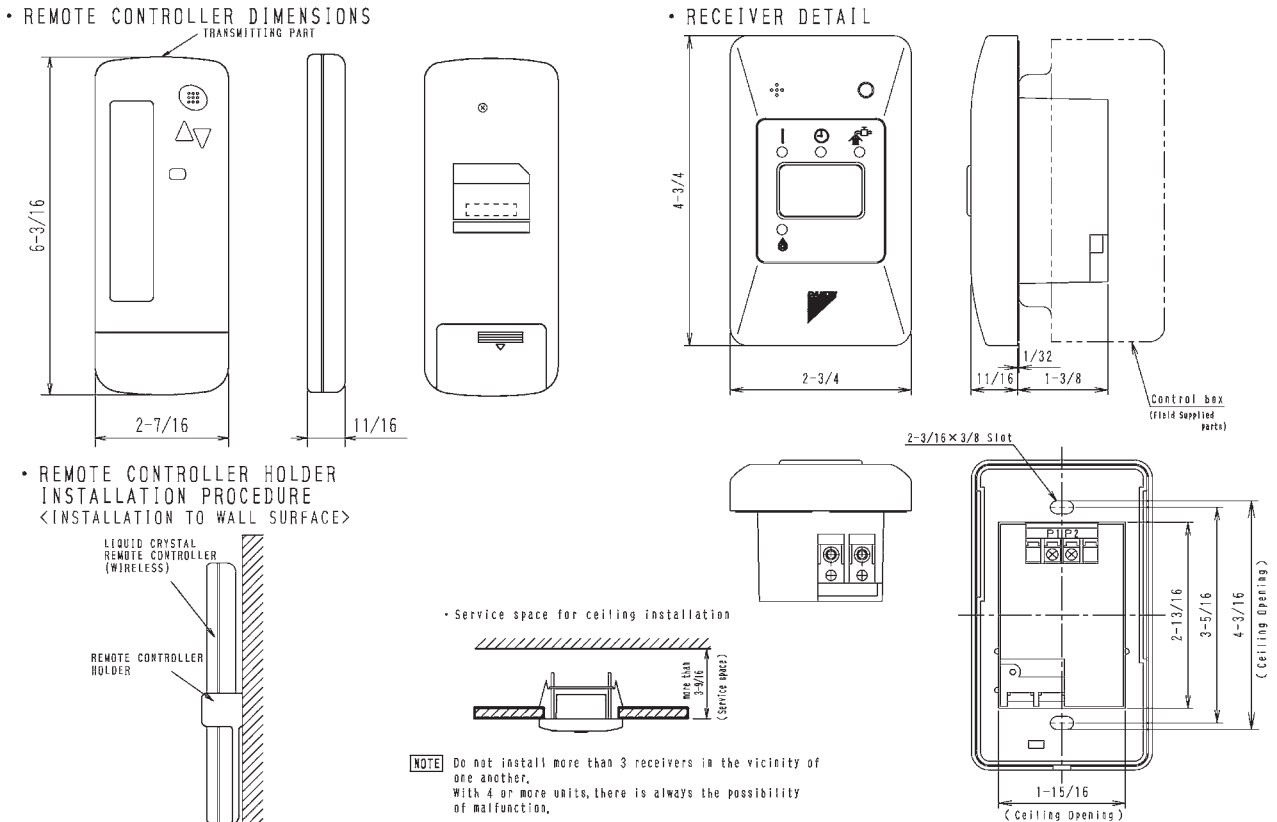

3D049611A

### 4.2 Outdoor Unit RXL09/12WMVJU9

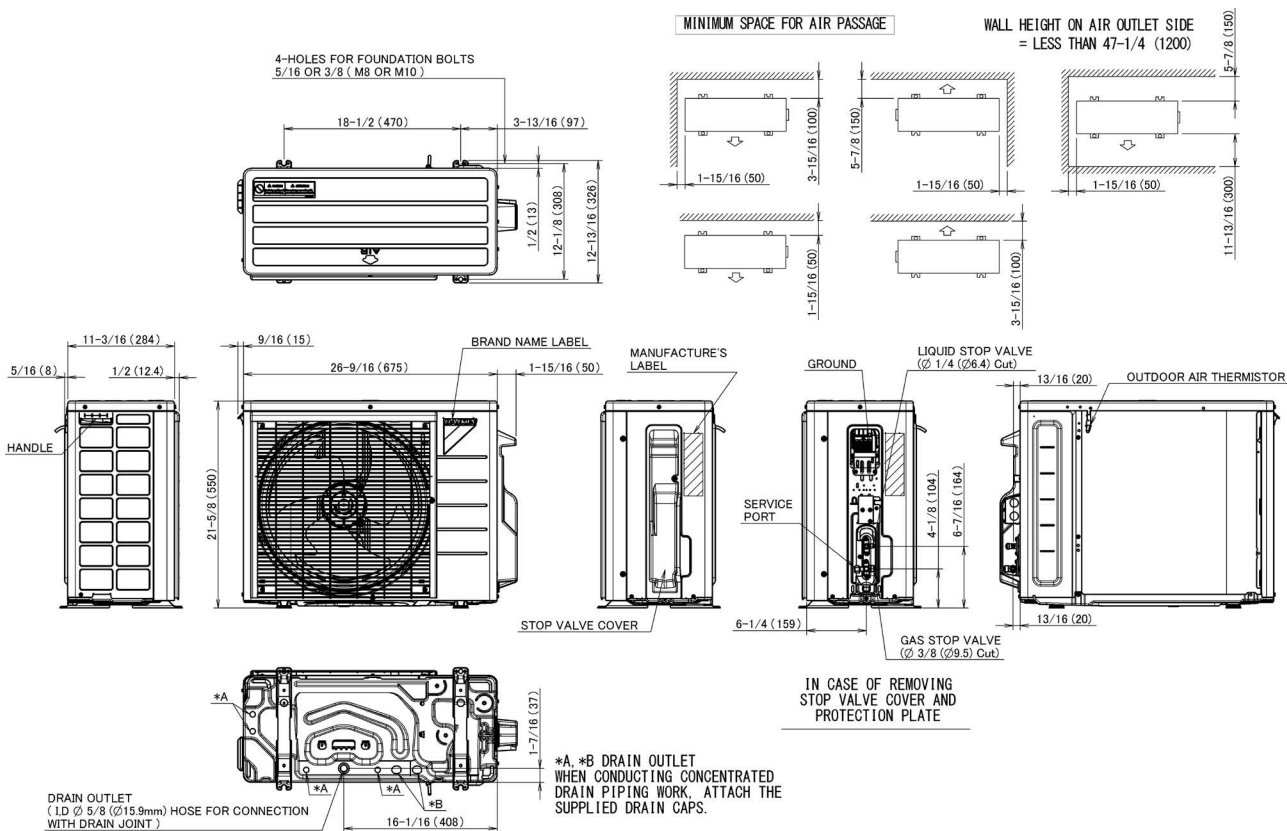

3D136777

### RXL15WMVJU9

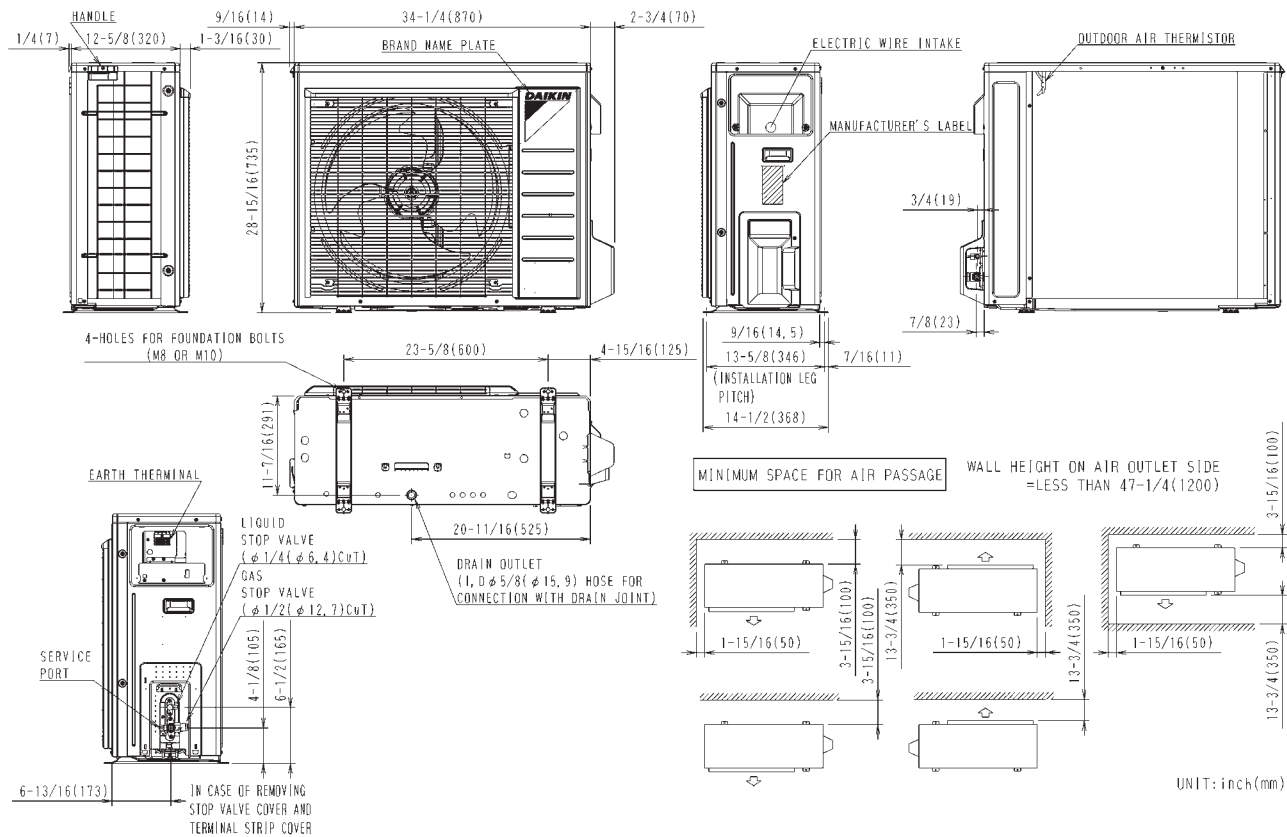

3D092224D

**RXL18WMVJU9**

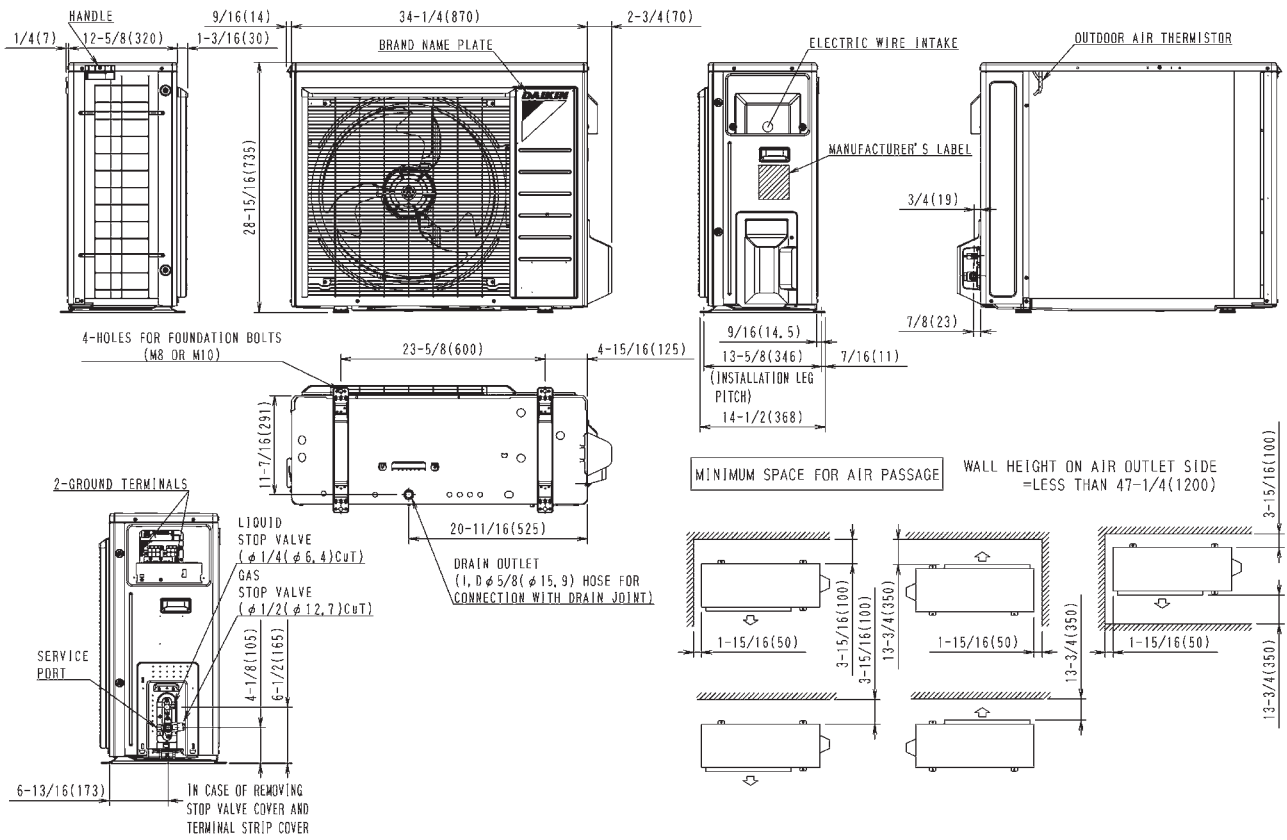

3D123362

**RXL24WMVJU9**

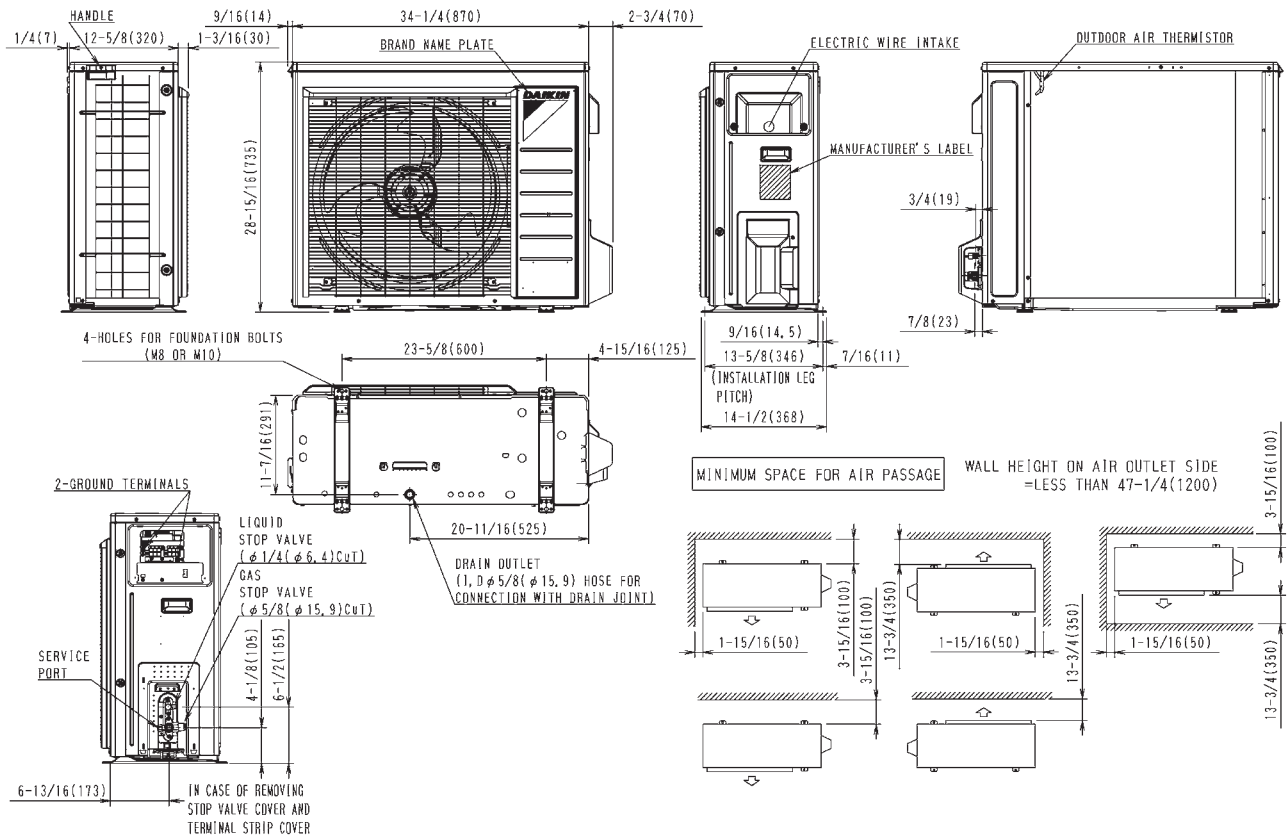

3D107983A

# 5. Wiring Diagrams

## 5.1 Indoor Unit FTX09/12WMVJU9

### WIRING DIAGRAM

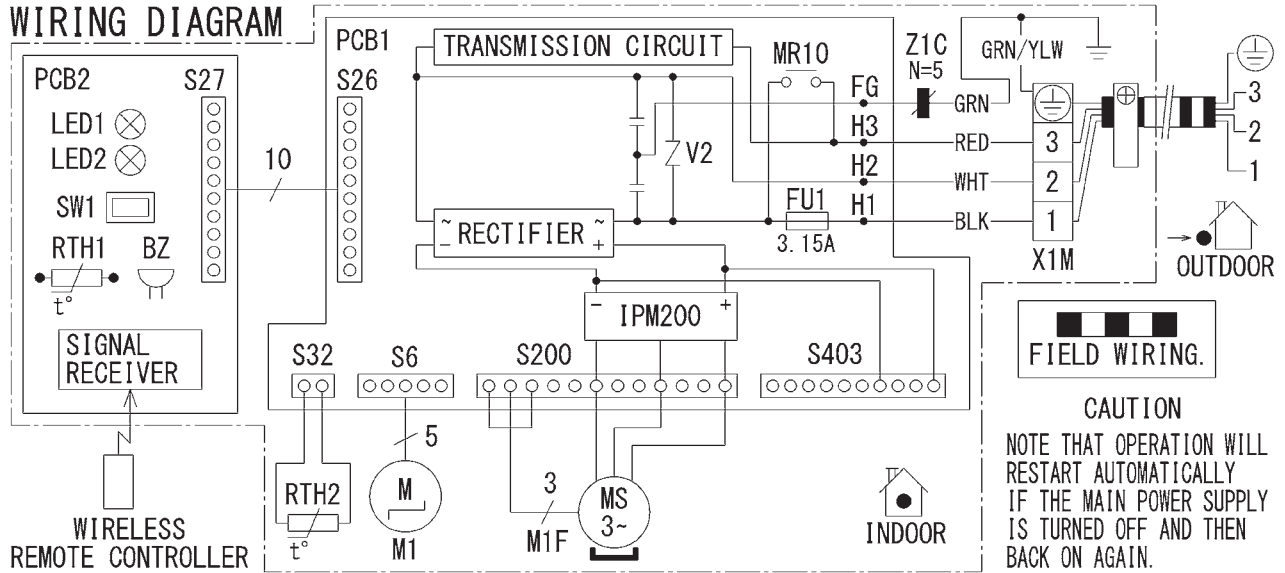

- |                  |                                 |                                  |                             |
|------------------|---------------------------------|----------------------------------|-----------------------------|
| BZ :BUZZER       | LED1, LED2:LIGHT-EMITTING DIODE | PCB1, PCB2:PRINTED CIRCUIT BOARD | V2 :VARISTOR                |
| FG :FRAME GROUND | M1F :FAN MOTOR                  | RTH1, RTH2:THERMISTOR            | X1M:TERMINAL STRIP          |
| FU1 :FUSE        | M1 :SWING MOTOR                 | S6~S403 :CONNECTOR               | Z1C:FERRITE CORE            |
| H1~H3:HARNESS    | MR10 :RELAY                     | SW1 :OPERATION SWITCH            | ⊕:PROTECTIVE EARTH (GROUND) |

**FIELD WIRING.**

**CAUTION**  
NOTE THAT OPERATION WILL RESTART AUTOMATICALLY IF THE MAIN POWER SUPPLY IS TURNED OFF AND THEN BACK ON AGAIN.

3D142895A

## FTX15WMVJU9

### WIRING DIAGRAM

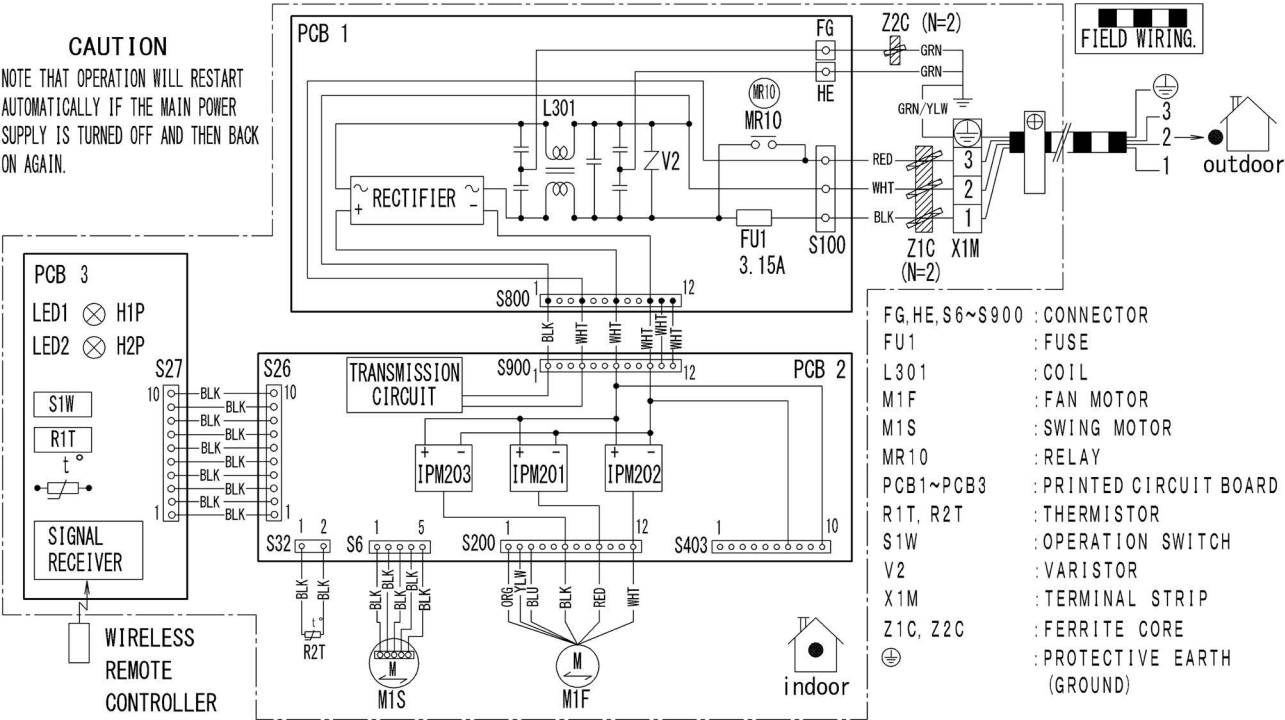

**CAUTION**  
NOTE THAT OPERATION WILL RESTART AUTOMATICALLY IF THE MAIN POWER SUPPLY IS TURNED OFF AND THEN BACK ON AGAIN.

- |                 |                            |
|-----------------|----------------------------|
| FG, HE, S6~S900 | :CONNECTOR                 |
| FU1             | :FUSE                      |
| L301            | :COIL                      |
| M1F             | :FAN MOTOR                 |
| M1S             | :SWING MOTOR               |
| MR10            | :RELAY                     |
| PCB1~PCB3       | :PRINTED CIRCUIT BOARD     |
| R1T, R2T        | :THERMISTOR                |
| S1W             | :OPERATION SWITCH          |
| V2              | :VARISTOR                  |
| X1M             | :TERMINAL STRIP            |
| Z1C, Z2C        | :FERRITE CORE              |
| ⊕               | :PROTECTIVE EARTH (GROUND) |

3D090199C

FTX18/24WVJU9

WIRING DIAGRAM

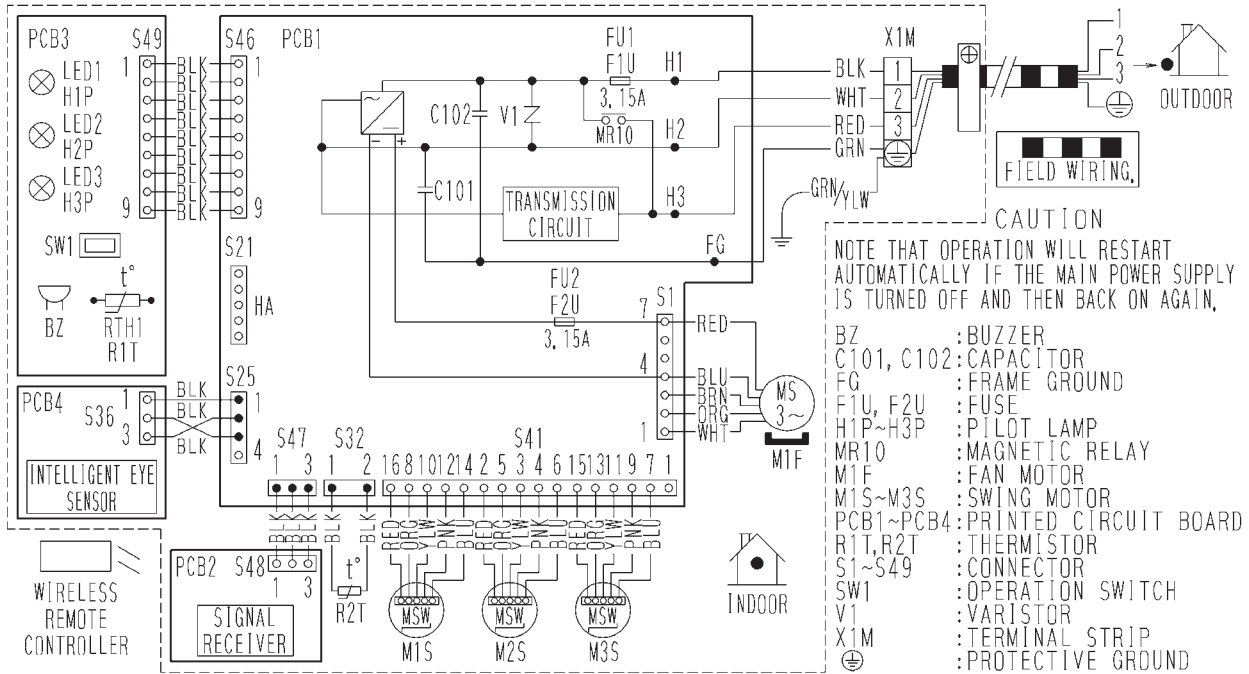

C: 3D060942X

FVXS09/12/15WVJU9

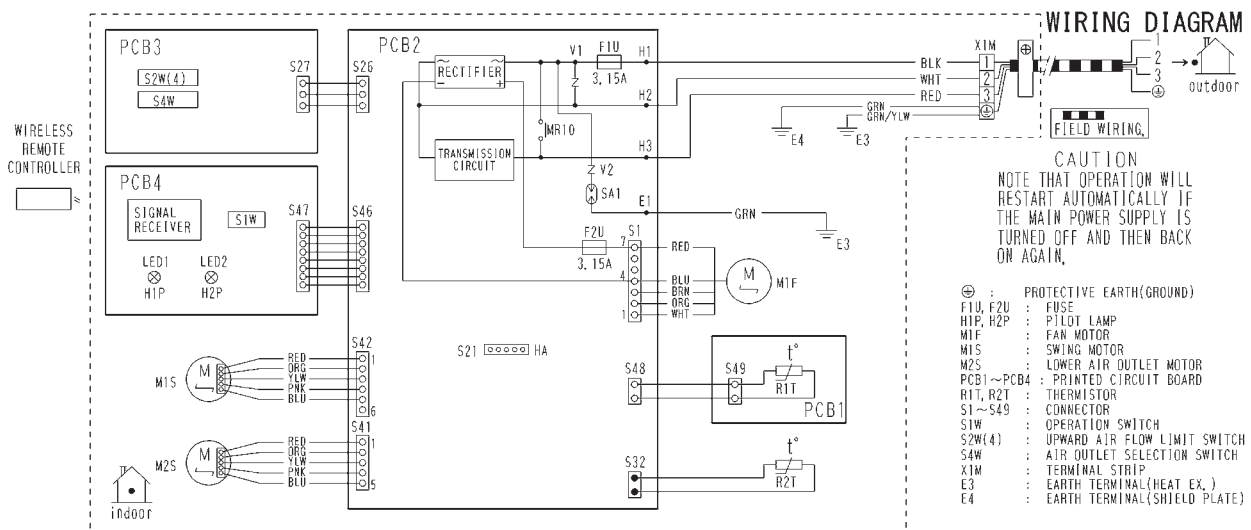

3D090604C

FDMQ12/18/24WVJU9

WIRING DIAGRAM

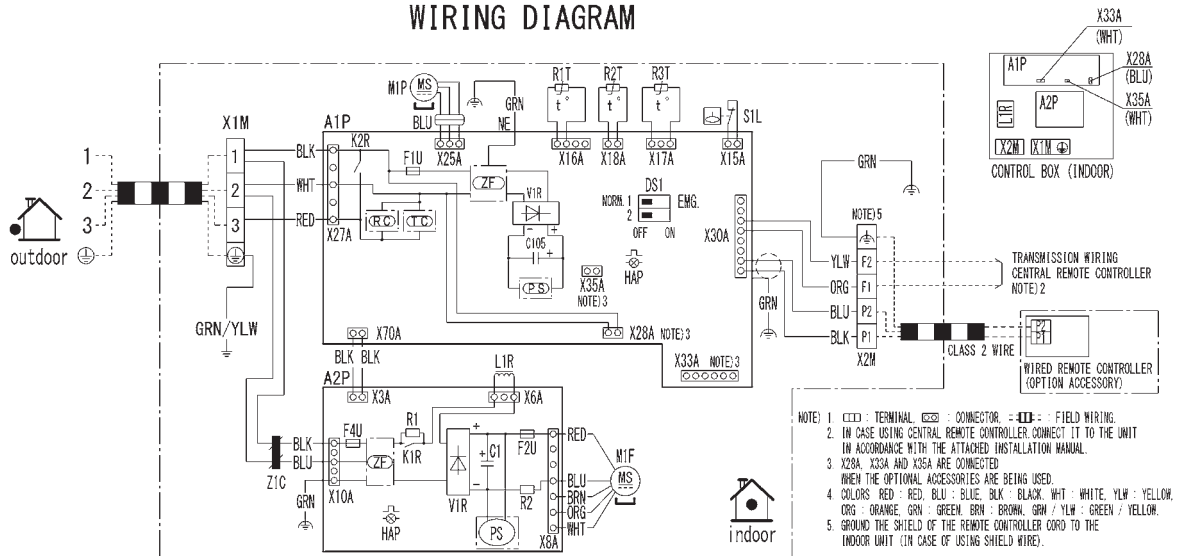

NOTE: 1. : TERMINAL : CONNECTOR : FIELD WIRING.  
 2. IN CASE USING CENTRAL REMOTE CONTROLLER, CONNECT IT TO THE UNIT IN ACCORDANCE WITH THE ATTACHED INSTALLATION MANUAL.  
 3. X28A, X33A AND X35A ARE CONNECTED WHEN THE OPTIONAL ACCESSORIES ARE BEING USED.  
 4. COLORS: RED : RED, BLU : BLUE, BLK : BLACK, WHT : WHITE, YLW : YELLOW, ORG : ORANGE, GRN : GREEN, BRN : BROWN, GRN/YLW : GREEN/YELLOW.  
 5. GROUND THE SHIELD OF THE REMOTE CONTROLLER CORD TO THE INDOOR UNIT (IN CASE OF USING SHIELD WIRE).

INDOOR UNIT		CONNECTOR	OPTIONAL ACCESSORY
A1P	PRINTED CIRCUIT BOARD	R1	RESISTOR (CURRENT LIMITING)
A2P	PRINTED CIRCUIT BOARD (FAN)	R2	CURRENT SENSING DEVICE
C1	CAPACITOR	R1T	THERMISTOR (SUCTION AIR)
C105	CAPACITOR	R1-101	THERMISTOR (HEAT EXCHANGER)
DS1	DIP SWITCH (EMERGENCY)	S1L	FLOAT SWITCH
F1J	FUSE (1. 3.15A, 250V)	V1R	DIODE BRIDGE
F2J	FUSE (1. 5A, 250V)	X1M	TERMINAL BLOCK (POWER SUPPLY)
F4J	FUSE	X2M	TERMINAL BLOCK (CONTROL)
-AP	PILOT LAMP SERVICE (INDOOR-SEER)	ZF	NOISE FILTER
K1R	MAGNETIC RELAY	Z1C	FERRITE CORE
K2R	MAGNETIC RELAY	PS	SWITCHING POWER SUPPLY
L1R	REACTOR	RC	RECEIVER
M1F	MOTOR (FAN INDOOR)	TC	TRANSMITTER
M1P	MOTOR (DRAIN PUMP)		

3D112629B



### 5.2 Outdoor Unit RXL09WMVJU9

#### WIRING DIAGRAM

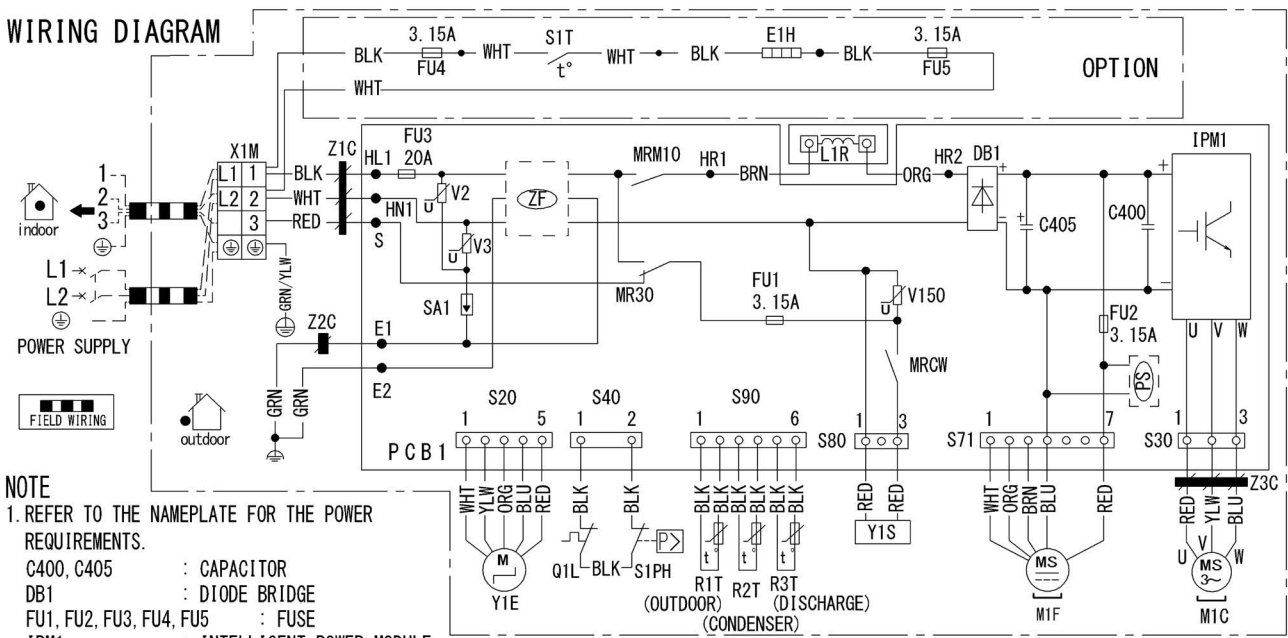

#### NOTE

1. REFER TO THE NAMEPLATE FOR THE POWER REQUIREMENTS.

- C400, C405 : CAPACITOR
- DB1 : DIODE BRIDGE
- FU1, FU2, FU3, FU4, FU5 : FUSE
- IPM1 : INTELLIGENT POWER MODULE
- L1, L2 : LIVE
- L1R : REACTOR
- M1C : COMPRESSOR MOTOR
- M1F : FAN MOTOR
- MR30, MRM10, MRCW : MAGNETIC RELAY
- PCB1 : PRINTED CIRCUIT BOARD
- PS : SWITCHING POWER SUPPLY

- Q1L : OVERLOAD PROTECTOR
- R1T, R2T, R3T : THERMISTOR
- S1PH : HIGH PRESSURE SWITCH
- S20, S30, S40, S71, S80, S90 : CONNECTOR
- SA1 : SURGE ARRESTER
- V2, V3, V150 : VARISTOR
- X1M : TERMINAL BLOCK
- Y1E : ELECTRONIC EXPANSION VALVE COIL
- Y1S : REVERSING SOLENOID VALVE COIL
- Z1C~Z3C : FERRITE CORE
- ZF : NOISE FILTER
- E1H : HEATER
- S1T : THERMOSTAT
- ⊕ : NOISELESS GROUND
- ⊕ : PROTECTIVE GROUND

C: 3D134975

### RXL12WMVJU9

#### WIRING DIAGRAM

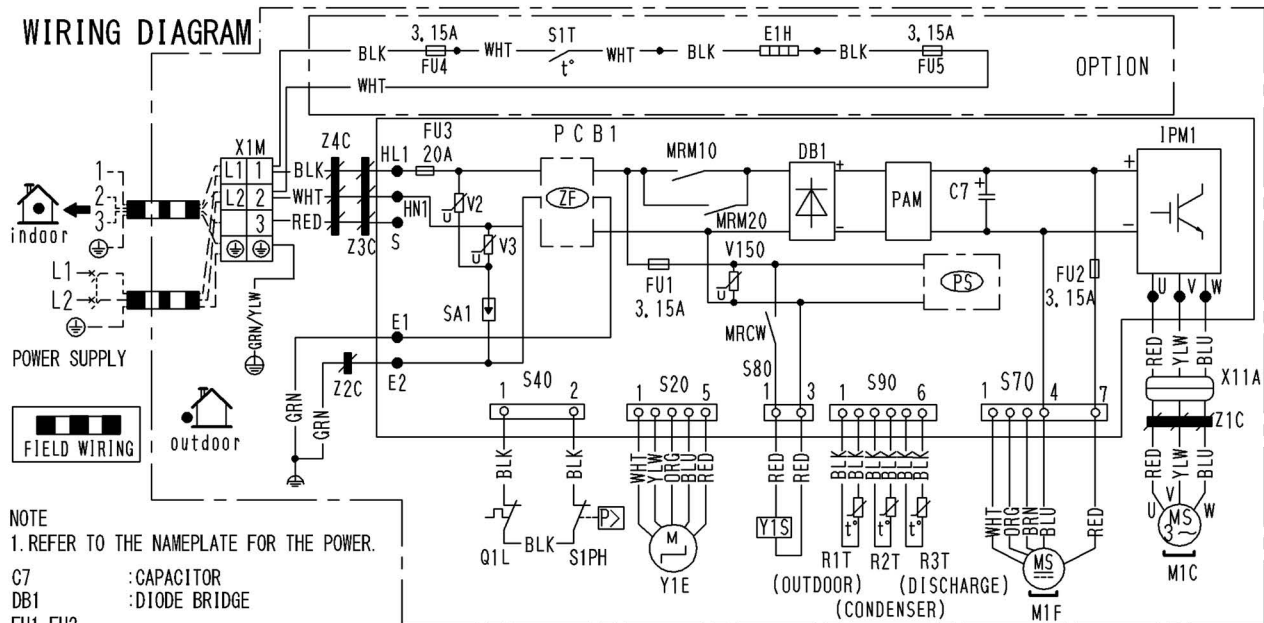

#### NOTE

1. REFER TO THE NAMEPLATE FOR THE POWER.

- C7 : CAPACITOR
- DB1 : DIODE BRIDGE
- FU1, FU2, FU3, FU4, FU5 : FUSE
- IPM1 : INTELLIGENT POWER MODULE
- L1, L2 : LIVE
- M1C : COMPRESSOR MOTOR
- M1F : FAN MOTOR
- MRM10, MRM20, MRCW : MAGNETIC RELAY
- PAM : PULSE AMPLITUDE MODULATION

- PCB1 : PRINTED CIRCUIT BOARD
- PS : SWITCHING POWER SUPPLY
- Q1L : OVERLOAD PROTECTOR
- R1T, R2T, R3T : THERMISTOR
- SA1 : SURGE ARRESTER
- S1PH : HIGH PRESSURE SWITCH
- S20, S40, S70, S80, S90, X11A : CONNECTOR
- V2, V3, V150 : VARISTOR
- X1M : TERMINAL BLOCK
- Y1E : ELECTRONIC EXPANSION VALVE COIL
- Y1S : REVERSING SOLENOID VALVE COIL
- Z1C~Z4C : FERRITE CORE
- ZF : NOISE FILTER
- E1H : HEATER
- S1T : THERMOSTAT
- ⊕ : NOISELESS GROUND
- ⊕ : PROTECTIVE GROUND

C: 3D134919





# 6. Piping Diagrams

## 6.1 Indoor Unit

### FTX09/12WMVJU9

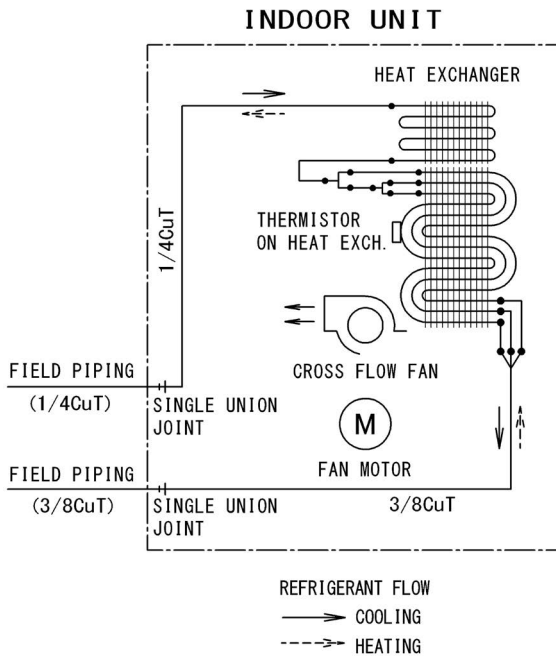

4D091708B

### FTX15WMVJU9

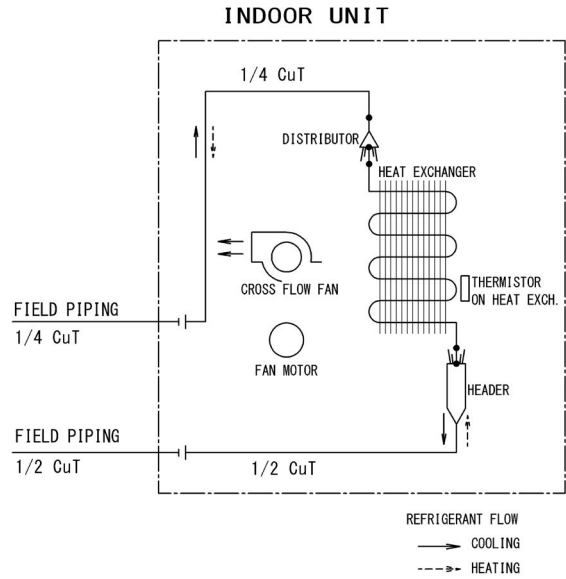

4D091769D

### FTX18WVJU9

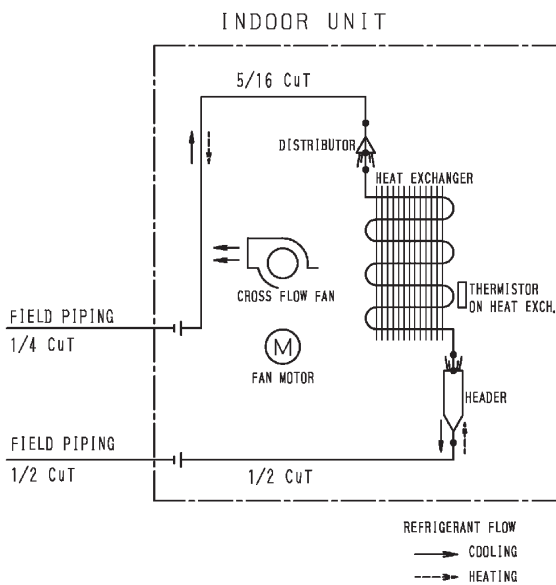

4D074609A

### FTX24WVJU9

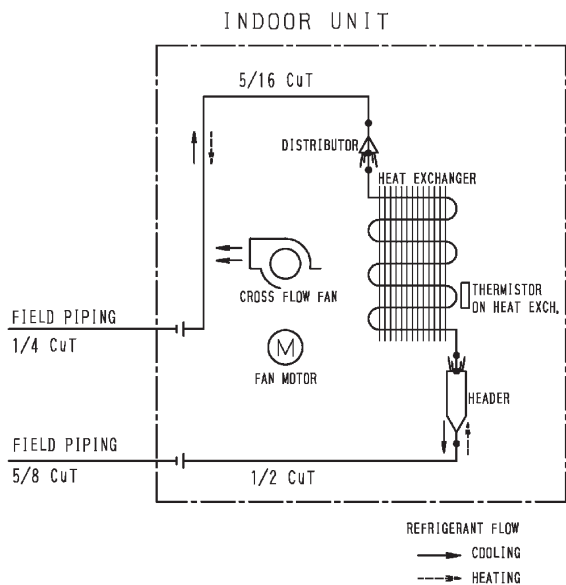

4D074608A

FVXS09/12WVJU9

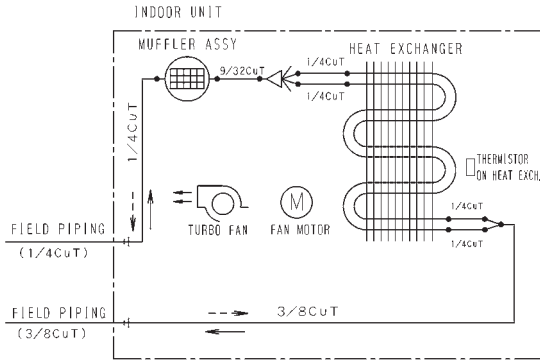

REFRIGERANT FLOW  
 —> COOLING  
 - - -> HEATING

FVXS15WVJU9

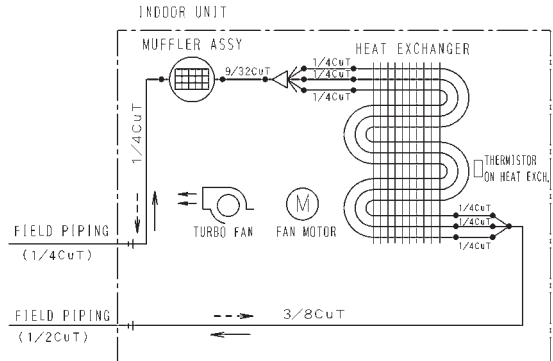

REFRIGERANT FLOW  
 —> COOLING  
 - - -> HEATING

4D091794A

4D091795B

FDMQ12/18/24WVJU9

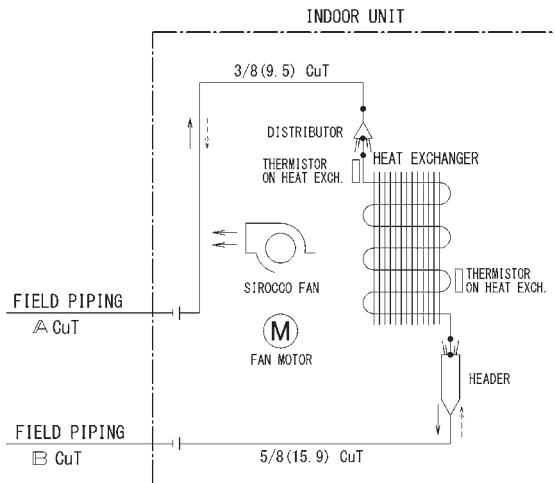

MODEL	A	B
FDM012	1/4 (6.4)	3/8 (9.5)
FDM018	1/4 (6.4)	1/2 (12.7)
FDM024	1/4 (6.4)	5/8 (15.9)

REFRIGERANT FLOW  
 —> COOLING  
 - - -> HEATING

C: 4D112974B

## 6.2 Outdoor Unit RXL09WMVJU9

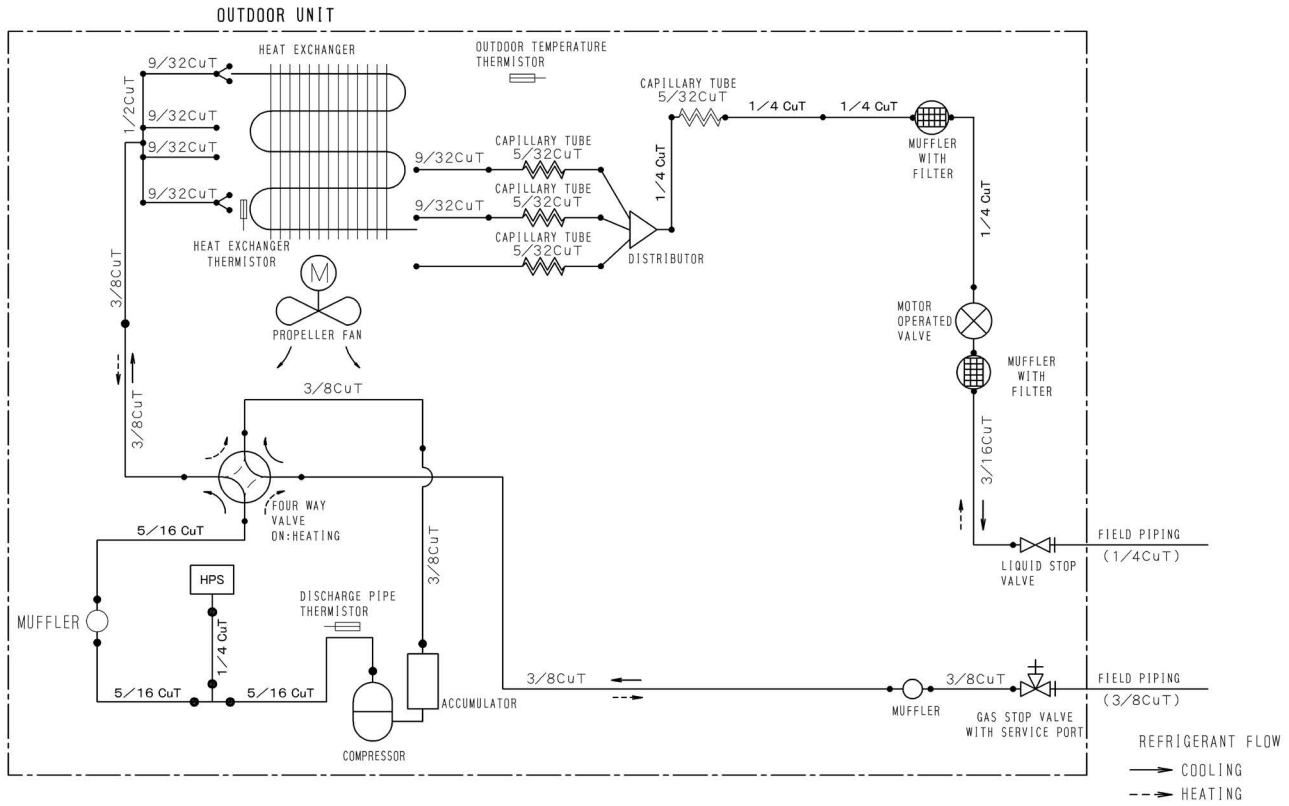

3D135015

## RXL12WMVJU9

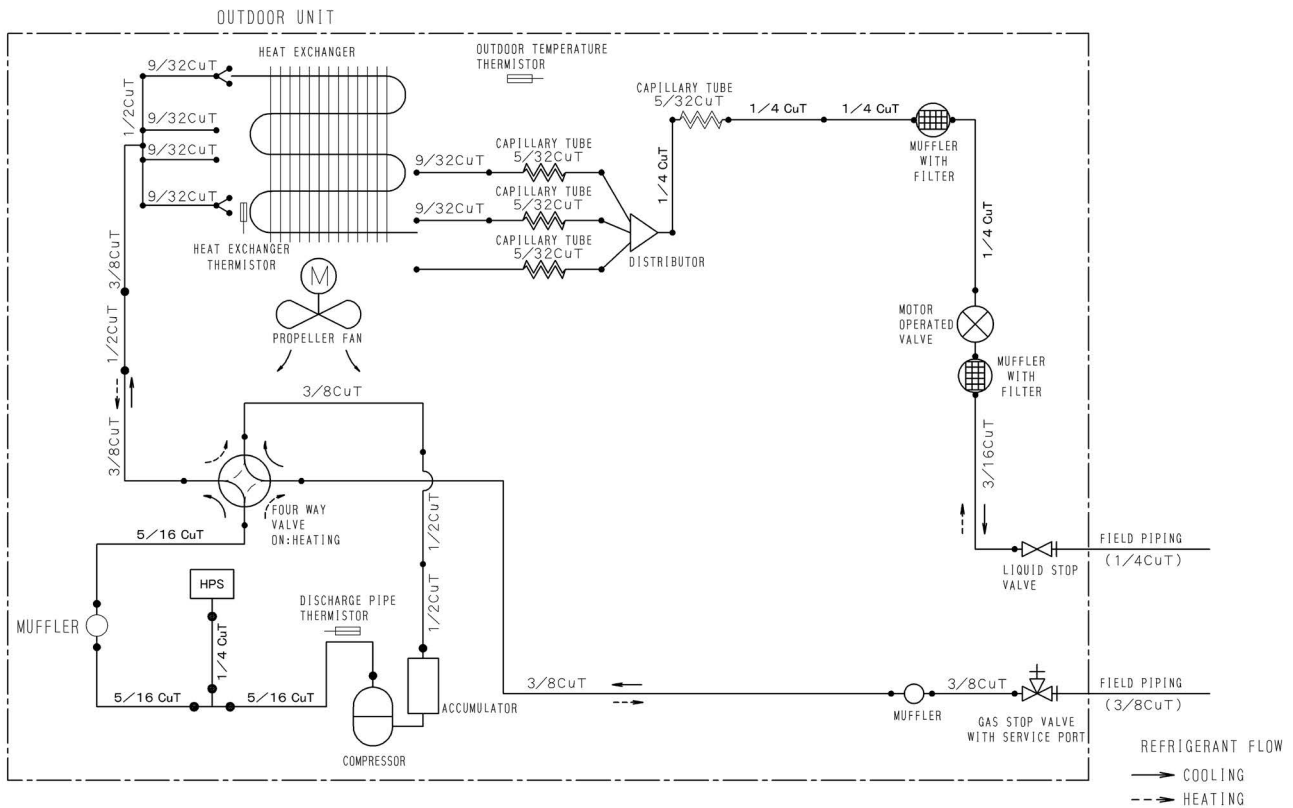

3D135016

**RXL15WMVJU9**

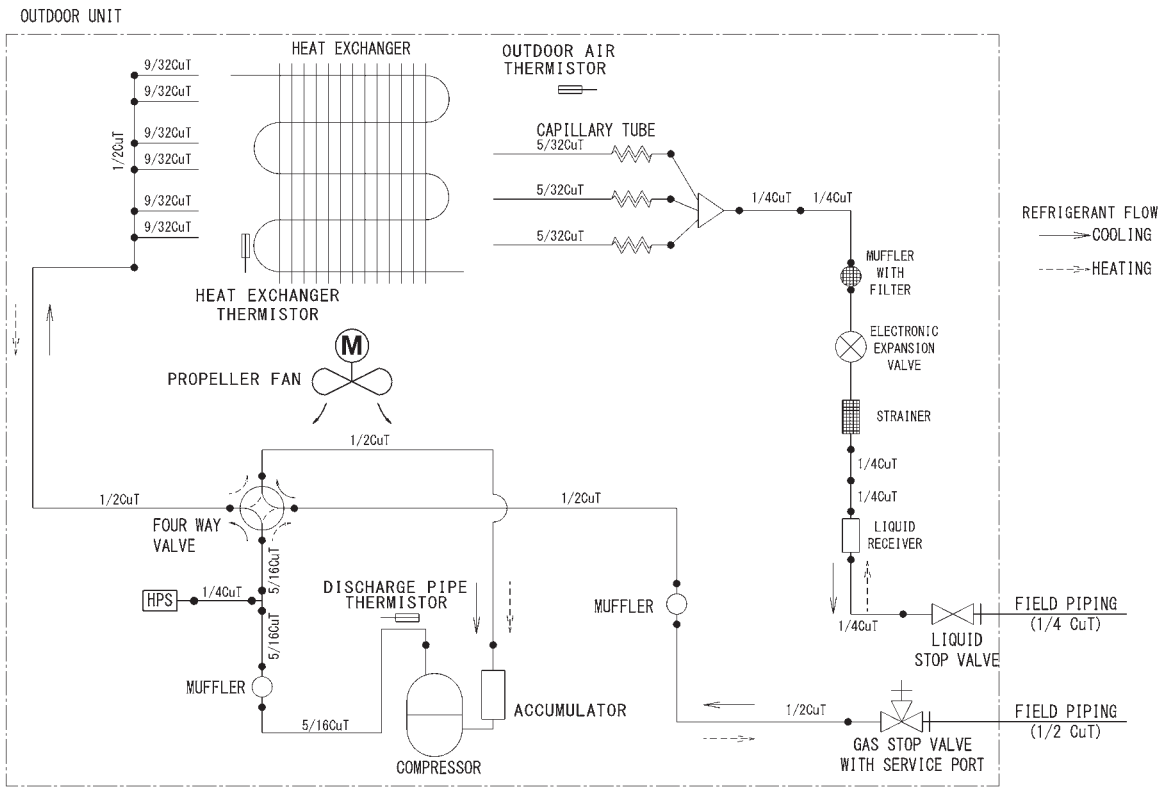

unit:inch

3D141505

**RXL18WMVJU9**

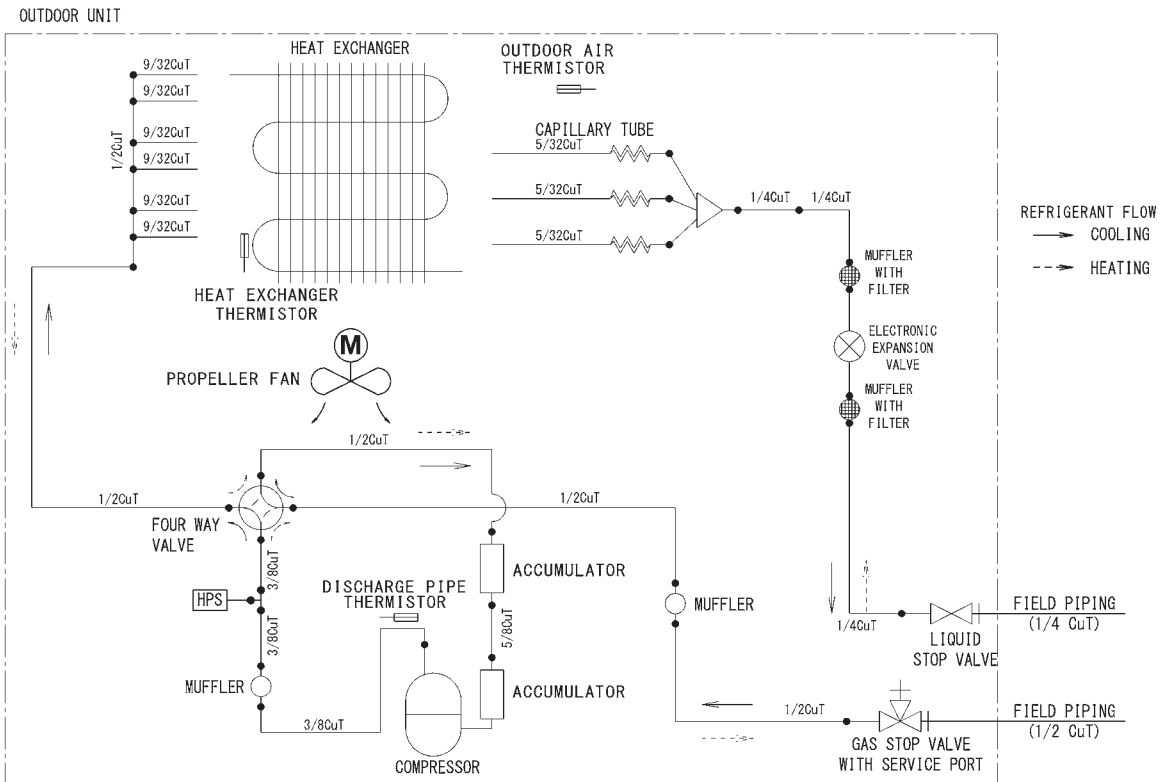

unit:inch

3D141506

RXL24WMVJU9

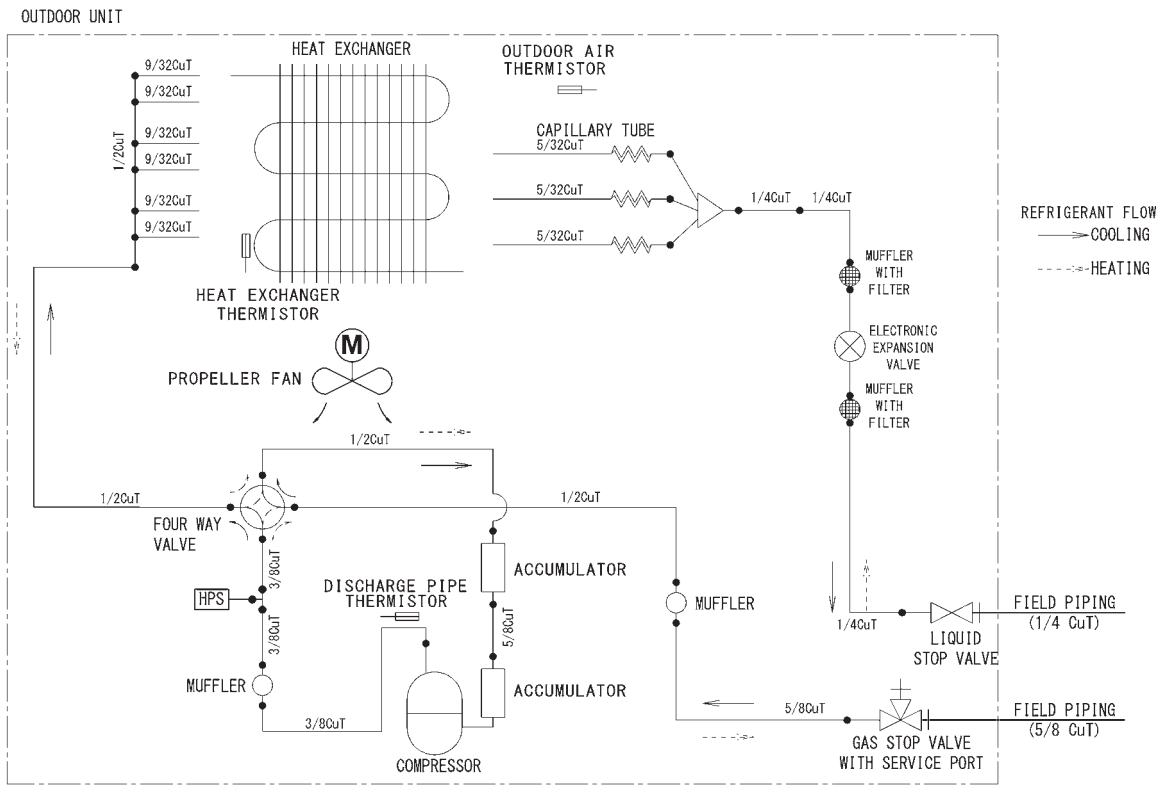

unit: inch

3D141503

# 7. Capacity Tables

## FTX09WMVJU9 + RXL09WMVJU9

### Cooling (60 Hz, 208 V)

AFR	11.8
BF	0.22

Temp: Celsius / TC, SHC, PI: kW

INDOOR		OUTDOOR TEMPERATURE (°CDB)																	
EWB	EDB	10			20			30			35			40			46		
°C	°C	TC	SHC	PI	TC	SHC	PI	TC	SHC	PI	TC	SHC	PI	TC	SHC	PI	TC	SHC	PI
14.0	20.0	2.95	2.38	0.48	2.70	2.27	0.60	2.46	2.15	0.72	2.34	2.10	0.77	2.21	2.04	0.83	2.07	1.97	0.90
16.0	22.0	3.07	2.34	0.49	2.83	2.23	0.60	2.58	2.12	0.72	2.46	2.07	0.78	2.33	2.02	0.83	2.19	1.96	0.90
18.0	25.0	3.19	2.47	0.49	2.95	2.37	0.61	2.70	2.27	0.72	2.58	2.22	0.78	2.46	2.18	0.84	2.31	2.12	0.91
19.4	26.7	3.25	2.63	0.49	3.01	2.54	0.61	2.76	2.44	0.72	2.64	2.39	0.78	2.52	2.35	0.84	2.37	2.29	0.91
22.0	30.0	3.44	2.54	0.50	3.19	2.46	0.61	2.95	2.37	0.73	2.82	2.33	0.79	2.70	2.29	0.84	2.55	2.24	0.91
24.0	32.0	3.56	2.48	0.62	3.31	2.41	0.62	3.07	2.33	0.73	2.94	2.29	0.79	2.82	2.25	0.85	2.67	2.21	0.92

Temp: Fahrenheit / TC, SHC: kBtu/h / PI: kW

INDOOR		OUTDOOR TEMPERATURE (°FDB)																	
EWB	EDB	50			68			86			95			104			115		
°F	°F	TC	SHC	PI	TC	SHC	PI	TC	SHC	PI	TC	SHC	PI	TC	SHC	PI	TC	SHC	PI
57.2	68.0	10.07	8.13	0.48	9.23	7.73	0.60	8.39	7.34	0.72	7.97	7.15	0.77	7.55	6.96	0.83	7.05	6.74	0.90
60.8	71.6	10.48	7.98	0.49	9.64	7.61	0.60	8.80	7.24	0.72	8.39	7.06	0.78	7.97	6.89	0.83	7.46	6.68	0.90
64.4	77.0	10.90	8.44	0.49	10.06	8.09	0.61	9.22	7.76	0.72	8.80	7.59	0.78	8.38	7.43	0.84	7.88	7.23	0.91
67.0	80.0	11.10	8.98	0.49	10.27	8.65	0.61	9.43	8.33	0.72	9.00	8.17	0.78	9.00	8.01	0.84	8.08	7.82	0.91
71.6	86.0	11.73	8.68	0.50	10.89	8.39	0.61	10.05	8.10	0.73	9.63	7.96	0.79	9.21	7.82	0.84	8.71	7.66	0.91
75.2	89.6	12.14	8.47	0.62	11.30	8.21	0.62	10.46	7.95	0.73	10.05	7.82	0.79	9.63	7.69	0.85	9.12	7.54	0.92

### Heating (60 Hz, 208 V)

AFR	11.4
-----	------

Temp: Celsius / TC, PI: kW

INDOOR		OUTDOOR TEMPERATURE (°CWB)															
EDB		-25		-20		-15		-10		-5		0		6		15.5	
°C		TC	PI	TC	PI	TC	PI	TC	PI	TC	PI	TC	PI	TC	PI	TC	PI
15.0		2.17	1.51	2.80	1.54	3.41	1.58	3.75	1.60	4.09	1.62	4.44	1.64	4.86	1.66	5.53	1.80
21.1		1.95	1.56	2.59	1.59	3.20	1.62	3.56	1.64	3.91	1.66	4.27	1.68	4.70	1.70	5.38	1.83
22.0		1.86	1.58	2.47	1.58	2.95	1.50	3.42	1.61	3.84	1.68	4.20	1.69	4.64	1.72	5.32	1.85
24.0		1.62	1.39	2.09	1.30	2.57	1.28	3.04	1.40	3.77	1.69	4.13	1.71	4.57	1.73	5.26	1.86
25.0		1.43	1.20	1.90	1.16	2.38	1.17	2.85	1.30	3.73	1.70	4.10	1.72	4.54	1.74	5.23	1.87
27.0		1.05	0.85	1.52	0.91	2.00	0.96	2.47	1.10	3.42	1.54	4.03	1.73	4.47	1.75	5.16	1.89

Temp: Fahrenheit / TC: kBtu/h / PI: kW

INDOOR		OUTDOOR TEMPERATURE (°FWB)															
EDB		-13		-4		5		14		23		32		43		60	
°F		TC	PI	TC	PI	TC	PI	TC	PI	TC	PI	TC	PI	TC	PI	TC	PI
59.0		7.40	1.51	9.55	1.54	11.62	1.58	12.77	1.60	13.94	1.62	15.12	1.64	16.55	1.66	18.83	1.80
70.0		6.63	1.56	8.81	1.59	10.90	1.62	12.11	1.64	13.33	1.66	14.54	1.68	16.00	1.70	18.31	1.83
71.6		6.33	1.58	8.43	1.58	10.05	1.50	11.68	1.61	13.08	1.68	14.31	1.69	15.78	1.72	18.10	1.85
75.2		5.51	1.39	7.14	1.30	8.76	1.28	10.38	1.40	12.84	1.69	14.08	1.71	15.56	1.73	17.89	1.86
77.0		4.87	1.20	6.49	1.16	8.11	1.17	9.73	1.30	12.72	1.70	13.96	1.72	15.45	1.74	17.79	1.87
80.6		3.57	0.85	5.19	0.91	6.81	0.96	8.43	1.10	11.68	1.54	13.73	1.73	15.23	1.75	17.58	1.89

**Cooling (60 Hz, 230 V)**

AFR	11.8
BF	0.22

Temp: Celsius / TC, SHC, PI: kW

INDOOR		OUTDOOR TEMPERATURE (°CDB)																	
EWB	EDB	10			20			30			35			40			46		
°C	°C	TC	SHC	PI	TC	SHC	PI	TC	SHC	PI	TC	SHC	PI	TC	SHC	PI	TC	SHC	PI
14.0	20.0	2.95	2.38	0.48	2.70	2.27	0.60	2.46	2.15	0.72	2.34	2.10	0.77	2.21	2.04	0.83	2.07	1.97	0.90
16.0	22.0	3.07	2.34	0.49	2.83	2.23	0.60	2.58	2.12	0.72	2.46	2.07	0.78	2.33	2.02	0.83	2.19	1.96	0.90
18.0	25.0	3.19	2.47	0.49	2.95	2.37	0.61	2.70	2.27	0.72	2.58	2.22	0.78	2.46	2.18	0.84	2.31	2.12	0.91
19.4	26.7	3.25	2.63	0.49	3.01	2.54	0.61	2.76	2.44	0.72	2.64	2.39	0.78	2.52	2.35	0.84	2.37	2.29	0.91
22.0	30.0	3.44	2.54	0.50	3.19	2.46	0.61	2.95	2.37	0.73	2.82	2.33	0.79	2.70	2.29	0.84	2.55	2.24	0.91
24.0	32.0	3.56	2.48	0.62	3.31	2.41	0.62	3.07	2.33	0.73	2.94	2.29	0.79	2.82	2.25	0.85	2.67	2.21	0.92

Temp: Fahrenheit / TC, SHC: kBtu/h / PI: kW

INDOOR		OUTDOOR TEMPERATURE (°FDB)																	
EWB	EDB	50			68			86			95			104			115		
°F	°F	TC	SHC	PI	TC	SHC	PI	TC	SHC	PI	TC	SHC	PI	TC	SHC	PI	TC	SHC	PI
57.2	68.0	10.07	8.13	0.48	9.23	7.73	0.60	8.39	7.34	0.72	7.97	7.15	0.77	7.55	6.96	0.83	7.05	6.74	0.90
60.8	71.6	10.48	7.98	0.49	9.64	7.61	0.60	8.80	7.24	0.72	8.39	7.06	0.78	7.97	6.89	0.83	7.46	6.68	0.90
64.4	77.0	10.90	8.44	0.49	10.06	8.09	0.61	9.22	7.76	0.72	8.80	7.59	0.78	8.38	7.43	0.84	7.88	7.23	0.91
67.0	80.0	11.10	8.98	0.49	10.27	8.65	0.61	9.43	8.33	0.72	9.00	8.17	0.78	9.00	8.01	0.84	8.08	7.82	0.91
71.6	86.0	11.73	8.68	0.50	10.89	8.39	0.61	10.05	8.10	0.73	9.63	7.96	0.79	9.21	7.82	0.84	8.71	7.66	0.91
75.2	89.6	12.14	8.47	0.62	11.30	8.21	0.62	10.46	7.95	0.73	10.05	7.82	0.79	9.63	7.69	0.85	9.12	7.54	0.92

**Heating (60 Hz, 230 V)**

AFR	11.4
-----	------

Temp: Celsius / TC, PI: kW

INDOOR		OUTDOOR TEMPERATURE (°CWB)																	
EDB		-25		-20		-15		-10		-5		0		6		15.5			
°C		TC	PI	TC	PI	TC	PI	TC	PI	TC	PI	TC	PI	TC	PI	TC	PI		
15.0		2.17	1.51	2.80	1.54	3.41	1.58	3.75	1.60	4.09	1.62	4.44	1.64	4.86	1.66	5.53	1.80		
21.1		1.95	1.56	2.59	1.59	3.20	1.62	3.56	1.64	3.91	1.66	4.27	1.68	4.70	1.70	5.38	1.83		
22.0		1.86	1.58	2.47	1.58	2.95	1.50	3.42	1.61	3.84	1.68	4.20	1.69	4.64	1.72	5.32	1.85		
24.0		1.62	1.39	2.09	1.30	2.57	1.28	3.04	1.40	3.77	1.69	4.13	1.71	4.57	1.73	5.26	1.86		
25.0		1.43	1.20	1.90	1.16	2.38	1.17	2.85	1.30	3.73	1.70	4.10	1.72	4.54	1.74	5.23	1.87		
27.0		1.05	0.85	1.52	0.91	2.00	0.96	2.47	1.10	3.42	1.54	4.03	1.73	4.47	1.75	5.16	1.89		

Temp: Fahrenheit / TC: kBtu/h / PI: kW

INDOOR		OUTDOOR TEMPERATURE (°FWB)																	
EDB		-13		-4		5		14		23		32		43		60			
°F		TC	PI	TC	PI	TC	PI	TC	PI	TC	PI	TC	PI	TC	PI	TC	PI		
59.0		7.40	1.51	9.55	1.54	11.62	1.58	12.77	1.60	13.94	1.62	15.12	1.64	16.55	1.66	18.83	1.80		
70.0		6.63	1.56	8.81	1.59	10.90	1.62	12.11	1.64	13.33	1.66	14.54	1.68	16.00	1.70	18.31	1.83		
71.6		6.33	1.58	8.43	1.58	10.05	1.50	11.68	1.61	13.08	1.68	14.31	1.69	15.78	1.72	18.10	1.85		
75.2		5.51	1.39	7.14	1.30	8.76	1.28	10.38	1.40	12.84	1.69	14.08	1.71	15.56	1.73	17.89	1.86		
77.0		4.87	1.20	6.49	1.16	8.11	1.17	9.73	1.30	12.72	1.70	13.96	1.72	15.45	1.74	17.79	1.87		
80.6		3.57	0.85	5.19	0.91	6.81	0.96	8.43	1.10	11.68	1.54	13.73	1.73	15.23	1.75	17.58	1.89		

**Symbols:**

- AFR : Airflow rate (m³/min.)
- BF : Bypass factor
- EWB : Entering wet bulb temp. (°C) / (°F)
- EDB : Entering dry bulb temp. (°C) / (°F)
- TC : Total capacity (kW) / (kBtu/h)
- SHC : Sensible heat capacity (kW) / (kBtu/h)
- PI : Power input (kW)

**Notes:**

1.  shows nominal (rated) capacities and power input (Cooling) and MAX capacities and power input (Heating).
2. TC, PI and SHC must be calculated by interpolation using the figures in the above tables. (Figures out of the tables should not be used for calculation.)
3. Capacities are based on the following conditions.  
Corresponding refrigerant piping length : 25 ft (7.5 m)  
Level difference : 0 ft (0 m)
4. Airflow rate (AFR) and Bypass factor (BF) are tabulated above table.

### FTX12WMVJU9 + RXL12WMVJU9

**Cooling (60 Hz, 208 V)**

AFR	12.3
BF	0.22

Temp: Celsius / TC, SHC, PI: kW

INDOOR		OUTDOOR TEMPERATURE (°CDB)																	
EWB	EDB	10			20			30			35			40			46		
°C	°C	TC	SHC	PI	TC	SHC	PI	TC	SHC	PI	TC	SHC	PI	TC	SHC	PI	TC	SHC	PI
14.0	20.0	3.48	2.68	0.57	3.19	2.54	0.71	2.90	2.40	0.84	2.75	2.33	0.91	2.61	2.26	0.98	2.43	2.18	1.06
16.0	22.0	3.62	2.62	0.57	3.33	2.49	0.71	3.04	2.36	0.85	2.90	2.30	0.91	2.75	2.24	0.98	2.58	2.16	1.06
18.0	25.0	3.76	2.76	0.58	3.47	2.64	0.71	3.18	2.52	0.85	3.04	2.46	0.92	2.89	2.40	0.99	2.72	2.33	1.07
19.4	26.7	3.83	2.92	0.58	3.54	2.80	0.72	3.25	2.69	0.85	3.11	2.63	0.92	2.97	2.58	0.99	2.79	2.51	1.07
22.0	30.0	4.05	2.82	0.59	3.76	2.71	0.72	3.47	2.61	0.86	3.32	2.56	0.93	3.18	2.51	1.00	3.01	2.45	1.08
24.0	32.0	4.19	2.74	0.73	3.90	2.65	0.73	3.61	2.56	0.86	3.47	2.51	0.93	3.32	2.47	1.00	3.15	2.41	1.08

Temp: Fahrenheit / TC, SHC: kBtu/h / PI: kW

INDOOR		OUTDOOR TEMPERATURE (°FDB)																	
EWB	EDB	50			68			86			95			104			115		
°F	°F	TC	SHC	PI	TC	SHC	PI	TC	SHC	PI	TC	SHC	PI	TC	SHC	PI	TC	SHC	PI
57.2	68.0	11.86	9.13	0.57	10.87	8.65	0.71	9.88	8.19	0.84	9.39	7.95	0.91	8.90	7.73	0.98	8.30	7.45	1.06
60.8	71.6	12.35	8.96	0.57	11.36	8.51	0.71	10.37	8.07	0.85	9.88	7.85	0.91	9.38	7.64	0.98	8.79	7.38	1.06
64.4	77.0	12.84	9.42	0.58	11.85	9.00	0.71	10.86	8.59	0.85	10.37	8.39	0.92	9.87	8.19	0.99	9.28	7.95	1.07
67.0	80.0	13.08	9.97	0.58	12.09	9.57	0.72	11.11	9.18	0.85	10.60	8.98	0.92	10.12	8.79	0.99	9.52	8.56	1.07
71.6	86.0	13.82	9.61	0.59	12.83	9.26	0.72	11.84	8.91	0.86	11.34	8.74	0.93	10.85	8.57	1.00	10.26	8.37	1.08
75.2	89.6	14.30	9.36	0.73	13.32	9.04	0.73	12.33	8.73	0.86	11.83	8.57	0.93	11.34	8.42	1.00	10.75	8.23	1.08

**Heating (60 Hz, 208 V)**

AFR	11.7
-----	------

Temp: Celsius / TC, PI: kW

INDOOR		OUTDOOR TEMPERATURE (°CWB)																	
EDB		-25		-20		-15		-10		-5		0		6		15.5			
°C		TC	PI	TC	PI	TC	PI	TC	PI	TC	PI	TC	PI	TC	PI	TC	PI		
15.0		2.85	1.73	3.68	1.77	4.48	1.81	4.75	1.74	5.04	1.68	5.33	1.61	5.69	1.53	6.87	1.65		
21.1		2.56	1.79	3.40	1.82	4.20	1.86	4.51	1.79	4.82	1.72	5.13	1.65	5.50	1.56	6.68	1.68		
22.0		2.31	1.65	3.20	1.77	4.09	1.88	4.41	1.81	4.73	1.74	5.05	1.66	5.42	1.58	6.44	1.63		
24.0		1.92	1.35	2.81	1.53	3.71	1.69	4.31	1.83	4.64	1.75	4.96	1.68	5.35	1.59	6.05	1.51		
25.0		1.72	1.20	2.62	1.41	3.51	1.59	4.27	1.84	4.60	1.76	4.92	1.69	5.31	1.60	5.85	1.46		
27.0		1.33	0.91	2.23	1.18	3.12	1.39	3.90	1.66	4.51	1.78	4.84	1.70	5.23	1.61	5.46	1.34		

Temp: Fahrenheit / TC: kBtu/h / PI: kW

INDOOR		OUTDOOR TEMPERATURE (°FWB)																	
EDB		-13		-4		5		14		23		32		43		60			
°F		TC	PI	TC	PI	TC	PI	TC	PI	TC	PI	TC	PI	TC	PI	TC	PI		
59.0		9.73	1.73	12.55	1.77	15.27	1.81	16.23	1.74	17.21	1.68	18.22	1.61	19.45	1.53	23.48	1.65		
70.0		8.72	1.79	11.58	1.82	14.33	1.86	15.39	1.79	16.46	1.72	17.52	1.65	18.80	1.56	22.83	1.68		
71.6		7.88	1.65	10.93	1.77	13.95	1.88	15.06	1.81	16.16	1.74	17.24	1.66	18.54	1.58	21.97	1.63		
75.2		6.55	1.35	9.60	1.53	12.65	1.69	14.73	1.83	15.85	1.75	16.96	1.68	18.28	1.59	20.64	1.51		
77.0		5.88	1.20	8.93	1.41	11.98	1.59	14.56	1.84	15.70	1.76	16.82	1.69	18.15	1.60	19.97	1.46		
80.6		4.55	0.91	7.60	1.18	10.65	1.39	13.32	1.66	15.40	1.78	16.54	1.70	17.89	1.61	18.64	1.34		



**Cooling (60 Hz, 230 V)**

AFR	12.3
BF	0.22

Temp: Celsius / TC, SHC, PI: kW

INDOOR		OUTDOOR TEMPERATURE (°CDB)																	
EWB	EDB	10			20			30			35			40			46		
°C	°C	TC	SHC	PI	TC	SHC	PI	TC	SHC	PI	TC	SHC	PI	TC	SHC	PI	TC	SHC	PI
14.0	20.0	3.48	2.68	0.57	3.19	2.54	0.71	2.90	2.40	0.84	2.75	2.33	0.91	2.61	2.26	0.98	2.43	2.18	1.06
16.0	22.0	3.62	2.62	0.57	3.33	2.49	0.71	3.04	2.36	0.85	2.90	2.30	0.91	2.75	2.24	0.98	2.58	2.16	1.06
18.0	25.0	3.76	2.76	0.58	3.47	2.64	0.71	3.18	2.52	0.85	3.04	2.46	0.92	2.89	2.40	0.99	2.72	2.33	1.07
19.4	26.7	3.83	2.92	0.58	3.54	2.80	0.72	3.25	2.69	0.85	3.11	2.63	0.92	2.97	2.58	0.99	2.79	2.51	1.07
22.0	30.0	4.05	2.82	0.59	3.76	2.71	0.72	3.47	2.61	0.86	3.32	2.56	0.93	3.18	2.51	1.00	3.01	2.45	1.08
24.0	32.0	4.19	2.74	0.73	3.90	2.65	0.73	3.61	2.56	0.86	3.47	2.51	0.93	3.32	2.47	1.00	3.15	2.41	1.08

Temp: Fahrenheit / TC, SHC: kBtu/h / PI: kW

INDOOR		OUTDOOR TEMPERATURE (°FDB)																	
EWB	EDB	50			68			86			95			104			115		
°F	°F	TC	SHC	PI	TC	SHC	PI	TC	SHC	PI	TC	SHC	PI	TC	SHC	PI	TC	SHC	PI
57.2	68.0	11.86	9.13	0.57	10.87	8.65	0.71	9.88	8.19	0.84	9.39	7.95	0.91	8.90	7.73	0.98	8.30	7.45	1.06
60.8	71.6	12.35	8.96	0.57	11.36	8.51	0.71	10.37	8.07	0.85	9.88	7.85	0.91	9.38	7.64	0.98	8.79	7.38	1.06
64.4	77.0	12.84	9.42	0.58	11.85	9.00	0.71	10.86	8.59	0.85	10.37	8.39	0.92	9.87	8.19	0.99	9.28	7.95	1.07
67.0	80.0	13.08	9.97	0.58	12.09	9.57	0.72	11.11	9.18	0.85	10.60	8.98	0.92	10.12	8.79	0.99	9.52	8.56	1.07
71.6	86.0	13.82	9.61	0.59	12.83	9.26	0.72	11.84	8.91	0.86	11.34	8.74	0.93	10.85	8.57	1.00	10.26	8.37	1.08
75.2	89.6	14.30	9.36	0.73	13.32	9.04	0.73	12.33	8.73	0.86	11.83	8.57	0.93	11.34	8.42	1.00	10.75	8.23	1.08

**Heating (60 Hz, 230 V)**

AFR	11.7
-----	------

Temp: Celsius / TC, PI: kW

INDOOR		OUTDOOR TEMPERATURE (°CWB)															
EDB		-25		-20		-15		-10		-5		0		6		15.5	
°C		TC	PI	TC	PI	TC	PI	TC	PI	TC	PI	TC	PI	TC	PI	TC	PI
15.0		2.85	1.73	3.68	1.77	4.48	1.81	4.75	1.74	5.04	1.68	5.33	1.61	5.69	1.53	6.87	1.65
21.1		2.56	1.79	3.40	1.82	4.20	1.86	4.51	1.79	4.82	1.72	5.13	1.65	5.50	1.56	6.68	1.68
22.0		2.31	1.65	3.20	1.77	4.09	1.88	4.41	1.81	4.73	1.74	5.05	1.66	5.42	1.58	6.44	1.63
24.0		1.92	1.35	2.81	1.53	3.71	1.69	4.31	1.83	4.64	1.75	4.96	1.68	5.35	1.59	6.05	1.51
25.0		1.72	1.20	2.62	1.41	3.51	1.59	4.27	1.84	4.60	1.76	4.92	1.69	5.31	1.60	5.85	1.46
27.0		1.33	0.91	2.23	1.18	3.12	1.39	3.90	1.66	4.51	1.78	4.84	1.70	5.23	1.61	5.46	1.34

Temp: Fahrenheit / TC: kBtu/h / PI: kW

INDOOR		OUTDOOR TEMPERATURE (°FWB)															
EDB		-13		-4		5		14		23		32		43		60	
°F		TC	PI	TC	PI	TC	PI	TC	PI	TC	PI	TC	PI	TC	PI	TC	PI
59.0		9.73	1.73	12.55	1.77	15.27	1.81	16.23	1.74	17.21	1.68	18.22	1.61	19.45	1.53	23.48	1.65
70.0		8.72	1.79	11.58	1.82	14.33	1.86	15.39	1.79	16.46	1.72	17.52	1.65	18.80	1.56	22.83	1.68
71.6		7.88	1.65	10.93	1.77	13.95	1.88	15.06	1.81	16.16	1.74	17.24	1.66	18.54	1.58	21.97	1.63
75.2		6.55	1.35	9.60	1.53	12.65	1.69	14.73	1.83	15.85	1.75	16.96	1.68	18.28	1.59	20.64	1.51
77.0		5.88	1.20	8.93	1.41	11.98	1.59	14.56	1.84	15.70	1.76	16.82	1.69	18.15	1.60	19.97	1.46
80.6		4.55	0.91	7.60	1.18	10.65	1.39	13.32	1.66	15.40	1.78	16.54	1.70	17.89	1.61	18.64	1.34

**Symbols:**

- AFR : Airflow rate (m³/min.)
- BF : Bypass factor
- EWB : Entering wet bulb temp. (°C) / (°F)
- EDB : Entering dry bulb temp. (°C) / (°F)
- TC : Total capacity (kW) / (kBtu/h)
- SHC : Sensible heat capacity (kW) / (kBtu/h)
- PI : Power input (kW)

**Notes:**

1.  shows nominal (rated) capacities and power input (Cooling) and MAX capacities and power input (Heating).
2. TC, PI and SHC must be calculated by interpolation using the figures in the above tables. (Figures out of the tables should not be used for calculation.)
3. Capacities are based on the following conditions.  
Corresponding refrigerant piping length : 25 ft (7.5 m)  
Level difference : 0 ft (0 m)
4. Airflow rate (AFR) and Bypass factor (BF) are tabulated above table.

**FTX15WMVJU9 + RXL15WMVJU9**

**Cooling (60 Hz, 208 V)**

AFR	16.8
BF	0.22

Temp: Celsius / TC, SHC, PI: kW

INDOOR		OUTDOOR TEMPERATURE (°CDB)																	
EWB	EDB	10			20			30			35			40			46		
°C	°C	TC	SHC	PI	TC	SHC	PI	TC	SHC	PI	TC	SHC	PI	TC	SHC	PI	TC	SHC	PI
14.0	20.0	4.92	3.74	0.77	4.51	3.54	0.96	4.10	3.34	1.14	3.89	3.25	1.24	3.69	3.15	1.33	3.44	3.04	1.44
16.0	22.0	5.12	3.67	0.78	4.71	3.48	0.96	4.30	3.30	1.15	4.10	3.21	1.24	3.89	3.12	1.33	3.65	3.01	1.45
18.0	25.0	5.32	3.85	0.79	4.91	3.67	0.97	4.50	3.50	1.15	4.30	3.42	1.25	4.09	3.34	1.34	3.85	3.24	1.45
19.4	26.7	5.42	4.07	0.79	5.01	3.90	0.97	4.60	3.74	1.16	4.40	3.66	1.25	4.20	3.58	1.34	3.95	3.48	1.45
22.0	30.0	5.73	3.92	0.80	5.32	3.77	0.98	4.91	3.63	1.17	4.70	3.56	1.26	4.50	3.48	1.35	4.25	3.40	1.46
24.0	32.0	5.93	3.82	0.99	5.52	3.68	0.99	5.11	3.55	1.17	4.91	3.48	1.26	4.70	3.42	1.36	4.46	3.34	1.47

Temp: Fahrenheit / TC, SHC: kBtu/h / PI: kW

INDOOR		OUTDOOR TEMPERATURE (°FDB)																	
EWB	EDB	50			68			86			95			104			115		
°F	°F	TC	SHC	PI	TC	SHC	PI	TC	SHC	PI	TC	SHC	PI	TC	SHC	PI	TC	SHC	PI
57.2	68.0	16.78	12.76	0.77	15.38	12.08	0.96	13.98	11.41	1.14	13.28	11.08	1.24	12.58	10.75	1.33	11.75	10.37	1.44
60.8	71.6	17.47	12.51	0.78	16.07	11.87	0.96	14.67	11.24	1.15	13.98	10.94	1.24	13.28	10.63	1.33	12.44	10.27	1.45
64.4	77.0	18.16	13.13	0.79	16.76	12.53	0.97	15.37	11.95	1.15	14.67	11.66	1.25	13.97	11.38	1.34	13.13	11.04	1.45
67.0	80.0	18.51	13.88	0.79	17.11	13.31	0.97	15.71	12.75	1.16	15.00	12.47	1.25	15.00	12.20	1.34	13.47	11.88	1.45
71.6	86.0	19.55	13.38	0.80	18.15	12.87	0.98	16.75	12.37	1.17	16.05	12.13	1.26	15.35	11.89	1.35	14.51	11.60	1.46
75.2	89.6	20.24	13.02	0.99	18.84	12.56	0.99	17.44	12.11	1.17	16.74	11.89	1.26	16.04	11.67	1.36	15.20	11.41	1.47

**Heating (60 Hz, 208 V)**

AFR	18.5
-----	------

Temp: Celsius / TC, PI: kW

INDOOR		OUTDOOR TEMPERATURE (°CWB)															
EDB		-25		-20		-15		-10		-5		0		6		15.5	
°C		TC	PI	TC	PI	TC	PI	TC	PI	TC	PI	TC	PI	TC	PI	TC	PI
15.0		3.63	2.20	4.69	2.24	5.70	2.30	6.10	2.29	6.52	2.28	6.94	2.27	7.45	2.26	8.99	2.44
21.1		3.26	2.27	4.32	2.31	5.35	2.36	5.79	2.35	6.23	2.34	6.67	2.32	7.20	2.31	8.74	2.49
22.0		3.11	2.30	4.18	2.34	5.21	2.39	5.67	2.37	6.12	2.36	6.56	2.34	7.10	2.33	8.65	2.51
24.0		2.96	2.32	4.04	2.36	5.07	2.41	5.54	2.40	6.00	2.38	6.46	2.37	7.00	2.35	8.14	2.30
25.0		2.78	2.18	3.96	2.38	5.00	2.43	5.48	2.41	5.94	2.39	6.41	2.38	6.95	2.36	7.87	2.19
27.0		2.23	1.66	3.82	2.40	4.86	2.45	5.35	2.43	5.83	2.42	6.30	2.40	6.85	2.38	7.33	1.98

Temp: Fahrenheit / TC: kBtu/h / PI: kW

INDOOR		OUTDOOR TEMPERATURE (°FWB)															
EDB		-13		-4		5		14		23		32		43		60	
°F		TC	PI	TC	PI	TC	PI	TC	PI	TC	PI	TC	PI	TC	PI	TC	PI
59.0		12.42	2.20	16.03	2.24	19.50	2.30	20.87	2.29	22.28	2.28	23.71	2.27	25.45	2.26	30.73	2.44
70.0		11.14	2.27	14.79	2.31	18.30	2.36	19.80	2.35	21.30	2.34	22.80	2.32	24.60	2.31	29.88	2.49
71.6		10.63	2.30	14.30	2.34	17.82	2.39	19.37	2.37	20.91	2.36	22.44	2.34	24.26	2.33	29.54	2.51
75.2		10.11	2.32	13.80	2.36	17.34	2.41	18.94	2.40	20.52	2.38	22.07	2.37	23.92	2.35	27.78	2.30
77.0		9.47	2.18	13.56	2.38	17.10	2.43	18.73	2.41	20.32	2.39	21.89	2.38	23.75	2.36	26.85	2.19
80.6		7.62	1.66	13.06	2.40	16.62	2.45	18.30	2.43	19.93	2.42	21.53	2.40	23.41	2.38	25.00	1.98

**Cooling (60 Hz, 230 V)**

AFR	16.8
BF	0.22

Temp: Celsius / TC, SHC, PI: kW

INDOOR		OUTDOOR TEMPERATURE (°CDB)																	
EWB	EDB	10			20			30			35			40			46		
°C	°C	TC	SHC	PI	TC	SHC	PI	TC	SHC	PI	TC	SHC	PI	TC	SHC	PI	TC	SHC	PI
14.0	20.0	4.92	3.74	0.77	4.51	3.54	0.96	4.10	3.34	1.14	3.89	3.25	1.24	3.69	3.15	1.33	3.44	3.04	1.44
16.0	22.0	5.12	3.67	0.78	4.71	3.48	0.96	4.30	3.30	1.15	4.10	3.21	1.24	3.89	3.12	1.33	3.65	3.01	1.45
18.0	25.0	5.32	3.85	0.79	4.91	3.67	0.97	4.50	3.50	1.15	4.30	3.42	1.25	4.09	3.34	1.34	3.85	3.24	1.45
19.4	26.7	5.42	4.07	0.79	5.01	3.90	0.97	4.60	3.74	1.16	4.40	3.66	1.25	4.20	3.58	1.34	3.95	3.48	1.45
22.0	30.0	5.73	3.92	0.80	5.32	3.77	0.98	4.91	3.63	1.17	4.70	3.56	1.26	4.50	3.48	1.35	4.25	3.40	1.46
24.0	32.0	5.93	3.82	0.99	5.52	3.68	0.99	5.11	3.55	1.17	4.91	3.48	1.26	4.70	3.42	1.36	4.46	3.34	1.47

Temp: Fahrenheit / TC, SHC: kBtu/h / PI: kW

INDOOR		OUTDOOR TEMPERATURE (°FDB)																	
EWB	EDB	50			68			86			95			104			115		
°F	°F	TC	SHC	PI	TC	SHC	PI	TC	SHC	PI	TC	SHC	PI	TC	SHC	PI	TC	SHC	PI
57.2	68.0	16.78	12.76	0.77	15.38	12.08	0.96	13.98	11.41	1.14	13.28	11.08	1.24	12.58	10.75	1.33	11.75	10.37	1.44
60.8	71.6	17.47	12.51	0.78	16.07	11.87	0.96	14.67	11.24	1.15	13.98	10.94	1.24	13.28	10.63	1.33	12.44	10.27	1.45
64.4	77.0	18.16	13.13	0.79	16.76	12.53	0.97	15.37	11.95	1.15	14.67	11.66	1.25	13.97	11.38	1.34	13.13	11.04	1.45
67.0	80.0	18.51	13.88	0.79	17.11	13.31	0.97	15.71	12.75	1.16	15.00	12.47	1.25	15.00	12.20	1.34	13.47	11.88	1.45
71.6	86.0	19.55	13.38	0.80	18.15	12.87	0.98	16.75	12.37	1.17	16.05	12.13	1.26	15.35	11.89	1.35	14.51	11.60	1.46
75.2	89.6	20.24	13.02	0.99	18.84	12.56	0.99	17.44	12.11	1.17	16.74	11.89	1.26	16.04	11.67	1.36	15.20	11.41	1.47

**Heating (60 Hz, 230 V)**

AFR	18.5
-----	------

Temp: Celsius / TC, PI: kW

INDOOR		OUTDOOR TEMPERATURE (°CWB)															
EDB		-25		-20		-15		-10		-5		0		6		15.5	
°C		TC	PI	TC	PI	TC	PI	TC	PI	TC	PI	TC	PI	TC	PI	TC	PI
15.0		3.63	2.20	4.69	2.24	5.70	2.30	6.10	2.29	6.52	2.28	6.94	2.27	7.45	2.26	8.99	2.44
21.1		3.26	2.27	4.32	2.31	5.35	2.36	5.79	2.35	6.23	2.34	6.67	2.32	7.20	2.31	8.74	2.49
22.0		3.11	2.30	4.18	2.34	5.21	2.39	5.67	2.37	6.12	2.36	6.56	2.34	7.10	2.33	8.65	2.51
24.0		2.96	2.32	4.04	2.36	5.07	2.41	5.54	2.40	6.00	2.38	6.46	2.37	7.00	2.35	8.14	2.30
25.0		2.78	2.18	3.96	2.38	5.00	2.43	5.48	2.41	5.94	2.39	6.41	2.38	6.95	2.36	7.87	2.19
27.0		2.23	1.66	3.82	2.40	4.86	2.45	5.35	2.43	5.83	2.42	6.30	2.40	6.85	2.38	7.33	1.98

Temp: Fahrenheit / TC: kBtu/h / PI: kW

INDOOR		OUTDOOR TEMPERATURE (°FWB)															
EDB		-13		-4		5		14		23		32		43		60	
°F		TC	PI	TC	PI	TC	PI	TC	PI	TC	PI	TC	PI	TC	PI	TC	PI
59.0		12.42	2.20	16.03	2.24	19.50	2.30	20.87	2.29	22.28	2.28	23.71	2.27	25.45	2.26	30.73	2.44
70.0		11.14	2.27	14.79	2.31	18.30	2.36	19.80	2.35	21.30	2.34	22.80	2.32	24.60	2.31	29.88	2.49
71.6		10.63	2.30	14.30	2.34	17.82	2.39	19.37	2.37	20.91	2.36	22.44	2.34	24.26	2.33	29.54	2.51
75.2		10.11	2.32	13.80	2.36	17.34	2.41	18.94	2.40	20.52	2.38	22.07	2.37	23.92	2.35	27.78	2.30
77.0		9.47	2.18	13.56	2.38	17.10	2.43	18.73	2.41	20.32	2.39	21.89	2.38	23.75	2.36	26.85	2.19
80.6		7.62	1.66	13.06	2.40	16.62	2.45	18.30	2.43	19.93	2.42	21.53	2.40	23.41	2.38	25.00	1.98

**Symbols:**

- AFR : Airflow rate (m³/min.)
- BF : Bypass factor
- EWB : Entering wet bulb temp. (°C) / (°F)
- EDB : Entering dry bulb temp. (°C) / (°F)
- TC : Total capacity (kW) / (kBtu/h)
- SHC : Sensible heat capacity (kW) / (kBtu/h)
- PI : Power input (kW)

**Notes:**

1.  shows nominal (rated) capacities and power input (Cooling) and MAX capacities and power input (Heating).
2. TC, PI and SHC must be calculated by interpolation using the figures in the above tables. (Figures out of the tables should not be used for calculation.)
3. Capacities are based on the following conditions.  
Corresponding refrigerant piping length : 25 ft (7.5 m)  
Level difference : 0 ft (0 m)
4. Airflow rate (AFR) and Bypass factor (BF) are tabulated above table.

**FTX18WVJU9 + RXL18WMVJU9**

**Cooling (60 Hz, 208 V)**

AFR	16.5
BF	0.07

Temp: Celsius / TC, SHC, PI: kW

INDOOR		OUTDOOR TEMPERATURE (°CDB)																	
EWB	EDB	10			20			30			35			40			46		
°C	°C	TC	SHC	PI	TC	SHC	PI	TC	SHC	PI	TC	SHC	PI	TC	SHC	PI	TC	SHC	PI
14.0	20.0	5.90	4.45	0.97	5.40	4.21	1.20	4.91	3.97	1.43	4.67	3.85	1.55	4.42	3.74	1.66	4.13	3.60	1.80
16.0	22.0	6.14	4.36	0.98	5.65	4.13	1.21	5.16	3.91	1.44	4.91	3.80	1.55	4.67	3.70	1.67	4.37	3.57	1.81
18.0	25.0	6.38	4.57	0.98	5.89	4.36	1.21	5.40	4.15	1.45	5.15	4.05	1.56	4.91	3.95	1.68	4.61	3.83	1.82
19.4	26.7	6.50	4.83	0.99	6.01	4.62	1.22	5.52	4.43	1.45	5.28	4.33	1.57	5.03	4.23	1.68	4.74	4.12	1.82
22.0	30.0	6.87	4.65	1.00	6.38	4.47	1.23	5.89	4.30	1.46	5.64	4.21	1.58	5.39	4.12	1.69	5.10	4.02	1.83
24.0	32.0	7.11	4.52	1.24	6.62	4.36	1.24	6.13	4.20	1.47	5.88	4.12	1.58	5.64	4.05	1.70	5.34	3.95	1.84

Temp: Fahrenheit / TC, SHC: kBtu/h / PI: kW

INDOOR		OUTDOOR TEMPERATURE (°FDB)																	
EWB	EDB	50			68			86			95			104			115		
°F	°F	TC	SHC	PI	TC	SHC	PI	TC	SHC	PI	TC	SHC	PI	TC	SHC	PI	TC	SHC	PI
57.2	68.0	20.12	15.18	0.97	18.44	14.35	1.20	16.76	13.54	1.43	15.93	13.15	1.55	15.09	12.75	1.66	14.08	12.29	1.80
60.8	71.6	20.95	14.88	0.98	19.27	14.11	1.21	17.59	13.35	1.44	16.76	12.98	1.55	15.92	12.61	1.67	14.91	12.18	1.81
64.4	77.0	21.78	15.60	0.98	20.10	14.88	1.21	18.42	14.17	1.45	17.59	13.83	1.56	16.75	13.49	1.68	15.74	13.08	1.82
67.0	80.0	22.19	16.47	0.99	20.51	15.78	1.22	18.84	15.10	1.45	18.00	14.77	1.57	17.16	14.44	1.68	16.16	14.05	1.82
71.6	86.0	23.43	15.86	1.00	21.76	15.25	1.23	20.08	14.66	1.46	19.24	14.36	1.58	18.41	14.07	1.69	17.40	13.73	1.83
75.2	89.6	24.26	15.44	1.24	22.59	14.88	1.24	20.91	14.34	1.47	20.07	14.07	1.58	19.24	13.81	1.70	18.23	13.49	1.84

**Heating (60 Hz, 208 V)**

AFR	20.2
-----	------

Temp: Celsius / TC, PI: kW

INDOOR		OUTDOOR TEMPERATURE (°CWB)															
EDB		-25		-20		-15		-10		-5		0		6		15.5	
°C		TC	PI	TC	PI	TC	PI	TC	PI	TC	PI	TC	PI	TC	PI	TC	PI
15.0		4.94	2.46	5.83	2.77	6.75	3.08	7.14	3.06	7.56	3.05	7.98	3.03	8.49	3.01	10.25	3.26
21.1		4.43	2.53	5.38	2.85	6.33	3.17	6.78	3.15	7.22	3.13	7.67	3.11	8.21	3.08	9.97	3.33
22.0		3.82	2.16	5.20	2.88	6.16	3.20	6.63	3.18	7.09	3.16	7.55	3.14	8.09	3.11	9.85	3.35
24.0		3.17	1.77	4.65	2.55	6.00	3.23	6.48	3.21	6.96	3.19	7.43	3.17	7.98	3.14	9.74	3.38
25.0		2.84	1.57	4.33	2.34	5.91	3.25	6.41	3.23	6.89	3.20	7.36	3.18	7.92	3.15	9.68	3.39
27.0		2.19	1.19	3.68	1.93	5.38	2.90	6.26	3.26	6.76	3.23	7.24	3.21	7.81	3.18	9.42	3.32

Temp: Fahrenheit / TC: kBtu/h / PI: kW

INDOOR		OUTDOOR TEMPERATURE (°FWB)															
EDB		-13		-4		5		14		23		32		43		60	
°F		TC	PI	TC	PI	TC	PI	TC	PI	TC	PI	TC	PI	TC	PI	TC	PI
59.0		16.86	2.46	19.90	2.77	23.02	3.08	24.37	3.06	25.78	3.05	27.22	3.03	28.97	3.01	34.97	3.26
70.0		15.12	2.53	18.36	2.85	21.60	3.17	23.12	3.15	24.65	3.13	26.17	3.11	28.00	3.08	34.01	3.33
71.6		13.02	2.16	17.75	2.88	21.03	3.20	22.62	3.18	24.19	3.16	25.75	3.14	27.61	3.11	33.62	3.35
75.2		10.80	1.77	15.88	2.55	20.47	3.23	22.12	3.21	23.74	3.19	25.34	3.17	27.23	3.14	33.23	3.38
77.0		9.69	1.57	14.77	2.34	20.18	3.25	21.87	3.23	23.52	3.20	25.13	3.18	27.03	3.15	33.04	3.39
80.6		7.48	1.19	12.56	1.93	18.34	2.90	21.37	3.26	23.06	3.23	24.71	3.21	26.65	3.18	32.13	3.32

**Cooling (60 Hz, 230 V)**

AFR	16.5
BF	0.07

Temp: Celsius / TC, SHC, PI: kW

INDOOR		OUTDOOR TEMPERATURE (°CDB)																	
EWB	EDB	10			20			30			35			40			46		
°C	°C	TC	SHC	PI	TC	SHC	PI	TC	SHC	PI	TC	SHC	PI	TC	SHC	PI	TC	SHC	PI
14.0	20.0	5.90	4.45	0.97	5.40	4.21	1.20	4.91	3.97	1.43	4.67	3.85	1.55	4.42	3.74	1.66	4.13	3.60	1.80
16.0	22.0	6.14	4.36	0.98	5.65	4.13	1.21	5.16	3.91	1.44	4.91	3.80	1.55	4.67	3.70	1.67	4.37	3.57	1.81
18.0	25.0	6.38	4.57	0.98	5.89	4.36	1.21	5.40	4.15	1.45	5.15	4.05	1.56	4.91	3.95	1.68	4.61	3.83	1.82
19.4	26.7	6.50	4.83	0.99	6.01	4.62	1.22	5.52	4.43	1.45	5.28	4.33	1.57	5.03	4.23	1.68	4.74	4.12	1.82
22.0	30.0	6.87	4.65	1.00	6.38	4.47	1.23	5.89	4.30	1.46	5.64	4.21	1.58	5.39	4.12	1.69	5.10	4.02	1.83
24.0	32.0	7.11	4.52	1.24	6.62	4.36	1.24	6.13	4.20	1.47	5.88	4.12	1.58	5.64	4.05	1.70	5.34	3.95	1.84

Temp: Fahrenheit / TC, SHC: kBtu/h / PI: kW

INDOOR		OUTDOOR TEMPERATURE (°FDB)																	
EWB	EDB	50			68			86			95			104			115		
°F	°F	TC	SHC	PI	TC	SHC	PI	TC	SHC	PI	TC	SHC	PI	TC	SHC	PI	TC	SHC	PI
57.2	68.0	20.12	15.18	0.97	18.44	14.35	1.20	16.76	13.54	1.43	15.93	13.15	1.55	15.09	12.75	1.66	14.08	12.29	1.80
60.8	71.6	20.95	14.88	0.98	19.27	14.11	1.21	17.59	13.35	1.44	16.76	12.98	1.55	15.92	12.61	1.67	14.91	12.18	1.81
64.4	77.0	21.78	15.60	0.98	20.10	14.88	1.21	18.42	14.17	1.45	17.59	13.83	1.56	16.75	13.49	1.68	15.74	13.08	1.82
67.0	80.0	22.19	16.47	0.99	20.51	15.78	1.22	18.84	15.10	1.45	18.00	14.77	1.57	17.16	14.44	1.68	16.16	14.05	1.82
71.6	86.0	23.43	15.86	1.00	21.76	15.25	1.23	20.08	14.66	1.46	19.24	14.36	1.58	18.41	14.07	1.69	17.40	13.73	1.83
75.2	89.6	24.26	15.44	1.24	22.59	14.88	1.24	20.91	14.34	1.47	20.07	14.07	1.58	19.24	13.81	1.70	18.23	13.49	1.84

**Heating (60 Hz, 230 V)**

AFR	20.2
-----	------

Temp: Celsius / TC, PI: kW

INDOOR		OUTDOOR TEMPERATURE (°CWB)															
EDB		-25		-20		-15		-10		-5		0		6		15.5	
°C		TC	PI	TC	PI	TC	PI	TC	PI	TC	PI	TC	PI	TC	PI	TC	PI
15.0		4.94	2.46	5.83	2.77	6.75	3.08	7.14	3.06	7.56	3.05	7.98	3.03	8.49	3.01	10.25	3.26
21.1		4.43	2.53	5.38	2.85	6.33	3.17	6.78	3.15	7.22	3.13	7.67	3.11	8.21	3.08	9.97	3.33
22.0		3.82	2.16	5.20	2.88	6.16	3.20	6.63	3.18	7.09	3.16	7.55	3.14	8.09	3.11	9.85	3.35
24.0		3.17	1.77	4.65	2.55	6.00	3.23	6.48	3.21	6.96	3.19	7.43	3.17	7.98	3.14	9.74	3.38
25.0		2.84	1.57	4.33	2.34	5.91	3.25	6.41	3.23	6.89	3.20	7.36	3.18	7.92	3.15	9.68	3.39
27.0		2.19	1.19	3.68	1.93	5.38	2.90	6.26	3.26	6.76	3.23	7.24	3.21	7.81	3.18	9.42	3.32

Temp: Fahrenheit / TC: kBtu/h / PI: kW

INDOOR		OUTDOOR TEMPERATURE (°FWB)															
EDB		-13		-4		5		14		23		32		43		60	
°F		TC	PI	TC	PI	TC	PI	TC	PI	TC	PI	TC	PI	TC	PI	TC	PI
59.0		16.86	2.46	19.90	2.77	23.02	3.08	24.37	3.06	25.78	3.05	27.22	3.03	28.97	3.01	34.97	3.26
70.0		15.12	2.53	18.36	2.85	21.60	3.17	23.12	3.15	24.65	3.13	26.17	3.11	28.00	3.08	34.01	3.33
71.6		13.02	2.16	17.75	2.88	21.03	3.20	22.62	3.18	24.19	3.16	25.75	3.14	27.61	3.11	33.62	3.35
75.2		10.80	1.77	15.88	2.55	20.47	3.23	22.12	3.21	23.74	3.19	25.34	3.17	27.23	3.14	33.23	3.38
77.0		9.69	1.57	14.77	2.34	20.18	3.25	21.87	3.23	23.52	3.20	25.13	3.18	27.03	3.15	33.04	3.39
80.6		7.48	1.19	12.56	1.93	18.34	2.90	21.37	3.26	23.06	3.23	24.71	3.21	26.65	3.18	32.13	3.32

**Symbols:**

- AFR : Airflow rate (m³/min.)
- BF : Bypass factor
- EWB : Entering wet bulb temp. (°C) / (°F)
- EDB : Entering dry bulb temp. (°C) / (°F)
- TC : Total capacity (kW) / (kBtu/h)
- SHC : Sensible heat capacity (kW) / (kBtu/h)
- PI : Power input (kW)

**Notes:**

1.  shows nominal (rated) capacities and power input (Cooling) and MAX capacities and power input (Heating).
2. TC, PI and SHC must be calculated by interpolation using the figures in the above tables. (Figures out of the tables should not be used for calculation.)
3. Capacities are based on the following conditions.  
Corresponding refrigerant piping length : 25 ft (7.5 m)  
Level difference : 0 ft (0 m)
4. Airflow rate (AFR) and Bypass factor (BF) are tabulated above table.

**FTX24WVJU9 + RXL24WMVJU9**

**Cooling (60 Hz, 208 V)**

AFR	18.2
BF	0.08

Temp: Celsius / TC, SHC, PI: kW

INDOOR		OUTDOOR TEMPERATURE (°CDB)																	
EWB	EDB	10			20			30			35			40			46		
°C	°C	TC	SHC	PI	TC	SHC	PI	TC	SHC	PI	TC	SHC	PI	TC	SHC	PI	TC	SHC	PI
14.0	20.0	6.94	5.11	1.14	6.37	4.82	1.41	5.79	4.54	1.69	5.50	4.40	1.82	5.21	4.26	1.96	4.86	4.10	2.12
16.0	22.0	7.23	5.01	1.15	6.65	4.74	1.42	6.07	4.47	1.69	5.78	4.34	1.83	5.49	4.21	1.97	5.15	4.06	2.13
18.0	25.0	7.52	5.23	1.16	6.94	4.98	1.43	6.36	4.73	1.70	6.07	4.61	1.84	5.78	4.49	1.98	5.43	4.34	2.14
19.4	26.7	7.66	5.51	1.16	7.08	5.26	1.43	6.50	5.02	1.71	6.20	4.91	1.84	5.92	4.79	1.98	5.58	4.65	2.14
22.0	30.0	8.09	5.29	1.17	7.51	5.08	1.45	6.93	4.87	1.72	6.64	4.76	1.86	6.35	4.66	1.99	6.01	4.54	2.16
24.0	32.0	8.38	5.15	1.46	7.80	4.95	1.46	7.22	4.76	1.73	6.93	4.66	1.86	6.64	4.57	2.00	6.29	4.46	2.16

Temp: Fahrenheit / TC, SHC: kBtu/h / PI: kW

INDOOR		OUTDOOR TEMPERATURE (°FDB)																	
EWB	EDB	50			68			86			95			104			115		
°F	°F	TC	SHC	PI	TC	SHC	PI	TC	SHC	PI	TC	SHC	PI	TC	SHC	PI	TC	SHC	PI
57.2	68.0	23.69	17.44	1.14	21.72	16.45	1.41	19.75	15.48	1.69	18.76	15.00	1.82	17.77	14.53	1.96	16.59	13.97	2.12
60.8	71.6	24.67	17.09	1.15	22.70	16.16	1.42	20.72	15.25	1.69	19.73	14.81	1.83	18.75	14.37	1.97	17.56	13.85	2.13
64.4	77.0	25.65	17.84	1.16	23.67	16.98	1.43	21.70	16.13	1.70	20.71	15.72	1.84	19.72	15.31	1.98	18.54	14.82	2.14
67.0	80.0	26.14	18.79	1.16	24.16	17.95	1.43	22.19	17.14	1.71	21.20	16.74	1.84	20.21	16.34	1.98	19.03	15.88	2.14
71.6	86.0	27.60	18.06	1.17	25.63	17.33	1.45	23.65	16.61	1.72	22.67	16.26	1.86	21.68	15.91	1.99	20.49	15.50	2.16
75.2	89.6	28.58	17.56	1.46	26.60	16.89	1.46	24.63	16.23	1.73	23.64	15.91	1.86	22.65	15.59	2.00	21.47	15.22	2.16

**Heating (60 Hz, 208 V)**

AFR	19.8
-----	------

Temp: Celsius / TC, PI: kW

INDOOR		OUTDOOR TEMPERATURE (°CWB)															
EDB		-25		-20		-15		-10		-5		0		6		15.5	
°C		TC	PI	TC	PI	TC	PI	TC	PI	TC	PI	TC	PI	TC	PI	TC	PI
15.0		5.49	3.03	6.48	3.42	7.50	3.80	8.00	3.78	8.52	3.76	9.06	3.74	9.70	3.71	11.51	3.91
21.1		4.81	3.04	5.98	3.52	7.03	3.91	7.59	3.88	8.15	3.86	8.71	3.83	9.38	3.80	11.02	3.91
22.0		4.11	2.67	5.72	3.51	6.81	3.91	7.42	3.91	8.00	3.89	8.57	3.87	9.25	3.83	10.84	3.91
24.0		3.41	2.27	5.02	3.12	6.59	3.91	7.21	3.91	7.83	3.91	8.43	3.90	9.12	3.87	10.66	3.91
25.0		3.06	2.07	4.67	2.93	6.49	3.91	7.11	3.91	7.73	3.91	8.35	3.91	9.05	3.89	10.57	3.91
27.0		2.36	1.64	3.97	2.52	5.80	3.55	6.91	3.91	7.54	3.91	8.16	3.91	8.92	3.91	10.15	3.80

Temp: Fahrenheit / TC: kBtu/h / PI: kW

INDOOR		OUTDOOR TEMPERATURE (°FWB)															
EDB		-13		-4		5		14		23		32		43		60	
°F		TC	PI	TC	PI	TC	PI	TC	PI	TC	PI	TC	PI	TC	PI	TC	PI
59.0		18.73	3.03	22.11	3.42	25.58	3.80	27.30	3.78	29.09	3.76	30.90	3.74	33.10	3.71	39.26	3.91
70.0		16.42	3.04	20.40	3.52	24.00	3.91	25.90	3.88	27.81	3.86	29.71	3.83	32.00	3.80	37.61	3.91
71.6		14.04	2.67	19.51	3.51	23.25	3.91	25.31	3.91	27.30	3.89	29.24	3.87	31.56	3.83	36.98	3.91
75.2		11.65	2.27	17.12	3.12	22.50	3.91	24.61	3.91	26.71	3.91	28.77	3.90	31.12	3.87	36.36	3.91
77.0		10.45	2.07	15.93	2.93	22.13	3.91	24.26	3.91	26.38	3.91	28.49	3.91	30.90	3.89	36.05	3.91
80.6		8.06	1.64	13.54	2.52	19.78	3.55	23.59	3.91	25.73	3.91	27.86	3.91	30.42	3.91	34.64	3.80

**Cooling (60 Hz, 230 V)**

AFR	18.2
BF	0.08

Temp: Celsius / TC, SHC, PI: kW

INDOOR		OUTDOOR TEMPERATURE (°CDB)																	
EWB	EDB	10			20			30			35			40			46		
°C	°C	TC	SHC	PI	TC	SHC	PI	TC	SHC	PI	TC	SHC	PI	TC	SHC	PI	TC	SHC	PI
14.0	20.0	6.94	5.11	1.14	6.37	4.82	1.41	5.79	4.54	1.69	5.50	4.40	1.82	5.21	4.26	1.96	4.86	4.10	2.12
16.0	22.0	7.23	5.01	1.15	6.65	4.74	1.42	6.07	4.47	1.69	5.78	4.34	1.83	5.49	4.21	1.97	5.15	4.06	2.13
18.0	25.0	7.52	5.23	1.16	6.94	4.98	1.43	6.36	4.73	1.70	6.07	4.61	1.84	5.78	4.49	1.98	5.43	4.34	2.14
19.4	26.7	7.66	5.51	1.16	7.08	5.26	1.43	6.50	5.02	1.71	6.20	4.91	1.84	5.92	4.79	1.98	5.58	4.65	2.14
22.0	30.0	8.09	5.29	1.17	7.51	5.08	1.45	6.93	4.87	1.72	6.64	4.76	1.86	6.35	4.66	1.99	6.01	4.54	2.16
24.0	32.0	8.38	5.15	1.46	7.80	4.95	1.46	7.22	4.76	1.73	6.93	4.66	1.86	6.64	4.57	2.00	6.29	4.46	2.16

Temp: Fahrenheit / TC, SHC: kBtu/h / PI: kW

INDOOR		OUTDOOR TEMPERATURE (°FDB)																	
EWB	EDB	50			68			86			95			104			115		
°F	°F	TC	SHC	PI	TC	SHC	PI	TC	SHC	PI	TC	SHC	PI	TC	SHC	PI	TC	SHC	PI
57.2	68.0	23.69	17.44	1.14	21.72	16.45	1.41	19.75	15.48	1.69	18.76	15.00	1.82	17.77	14.53	1.96	16.59	13.97	2.12
60.8	71.6	24.67	17.09	1.15	22.70	16.16	1.42	20.72	15.25	1.69	19.73	14.81	1.83	18.75	14.37	1.97	17.56	13.85	2.13
64.4	77.0	25.65	17.84	1.16	23.67	16.98	1.43	21.70	16.13	1.70	20.71	15.72	1.84	19.72	15.31	1.98	18.54	14.82	2.14
67.0	80.0	26.14	18.79	1.16	24.16	17.95	1.43	22.19	17.14	1.71	21.20	16.74	1.84	20.21	16.34	1.98	19.03	15.88	2.14
71.6	86.0	27.60	18.06	1.17	25.63	17.33	1.45	23.65	16.61	1.72	22.67	16.26	1.86	21.68	15.91	1.99	20.49	15.50	2.16
75.2	89.6	28.58	17.56	1.46	26.60	16.89	1.46	24.63	16.23	1.73	23.64	15.91	1.86	22.65	15.59	2.00	21.47	15.22	2.16

**Heating (60 Hz, 230 V)**

AFR	19.8
-----	------

Temp: Celsius / TC, PI: kW

INDOOR		OUTDOOR TEMPERATURE (°CWB)															
EDB		-25		-20		-15		-10		-5		0		6		15.5	
°C		TC	PI	TC	PI	TC	PI	TC	PI	TC	PI	TC	PI	TC	PI	TC	PI
15.0		5.49	3.03	6.48	3.42	7.50	3.80	8.00	3.78	8.52	3.76	9.06	3.74	9.70	3.71	11.71	4.01
21.1		4.81	3.04	5.98	3.52	7.03	3.91	7.59	3.88	8.15	3.86	8.71	3.83	9.38	3.80	11.39	4.10
22.0		4.11	2.67	5.72	3.51	6.85	3.95	7.43	3.92	8.00	3.89	8.57	3.87	9.25	3.83	11.26	4.13
24.0		3.41	2.27	5.02	3.12	6.66	3.99	7.26	3.96	7.85	3.93	8.43	3.90	9.12	3.87	11.13	4.17
25.0		3.06	2.07	4.67	2.93	6.50	3.95	7.18	3.98	7.78	3.95	8.36	3.92	9.05	3.89	10.85	4.07
27.0		2.36	1.64	3.97	2.52	5.80	3.55	7.02	4.02	7.63	3.99	8.22	3.96	8.93	3.92	10.15	3.80

Temp: Fahrenheit / TC: kBtu/h / PI: kW

INDOOR		OUTDOOR TEMPERATURE (°FWB)															
EDB		-13		-4		5		14		23		32		43		60	
°F		TC	PI	TC	PI	TC	PI	TC	PI	TC	PI	TC	PI	TC	PI	TC	PI
59.0		18.73	3.03	22.11	3.42	25.58	3.80	27.30	3.78	29.09	3.76	30.90	3.74	33.10	3.71	39.97	4.01
70.0		16.42	3.04	20.40	3.52	24.00	3.91	25.90	3.88	27.81	3.86	29.71	3.83	32.00	3.80	38.87	4.10
71.6		14.04	2.67	19.51	3.51	23.37	3.95	25.34	3.92	27.30	3.89	29.24	3.87	31.56	3.83	38.42	4.13
75.2		11.65	2.27	17.12	3.12	22.74	3.99	24.78	3.96	26.79	3.93	28.77	3.90	31.12	3.87	37.98	4.17
77.0		10.45	2.07	15.93	2.93	22.17	3.95	24.50	3.98	26.53	3.95	28.53	3.92	30.90	3.89	37.03	4.07
80.6		8.06	1.64	13.54	2.52	19.78	3.55	23.94	4.02	26.02	3.99	28.05	3.96	30.45	3.92	34.64	3.80

**Symbols:**

- AFR : Airflow rate (m³/min.)
- BF : Bypass factor
- EWB : Entering wet bulb temp. (°C) / (°F)
- EDB : Entering dry bulb temp. (°C) / (°F)
- TC : Total capacity (kW) / (kBtu/h)
- SHC : Sensible heat capacity (kW) / (kBtu/h)
- PI : Power input (kW)

**Notes:**

1.  shows nominal (rated) capacities and power input (Cooling) and MAX capacities and power input (Heating).
2. TC, PI and SHC must be calculated by interpolation using the figures in the above tables. (Figures out of the tables should not be used for calculation.)
3. Capacities are based on the following conditions.  
Corresponding refrigerant piping length : 25 ft (7.5 m)  
Level difference : 0 ft (0 m)
4. Airflow rate (AFR) and Bypass factor (BF) are tabulated above table.



**FVXS09WVJU9 + RXL09WMVJU9**

**Cooling (60 Hz, 208 V)**

AFR	8.2
BF	0.10

Temp: Celsius / TC, SHC, PI: kW

INDOOR		OUTDOOR TEMPERATURE (°CDB)																	
EWB	EDB	10			20			30			35			40			46		
°C	°C	TC	SHC	PI	TC	SHC	PI	TC	SHC	PI	TC	SHC	PI	TC	SHC	PI	TC	SHC	PI
14.0	20.0	2.95	2.20	0.48	2.70	2.07	0.60	2.46	1.95	0.72	2.34	1.90	0.77	2.21	1.84	0.83	2.07	1.77	0.90
16.0	22.0	3.07	2.15	0.49	2.83	2.04	0.60	2.58	1.93	0.72	2.46	1.87	0.78	2.33	1.82	0.83	2.19	1.75	0.90
18.0	25.0	3.19	2.25	0.49	2.95	2.15	0.61	2.70	2.04	0.72	2.58	1.99	0.78	2.46	1.94	0.84	2.31	1.88	0.91
19.4	26.7	3.25	2.38	0.49	3.01	2.27	0.61	2.76	2.17	0.72	2.64	2.12	0.78	2.52	2.07	0.84	2.37	2.02	0.91
22.0	30.0	3.44	2.29	0.50	3.19	2.19	0.61	2.95	2.11	0.73	2.82	2.06	0.79	2.70	2.02	0.84	2.55	1.97	0.91
24.0	32.0	3.56	2.22	0.62	3.31	2.14	0.62	3.07	2.06	0.73	2.94	2.02	0.79	2.82	1.98	0.85	2.67	1.93	0.92

Temp: Fahrenheit / TC, SHC: kBtu/h / PI: kW

INDOOR		OUTDOOR TEMPERATURE (°FDB)																	
EWB	EDB	50			68			86			95			104			115		
°F	°F	TC	SHC	PI	TC	SHC	PI	TC	SHC	PI	TC	SHC	PI	TC	SHC	PI	TC	SHC	PI
57.2	68.0	10.07	7.50	0.48	9.23	7.08	0.60	8.39	6.67	0.72	7.97	6.47	0.77	7.55	6.27	0.83	7.05	6.04	0.90
60.8	71.6	10.48	7.35	0.49	9.64	6.96	0.60	8.80	6.57	0.72	8.39	6.39	0.78	7.97	6.20	0.83	7.46	5.98	0.90
64.4	77.0	10.90	7.69	0.49	10.06	7.32	0.61	9.22	6.97	0.72	8.80	6.79	0.78	8.38	6.62	0.84	7.88	6.41	0.91
67.0	80.0	11.10	8.10	0.49	10.27	7.75	0.61	9.43	7.41	0.72	9.00	7.24	0.78	9.00	7.08	0.84	8.08	6.88	0.91
71.6	86.0	11.73	7.80	0.50	10.89	7.49	0.61	10.05	7.19	0.73	9.63	7.04	0.79	9.21	6.89	0.84	8.71	6.72	0.91
75.2	89.6	12.14	7.58	0.62	11.30	7.30	0.62	10.46	7.03	0.73	10.05	6.89	0.79	9.63	6.76	0.85	9.12	6.60	0.92

**Heating (60 Hz, 208 V)**

AFR	8.8
-----	-----

Temp: Celsius / TC, PI: kW

INDOOR		OUTDOOR TEMPERATURE (°CWB)															
EDB		-25		-20		-15		-10		-5		0		6		15.5	
°C		TC	PI	TC	PI	TC	PI	TC	PI	TC	PI	TC	PI	TC	PI	TC	PI
15.0		2.00	1.29	2.58	1.32	3.14	1.35	3.42	1.34	3.71	1.34	4.00	1.33	4.34	1.33	4.90	1.43
21.1		1.80	1.33	2.38	1.35	2.95	1.38	3.25	1.38	3.55	1.37	3.84	1.36	4.20	1.36	4.77	1.46
22.0		1.71	1.35	2.30	1.37	2.87	1.40	3.18	1.39	3.48	1.38	3.78	1.38	4.14	1.37	4.71	1.47
24.0		1.63	1.36	2.23	1.39	2.71	1.35	3.11	1.41	3.41	1.40	3.72	1.39	4.08	1.38	4.66	1.49
25.0		1.59	1.37	2.07	1.28	2.55	1.26	3.07	1.41	3.38	1.40	3.69	1.40	4.06	1.39	4.63	1.49
27.0		1.35	1.18	1.75	1.07	2.23	1.09	3.00	1.43	3.32	1.42	3.63	1.41	4.00	1.40	4.46	1.44

Temp: Fahrenheit / TC: kBtu/h / PI: kW

INDOOR		OUTDOOR TEMPERATURE (°FWB)															
EDB		-13		-4		5		14		23		32		43		60	
°F		TC	PI	TC	PI	TC	PI	TC	PI	TC	PI	TC	PI	TC	PI	TC	PI
59.0		6.86	1.29	8.85	1.32	10.76	1.35	11.70	1.34	12.66	1.34	13.62	1.33	14.79	1.33	16.66	1.43
70.0		6.15	1.33	8.16	1.35	10.10	1.38	11.10	1.38	12.10	1.37	13.10	1.36	14.30	1.36	16.20	1.46
71.6		5.86	1.35	7.89	1.37	9.83	1.40	10.86	1.39	11.88	1.38	12.89	1.38	14.10	1.37	16.02	1.47
75.2		5.58	1.36	7.60	1.39	9.23	1.35	10.62	1.41	11.66	1.40	12.68	1.39	13.91	1.38	15.83	1.49
77.0		5.44	1.37	7.06	1.28	8.69	1.26	10.50	1.41	11.54	1.40	12.58	1.40	13.81	1.39	15.74	1.49
80.6		4.62	1.18	5.97	1.07	7.60	1.09	10.26	1.43	11.32	1.42	12.37	1.41	13.61	1.40	15.20	1.44



**Cooling (60 Hz, 230 V)**

AFR	8.2
BF	0.10

Temp: Celsius / TC, SHC, PI: kW

INDOOR		OUTDOOR TEMPERATURE (°CDB)																	
EWB	EDB	10			20			30			35			40			46		
°C	°C	TC	SHC	PI	TC	SHC	PI	TC	SHC	PI	TC	SHC	PI	TC	SHC	PI	TC	SHC	PI
14.0	20.0	2.95	2.20	0.48	2.70	2.07	0.60	2.46	1.95	0.72	2.34	1.90	0.77	2.21	1.84	0.83	2.07	1.77	0.90
16.0	22.0	3.07	2.15	0.49	2.83	2.04	0.60	2.58	1.93	0.72	2.46	1.87	0.78	2.33	1.82	0.83	2.19	1.75	0.90
18.0	25.0	3.19	2.25	0.49	2.95	2.15	0.61	2.70	2.04	0.72	2.58	1.99	0.78	2.46	1.94	0.84	2.31	1.88	0.91
19.4	26.7	3.25	2.38	0.49	3.01	2.27	0.61	2.76	2.17	0.72	2.64	2.12	0.78	2.52	2.07	0.84	2.37	2.02	0.91
22.0	30.0	3.44	2.29	0.50	3.19	2.19	0.61	2.95	2.11	0.73	2.82	2.06	0.79	2.70	2.02	0.84	2.55	1.97	0.91
24.0	32.0	3.56	2.22	0.62	3.31	2.14	0.62	3.07	2.06	0.73	2.94	2.02	0.79	2.82	1.98	0.85	2.67	1.93	0.92

Temp: Fahrenheit / TC, SHC: kBtu/h / PI: kW

INDOOR		OUTDOOR TEMPERATURE (°FDB)																	
EWB	EDB	50			68			86			95			104			115		
°F	°F	TC	SHC	PI	TC	SHC	PI	TC	SHC	PI	TC	SHC	PI	TC	SHC	PI	TC	SHC	PI
57.2	68.0	10.07	7.50	0.48	9.23	7.08	0.60	8.39	6.67	0.72	7.97	6.47	0.77	7.55	6.27	0.83	7.05	6.04	0.90
60.8	71.6	10.48	7.35	0.49	9.64	6.96	0.60	8.80	6.57	0.72	8.39	6.39	0.78	7.97	6.20	0.83	7.46	5.98	0.90
64.4	77.0	10.90	7.69	0.49	10.06	7.32	0.61	9.22	6.97	0.72	8.80	6.79	0.78	8.38	6.62	0.84	7.88	6.41	0.91
67.0	80.0	11.10	8.10	0.49	10.27	7.75	0.61	9.43	7.41	0.72	9.00	7.24	0.78	9.00	7.08	0.84	8.08	6.88	0.91
71.6	86.0	11.73	7.80	0.50	10.89	7.49	0.61	10.05	7.19	0.73	9.63	7.04	0.79	9.21	6.89	0.84	8.71	6.72	0.91
75.2	89.6	12.14	7.58	0.62	11.30	7.30	0.62	10.46	7.03	0.73	10.05	6.89	0.79	9.63	6.76	0.85	9.12	6.60	0.92

**Heating (60 Hz, 230 V)**

AFR	8.8
-----	-----

Temp: Celsius / TC, PI: kW

INDOOR		OUTDOOR TEMPERATURE (°CWB)															
EDB		-25		-20		-15		-10		-5		0		6		15.5	
°C		TC	PI	TC	PI	TC	PI	TC	PI	TC	PI	TC	PI	TC	PI	TC	PI
15.0		2.00	1.29	2.58	1.32	3.14	1.35	3.42	1.34	3.71	1.34	4.00	1.33	4.34	1.33	4.90	1.43
21.1		1.80	1.33	2.38	1.35	2.95	1.38	3.25	1.38	3.55	1.37	3.84	1.36	4.20	1.36	4.77	1.46
22.0		1.71	1.35	2.30	1.37	2.87	1.40	3.18	1.39	3.48	1.38	3.78	1.38	4.14	1.37	4.71	1.47
24.0		1.63	1.36	2.23	1.39	2.71	1.35	3.11	1.41	3.41	1.40	3.72	1.39	4.08	1.38	4.66	1.49
25.0		1.59	1.37	2.07	1.28	2.55	1.26	3.07	1.41	3.38	1.40	3.69	1.40	4.06	1.39	4.63	1.49
27.0		1.35	1.18	1.75	1.07	2.23	1.09	3.00	1.43	3.32	1.42	3.63	1.41	4.00	1.40	4.46	1.44

Temp: Fahrenheit / TC: kBtu/h / PI: kW

INDOOR		OUTDOOR TEMPERATURE (°FWB)															
EDB		-13		-4		5		14		23		32		43		60	
°F		TC	PI	TC	PI	TC	PI	TC	PI	TC	PI	TC	PI	TC	PI	TC	PI
59.0		6.86	1.29	8.85	1.32	10.76	1.35	11.70	1.34	12.66	1.34	13.62	1.33	14.79	1.33	16.66	1.43
70.0		6.15	1.33	8.16	1.35	10.10	1.38	11.10	1.38	12.10	1.37	13.10	1.36	14.30	1.36	16.20	1.46
71.6		5.86	1.35	7.89	1.37	9.83	1.40	10.86	1.39	11.88	1.38	12.89	1.38	14.10	1.37	16.02	1.47
75.2		5.58	1.36	7.60	1.39	9.23	1.35	10.62	1.41	11.66	1.40	12.68	1.39	13.91	1.38	15.83	1.49
77.0		5.44	1.37	7.06	1.28	8.69	1.26	10.50	1.41	11.54	1.40	12.58	1.40	13.81	1.39	15.74	1.49
80.6		4.62	1.18	5.97	1.07	7.60	1.09	10.26	1.43	11.32	1.42	12.37	1.41	13.61	1.40	15.20	1.44

**Symbols:**

- AFR : Airflow rate (m³/min.)
- BF : Bypass factor
- EWB : Entering wet bulb temp. (°C) / (°F)
- EDB : Entering dry bulb temp. (°C) / (°F)
- TC : Total capacity (kW) / (kBtu/h)
- SHC : Sensible heat capacity (kW) / (kBtu/h)
- PI : Power input (kW)

**Notes:**

1.  shows nominal (rated) capacities and power input (Cooling) and MAX capacities and power input (Heating).
2. TC, PI and SHC must be calculated by interpolation using the figures in the above tables. (Figures out of the tables should not be used for calculation.)
3. Capacities are based on the following conditions.  
Corresponding refrigerant piping length : 25 ft (7.5 m)  
Level difference : 0 ft (0 m)
4. Airflow rate (AFR) and Bypass factor (BF) are tabulated above table.

### FVXS12WVJU9 + RXL12WMVJU9

**Cooling (60 Hz, 208 V)**

AFR	8.5
BF	0.11

Temp: Celsius / TC, SHC, PI: kW

INDOOR		OUTDOOR TEMPERATURE (°CDB)																	
EWB	EDB	10			20			30			35			40			46		
°C	°C	TC	SHC	PI	TC	SHC	PI	TC	SHC	PI	TC	SHC	PI	TC	SHC	PI	TC	SHC	PI
14.0	20.0	3.35	2.42	0.57	3.07	2.28	0.71	2.79	2.14	0.85	2.65	2.07	0.92	2.51	2.00	0.99	2.35	1.92	1.07
16.0	22.0	3.49	2.37	0.58	3.21	2.24	0.72	2.93	2.11	0.85	2.79	2.04	0.92	2.65	1.98	0.99	2.49	1.90	1.07
18.0	25.0	3.63	2.47	0.58	3.35	2.34	0.72	3.07	2.22	0.86	2.93	2.16	0.92	2.79	2.10	0.99	2.62	2.03	1.08
19.4	26.7	3.70	2.59	0.58	3.42	2.47	0.72	3.14	2.35	0.86	3.00	2.29	0.93	2.86	2.24	1.00	2.69	2.17	1.08
22.0	30.0	3.91	2.49	0.59	3.63	2.38	0.73	3.35	2.28	0.86	3.21	2.23	0.93	3.07	2.18	1.00	2.90	2.12	1.08
24.0	32.0	4.04	2.42	0.59	3.76	2.32	0.73	3.49	2.22	0.87	3.35	2.18	0.94	3.21	2.13	1.01	3.04	2.08	1.09

Temp: Fahrenheit / TC, SHC: kBtu/h / PI: kW

INDOOR		OUTDOOR TEMPERATURE (°FDB)																	
EWB	EDB	50			68			86			95			104			115		
°F	°F	TC	SHC	PI	TC	SHC	PI	TC	SHC	PI	TC	SHC	PI	TC	SHC	PI	TC	SHC	PI
57.2	68.0	11.44	8.26	0.57	10.49	7.77	0.71	9.53	7.29	0.85	9.06	7.06	0.92	8.58	6.83	0.99	8.01	6.56	1.07
60.8	71.6	11.91	8.09	0.58	10.96	7.63	0.72	10.01	7.19	0.85	9.53	6.97	0.92	9.05	6.75	0.99	8.48	6.50	1.07
64.4	77.0	12.38	8.42	0.58	11.43	7.99	0.72	10.48	7.58	0.86	10.00	7.37	0.92	9.52	7.17	0.99	8.95	6.93	1.08
67.0	80.0	12.62	8.84	0.58	11.67	8.43	0.72	10.71	8.03	0.86	10.20	7.83	0.93	9.76	7.64	1.00	9.19	7.41	1.08
71.6	86.0	13.33	8.49	0.59	12.37	8.13	0.73	11.42	7.77	0.86	10.94	7.60	0.93	10.47	7.43	1.00	9.89	7.22	1.08
75.2	89.6	13.80	8.24	0.59	12.84	7.91	0.73	11.89	7.59	0.87	11.41	7.43	0.94	10.94	7.27	1.01	10.37	7.09	1.09

**Heating (60 Hz, 208 V)**

AFR	9.4
-----	-----

Temp: Celsius / TC, PI: kW

INDOOR		OUTDOOR TEMPERATURE (°CWB)															
EDB		-25		-20		-15		-10		-5		0		6		15.5	
°C		TC	PI	TC	PI	TC	PI	TC	PI	TC	PI	TC	PI	TC	PI	TC	PI
15.0		2.58	1.62	3.33	1.65	4.05	1.69	4.31	1.65	4.57	1.61	4.84	1.58	5.17	1.53	5.70	1.65
21.1		2.31	1.67	3.07	1.70	3.80	1.74	4.09	1.70	4.37	1.65	4.66	1.61	5.00	1.56	5.54	1.69
22.0		2.17	1.64	2.95	1.70	3.70	1.76	4.00	1.71	4.29	1.67	4.58	1.63	4.93	1.58	5.48	1.70
24.0		1.83	1.37	2.61	1.49	3.37	1.59	3.91	1.73	4.21	1.69	4.51	1.64	4.86	1.59	5.27	1.64
25.0		1.66	1.24	2.44	1.39	3.20	1.50	3.86	1.74	4.17	1.70	4.47	1.65	4.83	1.60	5.10	1.57
27.0		1.32	0.97	2.10	1.18	2.86	1.33	3.54	1.58	4.09	1.71	4.40	1.67	4.76	1.61	4.76	1.45

Temp: Fahrenheit / TC: kBtu/h / PI: kW

INDOOR		OUTDOOR TEMPERATURE (°FWB)															
EDB		-13		-4		5		14		23		32		43		60	
°F		TC	PI	TC	PI	TC	PI	TC	PI	TC	PI	TC	PI	TC	PI	TC	PI
59.0		8.82	1.62	11.39	1.65	13.85	1.69	14.73	1.65	15.64	1.61	16.56	1.58	17.69	1.53	19.49	1.65
70.0		7.91	1.67	10.51	1.70	13.00	1.74	13.98	1.70	14.95	1.65	15.93	1.61	17.10	1.56	18.95	1.69
71.6		7.39	1.64	10.05	1.70	12.64	1.76	13.67	1.71	14.68	1.67	15.67	1.63	16.86	1.58	18.74	1.70
75.2		6.23	1.37	8.89	1.49	11.48	1.59	13.37	1.73	14.40	1.69	15.42	1.64	16.63	1.59	17.98	1.64
77.0		5.65	1.24	8.31	1.39	10.90	1.50	13.22	1.74	14.27	1.70	15.29	1.65	16.51	1.60	17.40	1.57
80.6		4.49	0.97	7.15	1.18	9.74	1.33	12.06	1.58	13.99	1.71	15.04	1.67	16.24	1.61	16.24	1.45

**Cooling (60 Hz, 230 V)**

AFR	8.5
BF	0.11

Temp: Celsius / TC, SHC, PI: kW

INDOOR		OUTDOOR TEMPERATURE (°CDB)																	
EWB	EDB	10			20			30			35			40			46		
°C	°C	TC	SHC	PI	TC	SHC	PI	TC	SHC	PI	TC	SHC	PI	TC	SHC	PI	TC	SHC	PI
14.0	20.0	3.35	2.42	0.57	3.07	2.28	0.71	2.79	2.14	0.85	2.65	2.07	0.92	2.51	2.00	0.99	2.35	1.92	1.07
16.0	22.0	3.49	2.37	0.58	3.21	2.24	0.72	2.93	2.11	0.85	2.79	2.04	0.92	2.65	1.98	0.99	2.49	1.90	1.07
18.0	25.0	3.63	2.47	0.58	3.35	2.34	0.72	3.07	2.22	0.86	2.93	2.16	0.92	2.79	2.10	0.99	2.62	2.03	1.08
19.4	26.7	3.70	2.59	0.58	3.42	2.47	0.72	3.14	2.35	0.86	3.00	2.29	0.93	2.86	2.24	1.00	2.69	2.17	1.08
22.0	30.0	3.91	2.49	0.59	3.63	2.38	0.73	3.35	2.28	0.86	3.21	2.23	0.93	3.07	2.18	1.00	2.90	2.12	1.08
24.0	32.0	4.04	2.42	0.59	3.76	2.32	0.73	3.49	2.22	0.87	3.35	2.18	0.94	3.21	2.13	1.01	3.04	2.08	1.09

Temp: Fahrenheit / TC, SHC: kBtu/h / PI: kW

INDOOR		OUTDOOR TEMPERATURE (°FDB)																	
EWB	EDB	50			68			86			95			104			115		
°F	°F	TC	SHC	PI	TC	SHC	PI	TC	SHC	PI	TC	SHC	PI	TC	SHC	PI	TC	SHC	PI
57.2	68.0	11.44	8.26	0.57	10.49	7.77	0.71	9.53	7.29	0.85	9.06	7.06	0.92	8.58	6.83	0.99	8.01	6.56	1.07
60.8	71.6	11.91	8.09	0.58	10.96	7.63	0.72	10.01	7.19	0.85	9.53	6.97	0.92	9.05	6.75	0.99	8.48	6.50	1.07
64.4	77.0	12.38	8.42	0.58	11.43	7.99	0.72	10.48	7.58	0.86	10.00	7.37	0.92	9.52	7.17	0.99	8.95	6.93	1.08
67.0	80.0	12.62	8.84	0.58	11.67	8.43	0.72	10.71	8.03	0.86	10.20	7.83	0.93	9.76	7.64	1.00	9.19	7.41	1.08
71.6	86.0	13.33	8.49	0.59	12.37	8.13	0.73	11.42	7.77	0.86	10.94	7.60	0.93	10.47	7.43	1.00	9.89	7.22	1.08
75.2	89.6	13.80	8.24	0.59	12.84	7.91	0.73	11.89	7.59	0.87	11.41	7.43	0.94	10.94	7.27	1.01	10.37	7.09	1.09

**Heating (60 Hz, 230 V)**

AFR	9.4
-----	-----

Temp: Celsius / TC, PI: kW

INDOOR		OUTDOOR TEMPERATURE (°CWB)															
EDB		-25		-20		-15		-10		-5		0		6		15.5	
°C		TC	PI	TC	PI	TC	PI	TC	PI	TC	PI	TC	PI	TC	PI	TC	PI
15.0		2.58	1.62	3.33	1.65	4.05	1.69	4.31	1.65	4.57	1.61	4.84	1.58	5.17	1.53	5.70	1.65
21.1		2.31	1.67	3.07	1.70	3.80	1.74	4.09	1.70	4.37	1.65	4.66	1.61	5.00	1.56	5.54	1.69
22.0		2.17	1.64	2.95	1.70	3.70	1.76	4.00	1.71	4.29	1.67	4.58	1.63	4.93	1.58	5.48	1.70
24.0		1.83	1.37	2.61	1.49	3.37	1.59	3.91	1.73	4.21	1.69	4.51	1.64	4.86	1.59	5.27	1.64
25.0		1.66	1.24	2.44	1.39	3.20	1.50	3.86	1.74	4.17	1.70	4.47	1.65	4.83	1.60	5.10	1.57
27.0		1.32	0.97	2.10	1.18	2.86	1.33	3.54	1.58	4.09	1.71	4.40	1.67	4.76	1.61	4.76	1.45

Temp: Fahrenheit / TC: kBtu/h / PI: kW

INDOOR		OUTDOOR TEMPERATURE (°FWB)															
EDB		-13		-4		5		14		23		32		43		60	
°F		TC	PI	TC	PI	TC	PI	TC	PI	TC	PI	TC	PI	TC	PI	TC	PI
59.0		8.82	1.62	11.39	1.65	13.85	1.69	14.73	1.65	15.64	1.61	16.56	1.58	17.69	1.53	19.49	1.65
70.0		7.91	1.67	10.51	1.70	13.00	1.74	13.98	1.70	14.95	1.65	15.93	1.61	17.10	1.56	18.95	1.69
71.6		7.39	1.64	10.05	1.70	12.64	1.76	13.67	1.71	14.68	1.67	15.67	1.63	16.86	1.58	18.74	1.70
75.2		6.23	1.37	8.89	1.49	11.48	1.59	13.37	1.73	14.40	1.69	15.42	1.64	16.63	1.59	17.98	1.64
77.0		5.65	1.24	8.31	1.39	10.90	1.50	13.22	1.74	14.27	1.70	15.29	1.65	16.51	1.60	17.40	1.57
80.6		4.49	0.97	7.15	1.18	9.74	1.33	12.06	1.58	13.99	1.71	15.04	1.67	16.24	1.61	16.24	1.45

**Symbols:**

- AFR : Airflow rate (m³/min.)
- BF : Bypass factor
- EWB : Entering wet bulb temp. (°C) / (°F)
- EDB : Entering dry bulb temp. (°C) / (°F)
- TC : Total capacity (kW) / (kBtu/h)
- SHC : Sensible heat capacity (kW) / (kBtu/h)
- PI : Power input (kW)

**Notes:**

1.  shows nominal (rated) capacities and power input (Cooling) and MAX capacities and power input (Heating).
2. TC, PI and SHC must be calculated by interpolation using the figures in the above tables. (Figures out of the tables should not be used for calculation.)
3. Capacities are based on the following conditions.  
Corresponding refrigerant piping length : 25 ft (7.5 m)  
Level difference : 0 ft (0 m)
4. Airflow rate (AFR) and Bypass factor (BF) are tabulated above table.

### FVXS15WVJU9 + RXL15WMVJU9

**Cooling (60 Hz, 208 V)**

AFR	10.7
BF	0.13

Temp: Celsius / TC, SHC, PI: kW

INDOOR		OUTDOOR TEMPERATURE (°CDB)																	
EWB	EDB	10			20			30			35			40			46		
°C	°C	TC	SHC	PI	TC	SHC	PI	TC	SHC	PI	TC	SHC	PI	TC	SHC	PI	TC	SHC	PI
14.0	20.0	4.53	3.19	0.81	4.51	3.18	1.00	4.10	2.96	1.19	3.89	2.86	1.29	3.69	2.75	1.39	3.44	2.63	1.50
16.0	22.0	5.12	3.33	0.81	4.71	3.12	1.01	4.30	2.92	1.20	4.10	2.82	1.30	3.89	2.72	1.39	3.65	2.61	1.51
18.0	25.0	5.32	3.44	0.82	4.91	3.24	1.01	4.50	3.05	1.20	4.30	2.96	1.30	4.09	2.87	1.40	3.85	2.76	1.51
19.4	26.7	5.42	3.58	0.82	5.01	3.39	1.01	4.60	3.21	1.21	4.40	3.12	1.30	4.20	3.03	1.40	3.95	2.93	1.52
22.0	30.0	5.73	3.43	0.83	5.32	3.26	1.02	4.91	3.10	1.22	4.70	3.02	1.31	4.50	2.94	1.41	4.25	2.85	1.52
24.0	32.0	5.93	3.32	0.84	5.52	3.17	1.03	5.11	3.02	1.22	4.91	2.95	1.32	4.70	2.88	1.41	4.46	2.79	1.53

Temp: Fahrenheit / TC, SHC: kBtu/h / PI: kW

INDOOR		OUTDOOR TEMPERATURE (°FDB)																	
EWB	EDB	50			68			86			95			104			115		
°F	°F	TC	SHC	PI	TC	SHC	PI	TC	SHC	PI	TC	SHC	PI	TC	SHC	PI	TC	SHC	PI
57.2	68.0	15.46	10.89	0.81	15.38	10.85	1.00	13.98	10.11	1.19	13.28	9.75	1.29	12.58	9.40	1.39	11.75	8.98	1.50
60.8	71.6	17.47	11.37	0.81	16.07	10.65	1.01	14.67	9.96	1.20	13.98	9.63	1.30	13.28	9.29	1.39	12.44	8.90	1.51
64.4	77.0	18.16	11.73	0.82	16.76	11.06	1.01	15.37	10.42	1.20	14.67	10.10	1.30	13.97	9.79	1.40	13.13	9.43	1.51
67.0	80.0	18.51	12.22	0.82	17.11	11.58	1.01	15.71	10.96	1.21	15.00	10.65	1.30	15.00	10.35	1.40	13.47	10.00	1.52
71.6	86.0	19.55	11.70	0.83	18.15	11.13	1.02	16.75	10.58	1.22	16.05	10.31	1.31	15.35	10.05	1.41	14.51	9.73	1.52
75.2	89.6	20.24	11.33	0.84	18.84	10.81	1.03	17.44	10.31	1.22	16.74	10.06	1.32	16.04	9.82	1.41	15.20	9.53	1.53

**Heating (60 Hz, 208 V)**

AFR	11.8
-----	------

Temp: Celsius / TC, PI: kW

INDOOR		OUTDOOR TEMPERATURE (°CWB)															
EDB		-25		-20		-15		-10		-5		2		6		15.5	
°C		TC	PI	TC	PI	TC	PI	TC	PI	TC	PI	TC	PI	TC	PI	TC	PI
15.0		3.58	2.05	4.63	2.09	5.63	2.14	6.00	2.05	6.38	1.96	6.93	1.84	7.24	1.77	8.32	1.76
21.1		3.21	2.11	4.27	2.15	5.28	2.20	5.69	2.11	6.10	2.01	6.67	1.88	7.00	1.81	7.26	1.50
22.0		3.07	2.14	4.13	2.17	5.14	2.22	5.57	2.13	5.99	2.03	6.57	1.90	6.83	1.79	6.83	1.40
24.0		2.68	1.85	3.98	2.20	5.00	2.25	5.44	2.15	5.87	2.05	6.40	1.88	6.40	1.66	6.40	1.30
25.0		2.46	1.69	3.86	2.16	4.91	2.24	5.38	2.16	5.82	2.06	6.19	1.81	6.19	1.60	6.19	1.25
27.0		2.04	1.38	3.43	1.89	4.48	2.02	5.01	2.00	5.55	1.98	5.76	1.66	5.76	1.47	5.76	1.15

Temp: Fahrenheit / TC: kBtu/h / PI: kW

INDOOR		OUTDOOR TEMPERATURE (°FWB)															
EDB		-13		-4		5		14		23		36		43		60	
°F		TC	PI	TC	PI	TC	PI	TC	PI	TC	PI	TC	PI	TC	PI	TC	PI
59.0		12.22	2.05	15.77	2.09	19.18	2.14	20.48	2.05	21.82	1.96	23.72	1.84	24.83	1.77	28.40	1.76
70.0		10.96	2.11	14.55	2.15	18.00	2.20	19.43	2.11	20.86	2.01	22.86	1.88	24.00	1.81	24.75	1.50
71.6		10.45	2.14	14.06	2.17	17.53	2.22	19.01	2.13	20.47	2.03	22.51	1.90	23.30	1.79	23.30	1.40
75.2		9.13	1.85	13.58	2.20	17.05	2.25	18.59	2.15	20.09	2.05	21.84	1.88	21.84	1.66	21.84	1.30
77.0		8.40	1.69	13.16	2.16	16.75	2.24	18.38	2.16	19.90	2.06	21.11	1.81	21.11	1.60	21.11	1.25
80.6		6.94	1.38	11.71	1.89	15.29	2.02	17.11	2.00	18.93	1.98	19.66	1.66	19.66	1.47	19.66	1.15

**Cooling (60 Hz, 230 V)**

AFR	10.7
BF	0.13

Temp: Celsius / TC, SHC, PI: kW

INDOOR		OUTDOOR TEMPERATURE (°CDB)																	
EWB	EDB	10			20			30			35			40			46		
°C	°C	TC	SHC	PI	TC	SHC	PI	TC	SHC	PI	TC	SHC	PI	TC	SHC	PI	TC	SHC	PI
14.0	20.0	4.53	3.19	0.81	4.51	3.18	1.00	4.10	2.96	1.19	3.89	2.86	1.29	3.69	2.75	1.39	3.44	2.63	1.50
16.0	22.0	5.12	3.33	0.81	4.71	3.12	1.01	4.30	2.92	1.20	4.10	2.82	1.30	3.89	2.72	1.39	3.65	2.61	1.51
18.0	25.0	5.32	3.44	0.82	4.91	3.24	1.01	4.50	3.05	1.20	4.30	2.96	1.30	4.09	2.87	1.40	3.85	2.76	1.51
19.4	26.7	5.42	3.58	0.82	5.01	3.39	1.01	4.60	3.21	1.21	4.40	3.12	1.30	4.20	3.03	1.40	3.95	2.93	1.52
22.0	30.0	5.73	3.43	0.83	5.32	3.26	1.02	4.91	3.10	1.22	4.70	3.02	1.31	4.50	2.94	1.41	4.25	2.85	1.52
24.0	32.0	5.93	3.32	0.84	5.52	3.17	1.03	5.11	3.02	1.22	4.91	2.95	1.32	4.70	2.88	1.41	4.46	2.79	1.53

Temp: Fahrenheit / TC, SHC: kBtu/h / PI: kW

INDOOR		OUTDOOR TEMPERATURE (°FDB)																	
EWB	EDB	50			68			86			95			104			115		
°F	°F	TC	SHC	PI	TC	SHC	PI	TC	SHC	PI	TC	SHC	PI	TC	SHC	PI	TC	SHC	PI
57.2	68.0	15.46	10.89	0.81	15.38	10.85	1.00	13.98	10.11	1.19	13.28	9.75	1.29	12.58	9.40	1.39	11.75	8.98	1.50
60.8	71.6	17.47	11.37	0.81	16.07	10.65	1.01	14.67	9.96	1.20	13.98	9.63	1.30	13.28	9.29	1.39	12.44	8.90	1.51
64.4	77.0	18.16	11.73	0.82	16.76	11.06	1.01	15.37	10.42	1.20	14.67	10.10	1.30	13.97	9.79	1.40	13.13	9.43	1.51
67.0	80.0	18.51	12.22	0.82	17.11	11.58	1.01	15.71	10.96	1.21	15.00	10.65	1.30	15.00	10.35	1.40	13.47	10.00	1.52
71.6	86.0	19.55	11.70	0.83	18.15	11.13	1.02	16.75	10.58	1.22	16.05	10.31	1.31	15.35	10.05	1.41	14.51	9.73	1.52
75.2	89.6	20.24	11.33	0.84	18.84	10.81	1.03	17.44	10.31	1.22	16.74	10.06	1.32	16.04	9.82	1.41	15.20	9.53	1.53

**Heating (60 Hz, 230 V)**

AFR	11.8
-----	------

Temp: Celsius / TC, PI: kW

INDOOR		OUTDOOR TEMPERATURE (°CWB)															
EDB		-25		-20		-15		-10		-5		2		6		15.5	
°C		TC	PI	TC	PI	TC	PI	TC	PI	TC	PI	TC	PI	TC	PI	TC	PI
15.0		3.58	2.05	4.63	2.09	5.63	2.14	6.00	2.05	6.38	1.96	6.93	1.84	7.24	1.77	8.32	1.76
21.1		3.21	2.11	4.27	2.15	5.28	2.20	5.69	2.11	6.10	2.01	6.67	1.88	7.00	1.81	7.26	1.50
22.0		3.07	2.14	4.13	2.17	5.14	2.22	5.57	2.13	5.99	2.03	6.57	1.90	6.83	1.79	6.83	1.40
24.0		2.68	1.85	3.98	2.20	5.00	2.25	5.44	2.15	5.87	2.05	6.40	1.88	6.40	1.66	6.40	1.30
25.0		2.46	1.69	3.86	2.16	4.91	2.24	5.38	2.16	5.82	2.06	6.19	1.81	6.19	1.60	6.19	1.25
27.0		2.04	1.38	3.43	1.89	4.48	2.02	5.01	2.00	5.55	1.98	5.76	1.66	5.76	1.47	5.76	1.15

Temp: Fahrenheit / TC: kBtu/h / PI: kW

INDOOR		OUTDOOR TEMPERATURE (°FWB)															
EDB		-13		-4		5		14		23		36		43		60	
°F		TC	PI	TC	PI	TC	PI	TC	PI	TC	PI	TC	PI	TC	PI	TC	PI
59.0		12.22	2.05	15.77	2.09	19.18	2.14	20.48	2.05	21.82	1.96	23.72	1.84	24.83	1.77	28.40	1.76
70.0		10.96	2.11	14.55	2.15	18.00	2.20	19.43	2.11	20.86	2.01	22.86	1.88	24.00	1.81	24.75	1.50
71.6		10.45	2.14	14.06	2.17	17.53	2.22	19.01	2.13	20.47	2.03	22.51	1.90	23.30	1.79	23.30	1.40
75.2		9.13	1.85	13.58	2.20	17.05	2.25	18.59	2.15	20.09	2.05	21.84	1.88	21.84	1.66	21.84	1.30
77.0		8.40	1.69	13.16	2.16	16.75	2.24	18.38	2.16	19.90	2.06	21.11	1.81	21.11	1.60	21.11	1.25
80.6		6.94	1.38	11.71	1.89	15.29	2.02	17.11	2.00	18.93	1.98	19.66	1.66	19.66	1.47	19.66	1.15

**Symbols:**

- AFR : Airflow rate (m³/min.)
- BF : Bypass factor
- EWB : Entering wet bulb temp. (°C) / (°F)
- EDB : Entering dry bulb temp. (°C) / (°F)
- TC : Total capacity (kW) / (kBtu/h)
- SHC : Sensible heat capacity (kW) / (kBtu/h)
- PI : Power input (kW)

**Notes:**

1.  shows nominal (rated) capacities and power input (Cooling) and MAX capacities and power input (Heating).
2. TC, PI and SHC must be calculated by interpolation using the figures in the above tables. (Figures out of the tables should not be used for calculation.)
3. Capacities are based on the following conditions.  
Corresponding refrigerant piping length : 25 ft (7.5 m)  
Level difference : 0 ft (0 m)
4. Airflow rate (AFR) and Bypass factor (BF) are tabulated above table.

### FDMQ12WVJU9 + RXL12WMVJU9

**Cooling (60 Hz, 208 V)**

AFR	7.8
BF	0.17

Temp: Celsius / TC, SHC, PI: kW

INDOOR		OUTDOOR TEMPERATURE (°CDB)																	
EWB	EDB	10			20			30			35			40			46		
°C	°C	TC	SHC	PI	TC	SHC	PI	TC	SHC	PI	TC	SHC	PI	TC	SHC	PI	TC	SHC	PI
14.0	20.0	3.14	2.21	0.63	3.14	2.21	0.88	2.95	2.11	1.11	2.80	2.03	1.20	2.65	1.96	1.29	2.48	1.87	1.40
16.0	22.0	3.68	2.38	0.76	3.39	2.23	0.94	3.09	2.08	1.12	2.95	2.01	1.21	2.80	1.94	1.30	2.62	1.85	1.40
18.0	25.0	3.83	2.45	0.76	3.53	2.31	0.94	3.24	2.17	1.12	3.09	2.10	1.21	2.94	2.04	1.30	2.77	1.96	1.41
19.4	26.7	3.90	2.55	0.76	3.61	2.41	0.94	3.31	2.28	1.12	3.17	2.21	1.21	3.02	2.15	1.30	2.84	2.07	1.41
22.0	30.0	4.12	2.44	0.77	3.83	2.32	0.95	3.53	2.20	1.13	3.38	2.14	1.22	3.24	2.08	1.31	3.06	2.02	1.42
24.0	32.0	4.27	2.36	0.78	3.97	2.25	0.96	3.68	2.14	1.14	3.53	2.09	1.23	3.38	2.04	1.32	3.21	1.97	1.42

Temp: Fahrenheit / TC, SHC: kBtu/h / PI: kW

INDOOR		OUTDOOR TEMPERATURE (°FDB)																	
EWB	EDB	50			68			86			95			104			115		
°F	°F	TC	SHC	PI	TC	SHC	PI	TC	SHC	PI	TC	SHC	PI	TC	SHC	PI	TC	SHC	PI
57.2	68.0	10.70	7.54	0.63	10.70	7.54	0.88	10.06	7.20	1.11	9.56	6.94	1.20	9.05	6.68	1.29	8.45	6.37	1.40
60.8	71.6	12.57	8.12	0.76	11.56	7.60	0.94	10.56	7.09	1.12	10.05	6.85	1.21	9.55	6.60	1.30	8.95	6.32	1.40
64.4	77.0	13.07	8.36	0.76	12.06	7.87	0.94	11.05	7.40	1.12	10.55	7.17	1.21	10.05	6.95	1.30	9.44	6.68	1.41
67.0	80.0	13.31	8.70	0.76	12.31	8.23	0.94	11.30	7.77	1.12	10.80	7.55	1.21	10.30	7.33	1.30	9.69	7.07	1.41
71.6	86.0	14.06	8.32	0.77	13.06	7.91	0.95	12.05	7.50	1.13	11.55	7.31	1.22	11.04	7.11	1.31	10.44	6.88	1.42
75.2	89.6	14.56	8.05	0.78	13.55	7.67	0.96	12.55	7.30	1.14	12.04	7.12	1.23	11.54	6.95	1.32	10.94	6.74	1.42

**Heating (60 Hz, 208 V)**

AFR	10.8
-----	------

Temp: Celsius / TC, PI: kW

INDOOR		OUTDOOR TEMPERATURE (°CWB)																	
EDB		-25		-20		-15		-10		-5		0		6		15.5			
°C		TC	PI	TC	PI	TC	PI	TC	PI	TC	PI	TC	PI	TC	PI	TC	PI		
15.0		2.86	1.58	3.37	1.78	3.90	1.98	4.19	1.99	4.49	2.00	4.79	2.01	5.15	2.02	6.22	2.19		
21.1		2.56	1.63	3.11	1.83	3.66	2.04	3.98	2.04	4.29	2.05	4.61	2.06	4.98	2.07	6.05	2.23		
22.0		2.45	1.65	3.01	1.85	3.57	2.06	3.89	2.07	4.21	2.07	4.53	2.08	4.91	2.09	5.98	2.25		
24.0		2.33	1.67	2.91	1.87	3.47	2.08	3.81	2.09	4.13	2.09	4.46	2.10	4.84	2.11	5.91	2.27		
25.0		2.19	1.57	2.85	1.88	3.42	2.09	3.76	2.10	4.09	2.10	4.42	2.11	4.81	2.12	5.88	2.28		
27.0		1.77	1.24	2.75	1.91	3.33	2.11	3.68	2.12	4.02	2.12	4.35	2.13	4.74	2.14	5.56	2.11		

Temp: Fahrenheit / TC: kBtu/h / PI: kW

INDOOR		OUTDOOR TEMPERATURE (°FWB)																	
EDB		-13		-4		5		14		23		32		43		60			
°F		TC	PI	TC	PI	TC	PI	TC	PI	TC	PI	TC	PI	TC	PI	TC	PI		
59.0		9.76	1.58	11.51	1.78	13.32	1.98	14.30	1.99	15.32	2.00	16.34	2.01	17.59	2.02	21.23	2.19		
70.0		8.75	1.63	10.63	1.83	12.50	2.04	13.57	2.04	14.64	2.05	15.71	2.06	17.00	2.07	20.65	2.23		
71.6		8.35	1.65	10.27	1.85	12.17	2.06	13.28	2.07	14.37	2.07	15.46	2.08	16.77	2.09	20.41	2.25		
75.2		7.94	1.67	9.91	1.87	11.84	2.08	12.98	2.09	14.10	2.09	15.21	2.10	16.53	2.11	20.18	2.27		
77.0		7.46	1.57	9.74	1.88	11.68	2.09	12.84	2.10	13.97	2.10	15.09	2.11	16.41	2.12	20.06	2.28		
80.6		6.06	1.24	9.38	1.91	11.35	2.11	12.54	2.12	13.70	2.12	14.84	2.13	16.18	2.14	18.96	2.11		

**Cooling (60 Hz, 230 V)**

AFR	7.8
BF	0.17

Temp: Celsius / TC, SHC, PI: kW

INDOOR		OUTDOOR TEMPERATURE (°CDB)																	
EWB	EDB	10			20			30			35			40			46		
°C	°C	TC	SHC	PI	TC	SHC	PI	TC	SHC	PI	TC	SHC	PI	TC	SHC	PI	TC	SHC	PI
14.0	20.0	3.14	2.21	0.63	3.14	2.21	0.88	2.95	2.11	1.11	2.80	2.03	1.20	2.65	1.96	1.29	2.48	1.87	1.40
16.0	22.0	3.68	2.38	0.76	3.39	2.23	0.94	3.09	2.08	1.12	2.95	2.01	1.21	2.80	1.94	1.30	2.62	1.85	1.40
18.0	25.0	3.83	2.45	0.76	3.53	2.31	0.94	3.24	2.17	1.12	3.09	2.10	1.21	2.94	2.04	1.30	2.77	1.96	1.41
19.4	26.7	3.90	2.55	0.76	3.61	2.41	0.94	3.31	2.28	1.12	3.17	2.21	1.21	3.02	2.15	1.30	2.84	2.07	1.41
22.0	30.0	4.12	2.44	0.77	3.83	2.32	0.95	3.53	2.20	1.13	3.38	2.14	1.22	3.24	2.08	1.31	3.06	2.02	1.42
24.0	32.0	4.27	2.36	0.78	3.97	2.25	0.96	3.68	2.14	1.14	3.53	2.09	1.23	3.38	2.04	1.32	3.21	1.97	1.42

Temp: Fahrenheit / TC, SHC: kBtu/h / PI: kW

INDOOR		OUTDOOR TEMPERATURE (°FDB)																	
EWB	EDB	50			68			86			95			104			115		
°F	°F	TC	SHC	PI	TC	SHC	PI	TC	SHC	PI	TC	SHC	PI	TC	SHC	PI	TC	SHC	PI
57.2	68.0	10.70	7.54	0.63	10.70	7.54	0.88	10.06	7.20	1.11	9.56	6.94	1.20	9.05	6.68	1.29	8.45	6.37	1.40
60.8	71.6	12.57	8.12	0.76	11.56	7.60	0.94	10.56	7.09	1.12	10.05	6.85	1.21	9.55	6.60	1.30	8.95	6.32	1.40
64.4	77.0	13.07	8.36	0.76	12.06	7.87	0.94	11.05	7.40	1.12	10.55	7.17	1.21	10.05	6.95	1.30	9.44	6.68	1.41
67.0	80.0	13.31	8.70	0.76	12.31	8.23	0.94	11.30	7.77	1.12	10.80	7.55	1.21	10.30	7.33	1.30	9.69	7.07	1.41
71.6	86.0	14.06	8.32	0.77	13.06	7.91	0.95	12.05	7.50	1.13	11.55	7.31	1.22	11.04	7.11	1.31	10.44	6.88	1.42
75.2	89.6	14.56	8.05	0.78	13.55	7.67	0.96	12.55	7.30	1.14	12.04	7.12	1.23	11.54	6.95	1.32	10.94	6.74	1.42

**Heating (60 Hz, 230 V)**

AFR	10.8
-----	------

Temp: Celsius / TC, PI: kW

INDOOR		OUTDOOR TEMPERATURE (°CWB)															
EDB		-25		-20		-15		-10		-5		0		6		15.5	
°C		TC	PI	TC	PI	TC	PI	TC	PI	TC	PI	TC	PI	TC	PI	TC	PI
15.0		2.86	1.58	3.37	1.78	3.90	1.98	4.19	1.99	4.49	2.00	4.79	2.01	5.15	2.02	6.22	2.19
21.1		2.56	1.63	3.11	1.83	3.66	2.04	3.98	2.04	4.29	2.05	4.61	2.06	4.98	2.07	6.05	2.23
22.0		2.45	1.65	3.01	1.85	3.57	2.06	3.89	2.07	4.21	2.07	4.53	2.08	4.91	2.09	5.98	2.25
24.0		2.33	1.67	2.91	1.87	3.47	2.08	3.81	2.09	4.13	2.09	4.46	2.10	4.84	2.11	5.91	2.27
25.0		2.19	1.57	2.85	1.88	3.42	2.09	3.76	2.10	4.09	2.10	4.42	2.11	4.81	2.12	5.88	2.28
27.0		1.77	1.24	2.75	1.91	3.33	2.11	3.68	2.12	4.02	2.12	4.35	2.13	4.74	2.14	5.56	2.11

Temp: Fahrenheit / TC: kBtu/h / PI: kW

INDOOR		OUTDOOR TEMPERATURE (°FWB)															
EDB		-13		-4		5		14		23		32		43		60	
°F		TC	PI	TC	PI	TC	PI	TC	PI	TC	PI	TC	PI	TC	PI	TC	PI
59.0		9.76	1.58	11.51	1.78	13.32	1.98	14.30	1.99	15.32	2.00	16.34	2.01	17.59	2.02	21.23	2.19
70.0		8.75	1.63	10.63	1.83	12.50	2.04	13.57	2.04	14.64	2.05	15.71	2.06	17.00	2.07	20.65	2.23
71.6		8.35	1.65	10.27	1.85	12.17	2.06	13.28	2.07	14.37	2.07	15.46	2.08	16.77	2.09	20.41	2.25
75.2		7.94	1.67	9.91	1.87	11.84	2.08	12.98	2.09	14.10	2.09	15.21	2.10	16.53	2.11	20.18	2.27
77.0		7.46	1.57	9.74	1.88	11.68	2.09	12.84	2.10	13.97	2.10	15.09	2.11	16.41	2.12	20.06	2.28
80.6		6.06	1.24	9.38	1.91	11.35	2.11	12.54	2.12	13.70	2.12	14.84	2.13	16.18	2.14	18.96	2.11

**Symbols:**

- AFR : Airflow rate (m³/min.)
- BF : Bypass factor
- EWB : Entering wet bulb temp. (°C) / (°F)
- EDB : Entering dry bulb temp. (°C) / (°F)
- TC : Total capacity (kW) / (kBtu/h)
- SHC : Sensible heat capacity (kW) / (kBtu/h)
- PI : Power input (kW)

**Notes:**

1. ■ shows nominal (rated) capacities and power input (Cooling) and MAX capacities and power input (Heating).
2. TC, PI and SHC must be calculated by interpolation using the figures in the above tables. (Figures out of the tables should not be used for calculation.)
3. Capacities are based on the following conditions.  
Corresponding refrigerant piping length : 25 ft (7.5 m)  
Level difference : 0 ft (0 m)
4. Airflow rate (AFR) and Bypass factor (BF) are tabulated above table.

**FDMQ18WVJU9 + RXL18WMVJU9**

**Cooling (60 Hz, 208 V)**

AFR	12.3
BF	0.21

Temp: Celsius / TC, SHC, PI: kW

INDOOR		OUTDOOR TEMPERATURE (°CDB)																	
EWB	EDB	10			20			30			35			40			46		
°C	°C	TC	SHC	PI	TC	SHC	PI	TC	SHC	PI	TC	SHC	PI	TC	SHC	PI	TC	SHC	PI
14.0	20.0	4.72	3.32	0.78	4.72	3.32	1.09	4.72	3.32	1.55	4.56	3.24	1.74	4.32	3.11	1.87	4.04	2.97	2.03
16.0	22.0	5.79	3.71	1.03	5.52	3.57	1.36	5.04	3.32	1.62	4.80	3.20	1.75	4.56	3.08	1.88	4.27	2.94	2.03
18.0	25.0	6.24	3.92	1.11	5.76	3.68	1.37	5.28	3.45	1.63	5.04	3.34	1.76	4.80	3.23	1.89	4.51	3.10	2.04
19.4	26.7	6.36	4.07	1.11	5.88	3.84	1.37	5.40	3.61	1.63	5.16	3.50	1.76	4.92	3.40	1.89	4.63	3.27	2.05
22.0	30.0	6.72	3.89	1.12	6.24	3.68	1.38	5.75	3.48	1.64	5.51	3.39	1.77	5.27	3.29	1.90	4.99	3.18	2.06
24.0	32.0	6.95	3.76	1.13	6.47	3.57	1.39	5.99	3.39	1.65	5.75	3.30	1.78	5.51	3.21	1.91	5.22	3.11	2.07

Temp: Fahrenheit / TC, SHC: kBtu/h / PI: kW

INDOOR		OUTDOOR TEMPERATURE (°FDB)																	
EWB	EDB	50			68			86			95			104			115		
°F	°F	TC	SHC	PI	TC	SHC	PI	TC	SHC	PI	TC	SHC	PI	TC	SHC	PI	TC	SHC	PI
57.2	68.0	16.09	11.33	0.78	16.09	11.33	1.09	16.09	11.33	1.55	15.57	11.06	1.74	14.75	10.63	1.87	13.77	10.12	2.03
60.8	71.6	19.76	12.66	1.03	18.84	12.17	1.36	17.20	11.33	1.62	16.38	10.92	1.75	15.56	10.51	1.88	14.58	10.03	2.03
64.4	77.0	21.29	13.39	1.11	19.65	12.57	1.37	18.01	11.78	1.63	17.19	11.40	1.76	16.38	11.02	1.89	15.39	10.57	2.04
67.0	80.0	21.70	13.88	1.11	20.06	13.09	1.37	18.42	12.33	1.63	17.60	11.96	1.76	16.78	11.59	1.89	15.80	11.16	2.05
71.6	86.0	22.91	13.27	1.12	21.27	12.57	1.38	19.64	11.89	1.64	18.82	11.56	1.77	18.00	11.23	1.90	17.01	10.85	2.06
75.2	89.6	23.72	12.82	1.13	22.09	12.18	1.39	20.45	11.56	1.65	19.63	11.26	1.78	18.81	10.96	1.91	17.82	10.61	2.07

**Heating (60 Hz, 208 V)**

AFR	17.7
-----	------

Temp: Celsius / TC, PI: kW

INDOOR		OUTDOOR TEMPERATURE (°CWB)																	
EDB		-25		-20		-15		-10		-5		0		6		15.5			
°C		TC	PI	TC	PI	TC	PI	TC	PI	TC	PI	TC	PI	TC	PI	TC	PI		
15.0		4.94	2.73	5.83	3.07	6.75	3.42	6.92	3.22	7.12	3.02	7.32	2.81	7.58	2.57	9.15	2.77		
21.1		4.43	2.81	5.38	3.17	6.33	3.52	6.57	3.31	6.81	3.09	7.04	2.88	7.33	2.63	8.90	2.83		
22.0		4.00	2.61	5.20	3.20	6.16	3.56	6.43	3.34	6.68	3.12	6.93	2.91	7.23	2.65	8.80	2.86		
24.0		3.32	2.13	4.88	3.08	6.00	3.59	6.28	3.37	6.56	3.15	6.82	2.94	7.12	2.68	8.70	2.88		
25.0		2.98	1.90	4.54	2.83	5.91	3.61	6.21	3.39	6.49	3.17	6.76	2.95	7.07	2.69	8.65	2.89		
27.0		2.30	1.45	3.86	2.35	5.64	3.52	6.07	3.43	6.37	3.20	6.65	2.98	6.97	2.71	8.54	2.92		

Temp: Fahrenheit / TC: kBtu/h / PI: kW

INDOOR		OUTDOOR TEMPERATURE (°FWB)																	
EDB		-13		-4		5		14		23		32		43		60			
°F		TC	PI	TC	PI	TC	PI	TC	PI	TC	PI	TC	PI	TC	PI	TC	PI		
59.0		16.86	2.73	19.90	3.07	23.02	3.42	23.62	3.22	24.29	3.02	24.99	2.81	25.86	2.57	31.23	2.77		
70.0		15.12	2.81	18.36	3.17	21.60	3.52	22.41	3.31	23.22	3.09	24.03	2.88	25.00	2.63	30.36	2.83		
71.6		13.65	2.61	17.75	3.20	21.03	3.56	21.93	3.34	22.79	3.12	23.64	2.91	24.65	2.65	30.02	2.86		
75.2		11.33	2.13	16.65	3.08	20.47	3.59	21.44	3.37	22.37	3.15	23.26	2.94	24.31	2.68	29.67	2.88		
77.0		10.17	1.90	15.49	2.83	20.18	3.61	21.20	3.39	22.15	3.17	23.07	2.95	24.14	2.69	29.50	2.89		
80.6		7.84	1.45	13.17	2.35	19.23	3.52	20.71	3.43	21.73	3.20	22.69	2.98	23.79	2.71	29.16	2.92		



**Cooling (60 Hz, 230 V)**

AFR	12.3
BF	0.21

Temp: Celsius / TC, SHC, PI: kW

INDOOR		OUTDOOR TEMPERATURE (°CDB)																	
EWB	EDB	10			20			30			35			40			46		
°C	°C	TC	SHC	PI	TC	SHC	PI	TC	SHC	PI	TC	SHC	PI	TC	SHC	PI	TC	SHC	PI
14.0	20.0	4.72	3.32	0.78	4.72	3.32	1.09	4.72	3.32	1.55	4.56	3.24	1.74	4.32	3.11	1.87	4.04	2.97	2.03
16.0	22.0	5.79	3.71	1.03	5.52	3.57	1.36	5.04	3.32	1.62	4.80	3.20	1.75	4.56	3.08	1.88	4.27	2.94	2.03
18.0	25.0	6.24	3.92	1.11	5.76	3.68	1.37	5.28	3.45	1.63	5.04	3.34	1.76	4.80	3.23	1.89	4.51	3.10	2.04
19.4	26.7	6.36	4.07	1.11	5.88	3.84	1.37	5.40	3.61	1.63	5.16	3.50	1.76	4.92	3.40	1.89	4.63	3.27	2.05
22.0	30.0	6.72	3.89	1.12	6.24	3.68	1.38	5.75	3.48	1.64	5.51	3.39	1.77	5.27	3.29	1.90	4.99	3.18	2.06
24.0	32.0	6.95	3.76	1.13	6.47	3.57	1.39	5.99	3.39	1.65	5.75	3.30	1.78	5.51	3.21	1.91	5.22	3.11	2.07

Temp: Fahrenheit / TC, SHC: kBtu/h / PI: kW

INDOOR		OUTDOOR TEMPERATURE (°FDB)																	
EWB	EDB	50			68			86			95			104			115		
°F	°F	TC	SHC	PI	TC	SHC	PI	TC	SHC	PI	TC	SHC	PI	TC	SHC	PI	TC	SHC	PI
57.2	68.0	16.09	11.33	0.78	16.09	11.33	1.09	16.09	11.33	1.55	15.57	11.06	1.74	14.75	10.63	1.87	13.77	10.12	2.03
60.8	71.6	19.76	12.66	1.03	18.84	12.17	1.36	17.20	11.33	1.62	16.38	10.92	1.75	15.56	10.51	1.88	14.58	10.03	2.03
64.4	77.0	21.29	13.39	1.11	19.65	12.57	1.37	18.01	11.78	1.63	17.19	11.40	1.76	16.38	11.02	1.89	15.39	10.57	2.04
67.0	80.0	21.70	13.88	1.11	20.06	13.09	1.37	18.42	12.33	1.63	17.60	11.96	1.76	16.78	11.59	1.89	15.80	11.16	2.05
71.6	86.0	22.91	13.27	1.12	21.27	12.57	1.38	19.64	11.89	1.64	18.82	11.56	1.77	18.00	11.23	1.90	17.01	10.85	2.06
75.2	89.6	23.72	12.82	1.13	22.09	12.18	1.39	20.45	11.56	1.65	19.63	11.26	1.78	18.81	10.96	1.91	17.82	10.61	2.07

**Heating (60 Hz, 230 V)**

AFR	17.7
-----	------

Temp: Celsius / TC, PI: kW

INDOOR		OUTDOOR TEMPERATURE (°CWB)															
EDB		-25		-20		-15		-10		-5		0		6		15.5	
°C		TC	PI	TC	PI	TC	PI	TC	PI	TC	PI	TC	PI	TC	PI	TC	PI
15.0		4.94	2.73	5.83	3.07	6.75	3.42	6.92	3.22	7.12	3.02	7.32	2.81	7.58	2.57	9.15	2.77
21.1		4.43	2.81	5.38	3.17	6.33	3.52	6.57	3.31	6.81	3.09	7.04	2.88	7.33	2.63	8.90	2.83
22.0		4.00	2.61	5.20	3.20	6.16	3.56	6.43	3.34	6.68	3.12	6.93	2.91	7.23	2.65	8.80	2.86
24.0		3.32	2.13	4.88	3.08	6.00	3.59	6.28	3.37	6.56	3.15	6.82	2.94	7.12	2.68	8.70	2.88
25.0		2.98	1.90	4.54	2.83	5.91	3.61	6.21	3.39	6.49	3.17	6.76	2.95	7.07	2.69	8.65	2.89
27.0		2.30	1.45	3.86	2.35	5.64	3.52	6.07	3.43	6.37	3.20	6.65	2.98	6.97	2.71	8.54	2.92

Temp: Fahrenheit / TC: kBtu/h / PI: kW

INDOOR		OUTDOOR TEMPERATURE (°FWB)															
EDB		-13		-4		5		14		23		32		43		60	
°F		TC	PI	TC	PI	TC	PI	TC	PI	TC	PI	TC	PI	TC	PI	TC	PI
59.0		16.86	2.73	19.90	3.07	23.02	3.42	23.62	3.22	24.29	3.02	24.99	2.81	25.86	2.57	31.23	2.77
70.0		15.12	2.81	18.36	3.17	21.60	3.52	22.41	3.31	23.22	3.09	24.03	2.88	25.00	2.63	30.36	2.83
71.6		13.65	2.61	17.75	3.20	21.03	3.56	21.93	3.34	22.79	3.12	23.64	2.91	24.65	2.65	30.02	2.86
75.2		11.33	2.13	16.65	3.08	20.47	3.59	21.44	3.37	22.37	3.15	23.26	2.94	24.31	2.68	29.67	2.88
77.0		10.17	1.90	15.49	2.83	20.18	3.61	21.20	3.39	22.15	3.17	23.07	2.95	24.14	2.69	29.50	2.89
80.6		7.84	1.45	13.17	2.35	19.23	3.52	20.71	3.43	21.73	3.20	22.69	2.98	23.79	2.71	29.16	2.92

**Symbols:**

- AFR : Airflow rate (m³/min.)
- BF : Bypass factor
- EWB : Entering wet bulb temp. (°C) / (°F)
- EDB : Entering dry bulb temp. (°C) / (°F)
- TC : Total capacity (kW) / (kBtu/h)
- SHC : Sensible heat capacity (kW) / (kBtu/h)
- PI : Power input (kW)

**Notes:**

1. ■ shows nominal (rated) capacities and power input (Cooling) and MAX capacities and power input (Heating).
2. TC, PI and SHC must be calculated by interpolation using the figures in the above tables. (Figures out of the tables should not be used for calculation.)
3. Capacities are based on the following conditions.  
Corresponding refrigerant piping length : 25 ft (7.5 m)  
Level difference : 0 ft (0 m)
4. Airflow rate (AFR) and Bypass factor (BF) are tabulated above table.

### FDMQ24WVJU9 + RXL24WMVJU9

**Cooling (60 Hz, 208 V)**

AFR	15.1
BF	0.24

Temp: Celsius / TC, SHC, PI: kW

INDOOR		OUTDOOR TEMPERATURE (°CDB)																	
EWB	EDB	10			20			30			35			40			46		
°C	°C	TC	SHC	PI	TC	SHC	PI	TC	SHC	PI	TC	SHC	PI	TC	SHC	PI	TC	SHC	PI
14.0	20.0	5.59	3.94	0.99	5.59	3.94	1.37	5.59	3.94	1.90	5.50	3.89	2.18	5.21	3.74	2.35	4.86	3.56	2.54
16.0	22.0	6.87	4.40	1.27	6.65	4.29	1.70	6.07	3.99	2.03	5.78	3.84	2.19	5.49	3.70	2.36	5.15	3.53	2.55
18.0	25.0	7.52	4.71	1.39	6.94	4.42	1.71	6.36	4.14	2.04	6.07	4.00	2.20	5.78	3.87	2.37	5.43	3.71	2.56
19.4	26.7	7.66	4.88	1.39	7.08	4.60	1.72	6.50	4.33	2.05	6.21	4.20	2.21	5.92	4.07	2.37	5.58	3.92	2.57
22.0	30.0	8.09	4.67	1.41	7.51	4.42	1.73	6.93	4.18	2.06	6.64	4.06	2.22	6.35	3.94	2.39	6.01	3.81	2.58
24.0	32.0	8.38	4.51	1.42	7.80	4.28	1.74	7.22	4.06	2.07	6.93	3.95	2.23	6.64	3.85	2.40	6.29	3.72	2.59

Temp: Fahrenheit / TC, SHC: kBtu/h / PI: kW

INDOOR		OUTDOOR TEMPERATURE (°FDB)																	
EWB	EDB	50			68			86			95			104			115		
°F	°F	TC	SHC	PI	TC	SHC	PI	TC	SHC	PI	TC	SHC	PI	TC	SHC	PI	TC	SHC	PI
57.2	68.0	19.09	13.44	0.99	19.09	13.44	1.37	19.09	13.44	1.90	18.76	13.27	2.18	17.77	12.75	2.35	16.59	12.13	2.54
60.8	71.6	23.44	15.02	1.27	22.70	14.62	1.70	20.72	13.60	2.03	19.73	13.10	2.19	18.75	12.61	2.36	17.56	12.03	2.55
64.4	77.0	25.65	16.08	1.39	23.67	15.09	1.71	21.70	14.13	2.04	20.71	13.67	2.20	19.72	13.21	2.37	18.54	12.67	2.56
67.0	80.0	26.14	16.66	1.39	24.16	15.70	1.72	22.19	14.78	2.05	21.20	14.33	2.21	20.21	13.88	2.37	19.03	13.36	2.57
71.6	86.0	27.60	15.92	1.41	25.63	15.07	1.73	23.65	14.25	2.06	22.67	13.85	2.22	21.68	13.45	2.39	20.49	12.99	2.58
75.2	89.6	28.58	15.38	1.42	26.60	14.60	1.74	24.63	13.85	2.07	23.64	13.48	2.23	22.65	13.12	2.40	21.47	12.70	2.59

**Heating (60 Hz, 208 V)**

AFR	21.0
-----	------

Temp: Celsius / TC, PI: kW

INDOOR		OUTDOOR TEMPERATURE (°CWB)																	
EDB		-25		-20		-15		-10		-5		0		6		15.5			
°C		TC	PI	TC	PI	TC	PI	TC	PI	TC	PI	TC	PI	TC	PI	TC	PI		
15.0		5.26	2.91	6.21	3.27	7.18	3.64	7.44	3.49	7.72	3.33	8.01	3.17	8.37	2.98	10.10	3.22		
21.1		4.72	3.00	5.73	3.37	6.74	3.74	7.06	3.58	7.38	3.41	7.70	3.25	8.09	3.05	9.82	3.29		
22.0		4.50	3.03	5.54	3.41	6.56	3.79	6.91	3.62	7.25	3.45	7.58	3.28	7.98	3.08	9.71	3.32		
24.0		3.84	2.55	5.35	3.45	6.39	3.83	6.76	3.65	7.11	3.48	7.46	3.31	7.87	3.11	9.60	3.34		
25.0		3.45	2.25	5.25	3.47	6.30	3.85	6.68	3.67	7.04	3.50	7.40	3.33	7.81	3.12	9.55	3.36		
27.0		2.66	1.67	4.47	2.81	6.12	3.89	6.53	3.71	6.91	3.53	7.27	3.36	7.70	3.15	9.43	3.38		

Temp: Fahrenheit / TC: kBtu/h / PI: kW

INDOOR		OUTDOOR TEMPERATURE (°FWB)																	
EDB		-13		-4		5		14		23		32		43		60			
°F		TC	PI	TC	PI	TC	PI	TC	PI	TC	PI	TC	PI	TC	PI	TC	PI		
59.0		17.95	2.91	21.18	3.27	24.51	3.64	25.40	3.49	26.35	3.33	27.34	3.17	28.55	2.98	34.47	3.22		
70.0		16.10	3.00	19.55	3.37	23.00	3.74	24.10	3.58	25.19	3.41	26.29	3.25	27.60	3.05	33.52	3.29		
71.6		15.36	3.03	18.90	3.41	22.40	3.79	23.57	3.62	24.73	3.45	25.87	3.28	27.22	3.08	33.14	3.32		
75.2		13.12	2.55	18.24	3.45	21.79	3.83	23.05	3.65	24.26	3.48	25.45	3.31	26.84	3.11	32.76	3.34		
77.0		11.77	2.25	17.92	3.47	21.49	3.85	22.79	3.67	24.03	3.50	25.24	3.33	26.65	3.12	32.57	3.36		
80.6		9.08	1.67	15.25	2.81	20.89	3.89	22.27	3.71	23.57	3.53	24.82	3.36	26.27	3.15	32.19	3.38		

**Cooling (60 Hz, 230 V)**

AFR	15.1
BF	0.24

Temp: Celsius / TC, SHC, PI: kW

INDOOR		OUTDOOR TEMPERATURE (°CDB)																	
EWB	EDB	10			20			30			35			40			46		
°C	°C	TC	SHC	PI	TC	SHC	PI	TC	SHC	PI	TC	SHC	PI	TC	SHC	PI	TC	SHC	PI
14.0	20.0	5.59	3.94	0.99	5.59	3.94	1.37	5.59	3.94	1.90	5.50	3.89	2.18	5.21	3.74	2.35	4.86	3.56	2.54
16.0	22.0	6.87	4.40	1.27	6.65	4.29	1.70	6.07	3.99	2.03	5.78	3.84	2.19	5.49	3.70	2.36	5.15	3.53	2.55
18.0	25.0	7.52	4.71	1.39	6.94	4.42	1.71	6.36	4.14	2.04	6.07	4.00	2.20	5.78	3.87	2.37	5.43	3.71	2.56
19.4	26.7	7.66	4.88	1.39	7.08	4.60	1.72	6.50	4.33	2.05	6.21	4.20	2.21	5.92	4.07	2.37	5.58	3.92	2.57
22.0	30.0	8.09	4.67	1.41	7.51	4.42	1.73	6.93	4.18	2.06	6.64	4.06	2.22	6.35	3.94	2.39	6.01	3.81	2.58
24.0	32.0	8.38	4.51	1.42	7.80	4.28	1.74	7.22	4.06	2.07	6.93	3.95	2.23	6.64	3.85	2.40	6.29	3.72	2.59

Temp: Fahrenheit / TC, SHC: kBtu/h / PI: kW

INDOOR		OUTDOOR TEMPERATURE (°FDB)																	
EWB	EDB	50			68			86			95			104			115		
°F	°F	TC	SHC	PI	TC	SHC	PI	TC	SHC	PI	TC	SHC	PI	TC	SHC	PI	TC	SHC	PI
57.2	68.0	19.09	13.44	0.99	19.09	13.44	1.37	19.09	13.44	1.90	18.76	13.27	2.18	17.77	12.75	2.35	16.59	12.13	2.54
60.8	71.6	23.44	15.02	1.27	22.70	14.62	1.70	20.72	13.60	2.03	19.73	13.10	2.19	18.75	12.61	2.36	17.56	12.03	2.55
64.4	77.0	25.65	16.08	1.39	23.67	15.09	1.71	21.70	14.13	2.04	20.71	13.67	2.20	19.72	13.21	2.37	18.54	12.67	2.56
67.0	80.0	26.14	16.66	1.39	24.16	15.70	1.72	22.19	14.78	2.05	21.20	14.33	2.21	20.21	13.88	2.37	19.03	13.36	2.57
71.6	86.0	27.60	15.92	1.41	25.63	15.07	1.73	23.65	14.25	2.06	22.67	13.85	2.22	21.68	13.45	2.39	20.49	12.99	2.58
75.2	89.6	28.58	15.38	1.42	26.60	14.60	1.74	24.63	13.85	2.07	23.64	13.48	2.23	22.65	13.12	2.40	21.47	12.70	2.59

**Heating (60 Hz, 230 V)**

AFR	21.0
-----	------

Temp: Celsius / TC, PI: kW

INDOOR		OUTDOOR TEMPERATURE (°CWB)															
EDB		-25		-20		-15		-10		-5		0		6		15.5	
°C		TC	PI	TC	PI	TC	PI	TC	PI	TC	PI	TC	PI	TC	PI	TC	PI
15.0		5.26	2.91	6.21	3.27	7.18	3.64	7.44	3.49	7.72	3.33	8.01	3.17	8.37	2.98	10.10	3.22
21.1		4.72	3.00	5.73	3.37	6.74	3.74	7.06	3.58	7.38	3.41	7.70	3.25	8.09	3.05	9.82	3.29
22.0		4.50	3.03	5.54	3.41	6.56	3.79	6.91	3.62	7.25	3.45	7.58	3.28	7.98	3.08	9.71	3.32
24.0		3.84	2.55	5.35	3.45	6.39	3.83	6.76	3.65	7.11	3.48	7.46	3.31	7.87	3.11	9.60	3.34
25.0		3.45	2.25	5.25	3.47	6.30	3.85	6.68	3.67	7.04	3.50	7.40	3.33	7.81	3.12	9.55	3.36
27.0		2.66	1.67	4.47	2.81	6.12	3.89	6.53	3.71	6.91	3.53	7.27	3.36	7.70	3.15	9.43	3.38

Temp: Fahrenheit / TC: kBtu/h / PI: kW

INDOOR		OUTDOOR TEMPERATURE (°FWB)															
EDB		-13		-4		5		14		23		32		43		60	
°F		TC	PI	TC	PI	TC	PI	TC	PI	TC	PI	TC	PI	TC	PI	TC	PI
59.0		17.95	2.91	21.18	3.27	24.51	3.64	25.40	3.49	26.35	3.33	27.34	3.17	28.55	2.98	34.47	3.22
70.0		16.10	3.00	19.55	3.37	23.00	3.74	24.10	3.58	25.19	3.41	26.29	3.25	27.60	3.05	33.52	3.29
71.6		15.36	3.03	18.90	3.41	22.40	3.79	23.57	3.62	24.73	3.45	25.87	3.28	27.22	3.08	33.14	3.32
75.2		13.12	2.55	18.24	3.45	21.79	3.83	23.05	3.65	24.26	3.48	25.45	3.31	26.84	3.11	32.76	3.34
77.0		11.77	2.25	17.92	3.47	21.49	3.85	22.79	3.67	24.03	3.50	25.24	3.33	26.65	3.12	32.57	3.36
80.6		9.08	1.67	15.25	2.81	20.89	3.89	22.27	3.71	23.57	3.53	24.82	3.36	26.27	3.15	32.19	3.38

**Symbols:**

- AFR : Airflow rate (m³/min.)
- BF : Bypass factor
- EWB : Entering wet bulb temp. (°C) / (°F)
- EDB : Entering dry bulb temp. (°C) / (°F)
- TC : Total capacity (kW) / (kBtu/h)
- SHC : Sensible heat capacity (kW) / (kBtu/h)
- PI : Power input (kW)

**Notes:**

1. ■ shows nominal (rated) capacities and power input (Cooling) and MAX capacities and power input (Heating).
2. TC, PI and SHC must be calculated by interpolation using the figures in the above tables. (Figures out of the tables should not be used for calculation.)
3. Capacities are based on the following conditions.  
Corresponding refrigerant piping length : 25 ft (7.5 m)  
Level difference : 0 ft (0 m)
4. Airflow rate (AFR) and Bypass factor (BF) are tabulated above table.

## 7.1 Capacity Correction Factor by the Length of Refrigerant Piping (Reference)

The cooling capacity and the heating capacity of the unit have to be corrected in accordance with the length of refrigerant piping — the distance between the indoor unit and the outdoor unit.

### 7.1.1 09/12 Class

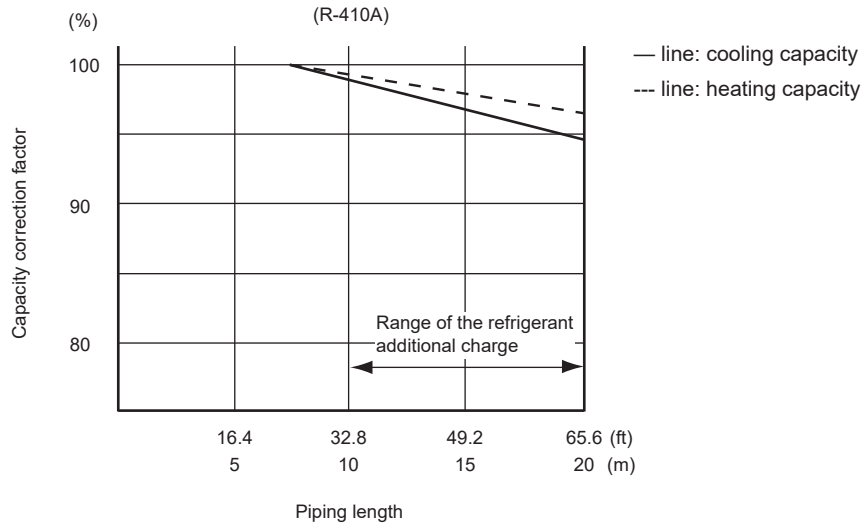

### 7.1.2 15/18 Class

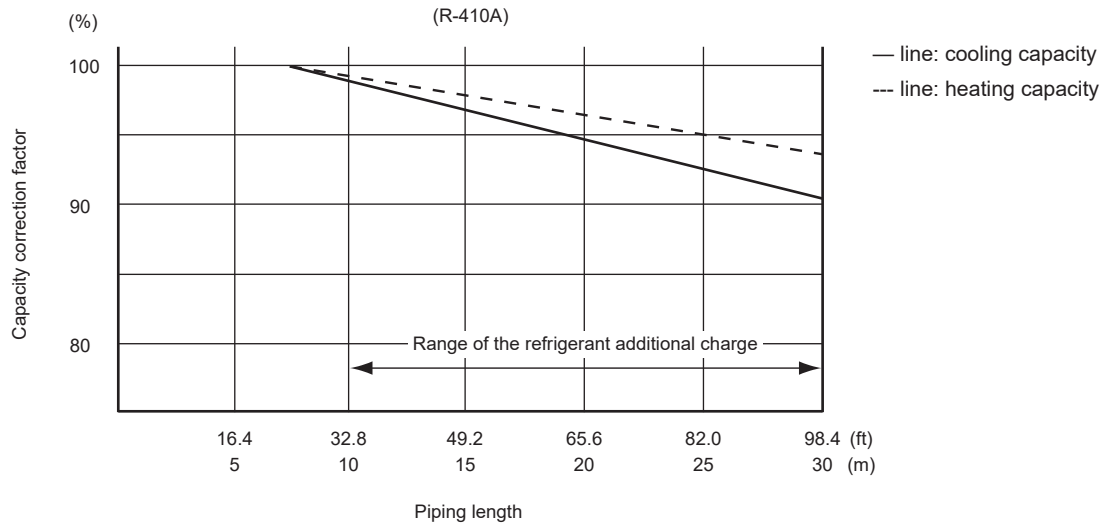

7.1.3 24 Class

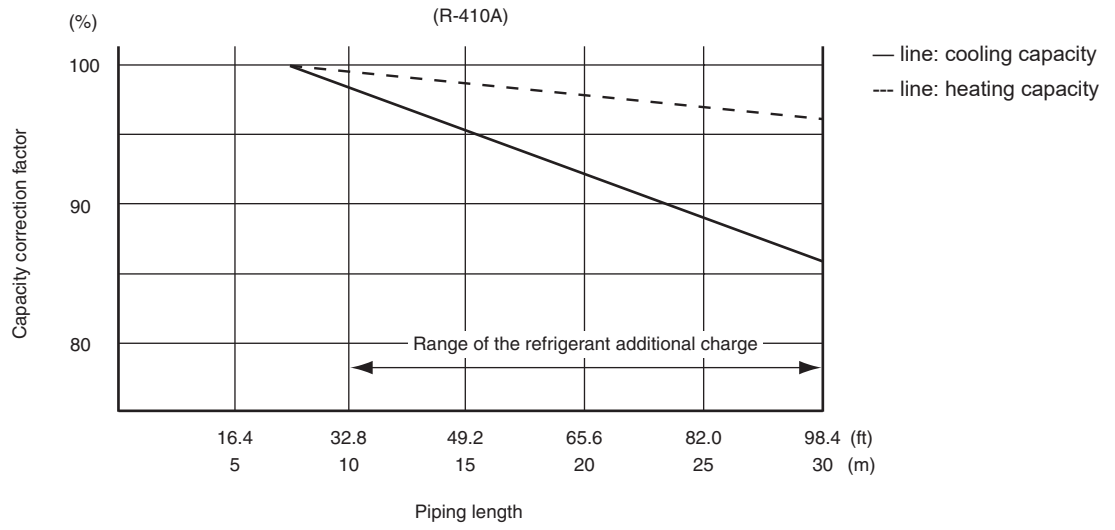

**Note:** The graphs show the factor when additional refrigerant of the proper quantity is charged.

# 8. Operation Limit

## RXL09/15WMVJU9

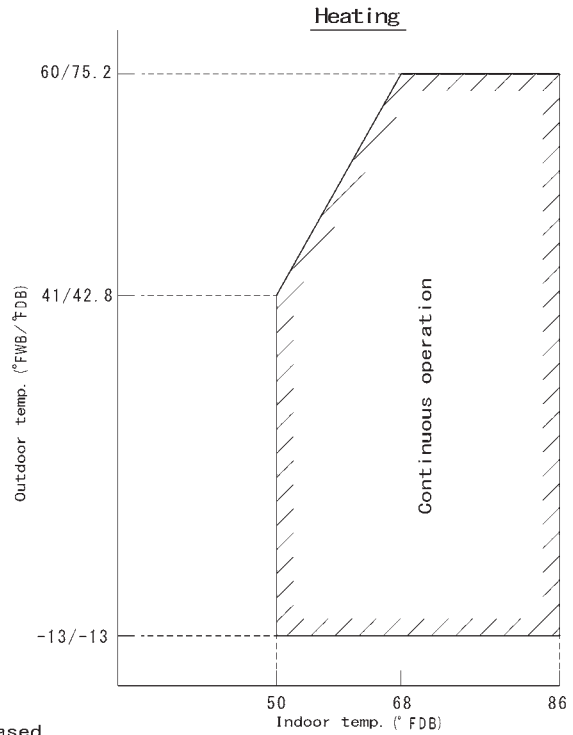
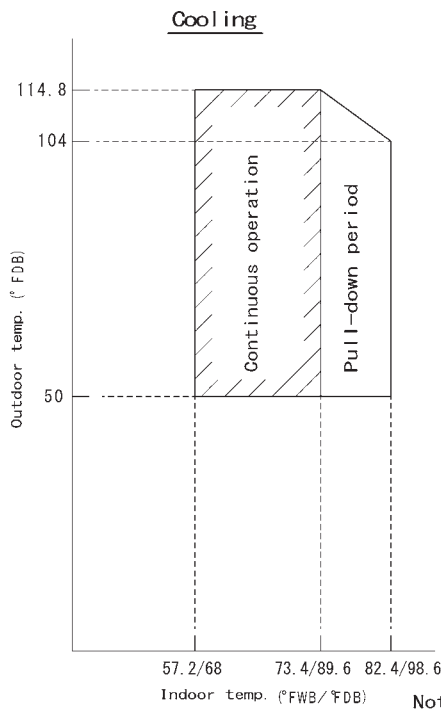

Notes:  
 The graphs are based on the following conditions.  
 • Equivalent piping length 25ft  
 • Level difference 0ft  
 • Air flow rate High

3D100732A

## RXL12/18/24WMVJU9

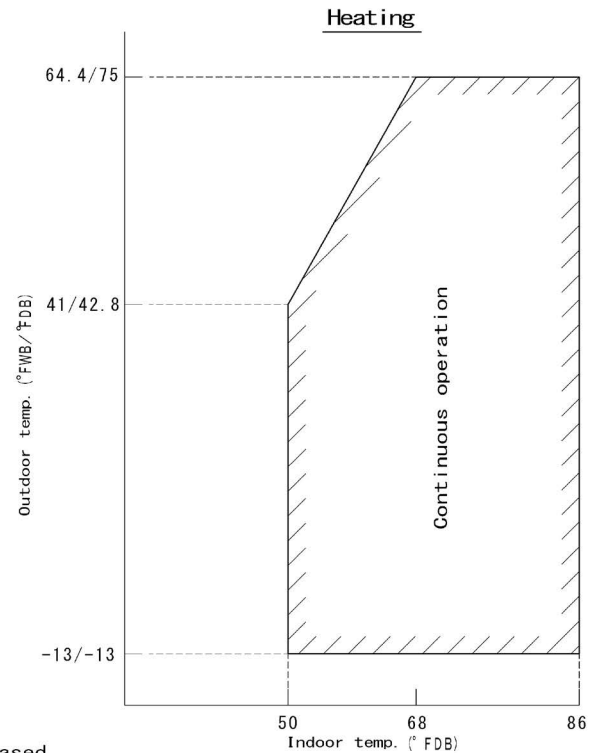
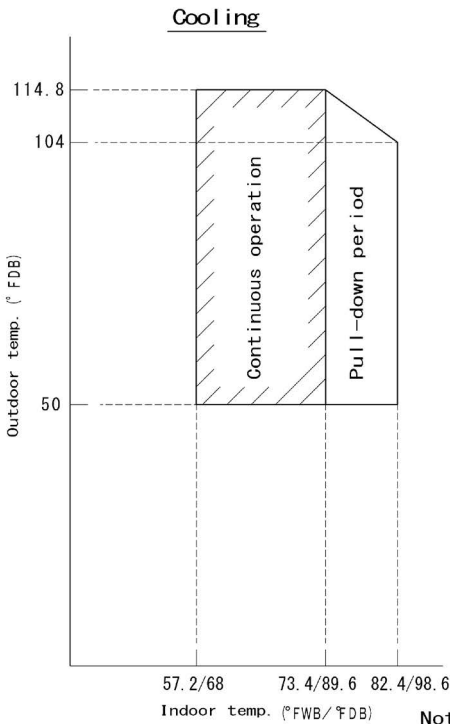

Notes:  
 The graphs are based on the following conditions.  
 • Equivalent piping length 25ft  
 • Level difference 0ft  
 • Air flow rate High

3D123451

# 9. Fan Characteristics

## 9.1 External Static Pressure

### FDMQ12WVJU9

Fan characteristics ①

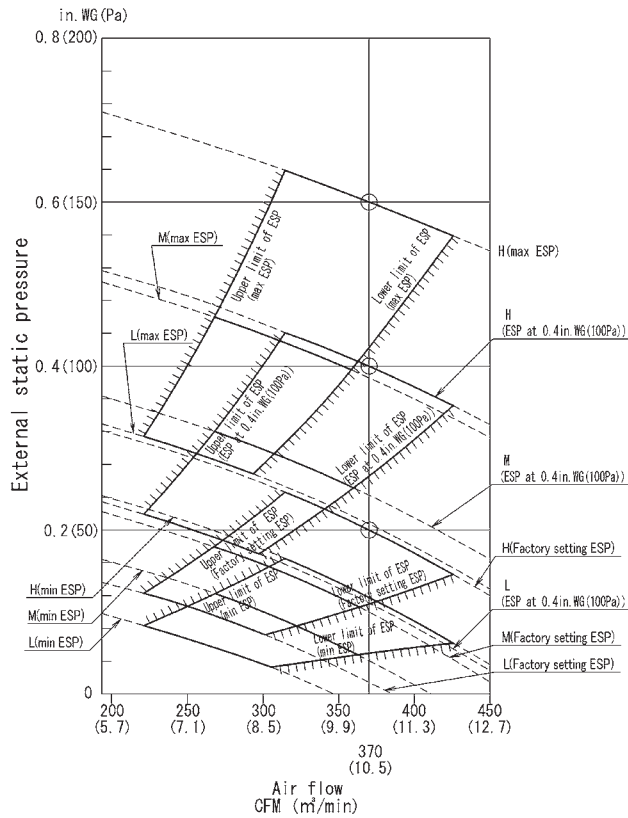

Fan characteristics ②  
(For field setting of remote controller)

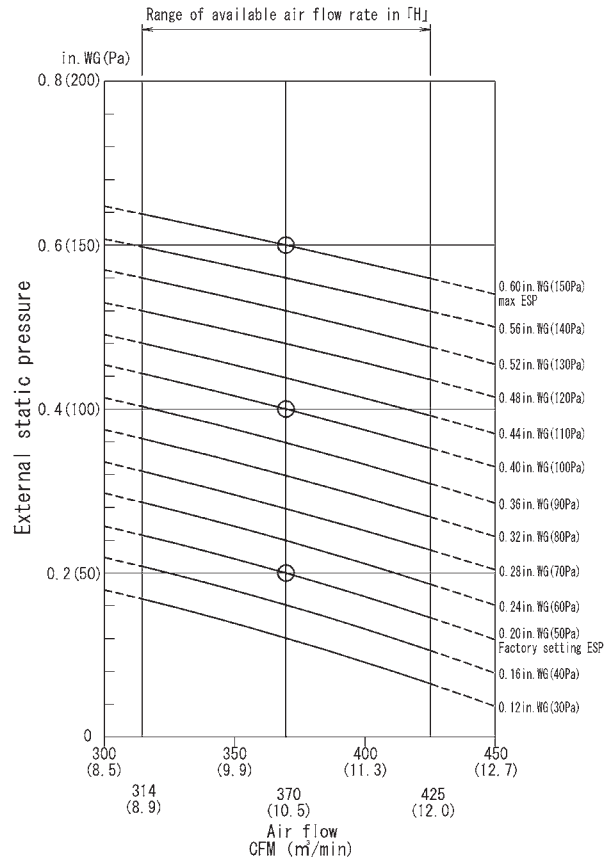

Notes:

1. Fan characteristics at the time of rear suction and bottom suction are similar to each other.
2. Fan characteristics① shows a representative of fan characteristics at the time of "Maximum ESP", "ESP at 0.4in. WG (100Pa)", "Factory setting ESP" and "Minimum ESP".
3. A remote controller can be used to change airflow rate of "H", "M" and "L".
4. Set the ESP on suction side to 0.4in. WG (100Pa) or less.
5. Fan characteristics② (for field setting of remote controller) shows fan characteristics of airflow "H" which can be changed in the field setting by a remote controller.
6. Select ESP setting in accordance with resistance of the connected duct by using Fan characteristics① and ② (Factory setting ESP is 0.2in. WG (50Pa). See installation manual for ESP setting procedure.)
7. The ESP setting of this unit can be changed into 13 levels.
8. The value of Fan characteristics② mentioned in this drawing shows the ESP of rated airflow.

ESP : external static pressure

FDMQ18WVJU9

Fan characteristics ①

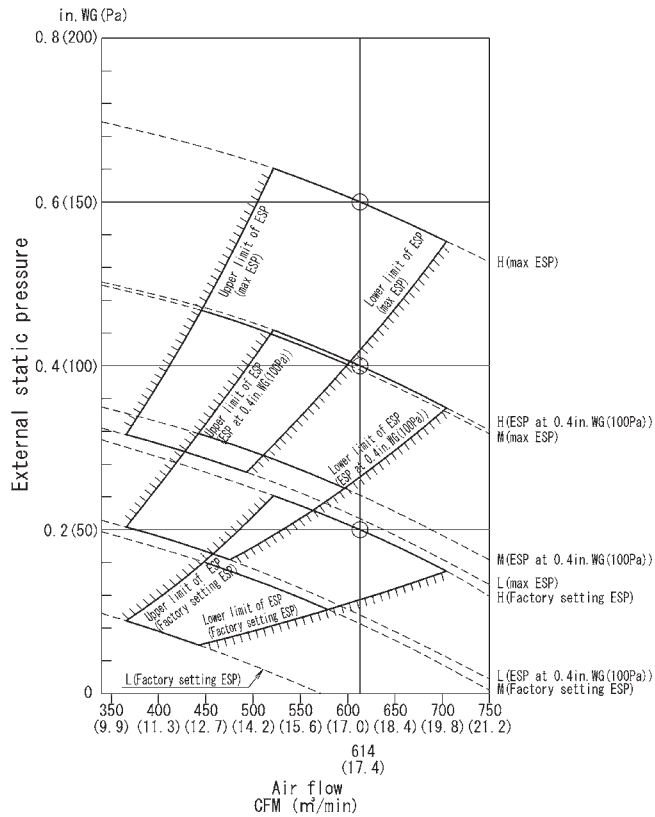

Fan characteristics ②  
(For field setting of remote controller)

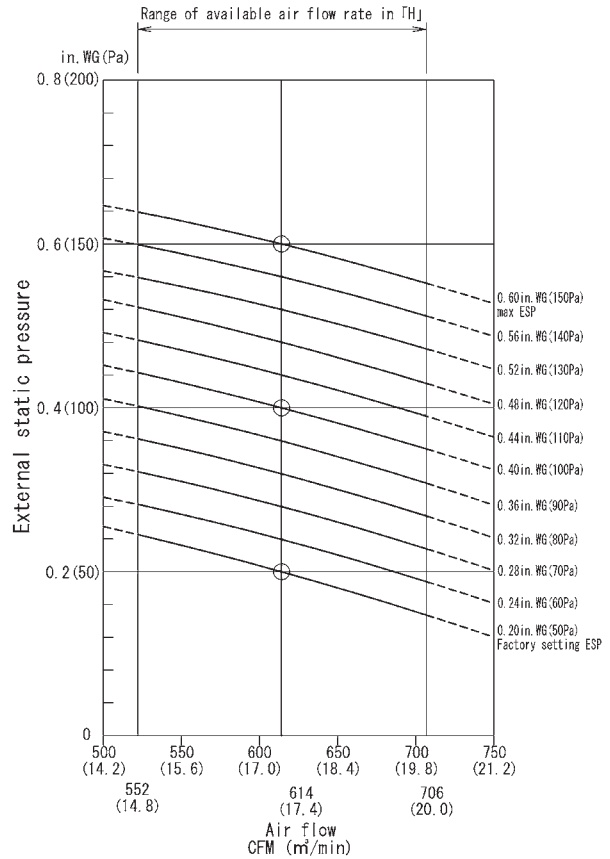

Notes:

1. Fan characteristics at the time of rear suction and bottom suction are similar to each other.
2. Fan characteristics ① shows a representative of fan characteristics at the time of "Maximum ESP", "ESP at 0.4in. WG (100Pa)" and "Factory setting ESP".
3. A remote controller can be used to change air flow rate of "H", "M" and "L".
4. Set the ESP on suction side to 0.4in. WG (100Pa) or less.
5. Fan characteristics ② (for field setting of remote controller) shows fan characteristics of air flow "H" which can be changed in the field setting by a remote controller.
6. Select ESP setting in accordance with resistance of the connected duct by using Fan characteristics ① and ② (Factory setting ESP is 0.2in. WG (50Pa). See installation manual for ESP setting procedure.)
7. The ESP setting of this unit can be changed into 10 levels.
8. The value of Fan characteristics ② mentioned in this drawing shows the ESP of rated airflow.

ESP : external static pressure



FDMQ24WVJU9

Fan characteristics ①

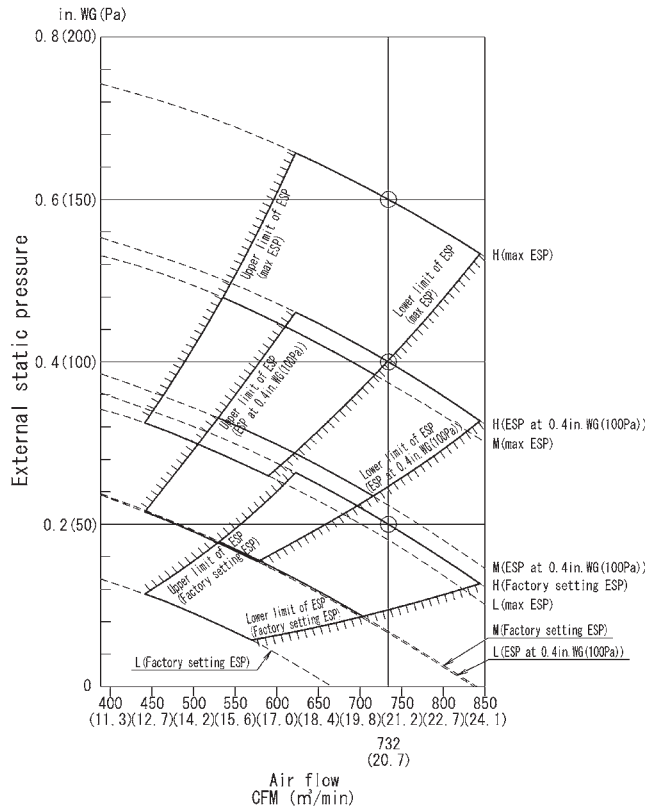

Fan characteristics ②  
(For field setting of remote controller)

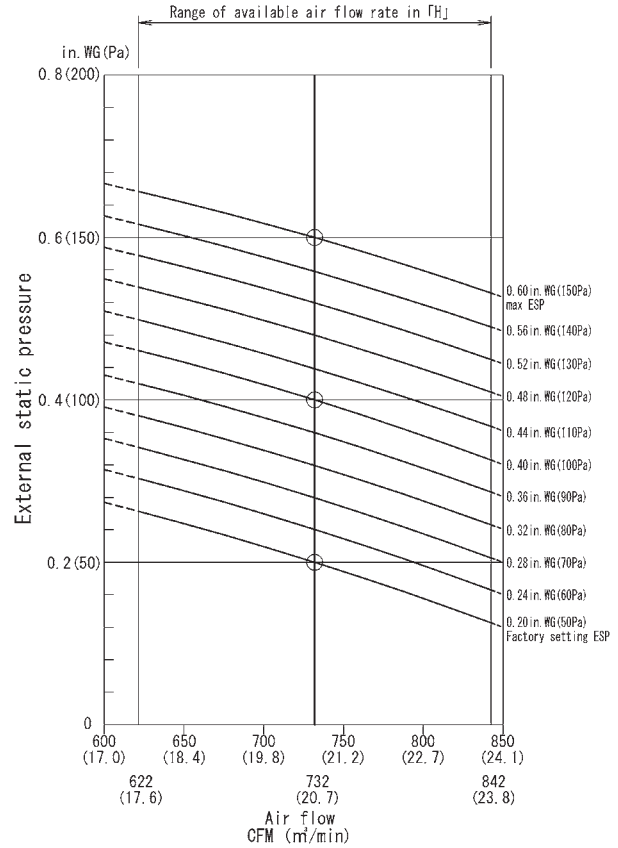

Notes:

1. Fan characteristics at the time of rear suction and bottom suction are similar to each other.
2. Fan characteristics ① shows a representative of fan characteristics at the time of "Maximum ESP", "ESP at 0.4in. WG (100Pa)" and "Factory setting ESP".
3. A remote controller can be used to change airflow rate of "H", "M" and "L".
4. Set the ESP on suction side to 0.4in. WG (100Pa) or less.
5. Fan characteristics ② (for field setting of remote controller) shows fan characteristics of airflow "H" which can be changed in the field setting by a remote controller.
6. Select ESP setting in accordance with resistance of the connected duct by using Fan characteristics ① and ② (Factory setting ESP is 0.2in. WG (50Pa). See installation manual for ESP setting procedure.)
7. The ESP setting of this unit can be changed into 10 levels.
8. The value of Fan characteristics ② mentioned in this drawing shows the ESP of rated airflow.

ESP : external static pressure

## 9.2 Airflow Auto Adjustment FDMQ12WVJU9

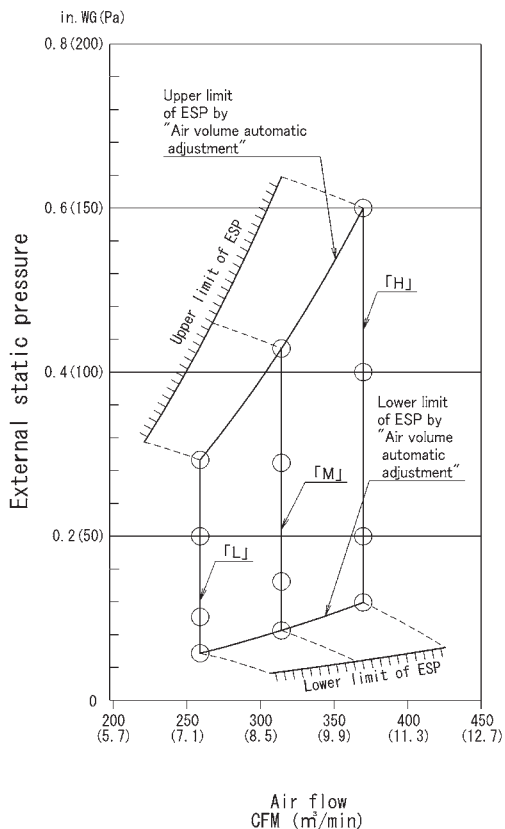

- Notes :
1. This indoor unit has the "Air volume automatic adjustment" function, which automatically adjusts the air flow rate so as to be approximately in the range of  $\pm 10\%$  of the rated value, at the time of installation.
  2. After duct construction completion, please perform field setting "Air volume automatic adjustment" by remote controller.
  3. About the field setting method of the "Air volume automatic adjustment", look at the installation manual which is attached to an indoor unit.
  4. ESP that can adjust by "Air volume automatic adjustment" function is 0.12in.WG (30Pa) - 0.6in.WG(150Pa) (When air flow is "H").
  5. If the unit is used beyond the range of the above-mentioned ESP, the air flow rate can not be well-adjusted automatically, and the unit will operate with the air flow rate different from the rated value.
  6. This figure shows a fan characteristics at the time of "H" "M" and "L".
  7. The remote controller can be used to change "H" "M" and "L".

ESP : external static pressure.

3D141702

## FDMQ18WVJU9

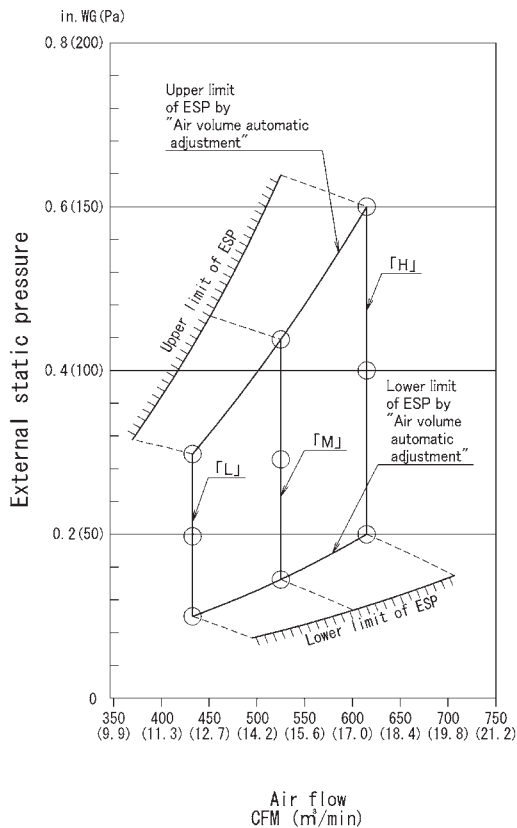

- Notes :
1. This indoor unit has the "Air volume automatic adjustment" function, which automatically adjusts the air flow rate so as to be approximately in the range of  $\pm 10\%$  of the rated value, at the time of installation.
  2. After duct construction completion, please perform field setting "Air volume automatic adjustment" by remote controller.
  3. About the field setting method of the "Air volume automatic adjustment", look at the installation manual which is attached to an indoor unit.
  4. ESP that can adjust by "Air volume automatic adjustment" function is 0.2in.WG (50Pa) - 0.6in.WG(150Pa) (When air flow is "H").
  5. If the unit is used beyond the range of the above-mentioned ESP, the air flow rate can not be well-adjusted automatically, and the unit will operate with the air flow rate different from the rated value.
  6. This figure shows a fan characteristics at the time of "H" "M" and "L".
  7. The remote controller can be used to change "H" "M" and "L".

ESP : external static pressure.

3D141704

FDMQ24WVJU9

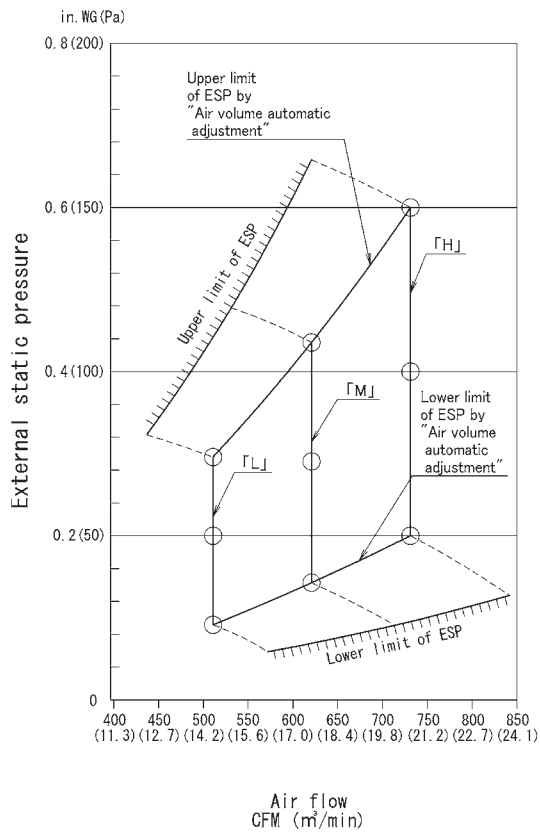

Notes :

1. This indoor unit has the "Air volume automatic adjustment" function, which automatically adjusts the air flow rate so as to be approximately in the range of  $\pm 10\%$  of the rated value, at the time of installation.
2. After duct construction completion, please perform field setting "Air volume automatic adjustment" by remote controller.
3. About the field setting method of the "Air volume automatic adjustment", look at the installation manual which is attached to an indoor unit.
4. ESP that can adjust by "Air volume automatic adjustment" function is 0.2in.WG (50Pa) - 0.6in.WG (150Pa) (When air flow is "H").
5. If the unit is used beyond the range of the above-mentioned ESP, the air flow rate can not be well-adjusted automatically, and the unit will operate with the air flow rate different from the rated value.
6. This figure shows a fan characteristics at the time of "H" "M" and "L".
7. The remote controller can be used to change "H" "M" and "L".

ESP : external static pressure.

3D141705

# 10. Sound Level

## 10.1 Measuring Location

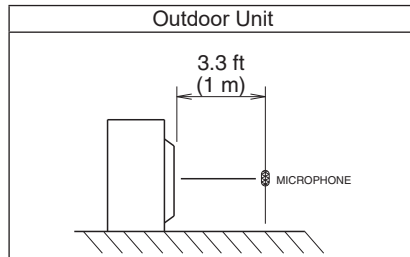
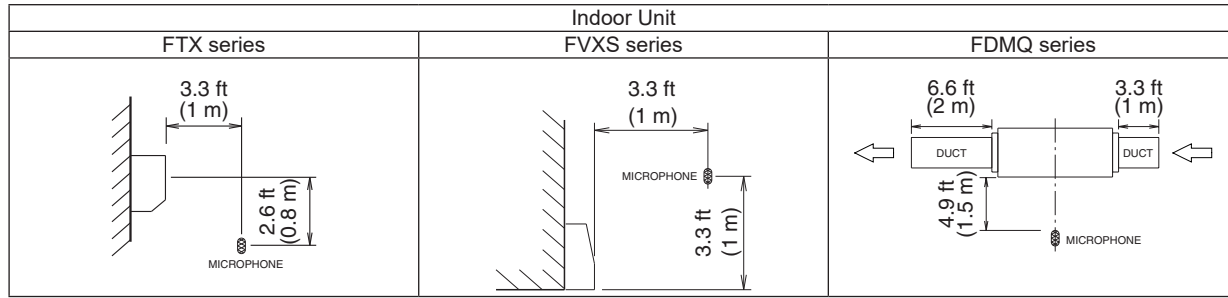

- Notes:**
1. Operation sound is measured in an anechoic chamber.
  2. The data are based on the conditions shown in the table below.

	Cooling	Heating	Piping Length
Indoor	80°FDB (26.7°CDB) / 67°FWB (19.4°CWB)	70°FDB (21°CDB) / 60°FWB (15.6°CWB)	25 ft (7.5 m)
Outdoor	95°FDB (35°CDB) / 75°FWB (24°CWB)	47°FDB (8.3°CDB) / 43°FWB (6°CWB)	

# 10.2 Indoor Unit FTX09WMVJU9

## COOLING

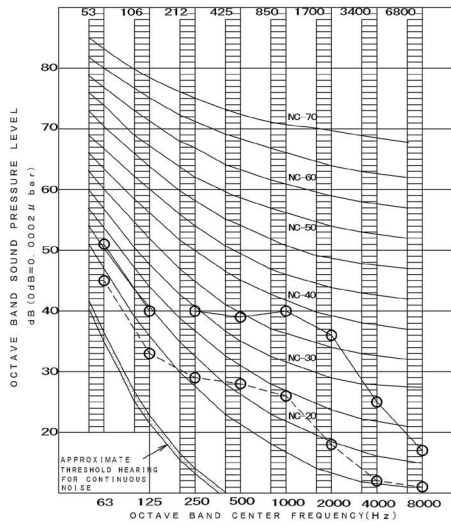

OVER ALL (dB)			OPERATING CONDITIONS	
	60Hz	60Hz	POWER SOURCE	208/230 V 60 Hz
SCALE	208/230v (H)	208/230v (L)	<b>JIS STANDARD</b>	
A	43	30	○—○	60Hz 208/230v (H)
			○- - -○	60Hz 208/230v (L)

(B.G.N IS ALREADY RECTIFIED) **Cooling**

## HEATING

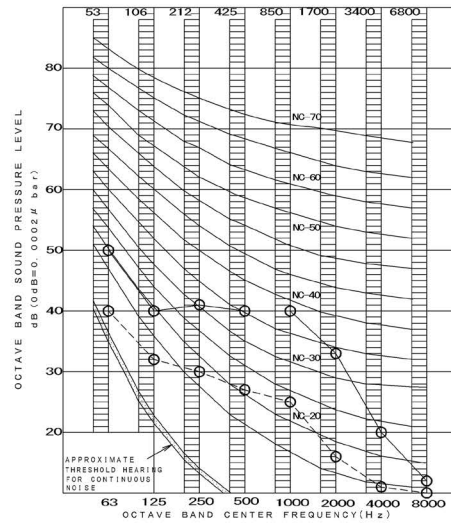

OVER ALL (dB)			OPERATING CONDITIONS	
	60Hz	60Hz	POWER SOURCE	208/230 V 60 Hz
SCALE	208/230v (H)	208/230v (L)	<b>JIS STANDARD</b>	
A	43	29	○—○	60Hz 208/230v (H)
			○- - -○	60Hz 208/230v (L)

(B.G.N IS ALREADY RECTIFIED) **Heating**

3D092957B

# FTX12WMVJU9

## COOLING

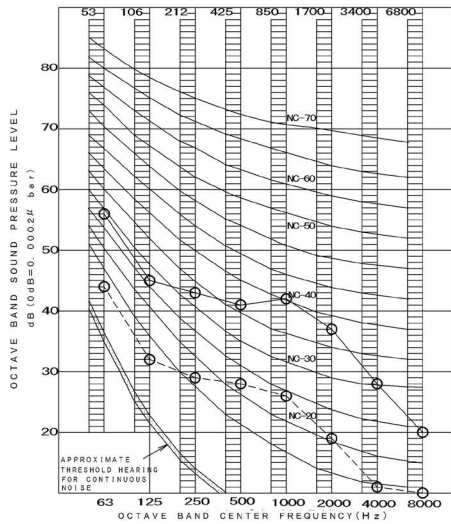

OVER ALL (dB)			OPERATING CONDITIONS	
	60Hz	60Hz	POWER SOURCE	208/230 V 60 Hz
SCALE	208/230v (H)	208/230v (L)	<b>JIS STANDARD</b>	
A	45	30	○—○	60Hz 208/230v (H)
			○- - -○	60Hz 208/230v (L)

(B.G.N IS ALREADY RECTIFIED) **Cooling**

## HEATING

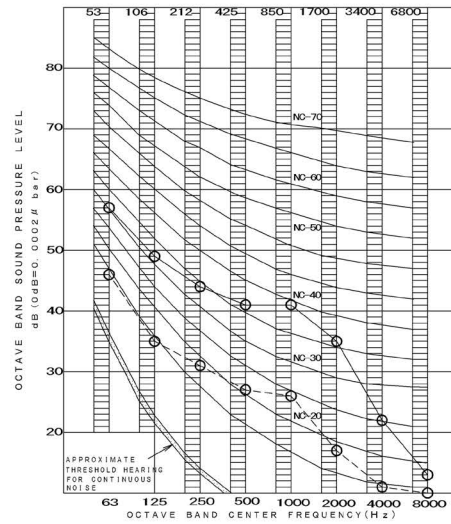

OVER ALL (dB)			OPERATING CONDITIONS	
	60Hz	60Hz	POWER SOURCE	208/230 V 60 Hz
SCALE	208/230v (H)	208/230v (L)	<b>JIS STANDARD</b>	
A	45	30	○—○	60Hz 208/230v (H)
			○- - -○	60Hz 208/230v (L)

(B.G.N IS ALREADY RECTIFIED) **Heating**

3D092886B

FTX15WMVJU9

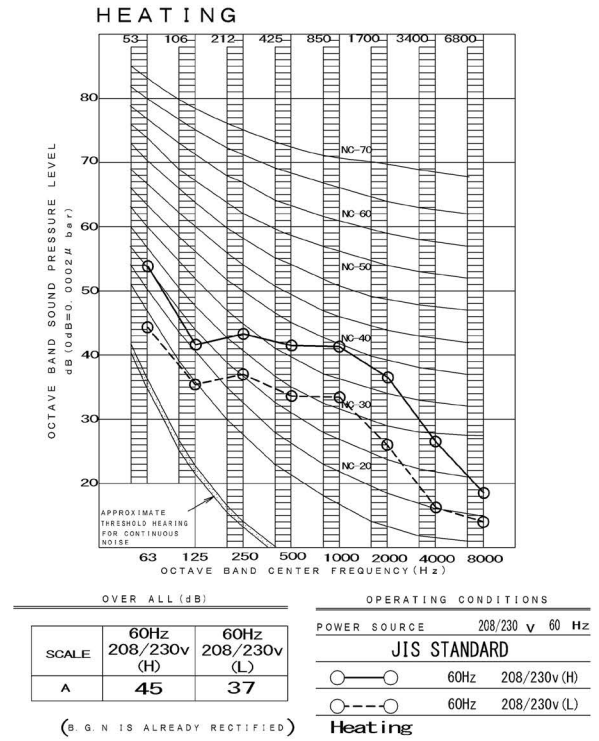
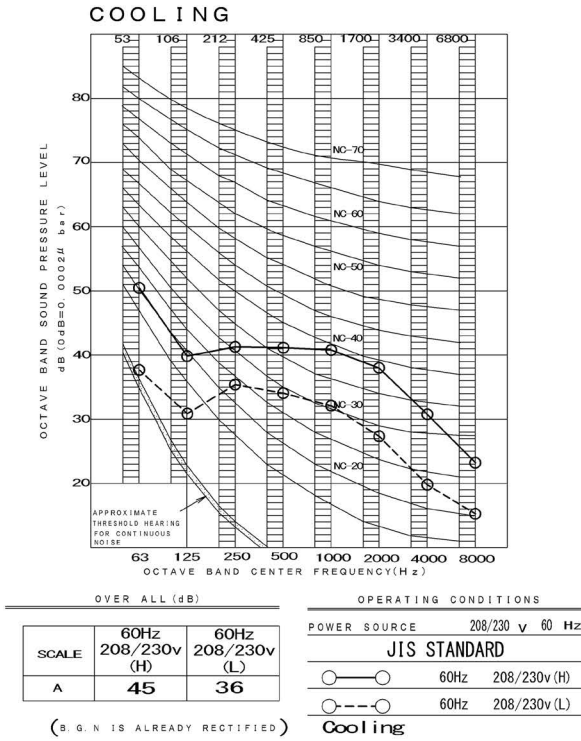

3D100354A

FTX18WVJU9

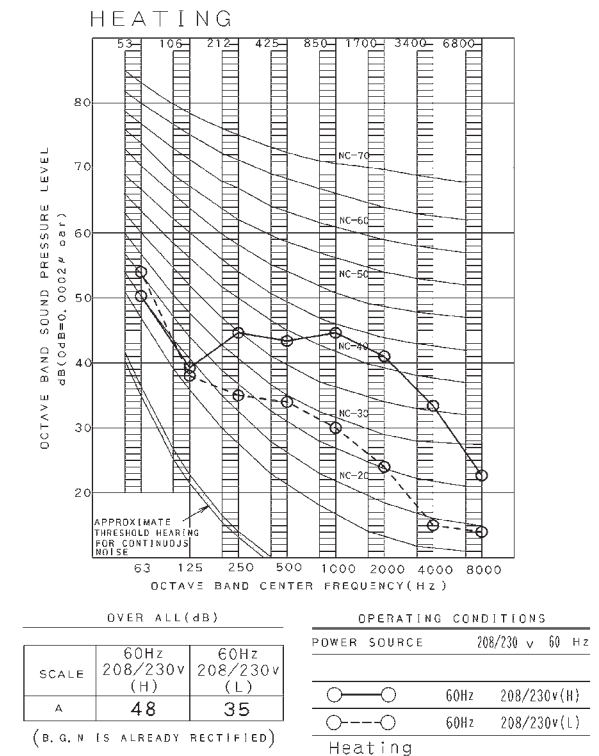
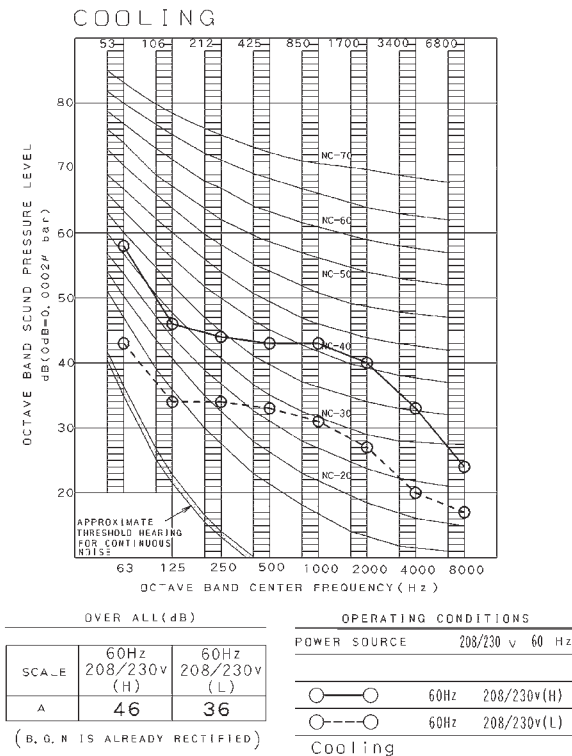

3D123455

**FTX24WVJU9**

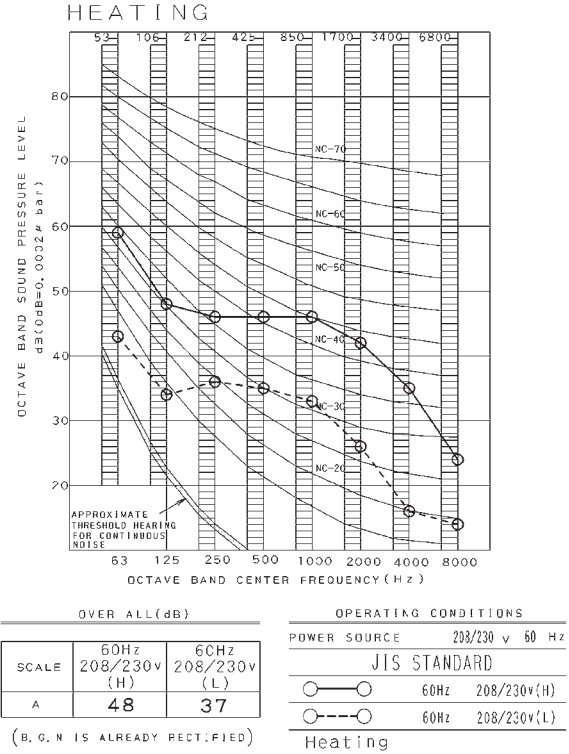
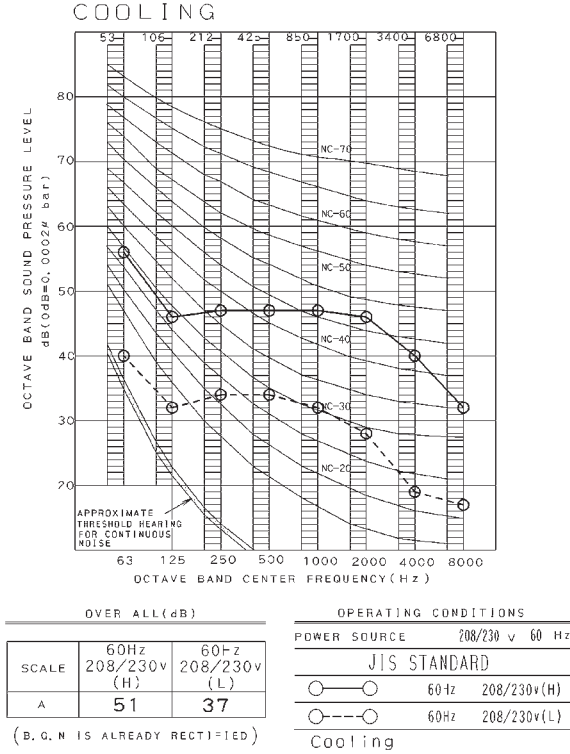

3D074866A

**FVXS09WVJU9**

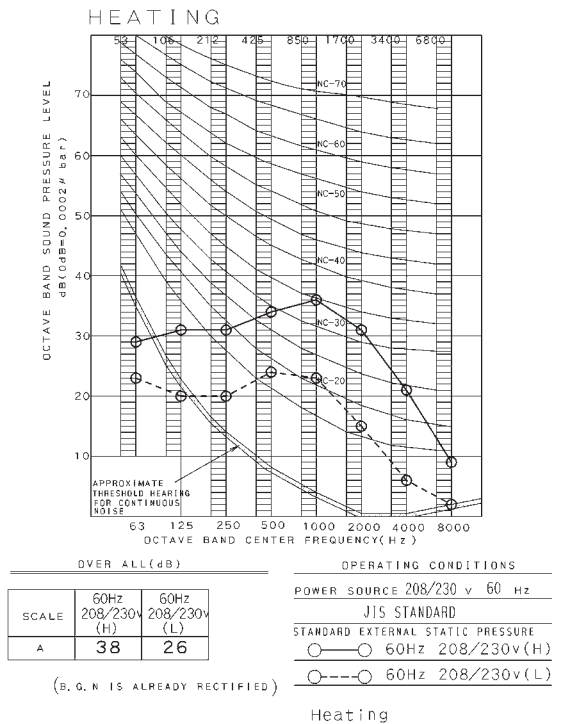
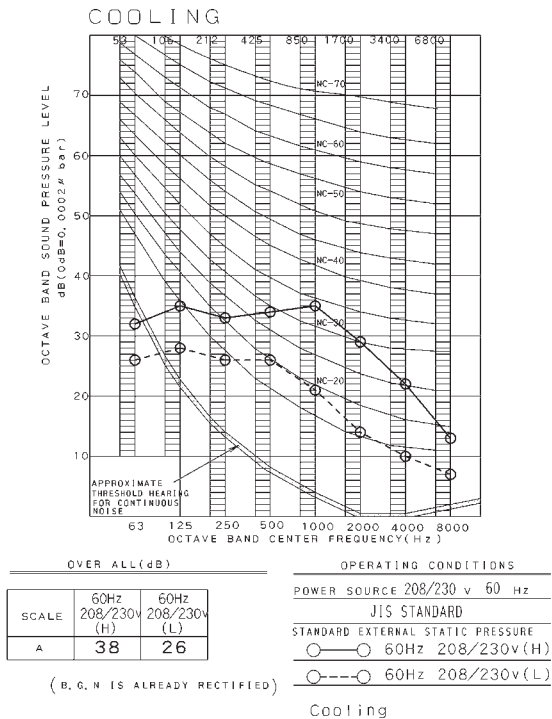

3D094737A



**FVXS12WVJU9**

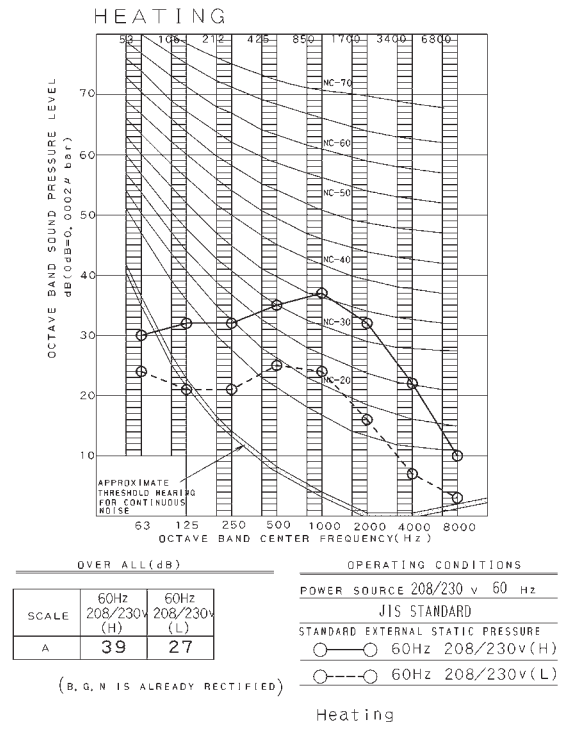
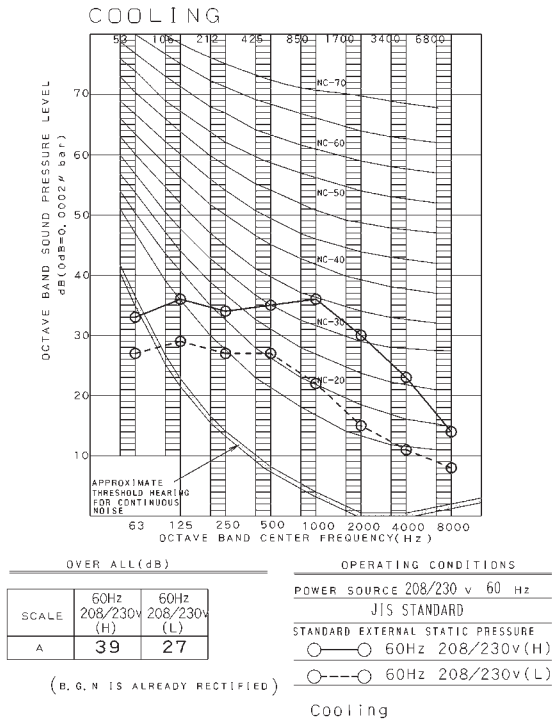

3D094766A

**FVXS15WVJU9**

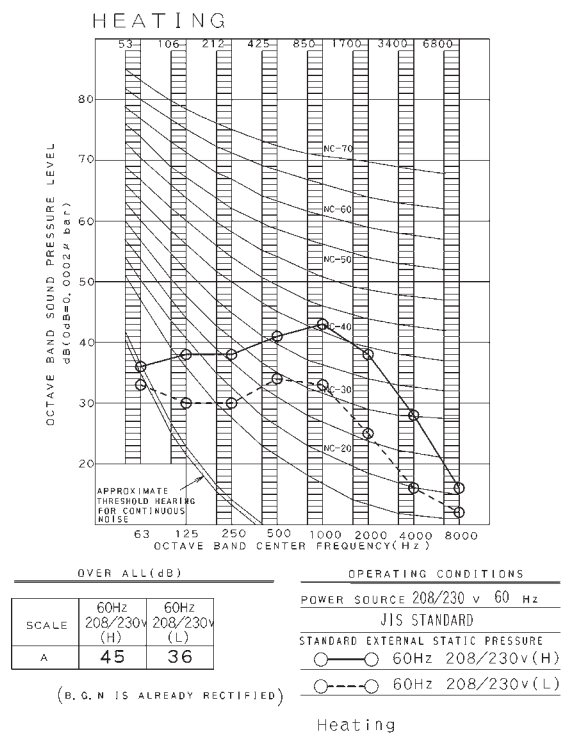
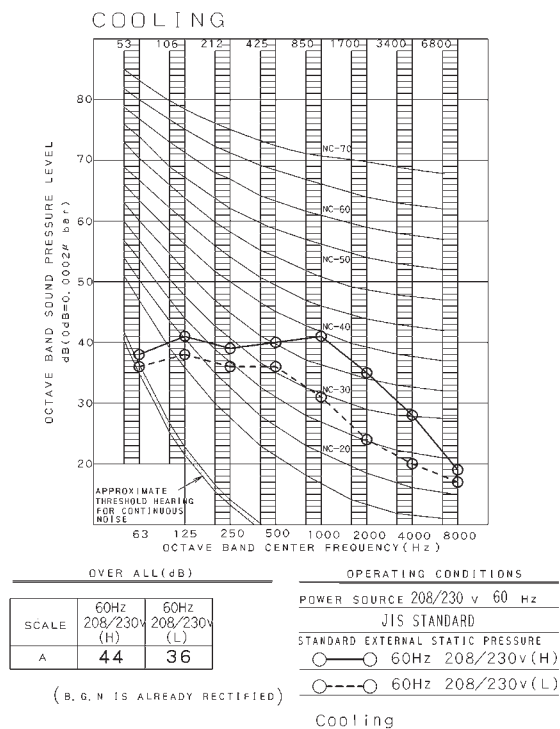

3D094777B

FDMQ12WVJU9

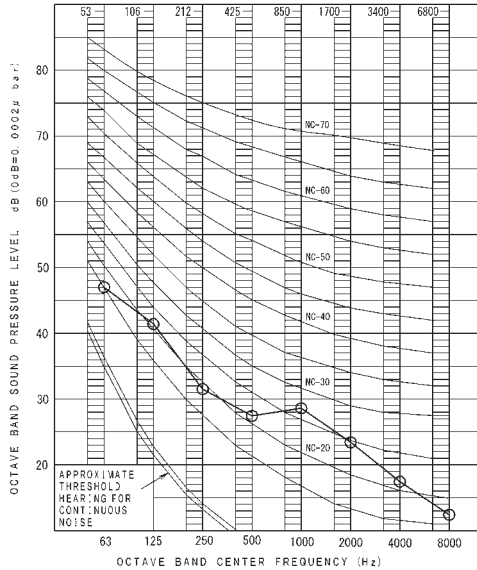

OVER ALL (dB)

SCALE	AIR FLOW RATE
A	33.0

(B. G. N IS ALREADY RECTIFIED)

OPERATING CONDITIONS  
 POWER SOURCE 208/230V 60Hz  
 COOLING RETURN AIR TEMPERATURE : 80.0 ° F (26.7 ° C) DB 67.0 ° F (19.4 ° C) WB  
 OUTDOOR TEMPERATURE : 95.0 ° F (35.0 ° C) DB 75.0 ° F (23.9 ° C) WB  
 HEATING RETURN AIR TEMPERATURE : 70.0 ° F (21.1 ° C) DB 60.0 ° F (15.6 ° C) WB  
 OUTDOOR TEMPERATURE : 47.0 ° F (8.3 ° C) DB 43.0 ° F (6.1 ° C) WB

FDMQ18WVJU9

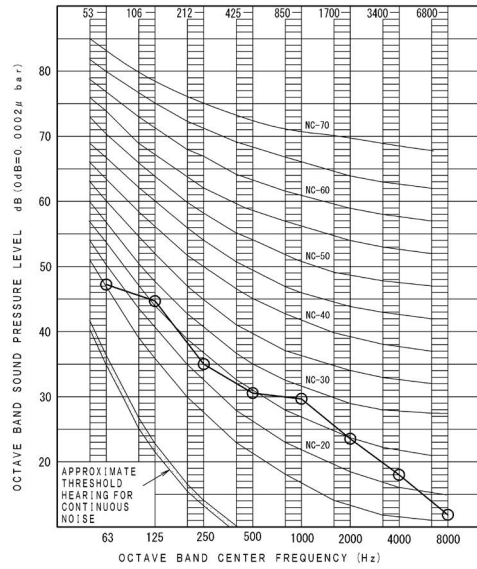

OVER ALL (dB)

SCALE	AIR FLOW RATE
A	35.0

(B. G. N IS ALREADY RECTIFIED)

OPERATING CONDITIONS  
 POWER SOURCE 208/230V 60Hz  
 COOLING RETURN AIR TEMPERATURE : 80.0 ° F (26.7 ° C) DB 67.0 ° F (19.4 ° C) WB  
 OUTDOOR TEMPERATURE : 95.0 ° F (35.0 ° C) DB 75.0 ° F (23.9 ° C) WB  
 HEATING RETURN AIR TEMPERATURE : 70.0 ° F (21.1 ° C) DB 60.0 ° F (15.6 ° C) WB  
 OUTDOOR TEMPERATURE : 47.0 ° F (8.3 ° C) DB 43.0 ° F (6.1 ° C) WB

4D113010B

4D113012A

FDMQ24WVJU9

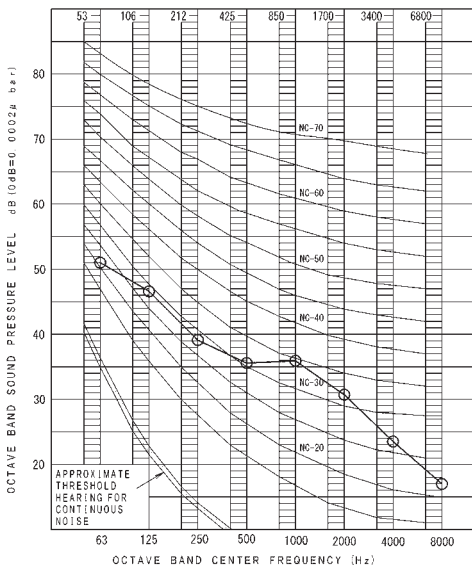

OVER ALL (dB)

SCALE	AIR FLOW RATE
A	40.0

(B. G. N IS ALREADY RECTIFIED)

OPERATING CONDITIONS  
 POWER SOURCE 208/230V 60Hz  
 COOLING RETURN AIR TEMPERATURE : 80.0 ° F (26.7 ° C) DB 67.0 ° F (19.4 ° C) WB  
 OUTDOOR TEMPERATURE : 95.0 ° F (35.0 ° C) DB 75.0 ° F (23.9 ° C) WB  
 HEATING RETURN AIR TEMPERATURE : 70.0 ° F (21.1 ° C) DB 60.0 ° F (15.6 ° C) WB  
 OUTDOOR TEMPERATURE : 47.0 ° F (8.3 ° C) DB 43.0 ° F (6.1 ° C) WB

4D113013A

### 10.3 Outdoor Unit RXL09WMVJU9

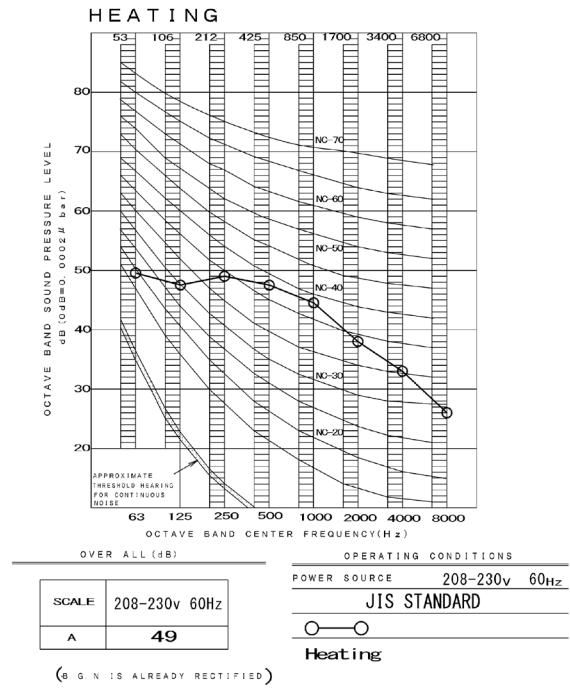
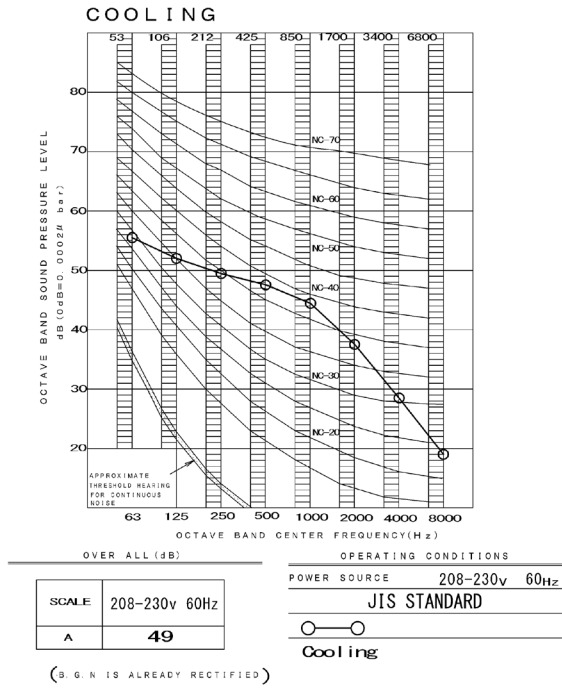

3D100630A

### RXL12WMVJU9

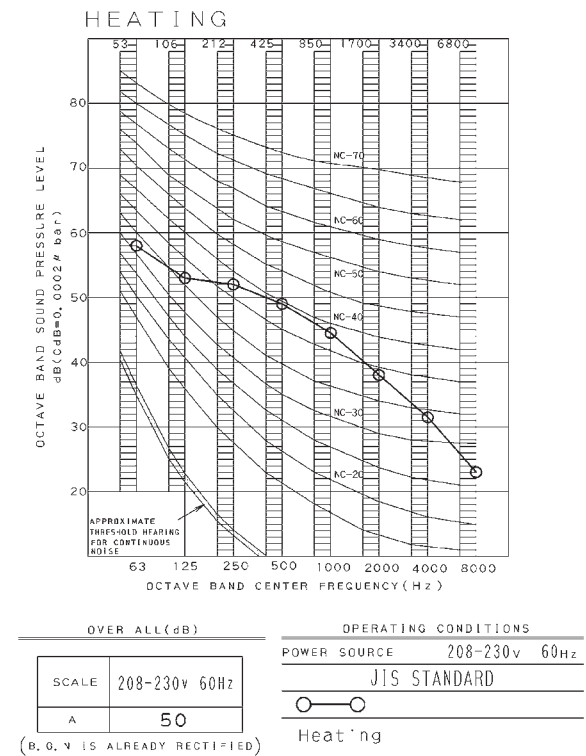
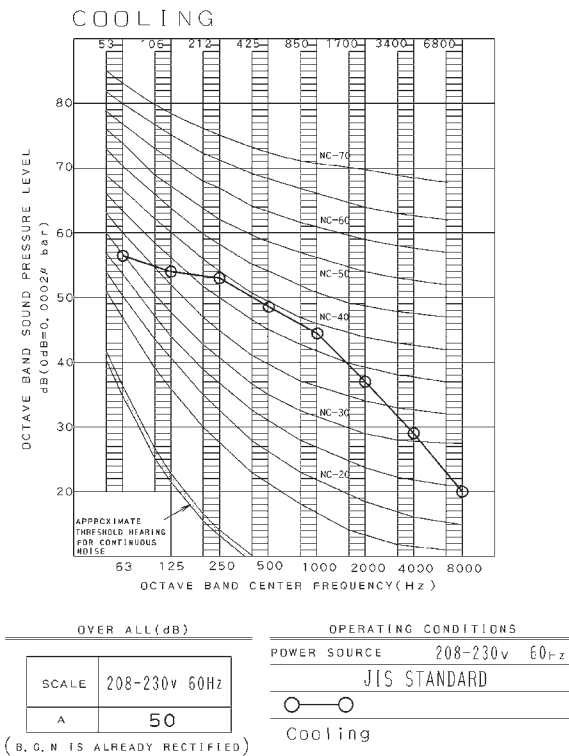

3D100632A

RXL15WMVJU9

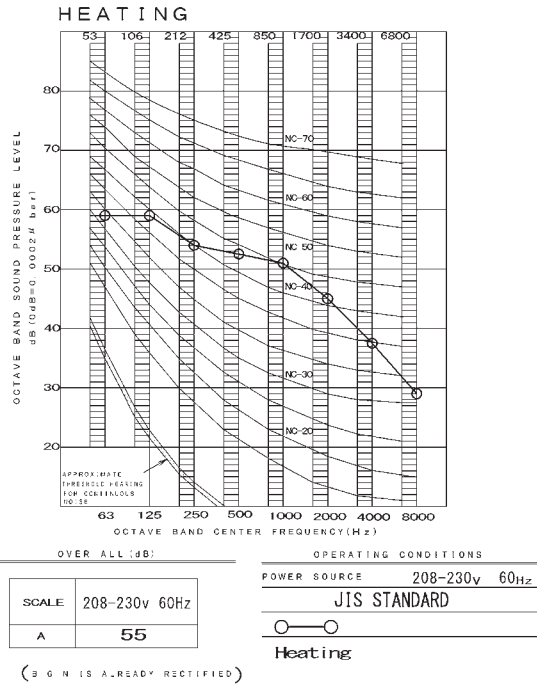
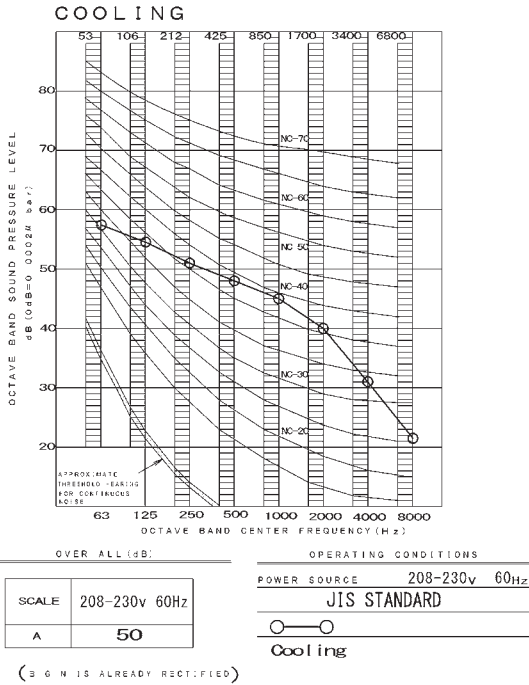

3D100636A

RXL18WMVJU9

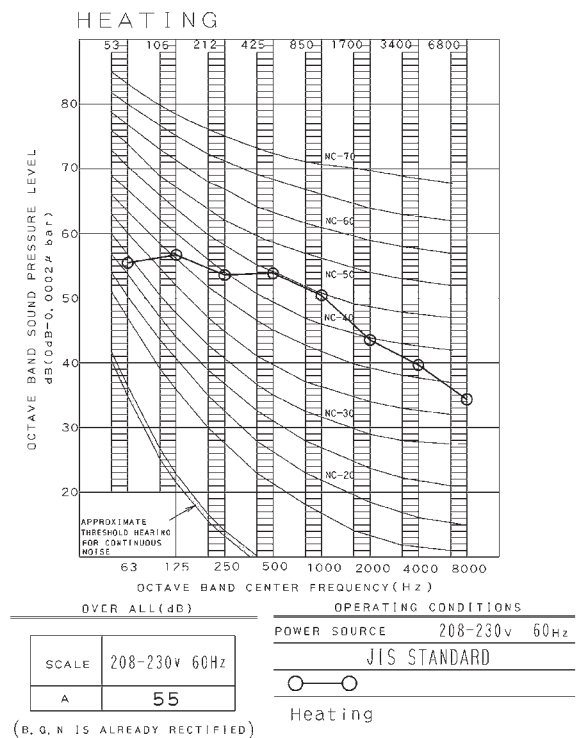
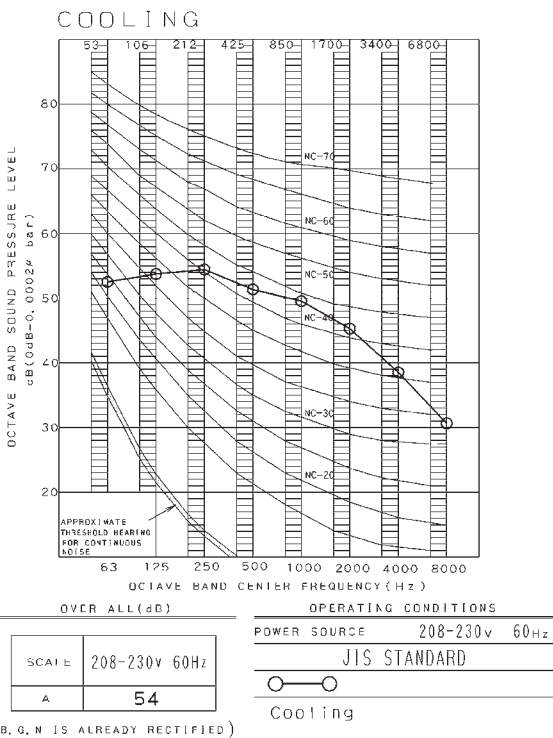

3D123453

RXL24WMVJU9

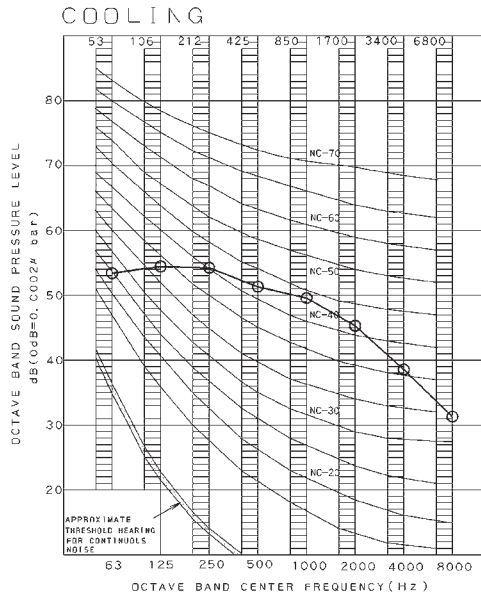

OVER ALL (dB)		OPERATING CONDITIONS	
SCALE	208-230V 60Hz	POWER SOURCE	208-230V 60Hz
A	55		JIS STANDARD
		Cooling	

(B. G. N IS ALREADY RECTIFIED)

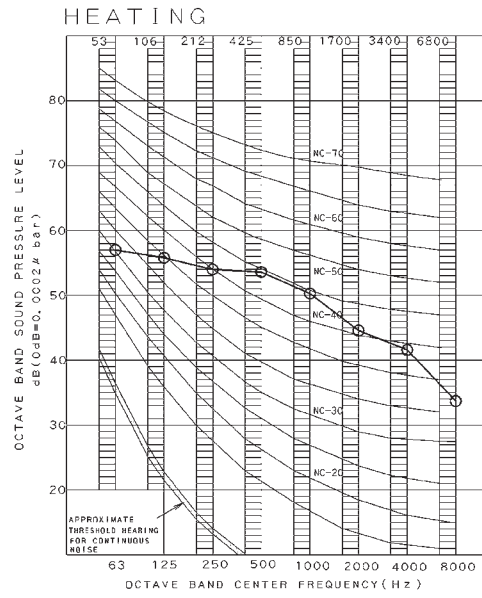

OVER ALL (dB)		OPERATING CONDITIONS	
SCALE	208-230V 60Hz	POWER SOURCE	208-230V 60Hz
A	55		JIS STANDARD
		Heating	

(B. G. N IS ALREADY RECTIFIED)

3D123454

# 11. Electric Characteristics

Indoor Unit	Outdoor Unit	Power Supply				Compressor	OFM			IFM		
		Hz - Volts	Voltage Range	MCA	MFA		RLA	Hp	W	FLA	Hp	W
FTX09WMVJU9	RXL09WMVJU9	60 Hz - 208 V 60 Hz - 230 V	Max. 60 Hz, 253 V Min. 60 Hz, 187 V	8.7	15	8.5	0.03	23	0.19	0.03	21	0.20
FTX12WMVJU9	RXL12WMVJU9	60 Hz - 208 V 60 Hz - 230 V	Max. 60 Hz, 253 V Min. 60 Hz, 187 V	12.2	15	12.0	0.04	27	0.21	0.04	28	0.23
FTX15WMVJU9	RXL15WMVJU9	60 Hz - 208 V 60 Hz - 230 V	Max. 60 Hz, 253 V Min. 60 Hz, 187 V	12.2	15	12.0	0.12	93	0.58	0.05	33	0.23
FTX18WVJU9	RXL18WMVJU9	60 Hz - 208 V 60 Hz - 230 V	Max. 60 Hz, 253 V Min. 60 Hz, 187 V	18.6	20	18.3	0.16	122	0.77	0.07	48	0.37
FTX24WVJU9	RXL24WMVJU9	60 Hz - 208 V 60 Hz - 230 V	Max. 60 Hz, 253 V Min. 60 Hz, 187 V	18.8	20	18.3	0.16	122	0.77	0.07	48	0.57
FVXS09WVJU9	RXL09WMVJU9	60 Hz - 208 V 60 Hz - 230 V	Max. 60 Hz, 253 V Min. 60 Hz, 187 V	8.7	15	8.5	0.03	23	0.19	0.02	12	0.21
FVXS12WVJU9	RXL12WMVJU9	60 Hz - 208 V 60 Hz - 230 V	Max. 60 Hz, 253 V Min. 60 Hz, 187 V	12.2	15	12.0	0.04	27	0.21	0.02	13	0.22
FVXS15WVJU9	RXL15WMVJU9	60 Hz - 208 V 60 Hz - 230 V	Max. 60 Hz, 253 V Min. 60 Hz, 187 V	12.3	15	12.0	0.12	93	0.58	0.03	23	0.29
FDMQ12WVJU9	RXL12WMVJU9	60 Hz - 208 V 60 Hz - 230 V	Max. 60 Hz, 253 V Min. 60 Hz, 187 V	12.6	15	12.0	0.04	27	0.21	0.17	130	0.63
FDMQ18WVJU9	RXL18WMVJU9	60 Hz - 208 V 60 Hz - 230 V	Max. 60 Hz, 253 V Min. 60 Hz, 187 V	19.1	20	18.3	0.16	122	0.77	0.31	230	0.84
FDMQ24WVJU9	RXL24WMVJU9	60 Hz - 208 V 60 Hz - 230 V	Max. 60 Hz, 253 V Min. 60 Hz, 187 V	19.3	20	18.3	0.16	122	0.77	0.31	230	1.10

**Symbols:**

- MCA : Min. circuit amps (A)
- MFA : Max. fuse amps (A)
- RLA : Rated load amps (A)
- OFM : Outdoor fan motor
- IFM : Indoor fan motor
- FLA : Full load amps (A)
- W / Hp : Fan motor rated output (W, Hp)

**Notes:**

1. RLA is the max current that comes in cooling operation and heating operation.
2. Maximum allowable voltage variation between phases is 2%.
3. Select wire size based on the larger value of MCA.

C: 3D143137  
C: 3D143133A

# 12. Installation Manual

## 12.1 FTX09/12/15

# Contents

<b>Safety Considerations .....</b>	<b>1</b>	<b>Refrigerant Piping Work .....</b>	<b>9</b>
<b>Accessories .....</b>	<b>3</b>	1. Flaring the pipe end.....	9
<b>Choosing an Installation Site .....</b>	<b>3</b>	2. Refrigerant piping .....	9
1. Indoor unit .....	3	<b>Installation Tips .....</b>	<b>10</b>
2. Wireless remote controller.....	3	1. Removing and installing the front panel .....	10
<b>Indoor Unit Installation Diagram .....</b>	<b>4</b>	2. Removing and installing the front grille.....	11
<b>Indoor Unit Installation .....</b>	<b>5</b>	3. How to set the different addresses .....	11
1. Installing the mounting plate.....	5	<b>Trial Operation and Testing .....</b>	<b>12</b>
2. Drilling a wall hole and installing wall embedded pipe ...	6	1. Trial operation and testing .....	12
3. Installing the indoor unit .....	6	2. Test items .....	12
4. Wiring .....	8		
5. Drain piping .....	8		

The pictures in this document are for illustrative purposes only.

# Safety Considerations

Refer also to the General Safety Considerations in the separate booklet.







**Read the precautions in this manual carefully before operating the unit.**

Read these **Safety Considerations for Installation** carefully before installing an air conditioner or heat pump. After completing the installation, make sure that the unit operates properly during the startup operation. Instruct the user on how to operate and maintain the unit. Inform users that they should store this installation manual with the operation manual for future reference. Always use a licensed installer or contractor to install this product.

Improper installation can result in water or refrigerant leakage, electric shock, fire, or explosion.

Meanings of **DANGER**, **WARNING**, **CAUTION**, and **NOTE** Symbols:

-  **DANGER** ..... Indicates an imminently hazardous situation which, if not avoided, will result in death or serious injury.
-  **WARNING** ..... Indicates a potentially hazardous situation which, if not avoided, could result in death or serious injury.
-  **CAUTION** ..... Indicates a potentially hazardous situation which, if not avoided, may result in minor or moderate injury. It may also be used to alert against unsafe practices.
-  **NOTE** ..... Indicates situations that may result in equipment or property damage accidents only.

 **DANGER** \_\_\_\_\_

- Refrigerant gas is heavier than air and replaces oxygen. A massive leak can lead to oxygen depletion, especially in basements, and an asphyxiation hazard could occur leading to serious injury or death.
- Do not ground units to water pipes, gas pipes, telephone wires, or lightning rods as incomplete grounding can cause a severe shock hazard resulting in severe injury or death. Additionally, grounding to gas pipes could cause a gas leak and potential explosion causing severe injury or death.

- If refrigerant gas leaks during installation, ventilate the area immediately. Refrigerant gas may produce toxic gas if it comes into contact with fire. Exposure to this gas could cause severe injury or death.
- After completing the installation work, check that the refrigerant gas does not leak throughout the system.
- Do not install unit in an area where flammable materials are present due to risk of explosions that can cause serious injury or death.
- Safely dispose all packing and transportation materials in accordance with federal/state/local laws or ordinances. Packing materials such as nails and other metal or wood parts, including plastic packing materials used for transportation may cause injuries or death by suffocation.

 **WARNING** \_\_\_\_\_

- Only qualified personnel licensed or certified in their jurisdiction must carry out the installation work. Installation must be done in accordance with this installation manual. Improper installation may result in water leakage, electric shock, or fire.
- When installing the unit in a small room, take measures to keep the refrigerant concentration from exceeding allowable safety limits. Excessive refrigerant leaks, in the event of an accident in a closed ambient space, can lead to oxygen deficiency.
- Use only specified accessories and parts for installation work. Failure to use specified parts may result in water leakage, electric shock, fire, or the unit falling.
- Install the air conditioner or heat pump on a foundation strong enough that it can withstand the weight of the unit. A foundation of insufficient strength may result in the unit falling and causing injuries.
- Take into account strong winds, typhoons, or earthquakes when installing. Improper installation may result in the unit falling and causing accidents.
- Make sure that a separate power supply circuit is provided for this unit and that all electrical work is carried out by qualified personnel licensed or certified in their jurisdiction according to local, state, and national regulations. An insufficient power supply capacity or improper electrical construction may lead to electric shock or fire.
- Make sure that all wiring is secured, that specified wires are used, and that no external forces act on the terminal connections or wires. Improper connections or installation may result in fire.



- When wiring, position the wires so that the electrical wiring box cover can be securely fastened. Improper positioning of the electrical wiring box cover may result in electric shock, fire, or the terminals overheating.
- Before touching electrical parts, turn off the unit.
- The circuit must be protected with safety devices in accordance with local and national codes, i.e. a circuit breaker.
- Securely fasten the outdoor unit terminal cover (panel). If the terminal cover/panel is not installed properly, dust or water may enter the outdoor unit causing fire or electric shock.
- When installing or relocating the system, keep the refrigerant circuit free from substances other than the specified refrigerant (R410A) such as air. Any presence of air or other foreign substance in the refrigerant circuit can cause an abnormal pressure rise or rupture, resulting in equipment damage and even injury.
- Do not change the setting of the protection devices. If the pressure switch, thermal switch, or other protection device is shorted and operated forcibly, or parts other than those specified by Daikin are used, fire or explosion may occur.
- Do not use means to accelerate the defrosting process (if possible) or to clean, other than those recommended by the manufacturer.
- The appliance must be stored in a room without continuously operating ignition sources (for example: open flames, an operating gas appliance or an operating electric heater).
- Do not pierce or burn.
- Be aware that refrigerants may not contain an odor.
- Comply with national gas regulations.

**CAUTION**

- Do not touch the switch with wet fingers. Touching a switch with wet fingers can cause electric shock.
- Do not allow children to play on or around the unit to prevent injury.
- Wear adequate personal protective equipment (protective gloves, safety glasses,...) when installing, maintaining or servicing the system.
- The heat exchanger fins are sharp enough to cut. To avoid injury, wear gloves or cover the fins while working around them.
- Do not touch the refrigerant pipes during and immediately after operation as the refrigerant pipes may be hot or cold, depending on the condition of the refrigerant flowing through the refrigerant piping, compressor, and other refrigerant cycle parts. Your hands may suffer burns or frostbite if you touch the refrigerant pipes. To avoid injury, give the pipes time to return to normal temperature or, if you must touch them, be sure to wear proper gloves.
- Install drain piping to ensure proper drainage. Improper drain piping may result in water leakage and property damage.
- Insulate piping to prevent condensation.
- Be careful when transporting the product.
- Do not turn off the power immediately after stopping operation. Always wait for at least 5 minutes before turning off the power. Otherwise, water leakage may occur.
- Do not use a charging cylinder. Using a charging cylinder may cause the refrigerant to deteriorate.
- Refrigerant R410A in the system must be kept clean, dry, and tight.

- (a) Clean and Dry -- Foreign materials (including mineral oils such as SUNISO oil or moisture) should be prevented from getting into the system.









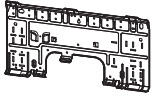

- (b) Tight -- R410A does not contain any chlorine, does not destroy the ozone layer, and does not reduce the earth's protection against harmful ultraviolet radiation. R410A can contribute to the greenhouse effect if it is released. Therefore take proper measures to check for the tightness of the refrigerant piping installation. Read the chapter *Refrigerant Piping Work* and follow the procedures.
- Since R410A is a blend, the required additional refrigerant must be charged in its liquid state. If the refrigerant is charged in a state of gas, its composition can change and the system will not work properly.
- The indoor unit is for R410A. See the catalog for outdoor models that can be connected. Normal operation is not possible when connected to non-compatible outdoor units.
- Remote controller (wireless kit) transmitting distance can be shorter than expected in rooms with electronic fluorescent lamps (inverter or rapid start types). Install the indoor unit far away from fluorescent lamps as much as possible.
- Indoor units are for indoor installation only. Outdoor units can be installed either outdoors or indoors.
- Do not install the air conditioner or heat pump in the following locations:
  - (a) Where a mineral oil mist or oil spray or vapor is produced, for example, in a kitchen. Plastic parts may deteriorate and fall off or result in water leakage.
  - (b) Where corrosive gas, such as sulfurous acid gas, is produced. Corroding copper pipes or soldered parts may result in refrigerant leakage.
  - (c) Near machinery emitting electromagnetic waves. Electromagnetic waves may disturb the operation of the control system and cause the unit to malfunction.
  - (d) Where flammable gas may leak, where there is carbon fiber, or ignitable dust suspension in the air, or where volatile flammables such as thinner or gasoline are handled. Operating the unit in such conditions can cause a fire.
- Take adequate measures to prevent the outdoor unit from being used as a shelter by small animals. Small animals making contact with electrical parts can cause malfunctions, smoke, or fire. Instruct the user to keep the area around the unit clean.
- Servicing shall be performed only as recommended by the manufacturer and licensed or certified in their jurisdiction.

**NOTE**

- The indoor unit should be positioned where the unit and inter-unit wires (outdoor to indoor) are at least 3.3ft (1m) away from any televisions or radios. (The unit may cause interference with the picture or sound.) Depending on the radio waves, a distance of 3.3ft (1m) may not be sufficient to eliminate the noise.
- Dismantling the unit, treatment of the refrigerant, oil and additional parts must be done in accordance with the relevant local, state, and national regulations.
- Only use tools for R410A, such as a gauge manifold, charge hose, gas leak detector, reverse flow check valve, refrigerant charge base, vacuum gauge, or refrigerant recovery equipment.
- If the conventional refrigerant and refrigerator oil are mixed in R410A, the refrigerant may deteriorate.
- This air conditioner or heat pump is an appliance that should not be accessible to the general public.
- As maximum allowable pressure is 604psi (4.17MPa), the wall thickness of field-installed pipes should be selected in accordance with the relevant local, state, and national regulations.

FTN005-U

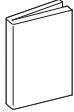
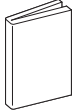
# Accessories

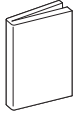
<p>Ⓐ Mounting plate</p>  <p>1</p>	<p>Ⓑ Mounting plate fixing screw M4 × 1" (M4 × 25mm)</p>  <p>7</p>	<p>Ⓒ Titanium apatite deodorizing filter</p> <p>09/12 class    15 class</p>  <p>2</p>
<p>Ⓓ Wireless remote controller</p>  <p>1</p>	<p>Ⓔ Remote controller holder</p>  <p>1</p>	<p>Ⓕ Remote controller holder fixing screw M3 × 13/16" (M3 × 20mm)</p>  <p>2</p>
<p>Ⓖ Dry battery AAA. LR03 (alkaline)</p>  <p>2</p>	<p>Ⓗ Indoor unit fixing screw M4 × 1/2" (M4 × 12mm)</p>  <p>2</p>	<p>Ⓖ Insulation tape</p>  <p>1</p>
<p>Ⓚ Operation manual</p>  <p>1</p>	<p>Ⓛ Installation manual</p>  <p>1</p>	<p>Ⓜ Warranty</p>  <p>1</p>
<p>Ⓝ General safety considerations</p>  <p>1</p>		

## Choosing an Installation Site

- Before choosing the installation site, obtain user approval.

### 1. Indoor unit

- The indoor unit should be positioned in a place where:
  - 1) the restrictions on the installation requirements specified in “**Indoor Unit Installation Diagram**” on page 4 are met,
  - 2) both the air inlet and air outlet are unobstructed,
  - 3) the unit is not exposed to direct sunlight,
  - 4) Install so that drainage occurs easily,
  - 5) the unit is away from sources of heat or steam,
  - 6) there is no source of machine oil vapour (this may shorten the indoor unit service life),
  - 7) cool/warm air is circulated throughout the room,
  - 8) the unit is away from electronic ignition type fluorescent lamps (inverter or rapid start type) as they may affect the remote controller range,
  - 9) the unit is at least 3.3ft (1m) away from any television or radio set (the unit may cause interference with the picture or sound),
  - 10) no laundry equipment is nearby.

### 2. Wireless remote controller

- Turn on all the fluorescent lamps in the room, if any, and find a location where the remote controller signals are properly received by the indoor unit (within 23ft (7m)).

# Indoor Unit Installation Diagram

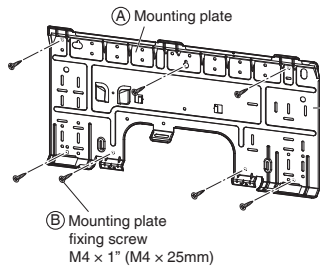

The (A) mounting plate should be installed on a wall which can support the weight of the indoor unit.

- **How to attach the indoor unit**  
Hook the hooks of the bottom frame to the (A) mounting plate. If the hooks are difficult to hook, remove the front grille.
- **How to remove the indoor unit**  
Push up the marked area (at the lower part of the front grille) to release the hooks. If it is difficult to release, remove the front grille.

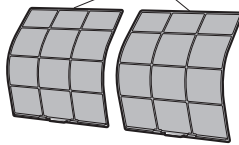
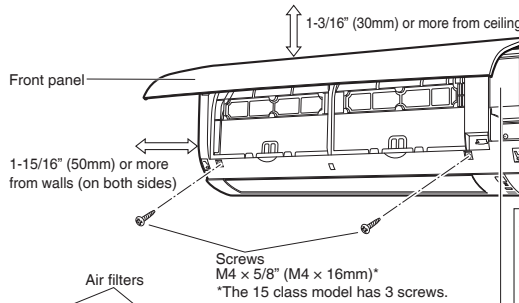
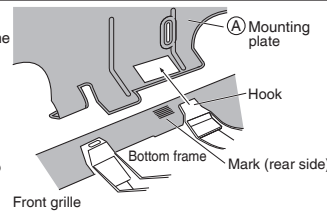

Caulk pipe hole gap with putty.

Do not connect commercially available drain hose directly to the indoor unit. (Water leakage may result)

Wrap with the finishing tape so that no gap is left.

Cut thermal insulation pipe to an appropriate length and wrap it with tape, making sure that no gap is left in the insulation pipe's cut line.

Wrap the insulation pipe with the finishing tape from bottom to top.

Appearance of indoor units may differ from some models. (This is a 09/12 class illustration)

### Service lid

The service lid is removable.

#### ■ Opening method

- 1) Remove the service lid screw.
- 2) Pull out the service lid horizontally in the direction of the arrow.
- 3) Pull down.

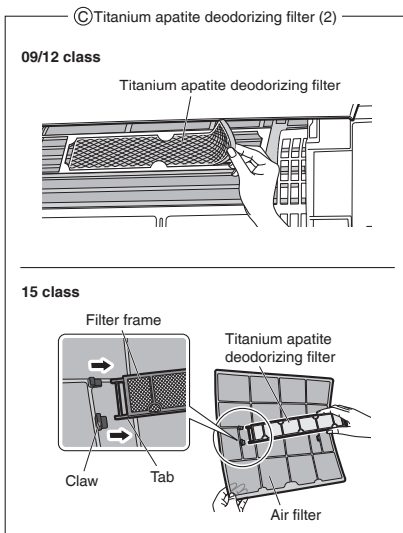
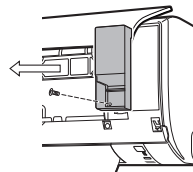

Before screwing the (E) remote controller holder to the wall, make sure that control signals are properly received by indoor unit.

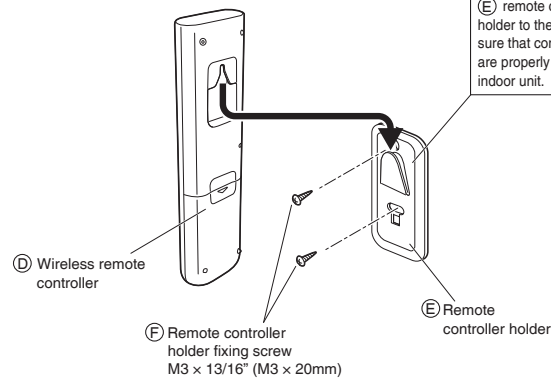

# Indoor Unit Installation

## 1. Installing the mounting plate

- The mounting plate should be installed on a wall which can support the weight of the indoor unit.
  - Temporarily secure the mounting plate to the wall, make sure that the panel is completely level, and mark the drilling points on the wall.
  - Secure the mounting plate to the wall with screws.

### Recommended mounting plate retention spots and dimensions

#### 09/12 class

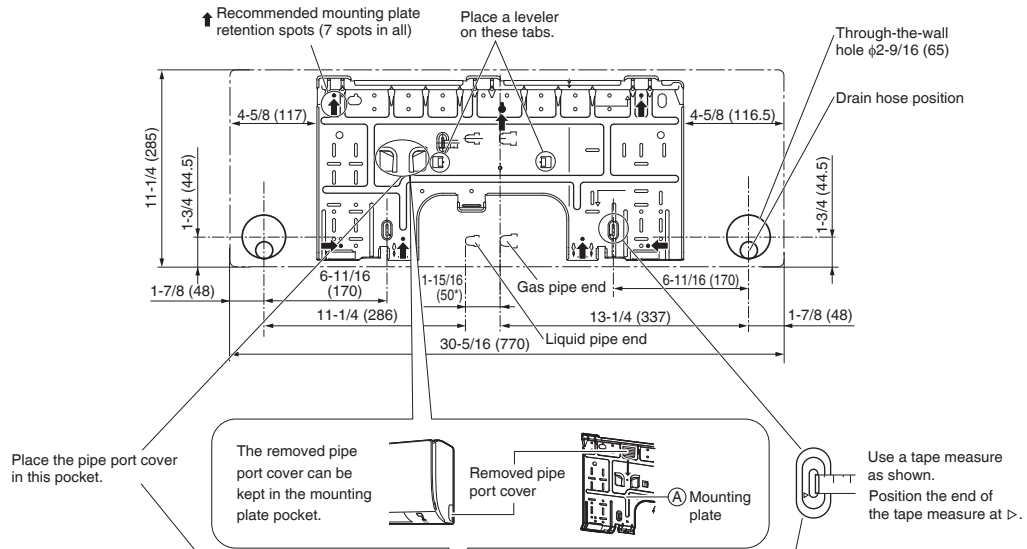

#### 15 class

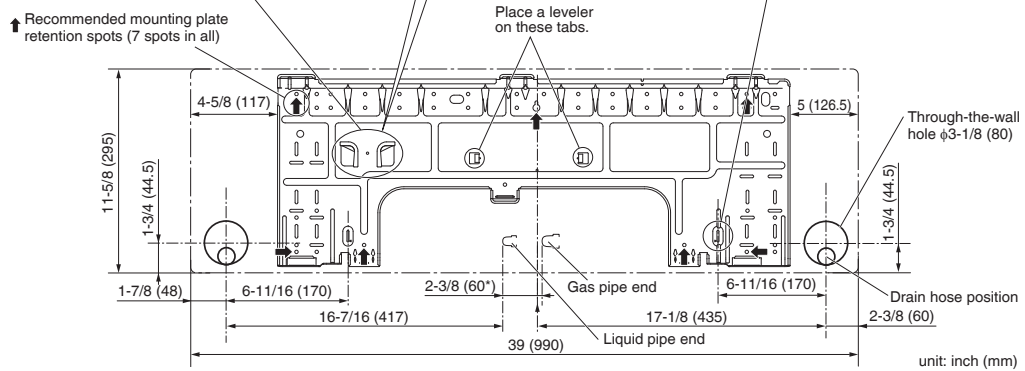

\* Depending on the model, the actual distance between the liquid pipe end and gas pipe end may differ from the distance between those symbols on the mounting plate (the distance listed in this manual). Always measure the actual distance between the liquid pipe end and gas pipe end before installing refrigerant pipes.

## 2. Drilling a wall hole and installing wall embedded pipe

### **⚠ WARNING**

For metal frame or metal board walls, be sure to use a wall embedded pipe and wall hole cover in the feed-through hole to prevent possible heat, electric shock, or fire.

- Be sure to caulk the gaps around the pipes with caulking material to prevent condensation.
- 1) Drill a feed-through hole with a  $\phi 2\text{-}9/16$  inch (65mm) (for 09/12 class),  $\phi 3\text{-}1/8$  inch (80mm) (for 15 class) diameter through the wall at a downward angle toward the outside.
- 2) Insert a wall embedded pipe into the hole.
- 3) Insert a wall hole cover into wall pipe.
- 4) After completing refrigerant piping, wiring, and drain piping, caulk the pipe hole gap with putty.

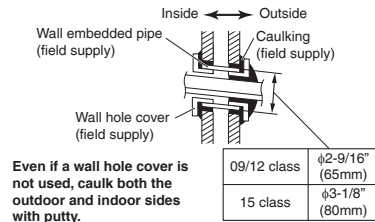

## 3. Installing the indoor unit

In the case of bending or curing refrigerant pipes, keep the following precautions in mind.

Abnormal sound may be generated if improper work is conducted.

- Do not strongly press the refrigerant pipes onto the bottom frame.
- Do not strongly press the refrigerant pipes on the front grille, either.

### 3-1. Right-side, right-back, or right-bottom piping

- 1) Attach the drain hose to the underside of the refrigerant pipes with adhesive vinyl tape.
- 2) Wrap the refrigerant pipes and drain hose together with  $\text{ⓐ}$  insulation tape.

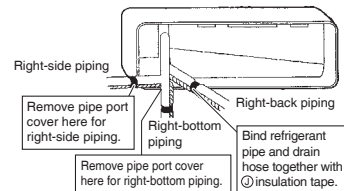

- 3) Pass the drain hose and refrigerant pipes through the wall hole, then position the indoor unit on the  $\text{Ⓐ}$  mounting plate hooks by using the  $\Delta$  markings at the top of the indoor unit as a guide.

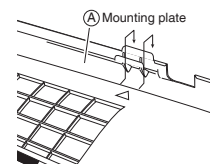

- 4) Open the front panel (Refer to "Installation Tips" on page 10), then open the service lid (Refer to "Indoor Unit Installation Diagram" on page 4).
- 5) Pass the inter-unit wire from the outdoor unit through the feed-through wall hole and pass to the front of indoor unit from the back. Then pull them at front side. Bend the ends of cable tie wires upward for easier work in advance. (If the interunit wire ends are to be stripped first, bundle wire ends with adhesive tape.)
- 6) Press the bottom frame of the indoor unit with both hands until it is firmly caught by the  $\text{Ⓐ}$  mounting plate hooks. Make sure the wire leads do not catch on the edge of the indoor unit.

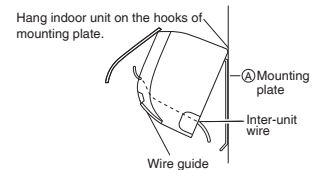

# Indoor Unit Installation

## 3-2. Left-side, left-back, or left-bottom piping

- 1) Switch around the drain plug and drain hose.

**How to switch around the drain plug and drain hose**

1) Remove the fixing screw and pull out the drain hose.

2) Pull out drain plug.

3) Switch around the drain hose and drain plug.

Push the drain plug all the way in using a hexagonal wrench (3/16 inch (4mm)).

Do not apply lubricating oil (refrigerant oil) to the drain plug when inserting it. The application of lubrication oil to the drain plug will deteriorate the plug to cause drain leakage from the plug.

Insert a hexagonal wrench (3/16 inch (4mm)).

No gap

Insert drain hose securely and fix in place with fixing screw.

- 2) Attach the drain hose to the underside of the refrigerant pipes with adhesive vinyl tape.

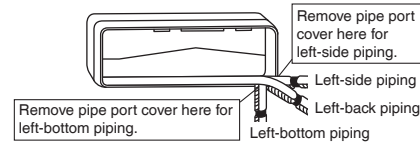

- 3) Shape the refrigerant pipes along the pipe path marking on the (A) mounting plate.

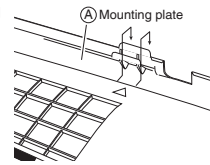

- 4) Pass the drain hose and refrigerant pipes through the wall hole, then position the indoor unit on the (A) mounting plate hooks, using the Δ markings at the top of the indoor unit as a guide.

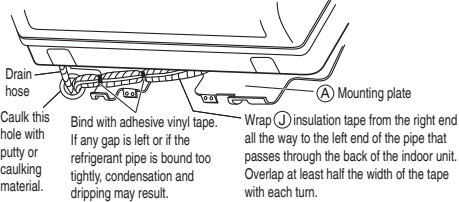

- 5) Open the front panel (Refer to "Installation Tips" on page 10), then open the service lid (Refer to "Indoor Unit Installation Diagram" on page 4).

- 6) Pass the inter-unit wire from the outdoor unit through the feed-through wall hole and pass to the front of indoor unit from the back. Then pull them at front side. Bend the ends of cable tie wires upward for easier work in advance. (If the interunit wire ends are to be stripped first, bundle wire ends with adhesive tape.)

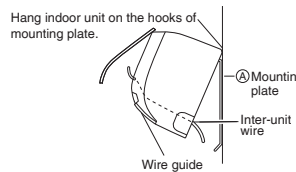

- 7) Connect the refrigerant pipes.
- 8) In case of pulling the drain hose through the back of the indoor unit, wrap the refrigerant pipes and drain hose together with (J) insulation tape as shown in the right figure.
- 9) Press the bottom frame of the indoor unit with both hands until it is firmly caught by the (A) mounting plate hooks. Make sure that the wires do not catch on the edge of the indoor unit.

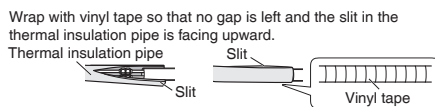
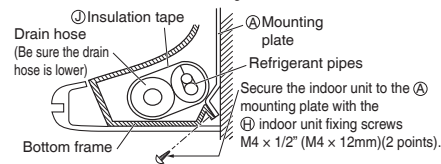

## 3-3. Wall embedded piping

Follow the instructions given under left-side, left-back, or left-bottom piping.

- 1) Insert the drain hose to a depth of 1-15/16 inches (50mm) or more so it will not be pulled out of the drain pipe.

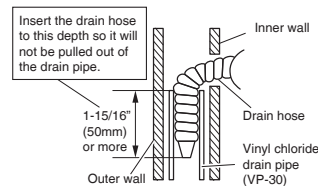

## 4. Wiring

Refer to the installation manual for the outdoor unit also.

### ⚠ WARNING

- Do not use tapped wires, extension cords, or starburst connections, as they may cause overheating, electric shock, or fire.
- Do not use locally purchased electrical parts inside the product. (Do not branch the power for the drain pump, etc., from the terminal block.) Doing so may cause electric shock or fire.
- Do not connect the power wire to the indoor unit. Doing so may cause electric shock or fire.

### ⚠ CAUTION

Recommend stranded cable for interunit wiring. Local code always supersedes recommendation.

- For stranded wires, make sure to use the round crimp-style terminal for connection to the power supply terminal block. Place the round crimp-style terminals on the wires up to the covered part and secure in place.

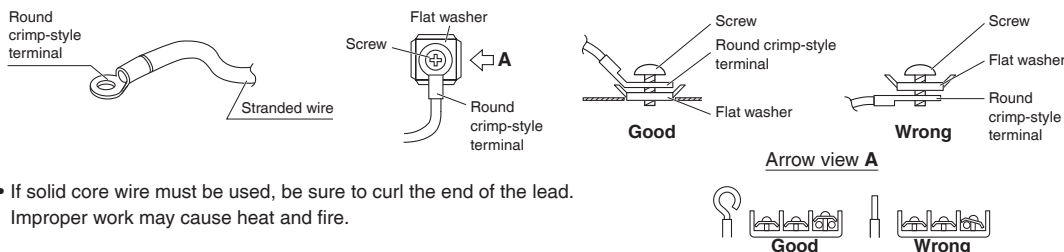

- If solid core wire must be used, be sure to curl the end of the lead. Improper work may cause heat and fire.

- 1) Remove the front grille. (Refer to “2. Removing and installing the front grille” on page 11.)
- 2) Remove the conduit mounting plate and then secure the conduit to the conduit mounting plate with the lock nut, as shown in the illustration.
- 3) Strip wire ends (3/4 inch (20mm)).
- 4) Match wire colors with terminal numbers on the indoor and outdoor unit’s terminal blocks and firmly secure the wires in the corresponding terminals with the screws.
- 5) Connect the ground wires to the corresponding terminals.
- 6) Pull the wires lightly to make sure they are securely connected.
- 7) Attach the conduit mounting plate.
- 8) Shape the wires so that the service lid fits securely.
- 9) Attach the front grille. (Refer to “2. Removing and installing the front grille” on page 11.)
- 10) Take care to ensure that all wiring between the indoor unit and the outdoor unit has a consistent connection. Any splices can cause communication errors.

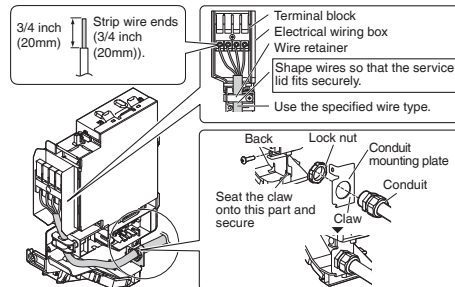

(Illustration may differ from some models)

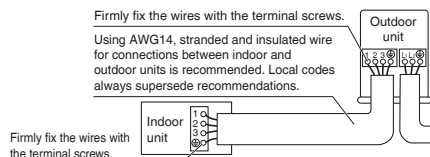

## 5. Drain piping

- 1) Connect the drain hose, as described on the right.
  - Avoid placing the end of the drain hose in a drainage location that could cause bad odors or corrosive gas to flow backward into the outlet.
  - The drainage water may change color due to bacteria or other organisms. Place in a location where the flow of drainage water will not cause a problem.
  - Minimize the number of bends in the drain hose as much as possible. If bending the drain hose, bend it gently.
- 2) Remove the air filters and transfer some water to the indoor heat exchanger by pouring water into the drain pan.
- 3) Make sure that water flows out of the drain hose.

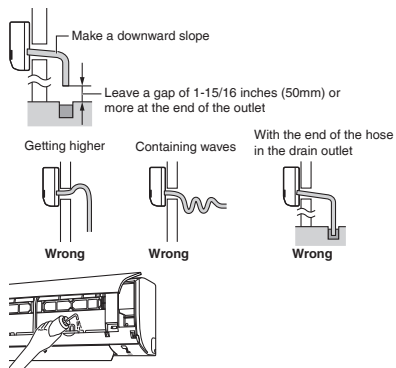



# Indoor Unit Installation

- 4) If drain hose extension or embedded drain piping is required, use appropriate parts that match the hose front end.
  - When drain hose requires extension, obtain an extension hose with an inner diameter of 5/8 inch (16mm). Be sure to thermally insulate the indoor section of the extension hose.

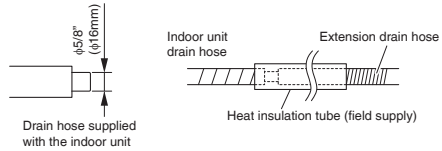

# Refrigerant Piping Work

## ⚠ WARNING

- Do not apply mineral oil to the flare.
- Prevent mineral oil from getting into the system as this would reduce the service life of the units.
- Never use piping which has been used for previous installations. Only use parts which are delivered with this unit.
- Never install a dryer to this R410A unit in order to guarantee its service life.
- The drying material may dissolve and damage the system.
- Improper flaring may result in refrigerant gas leakage.

## 1. Flaring the pipe end

- 1) Cut the pipe end with a pipe cutter.
- 2) Remove burrs with the cut surface facing downward, so that the filings do not enter the pipe.



- 3) Put the flare nut on the pipe.
- 4) Flare the pipe.
- 5) Check that the flaring has been done correctly.

Flaring

Set exactly at the position shown below.

Flare tool for R410A	Conventional flare tool		
	Clutch-type	Clutch-type (Rigid-type)	Wing-nut type (Imperial-type)
A	0-0.020 inch (0-0.5mm)	0.039-0.059 inch (1.0-1.5mm)	0.059-0.079 inch (1.5-2.0mm)

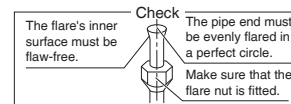

## 2. Refrigerant piping

### ⚠ CAUTION

- Use the flare nut fixed to the main unit. (This is to prevent the flare nut from cracking as a result of deterioration over time.)
  - To prevent gas leakage, apply refrigeration oil only to the inner surface of the flare. (Use refrigeration oil for R410A.)
  - Use a torque wrench when tightening the flare nuts to prevent damage to the flare nuts and gas leakage.
- Align the centers of both flares and tighten the flare nuts 3 or 4 turns by hand, then tighten them fully with a spanner and a torque wrench.

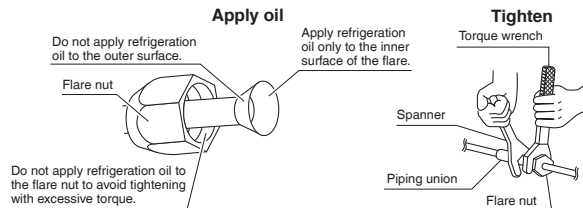

	Piping size	Flare nut tightening torque
Gas side	O.D. 3/8 inch (9.5mm)	24-1/8 – 29-1/2 lbf • ft (32.7-39.9 N • m)
	O.D. 1/2 inch (12.7mm)	36-1/2 – 44-1/2 lbf • ft (49.5-60.3 N • m)
	O.D. 5/8 inch (15.9mm)	45-5/8 – 55-5/8 lbf • ft (61.8-75.4 N • m)
Liquid side	O.D. 1/4 inch (6.4mm)	10-1/2 – 12-3/4 lbf • ft (14.2-17.2 N • m)

### Caution on piping handling

- Protect the open end of the pipe against dust and moisture.
- All pipe bends should be as gentle as possible. Use a pipe bender for bending.

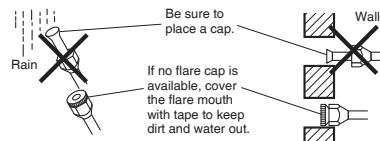



### Selection of copper and heat insulation materials

When using commercial copper pipes and fittings, observe the following:

- Insulation material: Polyethylene foam  
Heat transfer rate: 0.041 to 0.052W/mK (0.024 to 0.030Btu/ft<sup>2</sup>°F (0.035 to 0.045kcal/mh°C))  
Be sure to use insulation that is designed for use with HVAC Systems.
- ACR Copper only.

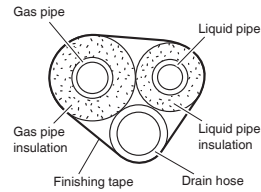

- Be sure to insulate both the gas and liquid piping and observe the insulation dimensions as below.

	Piping size	Minimum bend radius	Piping thickness	Thermal insulation size	Thermal insulation thickness
Gas side	O.D. 3/8 inch (9.5mm)	1-3/16 inch (30mm) or more	0.031 inch (0.8mm) (C1220T-O)	I.D. 15/32-19/32 inch (12-15mm)	13/32 inch (10mm) Min.
	O.D. 1/2 inch (12.7mm)	1-9/16 inch (40mm) or more		I.D. 9/16-5/8 inch (14-16mm)	
	O.D. 5/8 inch (15.9mm)	1-15/16 inch (50mm) or more	0.039 inch (1.0mm) (C1220T-O)	I.D. 5/8-13/16 inch (16-20mm)	
Liquid side	O.D. 1/4 inch (6.4mm)	1-3/16 inch (30mm) or more	0.031 inch (0.8mm) (C1220T-O)	I.D. 5/16-13/32 inch (8-10mm)	

- Use separate thermal insulation pipes for gas and liquid refrigerant pipes.
- Using finishing tape, bundle and wrap the indoor unit piping and drain hose together so that the drain hose is below the other piping.

## Installation Tips

### 1. Removing and installing the front panel

• **Removal method**

- 1) Place your fingers in the indentations on the main unit (one each on the left and right sides), and open the front panel until it stops.

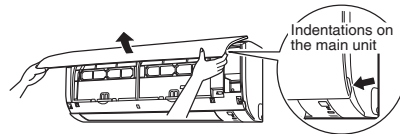

- 2) While pushing the left side front panel shaft outward, push up the front panel and remove it. (Remove the right side front panel shaft in the same manner.)
- 3) After removing both front panel shafts, pull the front panel toward yourself and remove it.

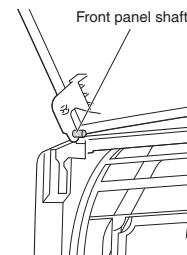

• **Installation method**

- Align the front panel shaft of the front panel with the grooves of grille, and push all the way in, then close slowly.  
Push the center of the lower panel surface firmly to engage the tabs.

# Installation Tips

## 2. Removing and installing the front grille

**• Removal method**

- 1) Remove the front panel and air filters.
- 2) Remove the 2 screws from the front grille.  
(The 15 class model has 3 screws.)
- 3) In front of the ○○○ mark on the front grille, there are 3 upper hooks. Lightly pull the front grille toward you with one hand, and push down on the hooks with the fingers of your other hand.

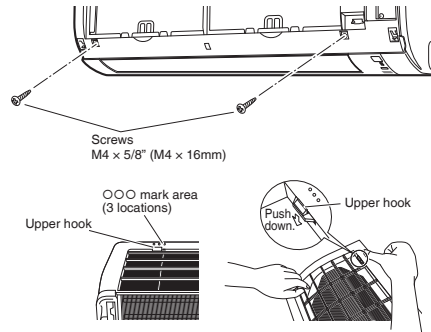

**When there is insufficient work space because the unit is close to ceiling**

**⚠ CAUTION** \_\_\_\_\_  
Be sure to wear protection gloves.

Place both hands under the center of the front grille, and while pushing up, pull it toward you.

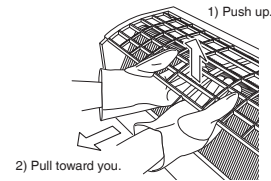

**• Installation method**

- 1) Install the front grille and firmly engage the upper hooks (3 locations).
- 2) Install 2 screws of the front grille.  
(The 15 class model has 3 screws.)
- 3) Install the air filters and then mount the front panel.

## 3. How to set the different addresses

When 2 indoor units are installed in one room, the 2 wireless remote controllers can be set for different addresses. Change the address setting of one of the 2 units. When cutting the jumper, be careful not to damage any of the surrounding parts.

- 1) Remove the battery cover on the remote controller and cut the address jumper.
- 2) Press **TEMP F/C**, **TEMP F/C** and **OFF** at the same time.
- 3) Press **TEMP F/C**, then select **1**, press **FAN**.  
(The indoor unit OPERATION lamp will blink for about 1 minute.)
- 4) Press the indoor unit ON/OFF switch while the OPERATION lamp is blinking.

Remove the batteries before cutting the jumper.

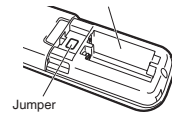

	Address	
	1	2
Jumper	EXIST	CUT



- If setting could not be carried out completely while the OPERATION lamp was blinking, carry out the setting process once again from the beginning.
- After setting is complete, pressing **FAN** for about 5 seconds will cause the remote controller to return to the previous display.

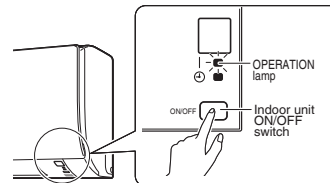

# Trial Operation and Testing

## 1. Trial operation and testing

- Trial operation should be carried out in either COOL or HEAT operation.

**1-1. Measure the supply voltage and make sure that it is within the specified range.**

**1-2. In COOL operation, select the lowest programmable temperature; in HEAT operation, select the highest programmable temperature.**

**1-3. Carry out the trial operation following the instructions in the operation manual to ensure that all functions and parts, such as the movement of the flap, are working properly.**

- To protect the air conditioner, restart operation is disabled for 3 minutes after the system has been turned off.

**1-4. After trial operation is complete, set the temperature to a normal level (78°F to 82°F (26°C to 28°C) in COOL operation, 68°F to 75°F (20°C to 24°C) in HEAT operation).**

- When operating the air conditioner in COOL operation in winter, or HEAT operation in summer, set it to the trial operation mode using the following method.

1) Press ,  and  at the same time.

2) Press , then select **7**, press .

3) Press  or  to turn on the system.

- Trial operation will stop automatically after about 30 minutes.

To stop the operation, press .

- Some of the functions cannot be used in the trial operation mode.



- The air conditioner draws a small amount of power in its standby mode. If the system is not to be used for some time after installation, shut off the circuit breaker to eliminate unnecessary power consumption.
- If the circuit breaker trips to shut off the power to the air conditioner, the system will restore the original operation mode when the circuit breaker is turned on again.

## 2. Test items

Test items	Symptom	Check
Indoor and outdoor units are installed securely.	Fall, vibration, noise	
No refrigerant gas leaks.	Incomplete cooling/heating function	
Refrigerant gas and liquid pipes and indoor drain hose extension are thermally insulated.	Water leakage	
Draining line is properly installed.	Water leakage	
System is properly grounded.	Electrical leakage	
Only specified wires are used for all wiring, and all wires are connected correctly.	No operation or burn damage	
Indoor or outdoor unit's air inlet or air outlet are unobstructed.	Incomplete cooling/heating function	
Stop valves are opened.	Incomplete cooling/heating function	
Indoor unit properly receives remote control commands.	No operation	

12.2 FTX18/24

# Contents

<b>Safety Considerations .....</b>	<b>1</b>	<b>Refrigerant Piping Work .....</b>	<b>9</b>
<b>Accessories .....</b>	<b>3</b>	1. Flaring the pipe end .....	9
<b>Choosing an Installation Site .....</b>	<b>3</b>	2. Refrigerant piping.....	9
1. Indoor unit.....	3	<b>Installation Tips .....</b>	<b>10</b>
2. Wireless remote controller .....	3	1. Removing and installing the front panel.....	10
<b>Indoor Unit Installation Diagram .....</b>	<b>4</b>	2. Removing and installing the front grille.....	10
<b>Indoor Unit Installation .....</b>	<b>5</b>	3. How to set the different addresses .....	11
1. Installing the mounting plate .....	5	4. When connecting to an HA system.....	11
2. Drilling a wall hole and installing wall embedded pipe ...	5	<b>Trial Operation and Testing .....</b>	<b>12</b>
3. Installing the indoor unit.....	5	1. Trial operation and testing .....	12
4. Wiring.....	7	2. Test items .....	12
5. Drain piping.....	8		

The pictures in this document are for illustrative purposes only.

# Safety Considerations

Refer also to the General Safety Considerations in the separate booklet.

**Read the precautions in this manual carefully before operating the unit.**

Read these **Safety Considerations for Installation** carefully before installing an air conditioner or heat pump. After completing the installation, make sure that the unit operates properly during the startup operation.

Instruct the user on how to operate and maintain the unit. Inform users that they should store this installation manual with the operation manual for future reference.

Always use a licensed installer or contractor to install this product. Improper installation can result in water or refrigerant leakage, electric shock, fire, or explosion.

Meanings of **DANGER**, **WARNING**, **CAUTION**, and **NOTE** Symbols:

- DANGER** .....Indicates an imminently hazardous situation which, if not avoided, will result in death or serious injury.
- WARNING** .....Indicates a potentially hazardous situation which, if not avoided, could result in death or serious injury.
- CAUTION** .....Indicates a potentially hazardous situation which, if not avoided, may result in minor or moderate injury. It may also be used to alert against unsafe practices.
- NOTE** .....Indicates situations that may result in equipment or property damage accidents only.

## **DANGER**

- Refrigerant gas is heavier than air and replaces oxygen. A massive leak can lead to oxygen depletion, especially in basements, and an asphyxiation hazard could occur leading to serious injury or death.
- Do not ground units to water pipes, gas pipes, telephone wires, or lightning rods as incomplete grounding can cause a severe shock hazard resulting in severe injury or death. Additionally, grounding to gas pipes could cause a gas leak and potential explosion causing severe injury or death.

- If refrigerant gas leaks during installation, ventilate the area immediately. Refrigerant gas may produce toxic gas if it comes into contact with fire. Exposure to this gas could cause severe injury or death.
- After completing the installation work, check that the refrigerant gas does not leak throughout the system.
- Do not install unit in an area where flammable materials are present due to risk of explosions that can cause serious injury or death.
- Safely dispose all packing and transportation materials in accordance with federal/state/local laws or ordinances. Packing materials such as nails and other metal or wood parts, including plastic packing materials used for transportation may cause injuries or death by suffocation.

## **WARNING**

- Only qualified personnel licensed or certified in their jurisdiction must carry out the installation work. Installation must be done in accordance with this installation manual. Improper installation may result in water leakage, electric shock, or fire.
- When installing the unit in a small room, take measures to keep the refrigerant concentration from exceeding allowable safety limits. Excessive refrigerant leaks, in the event of an accident in a closed ambient space, can lead to oxygen deficiency.
- Use only specified accessories and parts for installation work. Failure to use specified parts may result in water leakage, electric shock, fire, or the unit falling.
- Install the air conditioner or heat pump on a foundation strong enough that it can withstand the weight of the unit. A foundation of insufficient strength may result in the unit falling and causing injuries.
- Take into account strong winds, typhoons, or earthquakes when installing. Improper installation may result in the unit falling and causing accidents.
- Make sure that a separate power supply circuit is provided for this unit and that all electrical work is carried out by qualified personnel licensed or certified in their jurisdiction according to local, state, and national regulations. An insufficient power supply capacity or improper electrical construction may lead to electric shock or fire.
- Make sure that all wiring is secured, that specified wires are used, and that no external forces act on the terminal connections or wires. Improper connections or installation may result in fire.

- When wiring, position the wires so that the electrical wiring box cover can be securely fastened. Improper positioning of the electrical wiring box cover may result in electric shock, fire, or the terminals overheating.
- Before touching electrical parts, turn off the unit.
- The circuit must be protected with safety devices in accordance with local and national codes, i.e. a circuit breaker.
- Securely fasten the outdoor unit terminal cover (panel). If the terminal cover/panel is not installed properly, dust or water may enter the outdoor unit causing fire or electric shock.
- When installing or relocating the system, keep the refrigerant circuit free from substances other than the specified refrigerant (R410A) such as air. Any presence of air or other foreign substance in the refrigerant circuit can cause an abnormal pressure rise or rupture, resulting in equipment damage and even injury.
- Do not change the setting of the protection devices. If the pressure switch, thermal switch, or other protection device is shorted and operated forcibly, or parts other than those specified by Daikin are used, fire or explosion may occur.
- Do not use means to accelerate the defrosting process (if possible) or to clean, other than those recommended by the manufacturer.
- The appliance must be stored in a room without continuously operating ignition sources (for example: open flames, an operating gas appliance or an operating electric heater).
- Do not pierce or burn.
- Be aware that refrigerants may not contain an odor.
- Comply with national gas regulations.

**⚠ CAUTION**

- Do not touch the switch with wet fingers. Touching a switch with wet fingers can cause electric shock.
- Do not allow children to play on or around the unit to prevent injury.
- Wear adequate personal protective equipment (protective gloves, safety glasses,...) when installing, maintaining or servicing the system.
- The heat exchanger fins are sharp enough to cut. To avoid injury, wear gloves or cover the fins while working around them.
- Do not touch the refrigerant pipes during and immediately after operation as the refrigerant pipes may be hot or cold, depending on the condition of the refrigerant flowing through the refrigerant piping, compressor, and other refrigerant cycle parts. Your hands may suffer burns or frostbite if you touch the refrigerant pipes. To avoid injury, give the pipes time to return to normal temperature or, if you must touch them, be sure to wear proper gloves.
- Install drain piping to ensure proper drainage. Improper drain piping may result in water leakage and property damage.
- Insulate piping to prevent condensation.
- Be careful when transporting the product.
- Do not turn off the power immediately after stopping operation. Always wait for at least 5 minutes before turning off the power. Otherwise, water leakage may occur.
- Do not use a charging cylinder. Using a charging cylinder may cause the refrigerant to deteriorate.
- Refrigerant R410A in the system must be kept clean, dry, and tight.

(a) Clean and Dry -- Foreign materials (including mineral oils such as SUNISO oil or moisture) should be prevented from getting into the system.







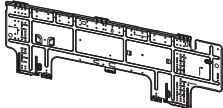

- (b) Tight -- R410A does not contain any chlorine, does not destroy the ozone layer, and does not reduce the earth's protection against harmful ultraviolet radiation. R410A can contribute to the greenhouse effect if it is released. Therefore take proper measures to check for the tightness of the refrigerant piping installation. Read the chapter *Refrigerant Piping Work* and follow the procedures.
- Since R410A is a blend, the required additional refrigerant must be charged in its liquid state. If the refrigerant is charged in a state of gas, its composition can change and the system will not work properly.
- The indoor unit is for R410A. See the catalog for outdoor models that can be connected. Normal operation is not possible when connected to non-compatible outdoor units.
- Remote controller (wireless kit) transmitting distance can be shorter than expected in rooms with electronic fluorescent lamps (inverter or rapid start types). Install the indoor unit far away from fluorescent lamps as much as possible.
- Indoor units are for indoor installation only. Outdoor units can be installed either outdoors or indoors.
- Do not install the air conditioner or heat pump in the following locations:
  - (a) Where a mineral oil mist or oil spray or vapor is produced, for example, in a kitchen. Plastic parts may deteriorate and fall off or result in water leakage.
  - (b) Where corrosive gas, such as sulfurous acid gas, is produced. Corroding copper pipes or soldered parts may result in refrigerant leakage.
  - (c) Near machinery emitting electromagnetic waves. Electromagnetic waves may disturb the operation of the control system and cause the unit to malfunction.
  - (d) Where flammable gas may leak, where there is carbon fiber, or ignitable dust suspension in the air, or where volatile flammables such as thinner or gasoline are handled. Operating the unit in such conditions can cause a fire.
- Take adequate measures to prevent the outdoor unit from being used as a shelter by small animals. Small animals making contact with electrical parts can cause malfunctions, smoke, or fire. Instruct the user to keep the area around the unit clean.
- Servicing shall be performed only as recommended by the manufacturer and licensed or certified in their jurisdiction.

**⚠ NOTE**

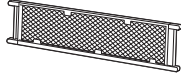
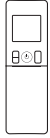
- The indoor unit should be positioned where the unit and inter-unit wires (outdoor to indoor) are at least 3.3ft (1m) away from any televisions or radios. (The unit may cause interference with the picture or sound.) Depending on the radio waves, a distance of 3.3ft (1m) may not be sufficient to eliminate the noise.
- Dismantling the unit, treatment of the refrigerant, oil and additional parts must be done in accordance with the relevant local, state, and national regulations.
- Only use tools for R410A, such as a gauge manifold, charge hose, gas leak detector, reverse flow check valve, refrigerant charge base, vacuum gauge, or refrigerant recovery equipment.
- If the conventional refrigerant and refrigerant oil are mixed in R410A, the refrigerant may deteriorate.
- This air conditioner or heat pump is an appliance that should not be accessible to the general public.
- As maximum allowable pressure is 604psi (4.17MPa), the wall thickness of field-installed pipes should be selected in accordance with the relevant local, state, and national regulations.

FTN005-U

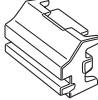
# Accessories

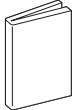
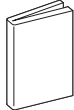
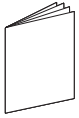
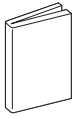
<p><b>(A)</b> Mounting plate</p>  <p>1</p>	<p><b>(B)</b> Mounting plate fixing screw M4 × 1" (M4 × 25mm)</p>  <p>9</p>	<p><b>(C)</b> Titanium apatite deodorizing filter</p>  <p>2</p>
<p><b>(D)</b> Wireless remote controller</p>  <p>1</p>	<p><b>(E)</b> Remote controller holder</p>  <p>1</p>	<p><b>(F)</b> Remote controller holder fixing screw M3 × 13/16" (M3 × 20mm)</p>  <p>2</p>
<p><b>(G)</b> Dry battery AAA. LR03 (alkaline)</p>  <p>2</p>	<p><b>(H)</b> Indoor unit fixing screw M4 × 1/2" (M4 × 12mm)</p>  <p>2</p>	<p><b>(J)</b> Screw cover</p>  <p>3</p>
<p><b>(K)</b> Tube</p>  <p>1</p>	<p><b>(L)</b> Operation manual</p>  <p>1</p>	<p><b>(M)</b> Installation manual</p>  <p>1</p>
<p><b>(N)</b> Warranty</p>  <p>1</p>	<p><b>(P)</b> General safety considerations</p>  <p>1</p>	

# Choosing an Installation Site

- Before choosing the installation site, obtain user approval.

## 1. Indoor unit

- The indoor unit should be positioned in a place where:
  - 1) the restrictions on the installation requirements specified in “**Indoor Unit Installation Diagram**” on page 4 are met,
  - 2) both the air inlet and air outlet are unobstructed,
  - 3) the unit is not exposed to direct sunlight,
  - 4) Install so that drainage occurs easily,
  - 5) the unit is away from sources of heat or steam,
  - 6) there is no source of machine oil vapor (this may shorten the indoor unit service life),
  - 7) cool/warm air is circulated throughout the room,
  - 8) the unit is away from electronic ignition type fluorescent lamps (inverter or rapid start type) as they may affect the remote controller range,
  - 9) the unit is at least 3.3ft (1m) away from any television or radio set (the unit may cause interference with the picture or sound),
  - 10) no laundry equipment is nearby.

## 2. Wireless remote controller

- Turn on all the fluorescent lamps in the room, if any, and find a location where the remote controller signals are properly received by the indoor unit (within 23ft (7m)).

# Indoor Unit Installation Diagram

## ⚠ CAUTION

- Do not hit or violently push the INTELLIGENT EYE sensor. This can lead to damage and malfunction.
- Do not place large objects near the INTELLIGENT EYE sensor. Also keep heating units or humidifiers outside the sensor's detection area.

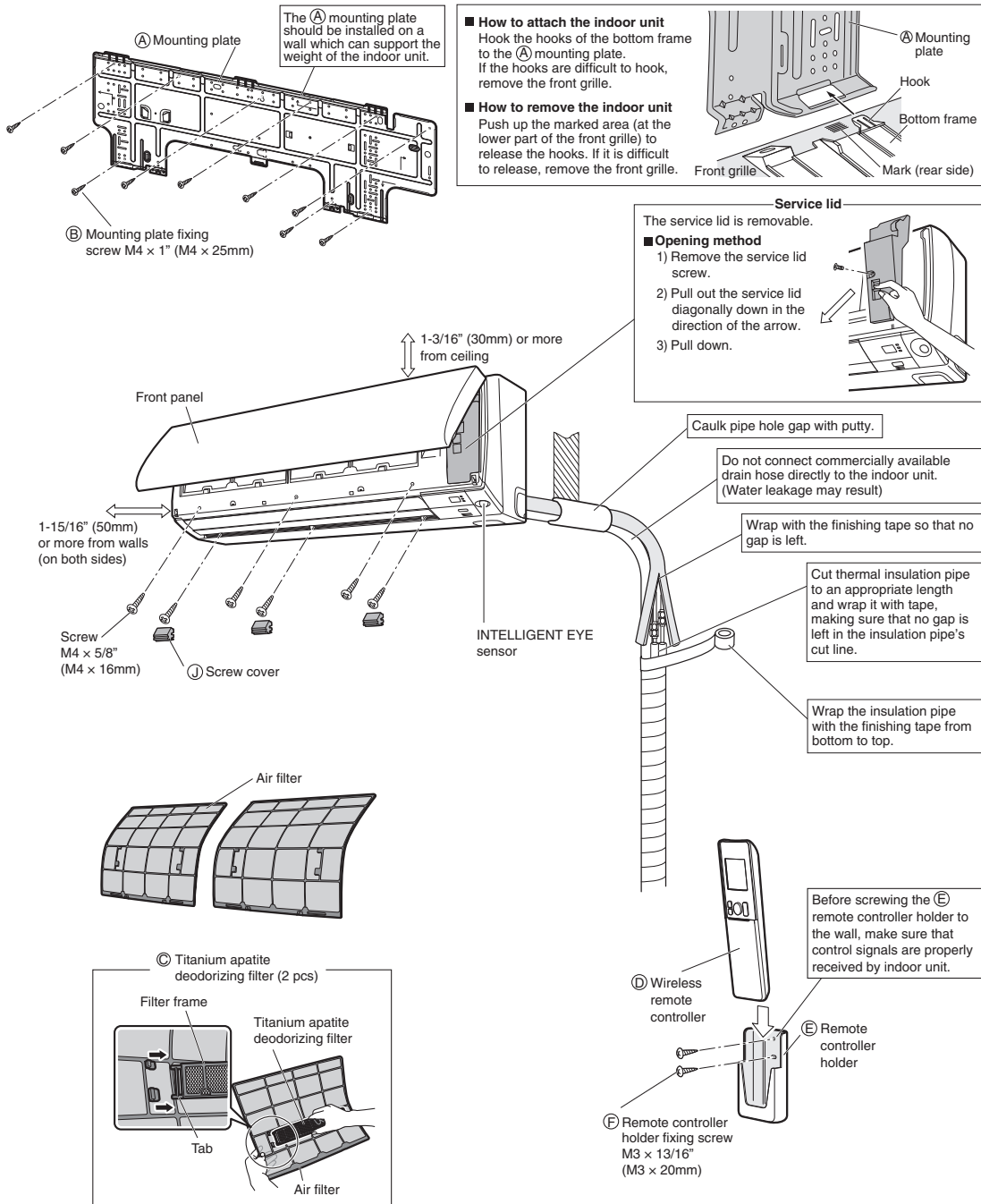



# Indoor Unit Installation

## 1. Installing the mounting plate

The mounting plate should be installed on a wall which can support the weight of the indoor unit.

- 1) Temporarily secure the mounting plate to the wall, make sure that the plate is completely level, and mark the drilling points on the wall.
- 2) Secure the mounting plate to the wall with screws.

### Recommended mounting plate retention spots and dimensions

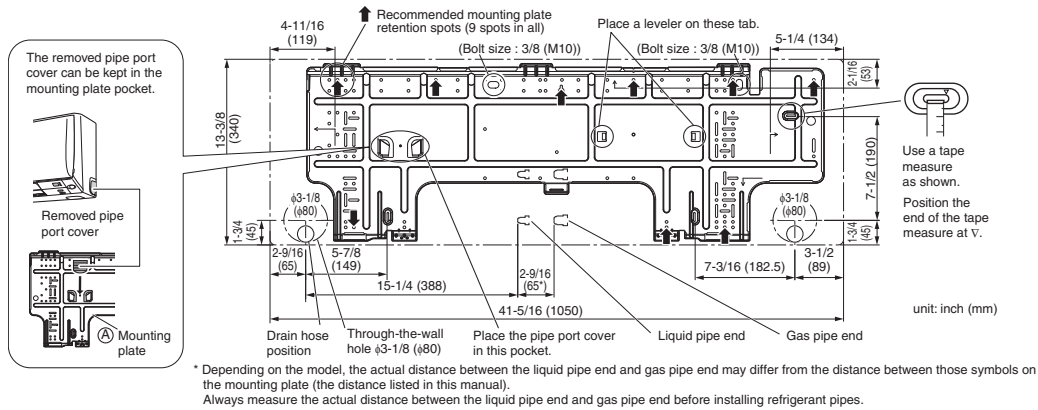

## 2. Drilling a wall hole and installing wall embedded pipe

### ⚠ WARNING

For metal frame or metal board walls, be sure to use a wall embedded pipe and wall hole cover in the feed-through hole to prevent possible heat, electric shock, or fire.

- Be sure to caulk the gaps around the pipes with caulking material. (to prevent condensation caused by intrusion of air from outside or within the wall)
  - 1) Drill a feed-through hole with a  $\phi 3-1/8$  inch (80mm) diameter through the wall at a downward angle toward the outside. (to prevent water leakage)
  - 2) Insert a wall embedded pipe into the hole.
  - 3) Insert a wall hole cover into wall pipe.
  - 4) After completing refrigerant piping, wiring, and drain piping, caulk the pipe hole gap with putty.

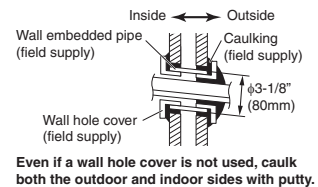

## 3. Installing the indoor unit

In the case of bending or curing refrigerant pipes, keep the following precautions in mind. Abnormal sound may be generated if improper work is conducted.

- Do not strongly press the refrigerant pipes onto the bottom frame.
- Do not strongly press the refrigerant pipes on the front grille, either.

### 3-1. Right-side, right-back, or right-bottom piping

- 1) Attach the drain hose to the underside of the refrigerant pipes with adhesive vinyl tape.
- 2) Wrap the refrigerant pipes and drain hose together with an insulation tape.
- 3) Pass the drain hose and refrigerant pipes through the wall hole, then position the indoor unit on the (A) mounting plate hooks, using the  $\Delta$  markings at the top of the indoor unit as a guide.
- 4) Open the front panel, then open the service lid. (Refer to "Service lid" on page 4.)
- 5) Pass the inter-unit wire from the outdoor unit through the feed-through wall hole and then through the back of the indoor unit. Pull them through the front side. Bend the ends of cable tie wires upward for easier work in advance. (If the inter-unit wire ends are to be stripped first, bundle wire ends with adhesive tape.)
- 6) Press the bottom frame of the indoor unit with both hands until it is firmly caught by the (A) mounting plate hooks. Make sure that the wires do not catch on the edge of the indoor unit.

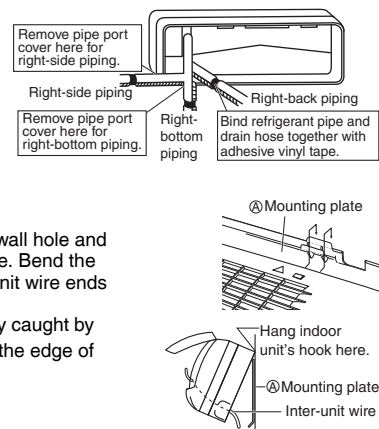



### 3-2. Left-side, left-back, or left-bottom piping

**How to switch around the drain plug and drain hose**

1) Remove the fixing screw and pull out the drain hose.

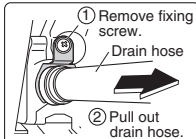

① Remove fixing screw.  
Drain hose

② Pull out drain hose.

3) Switch around the drain hose and drain plug.

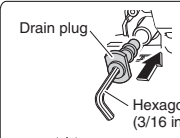

Drain plug  
Hexagonal wrench (3/16 inch (4mm))

Push the drain plug all the way in using a hexagonal wrench (3/16 inch (4mm)).

No gap

Do not apply lubricating oil (refrigerant oil) to the drain plug when inserting it. The application of lubrication oil to the drain plug will deteriorate the plug to cause drain leakage from the plug.

Insert a hexagonal wrench (3/16 inch (4mm)).

Insert drain hose securely and fix in place with fixing screw.

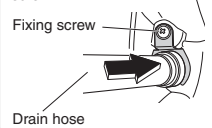

Fixing screw  
Drain hose

2) Pull out drain plug.

- 1) Switch around the drain plug and drain hose.
- 2) Attach the drain hose to the underside of the refrigerant pipes with adhesive vinyl tape.
- 3) Shape the refrigerant pipes along the pipe path marking on the (A) mounting plate.
- 4) Pass the drain hose and refrigerant pipes through the wall hole, then position the indoor unit on the (A) mounting plate hooks, using the  $\Delta$  markings at the top of the indoor unit as a guide.
- 5) Open the front panel, then open the service lid. (Refer to "Service lid" on page 4.)
- 6) Pass the inter-unit wire from the outdoor unit through the feed-through wall hole and then through the back of the indoor unit. Pull them through the front side. Bend the ends of the wires upward for easier work in advance. (If the inter-unit wire ends are to be stripped first, bundle wire ends with adhesive tape.)
- 7) Connect the refrigerant pipes.
- 8) In case of pulling the drain hose through the back of the indoor unit, wrap the refrigerant pipes and drain hose together with insulation tape as shown in the figure.
- 9) Press the bottom frame of the indoor unit with both hands until it is firmly caught by the (A) mounting plate hooks. Make sure that the wires do not catch on the edge of the indoor unit.

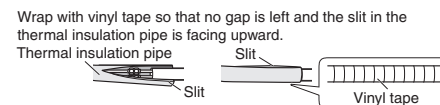
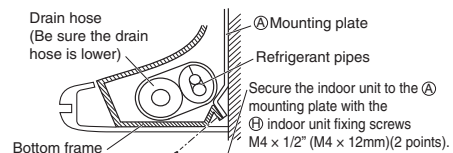
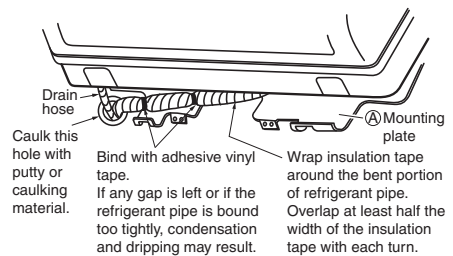
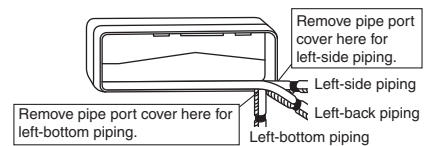

### 3-3. Wall embedded piping

Follow the instructions given under left-side, left-back, or left-bottom piping.

- 1) Insert the drain hose to a depth of 50mm or more so it will not be pulled out of the drain pipe.

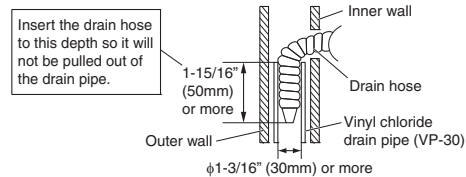

# Indoor Unit Installation

## 4. Wiring

Refer to the installation manual for the outdoor unit also.

### ⚠ WARNING

- Do not use tapped wires, extension cords, or starburst connections, as they may cause overheating, electric shock, or fire.
- Do not use locally purchased electrical parts inside the product. (Do not branch the power for the drain pump, etc., from the terminal block.) Doing so may cause electric shock or fire.
- Do not connect the power wire to the indoor unit. Doing so may cause electric shock or fire.

### ⚠ CAUTION

Recommend stranded cable for interunit wiring. Local code always supersedes recommendation.

- For stranded wires, make sure to use the round crimp-style terminal for connection to the power supply terminal block. Place the round crimp-style terminals on the wires up to the covered part and secure in place.

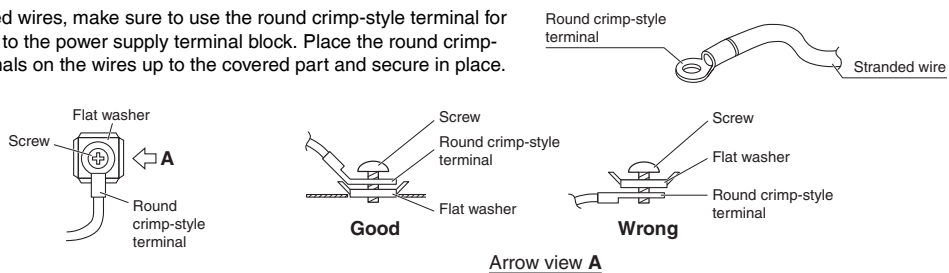

- If solid core wire must be used, be sure to curl the end of the lead. Improper work may cause heat and fire.

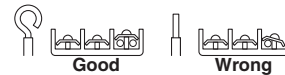

- 1) Remove the front grille. (Refer to “2. Removing and installing the front grille” on page 10.)
- 2) Remove the conduit mounting plate and then secure the conduit to the conduit mounting plate with the lock nut, as shown in the illustration.
- 3) Insert the wires including the ground wire into (K) tube.
- 4) Strip wire ends (3/4 inch (20mm)).
- 5) Match wire colors with terminal numbers on the indoor and outdoor unit’s terminal blocks and firmly secure the wires in the corresponding terminals with the screws.
- 6) Connect the ground wires to the corresponding terminals.
- 7) Pull the wires lightly to make sure they are securely connected.
- 8) In case of connecting to an adapter system, run the remote controller cable and attach the S21. (Refer to “4. When connecting to an HA system” on page 11.)
- 9) Attach the conduit mounting plate.
- 10) Shape the wires so that the service lid fits securely.
- 11) Attach the front grille. (Refer to “2. Removing and installing the front grille” on page 10.)
- 12) Take care to ensure that all wiring between the indoor unit and the outdoor unit has a consistent connection. Any splices can cause communication errors.

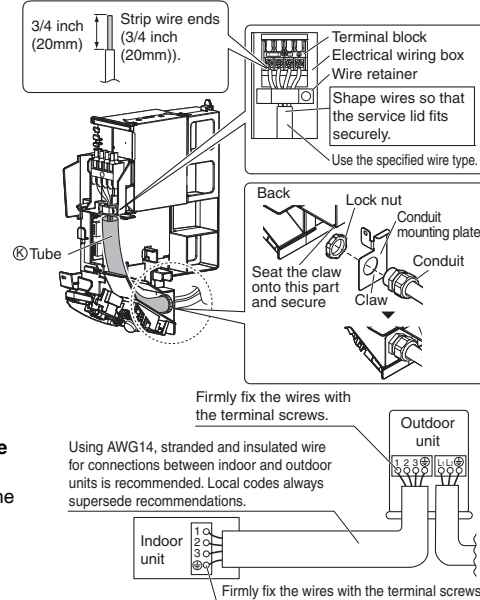

## 5. Drain piping

- 1) Connect the drain hose, as described on the right.
  - Avoid placing the end of the drain hose in a drainage location that could cause bad odours or corrosive gas to flow backward into the outlet.
  - The drainage water may change color due to bacteria or other organisms. Place in a location where the flow of drainage water will not cause a problem.
  - Minimize the number of bends in the drain hose as much as possible. If bending the drain hose, bend it gently.
- 2) Remove the air filters and transfer some water to the indoor heat exchanger by pouring water into the drain pan.
- 3) Make sure that water flows out of the drain hose.

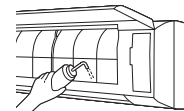
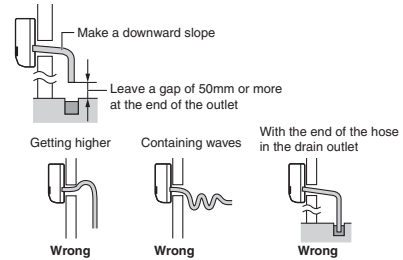

- When drain hose requires extension, obtain an extension hose with an inner diameter of 5/8 inch (16mm). Be sure to thermally insulate the indoor section of the extension hose.

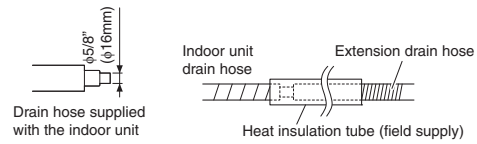

- When connecting a rigid polyvinyl chloride pipe (nominal diameter 1/2 inch (13mm)) directly to the drain hose attached to the indoor unit as with embedded piping work, use any commercially available drain socket (nominal diameter 1/2 inch (13mm)) as a joint.

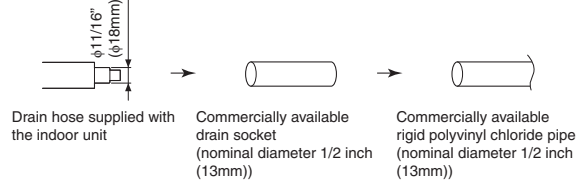

# Refrigerant Piping Work

## ⚠ WARNING

- Do not apply mineral oil on flared part.
- Prevent mineral oil from getting into the system as this would reduce the service life of the units.
- Never use piping which has been used for previous installations. Only use parts which are delivered with this unit.
- Never install a dryer to this R410A unit in order to guarantee its service life.
- The drying material may dissolve and damage the system.
- Incomplete flaring may result in refrigerant gas leakage.

## 1. Flaring the pipe end

- 1) Cut the pipe end with a pipe cutter.
- 2) Remove burrs with the cut surface facing downward, so that the filings do not enter the pipe.



- 3) Put the flare nut on the pipe.
- 4) Flare the pipe.
- 5) Check that the flaring has been done correctly.

Flaring

Set exactly at the position shown below.

	Flare tool for R410A	Conventional flare tool	
	Clutch-type	Clutch-type (Rigid-type)	Wing-nut type (Imperial-type)
A	0-0.020 inch (0-0.5mm)	0.039-0.059 inch (1.0-1.5mm)	0.059-0.079 inch (1.5-2.0mm)

Check

The flare's inner surface must be flaw-free.

When flaring, do not over-tighten and crack.

The pipe end must be evenly flared in a perfect circle.

Make sure that the flare nut is fitted.

## 2. Refrigerant piping

### ⚠ CAUTION

- Use the flare nut fixed to the main unit. (This is to prevent the flare nut from cracking as a result of deterioration over time.)
  - To prevent gas leakage, apply refrigeration oil only to the inner surface of the flare. (Use refrigeration oil for R410A.)
  - Use a torque wrench when tightening the flare nuts to prevent damage to the flare nuts and gas leakage.
- Align the centers of both flares and tighten the flare nuts 3 or 4 turns by hand, then tighten them fully with a spanner and a torque wrench.

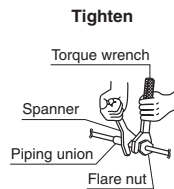
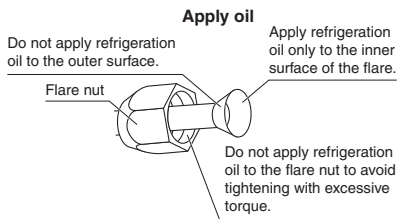

	Piping size	Flare nut tightening torque
Gas side	O.D. 1/2 inch (12.7mm)	36-1/2-44-1/2ft • lbf (49.5-60.3N • m)
	O.D. 5/8 inch (15.9mm)	45-5/8-55-5/8ft • lbf (61.8-75.4N • m)
Liquid side	O.D. 1/4 inch (6.4mm)	10-1/2-12-3/4ft • lbf (14.2-17.2N • m)

### Caution on piping handling

- Protect the open end of the pipe against dust and moisture.
- All pipe bends should be as gentle as possible. Use a pipe bender for bending.

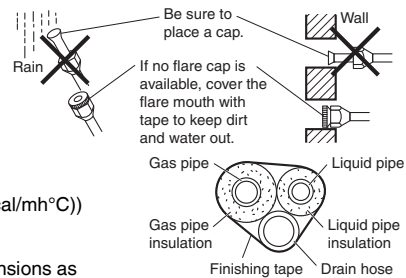

### Selection of copper and heat insulation materials

When using commercial copper pipes and fittings, observe the following:

- Insulation material: Polyethylene foam  
Heat transfer rate: 0.041 to 0.052W/mK (0.024 to 0.030Btu/ft<sup>2</sup>h°F (0.035 to 0.045kcal/mh°C))  
Be sure to use insulation that is designed for use with HVAC Systems.
- ACR Copper only.
- Be sure to insulate both the gas and liquid piping and observe the insulation dimensions as below.

	Piping size	Minimum bend radius	Piping thickness	Thermal insulation size	Thermal insulation thickness
Gas side	O.D. 1/2 inch (12.7mm)	1-15/16 inch (50mm) or more	0.039 inch (1.0mm) (C1220T-O)	I.D. 9/16-5/8 inch (14-16mm)	13/32 inch (10mm) Min.
	O.D. 5/8 inch (15.9mm)			I.D. 5/8-13/16 inch (16-20mm)	
Liquid side	O.D. 1/4 inch (6.4mm)	1-3/16 inch (30mm) or more	0.031 inch (0.8mm) (C1220T-O)	I.D. 5/16-13/32 inch (8-10mm)	

- Use separate thermal insulation pipes for gas and liquid refrigerant pipes.
- Using finishing tape, bundle and wrap the indoor unit piping and drain hose together so that the drain hose is below the other piping.

# Installation Tips

## 1. Removing and installing the front panel

• **Removal method**

- 1) Place your fingers in the indentations on the main unit (one each on the left and right sides), and open the front panel until it stops.
- 2) While pushing the left side front panel shaft outward, push up the front panel and remove it. (Remove the right side front panel shaft in the same manner.)
- 3) After removing both front panel shafts, pull the front panel toward yourself and remove it.

• **Installation method**

Align the tabs of the front panel with the grooves, and push all the way in. Then close slowly. Push the center of the lower surface of the panel firmly to engage the tabs.

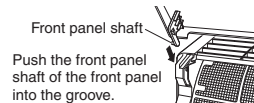
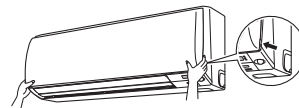

## 2. Removing and installing the front grille

• **Removal method**

- 1) Remove the front panel and air filters.
- 2) Remove screw covers (3 pcs.). (See Fig.1)
- 3) Remove the front grille fixing screws (6 screws). (See Fig.1)
- 4) Remove the service lid screw (1 screw) and remove service lid. (See Fig.2)
- 5) In front of the ○○○ mark on the front grille, there are 3 upper hooks. Lightly pull the front grille toward you with one hand, and push down on the hooks with the fingers of your other hand. (See Fig.3)

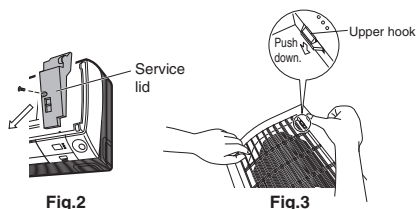
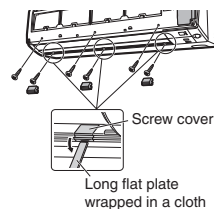

**When there is insufficient work space because the unit is close to ceiling**

Place both hands under the center of the front grille, and while pushing up, pull it toward you.

• **Installation method**

- 1) Install the front grille and firmly engage the upper hooks (3 locations).
- 2) Install the 6 screws of the front grille and screw covers (3 pcs.).
- 3) Install the service lid and screw for fixing the service lid (1 screw).
- 4) Install the air filters and then mount the front panel.

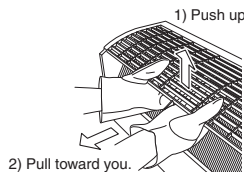

**CAUTION**

- Be sure to wear protection gloves.

# Installation Tips

## 3. How to set the different addresses

When 2 indoor units are installed in one room, the 2 wireless remote controllers can be set for different addresses. Change the address setting of one of the 2 units. When cutting the jumper, be careful not to damage any of the surrounding parts.

- 1) Remove the front grille. (6 screws, 3 screw covers)  
(Refer to “2. Removing and installing the front grille” on page 10.)
- 2) Remove the metal plate electrical wiring box cover. (4 tabs)  
(See Fig.1)
- 3) Cut the address jumper (JA) on the printed circuit board.  
(See Fig.2)
- 4) Cut the address jumper (J4) in the remote controller. (See Fig.3)
  - Do not cut jumper (J8).
- 5) Replace the metal electrical wiring box cover.
- 6) Replace the front grille.

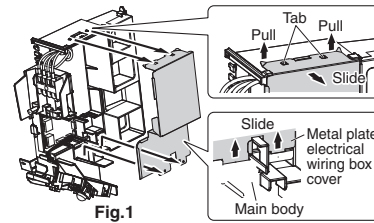

Fig.1

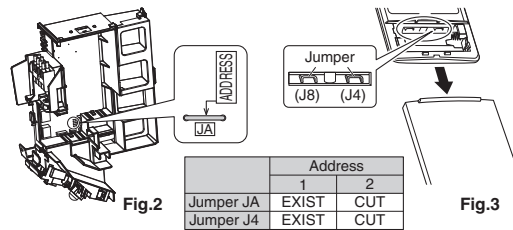

Fig.2

Fig.3

## 4. When connecting to an HA system

**For this procedure, accessories which are sold separately are needed. (wired remote controller, central remote controller, etc.)**

- 1) Remove the front grille. (6 screws, 3 screw covers)  
(Refer to “2. Removing and installing the front grille” on page 10.)
- 2) Remove the metal plate electrical wiring box cover. (4 tabs) (See Fig.1)
- 3) Attach the connection cord to the S21 connector and pull the harness out through the notched part in the figure. (See Fig.4)
- 4) Replace the electrical wiring box cover as it was, and pull the harness around, as shown in the figure. (See Fig.5)
- 5) Replace the front grille.

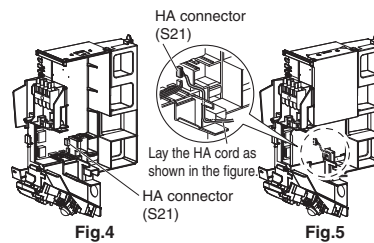







Fig.4

Fig.5

# Trial Operation and Testing

## 1. Trial operation and testing

- Trial operation should be carried out in either COOL or HEAT operation.
- 1-1. Measure the supply voltage and make sure that it is within the specified range.**
- 1-2. In COOL operation, select the lowest programmable temperature; in HEAT operation, select the highest programmable temperature.**
- 1-3. Carry out the trial operation following the instructions in the operation manual to ensure that all functions and parts, such as the movement of the flaps, are working properly.**
  - To protect the air conditioner, restart operation is disabled for 3 minutes after the system has been turned off.
- 1-4. After trial operation is complete, set the temperature to a normal level (78°F to 82°F (26°C to 28°C) in COOL operation, 68°F to 75°F (20°C to 24°C) in HEAT operation).**
- When operating the air conditioner in COOL operation in winter, or HEAT operation in summer, set it to the trial operation mode using the following method.

- 1) Press , , and  at the same time.
- 2) Press , select "7", and press  for confirmation.
- 3) Press  to turn on the system.



- Trial operation will stop automatically after about 30 minutes. To stop the operation, press .
- Some of the functions cannot be used in the trial operation mode.
- The air conditioner draws a small amount of power in its standby mode. If the system is not to be used for some time after installation, shut off the circuit breaker to eliminate unnecessary power consumption.
- If the circuit breaker trips to shut off the power to the air conditioner, the system will restore the original operation mode when the circuit breaker is turned on again.

## 2. Test items

Test items	Symptom	Check
Indoor and outdoor units are installed securely.	Fall, vibration, noise	
No refrigerant gas leaks.	Incomplete cooling/heating function	
Refrigerant gas and liquid pipes and indoor drain hose extension are thermally insulated.	Water leakage	
Draining line is properly installed.	Water leakage	
System is properly grounded.	Electrical leakage	
Only specified wires are used for all wiring, and all wires are connected correctly.	No operation or burn damage	
Indoor or outdoor unit's air inlet or air outlet are unobstructed.	Incomplete cooling/heating function	
Stop valves are opened.	Incomplete cooling/heating function	
Indoor unit properly receives remote control commands.	No operation	

## 12.3 FVXS

# Contents

<b>Safety Considerations .....</b>	<b>1</b>	5. Flaring the pipe end.....	12
<b>Accessories .....</b>	<b>3</b>	6. Refrigerant piping .....	12
<b>Choosing an Installation Site .....</b>	<b>3</b>	6-1. Caution on piping handling.....	13
1. Indoor unit .....	3	6-2. Selection of copper and heat insulation materials.....	13
2. Wireless remote controller.....	3	7. Checking for gas leakage .....	13
<b>Indoor Unit Installation Diagram .....</b>	<b>4</b>	8. Attaching the connection pipe .....	13
<b>Indoor Unit Installation .....</b>	<b>5</b>	9. Wiring .....	14
1. Refrigerant piping .....	5	10. When connecting to an HA system.....	16
2. Drilling a wall hole and installing wall embedded pipe.....	7	11. How to set the different addresses.....	17
3. Drain piping .....	7	<b>Trial Operation and Testing .....</b>	<b>18</b>
4. Installing indoor unit .....	8	1. Trial operation and testing .....	18
4-1. Preparation .....	8	2. Test items .....	18
4-2. Installation .....	9		

The pictures in this document are for illustrative purposes only.

# Safety Considerations





Refer also to the General Safety Considerations in the separate booklet.



**Read the precautions in this manual carefully before operating the unit.**

Read these **Safety Considerations for Installation** carefully before installing an air conditioner or heat pump. After completing the installation, make sure that the unit operates properly during the startup operation. Instruct the user on how to operate and maintain the unit. Inform users that they should store this installation manual with the operation manual for future reference. Always use a licensed installer or contractor to install this product. Improper installation can result in water or refrigerant leakage, electric shock, fire, or explosion.

Meanings of **DANGER**, **WARNING**, **CAUTION**, and **NOTE** Symbols:

-  **DANGER** ..... Indicates an imminently hazardous situation which, if not avoided, will result in death or serious injury.
-  **WARNING** ..... Indicates a potentially hazardous situation which, if not avoided, could result in death or serious injury.
-  **CAUTION** ..... Indicates a potentially hazardous situation which, if not avoided, may result in minor or moderate injury. It may also be used to alert against unsafe practices.
-  **NOTE** ..... Indicates situations that may result in equipment or property damage accidents only.

### **DANGER**

- Refrigerant gas is heavier than air and replaces oxygen. A massive leak can lead to oxygen depletion, especially in basements, and an asphyxiation hazard could occur leading to serious injury or death.
- Do not ground units to water pipes, gas pipes, telephone wires, or lightning rods as incomplete grounding can cause a severe shock hazard resulting in severe injury or death. Additionally, grounding to gas pipes could cause a gas leak and potential explosion causing severe injury or death.

- If refrigerant gas leaks during installation, ventilate the area immediately. Refrigerant gas may produce toxic gas if it comes into contact with fire. Exposure to this gas could cause severe injury or death.
- After completing the installation work, check that the refrigerant gas does not leak throughout the system.
- Do not install unit in an area where flammable materials are present due to risk of explosions that can cause serious injury or death.
- Safely dispose all packing and transportation materials in accordance with federal/state/local laws or ordinances. Packing materials such as nails and other metal or wood parts, including plastic packing materials used for transportation may cause injuries or death by suffocation.

### **WARNING**

- Only qualified personnel licensed or certified in their jurisdiction must carry out the installation work. Installation must be done in accordance with this installation manual. Improper installation may result in water leakage, electric shock, or fire.
- When installing the unit in a small room, take measures to keep the refrigerant concentration from exceeding allowable safety limits. Excessive refrigerant leaks, in the event of an accident in a closed ambient space, can lead to oxygen deficiency.
- Use only specified accessories and parts for installation work. Failure to use specified parts may result in water leakage, electric shock, fire, or the unit falling.
- Install the air conditioner or heat pump on a foundation strong enough that it can withstand the weight of the unit. A foundation of insufficient strength may result in the unit falling and causing injuries.
- Take into account strong winds, typhoons, or earthquakes when installing. Improper installation may result in the unit falling and causing accidents.
- Make sure that a separate power supply circuit is provided for this unit and that all electrical work is carried out by qualified personnel licensed or certified in their jurisdiction according to local, state, and national regulations. An insufficient power supply capacity or improper electrical construction may lead to electric shock or fire.
- Make sure that all wiring is secured, that specified wires are used, and that no external forces act on the terminal connections or wires. Improper connections or installation may result in fire.



- When wiring, position the wires so that the electrical wiring box cover can be securely fastened. Improper positioning of the electrical wiring box cover may result in electric shock, fire, or the terminals overheating.
- Before touching electrical parts, turn off the unit.
- The circuit must be protected with safety devices in accordance with local and national codes, i.e. a circuit breaker.
- Securely fasten the outdoor unit terminal cover (panel). If the terminal cover/panel is not installed properly, dust or water may enter the outdoor unit causing fire or electric shock.
- When installing or relocating the system, keep the refrigerant circuit free from substances other than the specified refrigerant (R410A) such as air. Any presence of air or other foreign substance in the refrigerant circuit can cause an abnormal pressure rise or rupture, resulting in equipment damage and even injury.
- Do not change the setting of the protection devices. If the pressure switch, thermal switch, or other protection device is shorted and operated forcibly, or parts other than those specified by Daikin are used, fire or explosion may occur.
- Do not use means to accelerate the defrosting process (if possible) or to clean, other than those recommended by the manufacturer.
- The appliance must be stored in a room without continuously operating ignition sources (for example: open flames, an operating gas appliance or an operating electric heater).
- Do not pierce or burn.
- Be aware that refrigerants may not contain an odor.
- Comply with national gas regulations.

**⚠ CAUTION**

- Do not touch the switch with wet fingers. Touching a switch with wet fingers can cause electric shock.
- Do not allow children to play on or around the unit to prevent injury.
- Wear adequate personal protective equipment (protective gloves, safety glasses,...) when installing, maintaining or servicing the system.
- The heat exchanger fins are sharp enough to cut. To avoid injury, wear gloves or cover the fins while working around them.
- Do not touch the refrigerant pipes during and immediately after operation as the refrigerant pipes may be hot or cold, depending on the condition of the refrigerant flowing through the refrigerant piping, compressor, and other refrigerant cycle parts. Your hands may suffer burns or frostbite if you touch the refrigerant pipes. To avoid injury, give the pipes time to return to normal temperature or, if you must touch them, be sure to wear proper gloves.
- Install drain piping to ensure proper drainage. Improper drain piping may result in water leakage and property damage.
- Insulate piping to prevent condensation.
- Be careful when transporting the product.
- Do not turn off the power immediately after stopping operation. Always wait for at least 5 minutes before turning off the power. Otherwise, water leakage may occur.
- Do not use a charging cylinder. Using a charging cylinder may cause the refrigerant to deteriorate.
- Refrigerant R410A in the system must be kept clean, dry, and tight.

(a) Clean and Dry -- Foreign materials (including mineral oils such as SUNISO oil or moisture) should be prevented from getting into the system.







- (b) Tight -- R410A does not contain any chlorine, does not destroy the ozone layer, and does not reduce the earth's protection against harmful ultraviolet radiation. R410A can contribute to the greenhouse effect if it is released. Therefore take proper measures to check for the tightness of the refrigerant piping installation. Read the chapter *Refrigerant Piping Work* and follow the procedures.
- Since R410A is a blend, the required additional refrigerant must be charged in its liquid state. If the refrigerant is charged in a state of gas, its composition can change and the system will not work properly.
- The indoor unit is for R410A. See the catalog for outdoor models that can be connected. Normal operation is not possible when connected to non-compatible outdoor units.
- Remote controller (wireless kit) transmitting distance can be shorter than expected in rooms with electronic fluorescent lamps (inverter or rapid start types). Install the indoor unit far away from fluorescent lamps as much as possible.
- Indoor units are for indoor installation only. Outdoor units can be installed either outdoors or indoors.
- Do not install the air conditioner or heat pump in the following locations:
  - (a) Where a mineral oil mist or oil spray or vapor is produced, for example, in a kitchen. Plastic parts may deteriorate and fall off or result in water leakage.
  - (b) Where corrosive gas, such as sulfurous acid gas, is produced. Corroding copper pipes or soldered parts may result in refrigerant leakage.
  - (c) Near machinery emitting electromagnetic waves. Electromagnetic waves may disturb the operation of the control system and cause the unit to malfunction.
  - (d) Where flammable gas may leak, where there is carbon fiber, or ignitable dust suspension in the air, or where volatile flammables such as thinner or gasoline are handled. Operating the unit in such conditions can cause a fire.
- Take adequate measures to prevent the outdoor unit from being used as a shelter by small animals. Small animals making contact with electrical parts can cause malfunctions, smoke, or fire. Instruct the user to keep the area around the unit clean.
- Servicing shall be performed only as recommended by the manufacturer and licensed or certified in their jurisdiction.

**⚠ NOTE**

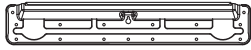
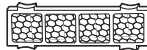
- The indoor unit should be positioned where the unit and inter-unit wires (outdoor to indoor) are at least 3.3ft (1m) away from any televisions or radios. (The unit may cause interference with the picture or sound.) Depending on the radio waves, a distance of 3.3ft (1m) may not be sufficient to eliminate the noise.
- Dismantling the unit, treatment of the refrigerant, oil and additional parts must be done in accordance with the relevant local, state, and national regulations.
- Only use tools for R410A, such as a gauge manifold, charge hose, gas leak detector, reverse flow check valve, refrigerant charge base, vacuum gauge, or refrigerant recovery equipment.
- If the conventional refrigerant and refrigerator oil are mixed in R410A, the refrigerant may deteriorate.
- This air conditioner or heat pump is an appliance that should not be accessible to the general public.
- As maximum allowable pressure is 604psi (4.17MPa), the wall thickness of field-installed pipes should be selected in accordance with the relevant local, state, and national regulations.

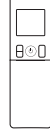
FTN005-U

# Accessories

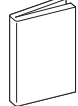
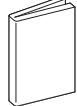
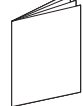
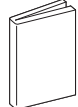
<p>(A) Mounting plate</p>  <p>1</p>	<p>(B) Titanium apatite deodorizing filter</p>  <p>2</p>	<p>(C) Drain hose</p>  <p>1</p>
<p>(D) Insulation tape</p>  <p>2</p>	<p>(E) Wireless remote controller</p>  <p>1</p>	<p>(F) Remote controller holder</p>  <p>1</p>
<p>(G) Remote controller holder fixing screw M3 × 13/16" (M3 × 20mm)</p>  <p>2</p>	<p>(H) Indoor unit fixing screw M4 × 1" (M4 × 25mm)</p>  <p>9</p>	<p>(J) Dry battery AAA. LR03 (alkaline)</p>  <p>2</p>
<p>(K) Operation manual</p>  <p>1</p>	<p>(L) Installation manual</p>  <p>1</p>	<p>(M) Warranty</p>  <p>1</p>
<p>(N) General safety considerations</p>  <p>1</p>		

## Choosing an Installation Site

- Before choosing the installation site, obtain user approval.

### 1. Indoor unit

The indoor unit should be positioned in a place where:

- 1) the restrictions on the installation requirements specified in "Indoor Unit Installation Diagram" on page 4 are met,
- 2) both the air inlet and air outlet are unobstructed,
- 3) the unit is not exposed to direct sunlight,
- 4) Install so that drainage occurs easily,
- 5) the unit is away from sources of heat or steam,
- 6) there is no source of machine oil vapor (this may shorten the indoor unit service life),
- 7) cool/warm air is circulated throughout the room,
- 8) the unit is away from electronic ignition type fluorescent lamps (inverter or rapid start type) as they may affect the remote controller range,
- 9) no laundry equipment is nearby.

### 2. Wireless remote controller

Turn on all the fluorescent lamps in the room, if any, and find a location where the remote controller signals are properly received by the indoor unit (within 23ft (7m)).

# Indoor Unit Installation Diagram

- The indoor unit may be mounted in any of the 3 styles shown here.

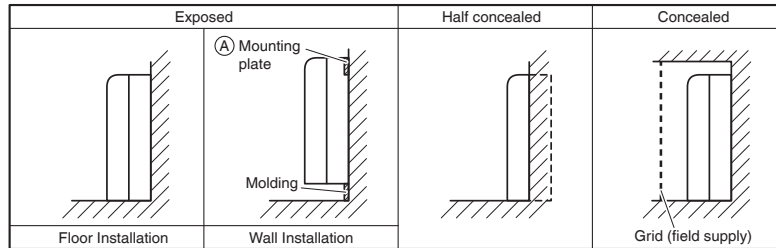

- Recommended mounting plate retention spots and dimensions.

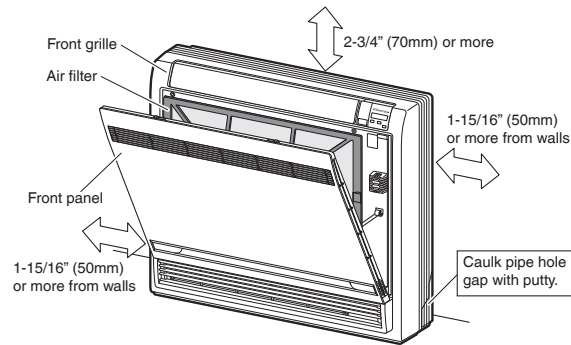
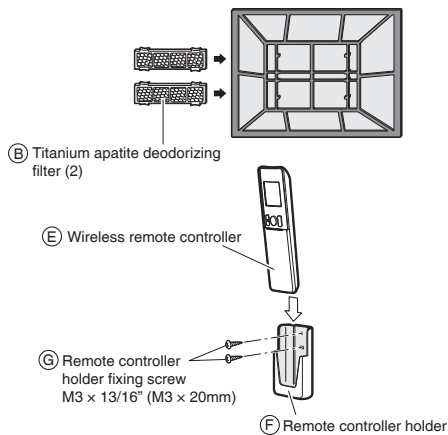
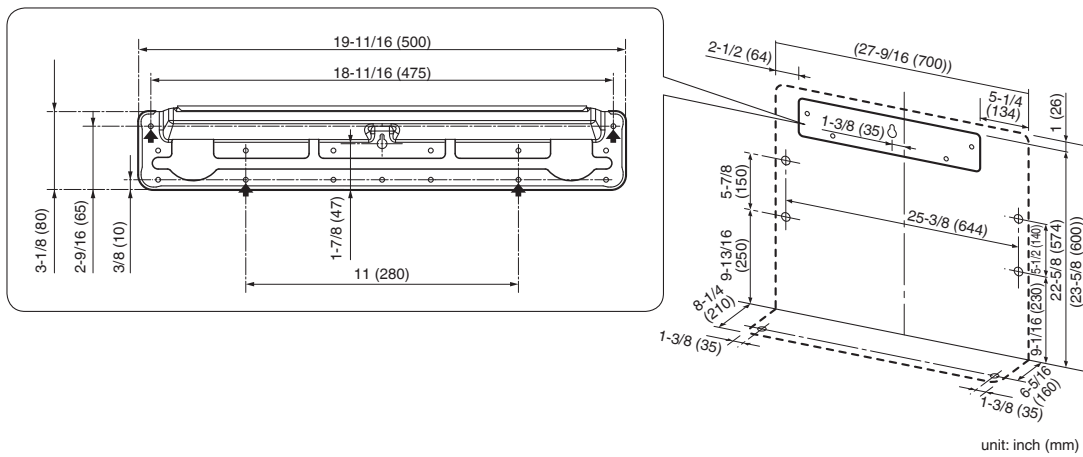

# Indoor Unit Installation

## 1. Refrigerant piping

- 1) Drill a hole ( $\phi 2-9/16$  inch (65mm) in diameter) in the spot indicated by the  $\odot$  symbol in the illustration as below.
- 2) The location of the hole is different depending on which side of the pipe is taken out.
- 3) For piping, refer to "6. Refrigerant piping" on page12.
- 4) Allow space around the pipe for a easier indoor unit pipe connection.

### [Bottom piping]

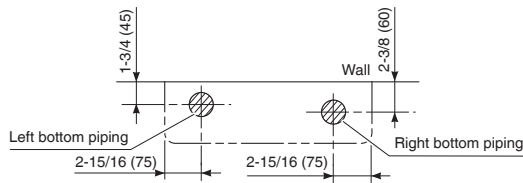

Exposed installation

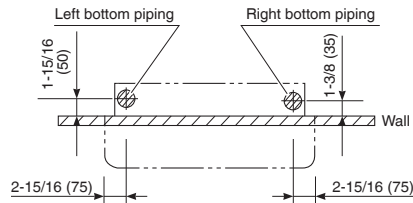

Half concealed installation

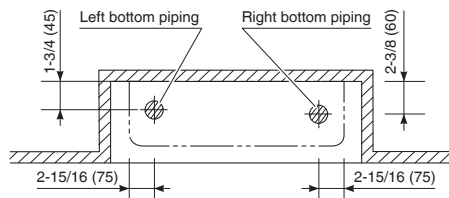

Concealed installation

unit: inch (mm)

### [Left/Right -side piping]

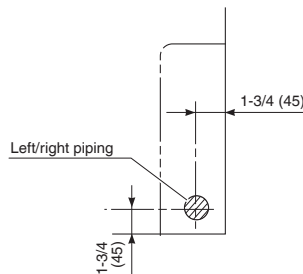

Exposed installation

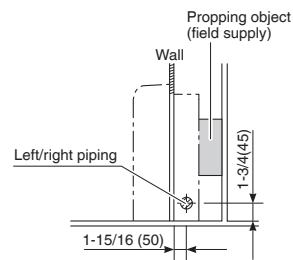

Half concealed installation

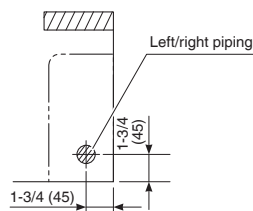

Concealed installation

unit: inch (mm)

**[Back piping]**

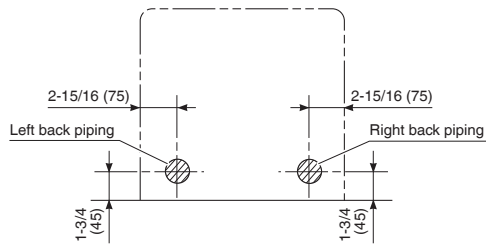

unit: inch (mm)

**About the outdoor unit refrigerant pipe**

- In order to connect the pipe, the outdoor unit refrigerant pipe must have a length of at least 13-3/4 inch (350mm) measured from the wall.

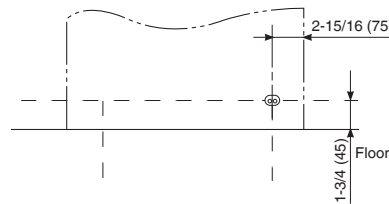
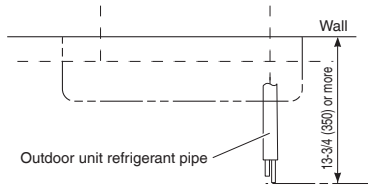

unit: inch (mm)

**⚠ CAUTION**

**Minimum allowable length**

- The suggested shortest pipe length is 8.2ft (2.5m), in order to avoid noise from the outdoor unit and vibration. (Mechanical noise and vibration may occur depending on how the unit is installed and the environment in which it is used.)
- Refer to the installation manual for the outdoor unit for the maximum pipe length.
- For multi-connections, refer to the installation manual for the multi outdoor unit.

# Indoor Unit Installation

## 2. Drilling a wall hole and installing wall embedded pipe

### ⚠ WARNING

For metal frame or metal board walls, be sure to use a wall embedded pipe and wall hole cover in the feed-through hole to prevent possible heat, electric shock, or fire.

- Be sure to caulk the gaps around the pipes with caulking material. (to prevent condensation caused by intrusion of air from outside or within the wall)
- 1) Drill a feed-through hole with a  $\phi 2\text{-}9/16$  inch (65mm) diameter through the wall at a downward angle toward the outside. (to prevent water leakage)
  - 2) Insert a wall embedded pipe into the hole.
  - 3) Insert a wall hole cover into wall pipe.
  - 4) After completing refrigerant piping, wiring, and drain piping, caulk the pipe hole gap with putty.

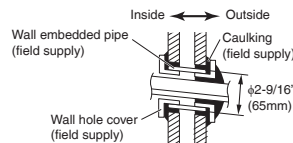

Even if a wall hole cover is not used, caulk both the outdoor and indoor sides with putty.

## 3. Drain piping

- 1) Perform drain piping work as outlined in the figure. (See Fig. 1)
  - Insert the © drain hose into the socket of the drain pan. (See Fig. 2) Fully insert the drain hose until it adheres to a seal of the socket.
  - The drain hose (outer diameter  $\phi 1\text{-}1/16$  inch ( $\phi 18\text{mm}$ ) at connecting end, 8-11/16 inch (220mm) long) is supplied with the indoor unit.
  - Use commercial rigid polyvinyl chloride pipe (general VP 20 pipe, outer diameter 1 inch (26mm), inner diameter 13/16 inch (20mm)) for the drain pipe.

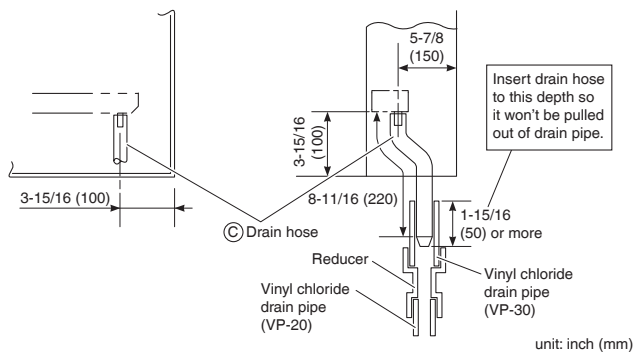

Fig. 1

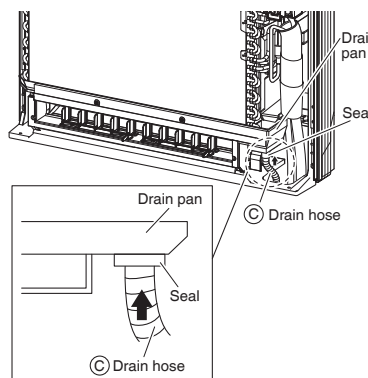
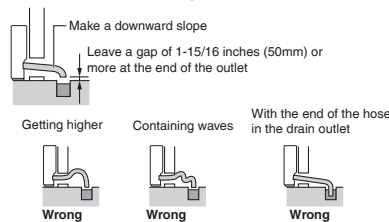

Fig. 2

- The drain pipe should be **inclined downward** so that water will flow smoothly without any accumulation. (Should not be trap.)
- Avoid placing the end of the drain hose in a drainage location that could cause bad odours or corrosive gas to flow backward into the outlet.
- The drainage water may change colour due to bacteria or other organisms. Place in a location where the flow of drainage water will not cause a problem.
- Minimize the number of bends in the drain hose as much as possible. If bending the drain hose, bend it gently.



- 2) Insulate the indoor drain pipe with 3/8 inch (10mm) or more of insulation material to prevent condensation.
- 3) Remove the air filters and pour some water into the drain pan to check the water flows smoothly.

### ⚠ CAUTION

Use polyvinyl chloride adhesive agent for gluing. Failure to do so may cause water leakage.

## 4. Installing indoor unit

### 4-1. Preparation

- Remove the front panel.
  - 1) Slide until the 2 stoppers click inside.
  - 2) Open the front panel forward and remove the string.
  - 3) Remove the front panel.

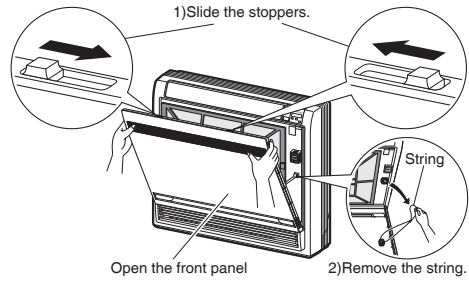

- Remove the front grille.
  - 1) Remove the 4 screws.
  - 2) Pull the front grille and remove the 3 tabs.

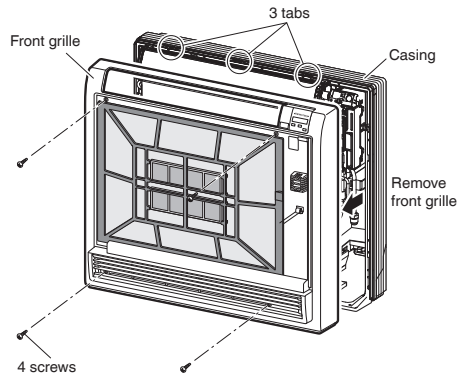

- Remove the upper and the side casings.
  - 1) Remove the 7 screws.
  - 2) Slide and remove the upper casing (2 tabs).
  - 3) Slide and remove the left and right casings (2 tabs on each side).

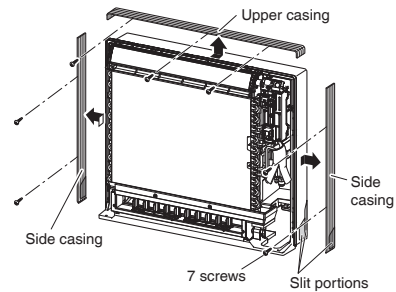

- During installation, if needed, cut the slit portions using nippers as shown in the illustration below.

#### [For moldings]

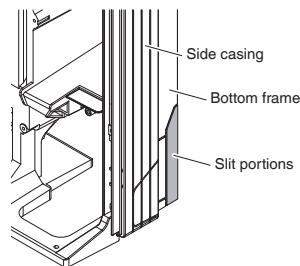

#### [For side piping]

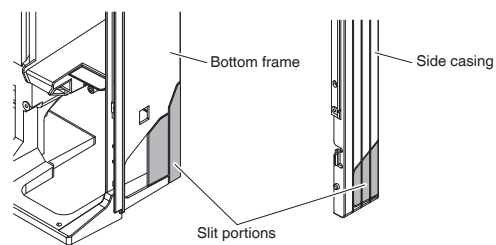

# Indoor Unit Installation

## 4-2. Installation

### Exposed installation

1) Secure the indoor unit

#### [Floor Installation]

- Secure the indoor unit using 6 screws. (2 screws for floor and 4 screws for rear wall)

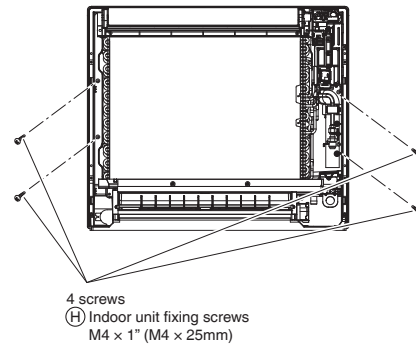
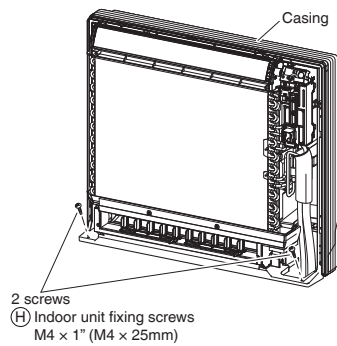

#### [Wall Installation]

- Secure the (A) mounting plate using 5 screws.
- Secure the indoor unit using 4 screws for rear wall.

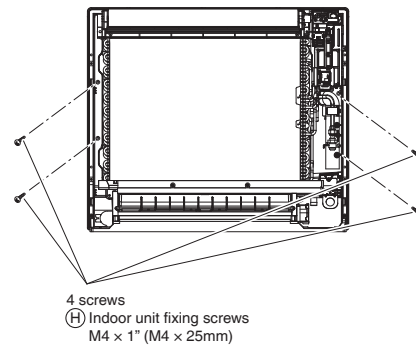
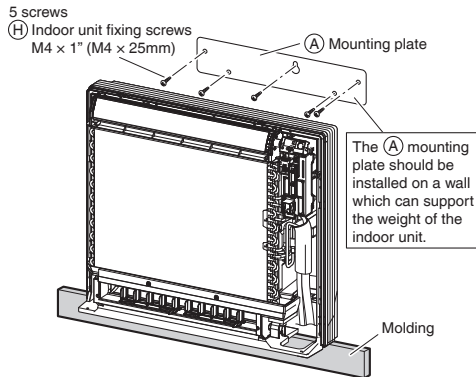

- Once refrigerant piping and drain piping connections are complete, fill in the gap of the through hole with putty. **Any gaps will result in the accumulation of condensation on the refrigerant pipe and drain pipe, as well as allowing the intrusion of insects and dirt.**
- Attach the left, right and upper casings in their original positions using 7 screws.
- Attach the front grill in its original position using 4 screws.
- Attach the front panel in its original position.
  - Attach the string to the right, inner-side of the front grille.
  - Close the front panel and slide until the 2 stoppers click outside.

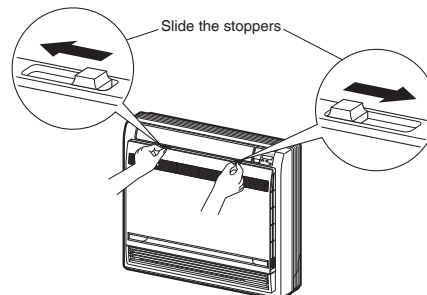



**Half concealed installation**

1) The size of a wall opening space shown in the illustration on the right.

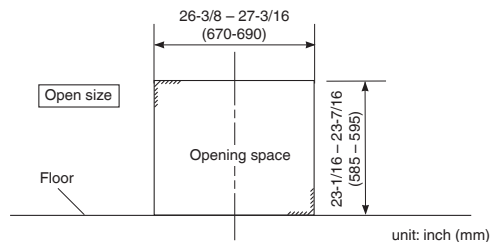

2) The rear of the unit can be fixed with screws at the points shown in the illustration as below. Be sure to install the propping object in accordance with the depth of the inner wall.

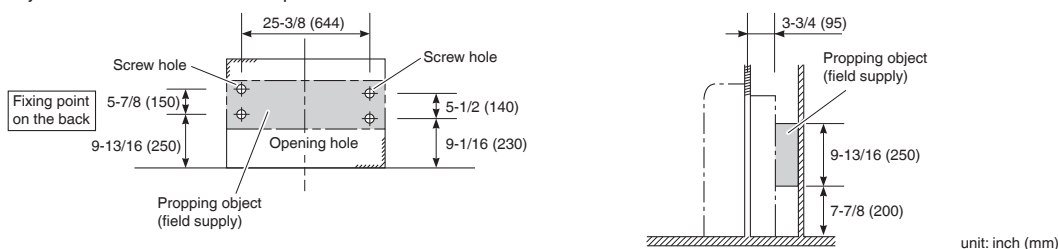

**CAUTION**

The propping object for installing the main unit must be used, or there will be a gap between the unit and the wall.

3) Secure the indoor unit using 6 screws. (2 screws for floor and 4 screws for rear wall)

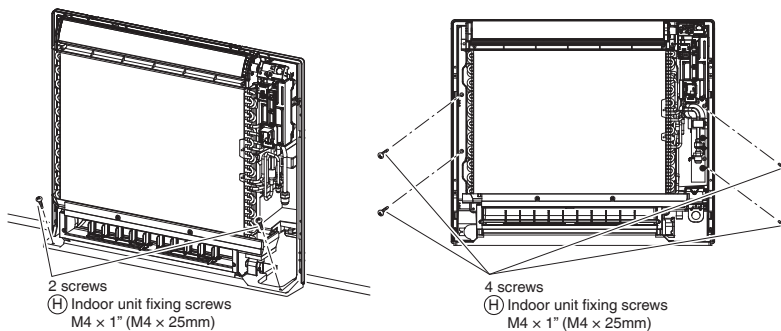

4) Once refrigerant piping and drain piping connections are complete, fill in the gap of the through hole with putty. **Any gaps will result in the accumulation of condensation on the refrigerant pipe and drain pipe, as well as allowing the intrusion of insects and dirt.**

5) Attach the left, right and upper casings in their original positions using 7 screws.

6) Attach the front grill in its original position using 4 screws.

7) Attach the front panel in its original position.

- Attach the string to the right, inner-side of the front grille.
- Close the front panel and slide until the 2 stoppers click outside.

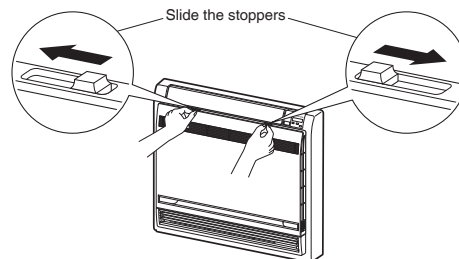

**CAUTION**

- Use drain pan edge for horizontal projection of the indoor unit.
- Install the indoor unit flush against wall.

# Indoor Unit Installation

## Concealed installation

- Install the unit according to the instructions below. Failure to do so may cause lead to both cooling and heating failure and the condensation inside the house.
  - 1) Allow enough space between the main unit and ceiling not to obstruct the flow of cool/warm air.
  - 2) Place a partition plate between outlet and inlet sections.
  - 3) Place a partition plate on the right side.
  - 4) Change the upward airflow dipswitch (SW2-4) to ON to limit the upward airflow. (Factory default: OFF)
    - Remove the front grille.
    - Switch the dipswitch (SW2-4) on the PCB in the electrical equipment box to ON.

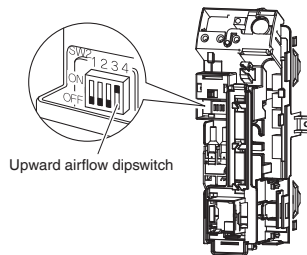

**CAUTION** Be sure to turn on the upward airflow switch. Failure to do so may cause incomplete cooling/heating and formation of condensation inside the house.

- 5) Use a movable lattice at the air outlet to allow the adjustment of cool/warm airflow direction.
- 6) Lattice size should be 70% or more of open rate.

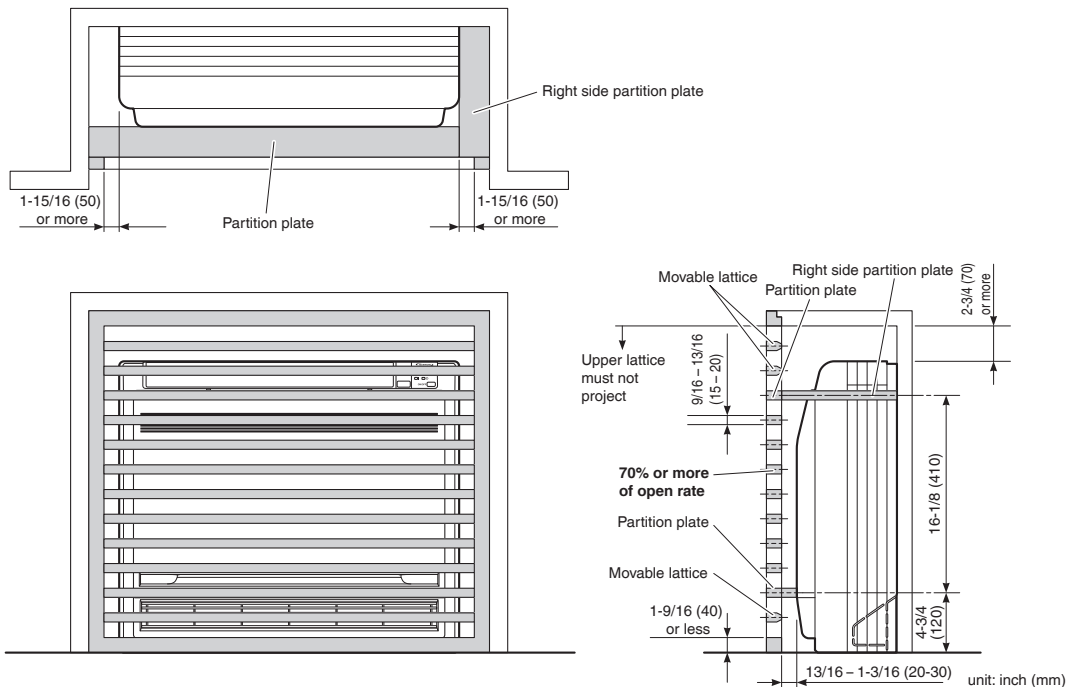

• For the installation process refer to “Exposed installation” on page 9.

**⚠ WARNING**

- Do not apply mineral oil to the flare.
- Prevent mineral oil from getting into the system as this would reduce the service life of the units.
- Never use piping which has been used for previous installations. Only use parts which are delivered with this unit.
- Never install a dryer to this R410A unit in order to guarantee its service life.
- The drying material may dissolve and damage the system.
- Improper flaring may result in refrigerant gas leakage.

**5. Flaring the pipe end**

- 1) Cut the pipe end with a pipe cutter.
- 2) Remove burrs with the cut surface facing downward, so that the filings do not enter the pipe.



- 3) Put the flare nut on the pipe.
- 4) Flare the pipe.
- 5) Check that the flaring has been done correctly.

Set exactly at the position shown below.

Flaring		Flare tool for R410A		Conventional flare tool	
		Clutch-type	Clutch-type (Rigid-type)	Wing-nut type (Imperial-type)	
A	0-0.020 inch (0-0.5mm)	0.039-0.059 inch (1.0-1.5mm)	0.059-0.079 inch (1.5-2.0mm)		

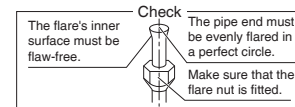

**6. Refrigerant piping**

**⚠ CAUTION**

- Use the flare nut fixed to the main unit. (This is to prevent the flare nut from cracking as a result of deterioration over time.)
- To prevent gas leakage, apply refrigeration oil only to the inner surface of the flare. (Use refrigeration oil for R410A.)
- Use a torque wrench when tightening the flare nuts to prevent damage to the flare nuts and gas leakage.

- Align the centers of both flares and tighten the flare nuts 3 or 4 turns by hand, then tighten them fully with a spanner and a torque wrench.

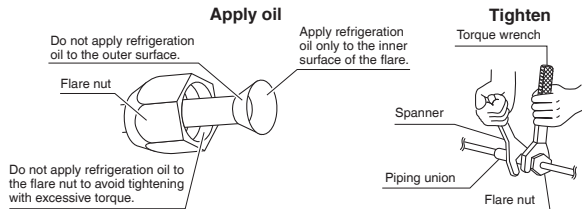

	Piping size	Flare nut tightening torque
Gas side	O.D. 3/8 inch (9.5mm)	24-1/8 – 29-1/2lbf • ft (32.7-39.9N • m)
	O.D. 1/2 inch (12.7mm)	36-1/2 – 44-1/2lbf • ft (49.5-60.3N • m)
Liquid side	O.D. 1/4 inch (6.4mm)	10-1/2 – 12-3/4lbf • ft (14.2-17.2 N • m)

# Indoor Unit Installation

## 6-1. Caution on piping handling

- 1) Protect the open end of the pipe against dust and moisture.
- 2) All pipe bends should be as gentle as possible. Use a pipe bender for bending.

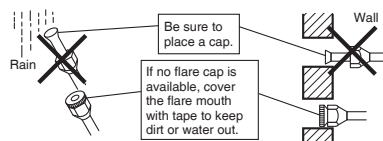

## 6-2. Selection of copper and heat insulation materials

When using commercial copper pipes and fittings, observe the following:

- Insulation material: Polyethylene foam  
Heat transfer rate: 0.041 to 0.052W/mK (0.024 to 0.030Btu/ft<sup>2</sup>h°F (0.035 to 0.045kcal/mh°C))  
Be sure to use insulation that is designed for use with HVAC Systems.
- ACR Copper only.

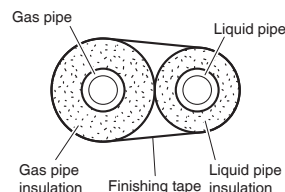

- Be sure to insulate both the gas and liquid piping and observe the insulation dimensions as below.

	Piping size	Minimum bend radius	Piping thickness	Thermal insulation size	Thermal insulation thickness
Gas side	O.D. 3/8 inch (9.5mm)	1-3/16 inch (30mm) or more	0.031 inch (0.8mm) (C1220T-O)	I.D. 15/32-19/32 inch (12-15mm)	13/32 inch (10mm) Min.
	O.D. 1/2 inch (12.7mm)	1-9/16 inch (40mm) or more		I.D. 9/16-5/8 inch (14-16mm)	
Liquid side	O.D. 1/4 inch (6.4mm)	1-3/16 inch (30mm) or more		I.D. 5/16-13/32 inch (8-10mm)	

- Use separate thermal insulation pipes for gas and liquid refrigerant pipes.

## 7. Checking for gas leakage

- 1) Check for leakage of gas after air purging.
- 2) Refer to the section on pressure test and evacuating system in the installation manual for the outdoor unit.

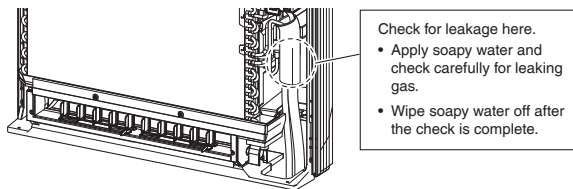

## 8. Attaching the connection pipe

- Attach the pipe after checking for gas leakage, described above.
- 1) Cut the insulated portion of the on-site piping, matching it up with the connecting portion.
  - 2) Secure the slit on the refrigerant piping side with the butt joint on the auxiliary piping using the tape, making sure there are no gaps.
  - 3) Wrap the slit and the butt joint with the (D) insulation tape, making sure there are no gaps.

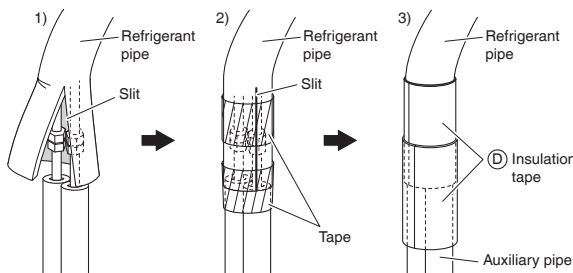

### ⚠ CAUTION

- Insulate the joint of the pipes securely. Incomplete insulation may lead to water leakage.
- Push the pipe inside so it does not place undue force on the front grille.

## 9. Wiring

Refer to the installation manual for the outdoor unit also.

### **⚠ WARNING**

- Do not use tapped wires, extension cords, or starburst connections, as they may cause overheating, electric shock, or fire.
- Do not use locally purchased electrical parts inside the product. (Do not branch the power for the drain pump, etc., from the terminal block.) Doing so may cause electric shock or fire.
- Do not connect the power wire to the indoor unit. Doing so may cause electric shock or fire.

### **⚠ CAUTION**

Recommend stranded cable for interunit wiring. Local code always supersedes recommendation.

- For stranded wires, make sure to use the round crimp-style terminal for connection to the power supply terminal block. Place the round crimp-style terminals on the wires up to the covered part and secure in place.

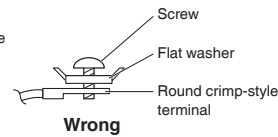
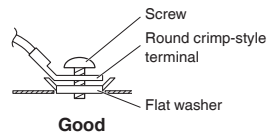
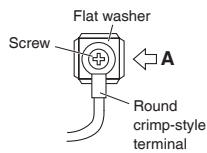
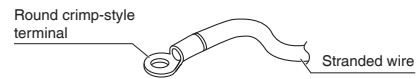

Arrow view A

- If solid core wire must be used, be sure to curl the end of the lead. Improper work may cause heat and fire.

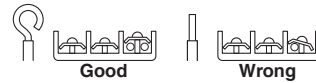

# Indoor Unit Installation

**With a multi indoor unit** , install as described in the installation manual supplied with the multi outdoor unit.

- Live the sensor securing plate, remove the front electrical wiring box cover, and connect the branch wiring to the terminal block.
  - 1) As shown in the illustration, insert the wires including the ground wire into the conduit and secure them with lock nut onto the conduit mounting plate.
  - 2) Strip wire ends (3/4 inch (20mm)).
  - 3) Match wire colours with terminal numbers on indoor and outdoor unit's terminal blocks and firmly secure the wires in the corresponding terminals with the screws.
  - 4) Connect the ground wires to the corresponding terminals.
  - 5) Pull the wires lightly to make sure they are securely connected.
  - 6) Make sure that the wires do not come in contact with the metal conduit for the heat exchanger.
  - 7) In case of connecting to an adapter system, run the remote controller cable and attach the S21. (Refer to "10. When connecting to an HA system" on page 16.)

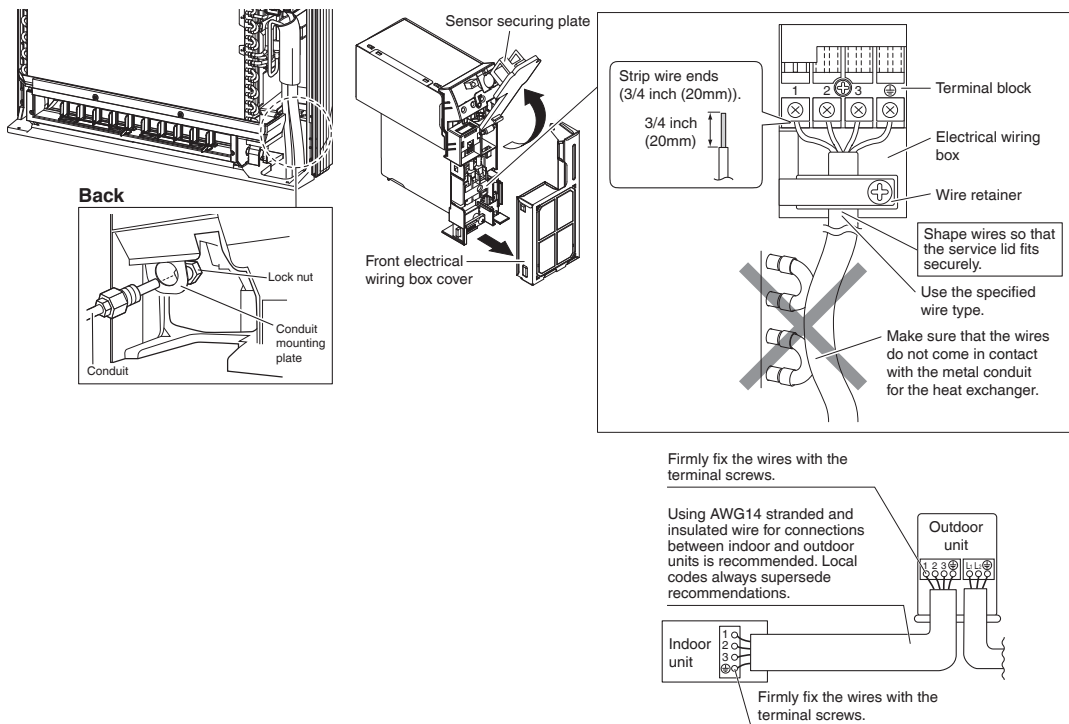

## 10. When connecting to an HA system

- 1) Remove the front panel and the front grille. (Refer to “4-1. Preparation” on page 8.)
- 2) Open up the sensor securing plate. (See Fig. 3)
- 3) Remove the front electrical wiring box cover (4 tabs). (See Fig. 3)
- 4) Remove connectors ① ② ③. (See Fig. 4 and Fig. 5)
- 5) After removing the ground wires (2 screws), remove the electrical wiring box (1 screw). (See Fig. 6)
- 6) Remove the thermistor. (See Fig. 7)
- 7) Remove the side electrical wiring box cover (7 tabs). (See Fig. 3)
- 8) Cut off the pins using a nipper. (See Fig. 3)
- 9) Wire and connect the HA connection cord to the S21 connector. (See Fig. 3)
- 10) Install the side electrical wiring box cover while being careful not to pinch the HA connection cord or ground wires (7 tabs).
- 11) Attach the thermistor.
- 12) Install the ground wires (2 screws) and the electrical wiring box (1 screw).
- 13) Install the connectors ① ② and guide the cord as shown in the figure. (See Fig. 4)
- 14) Install connector ③ and guide the cord as shown in the figure. (See Fig. 5)
- 15) Attach the front electrical wiring box cover (4 tabs), and close the sensor securing plate.
- 16) Attach the front panel and the front grille as they were.

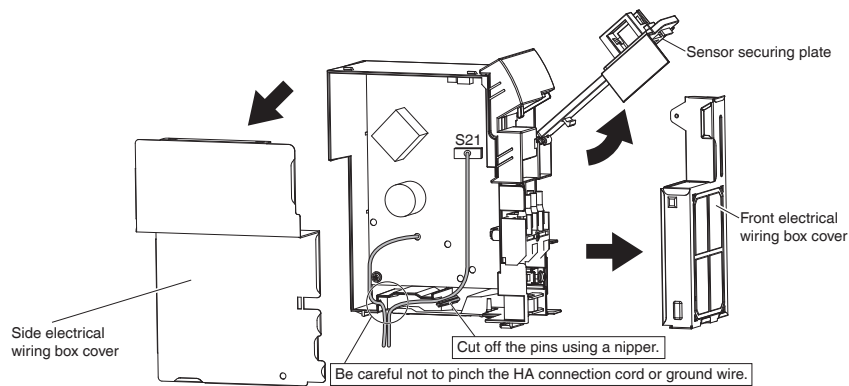

Fig. 3

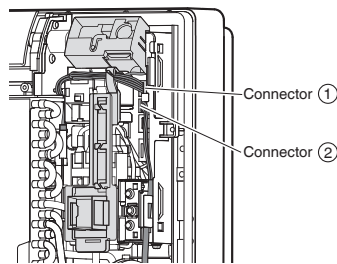

Fig. 4

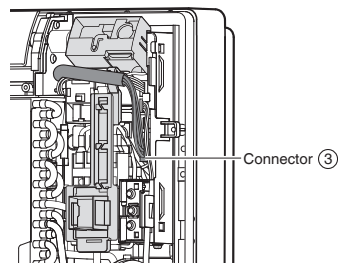

Fig. 5

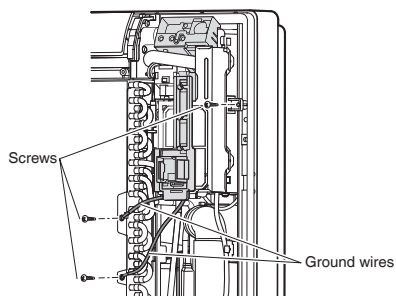

Fig. 6

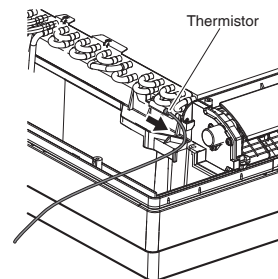

Fig. 7



# Indoor Unit Installation

## 11. How to set the different addresses

- When 2 indoor units are installed in 1 room, the 2 wireless remote controllers can be set for different addresses. Change the address setting of one of the 2 units. When cutting the jumper be careful not to damage any of the surrounding parts.
- 1) Remove the electrical wiring box. (Refer to "10. When connecting to an HA system" on page 16 steps 1)-7).)
  - 2) Cut the address jumper (JA) on the printed circuit board.
  - 3) Cut the address jumper (J4) in the remote controller.
  - 4) Attach the electrical wiring box as they were. (Refer to "10. When connecting to an HA system" on page 16 steps 10)-15).)
  - 5) Attach the front panel and the front grille as they were.

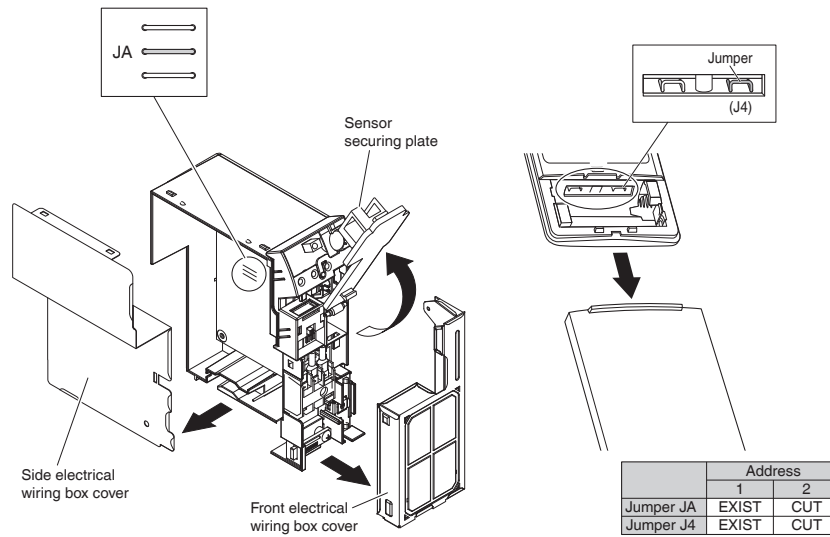







# Trial Operation and Testing

## 1. Trial operation and testing

- Trial operation should be carried out in either COOL or HEAT operation.
- 1-1. Measure the supply voltage and make sure that it is within the specified range.**
- 1-2. In COOL operation, select the lowest programmable temperature; in HEAT operation, select the highest programmable temperature.**
- 1-3. Carry out the trial operation following the instructions in the operation manual to ensure that all functions and parts, such as the movement of the flap, are working properly.**
  - To protect the air conditioner, restart operation is disabled for 3 minutes after the system has been turned off.
- 1-4. After trial operation is complete, set the temperature to a normal level (78°F to 82°F (26°C to 28°C) in COOL operation, 68°F to 75°F (20°C to 24°C) in HEAT operation).**

• When operating the air conditioner in COOL operation in winter, or HEAT operation in summer, set it to the trial operation mode using the following method.

- 1) Press , , and  at the same time.
- 2) Press , select “7””, and press  for confirmation.
- 3) Press  to turn on the system.



• Trial operation will stop automatically after about 30 minutes.

To stop the operation, press .

• Some of the functions cannot be used in the trial operation mode.

- The air conditioner draws a small amount of power in its standby mode. If the system is not to be used for some time after installation, shut off the circuit breaker to eliminate unnecessary power consumption.
- If the circuit breaker trips to shut off the power to the air conditioner, the system will restore the original operation mode when the circuit breaker is opened again.

## 2. Test items

Test Items	Symptom	Check
Indoor and outdoor units are installed securely.	Fall, vibration, noise	
No refrigerant gas leaks.	Incomplete cooling/heating function	
Refrigerant gas and liquid pipes and indoor drain hose extension are thermally insulated.	Water leakage	
Draining line is properly installed.	Water leakage	
System is properly grounded.	Electrical leakage	
Only specified wires are used for all wiring, and all wires are connected correctly.	No operation or burn damage	
Indoor or outdoor unit's air inlet or air outlet are unobstructed.	Incomplete cooling/heating function	
Stop valves are opened.	Incomplete cooling/heating function	
Indoor unit properly receives remote control commands.	No operation	
 will be displayed when the MODE button is pressed.	No heating	

12.4 FDMQ

# Contents

<b>Safety Considerations</b> .....	<b>1</b>	8. Drain piping work.....	8
<b>Before Installation</b> .....	<b>3</b>	9. Wiring .....	11
<b>Accessories</b> .....	<b>3</b>	10. Duct work .....	15
<b>Choosing an Installation Site</b> .....	<b>4</b>	<b>Refrigerant Piping Work</b> .....	<b>16</b>
<b>Indoor Unit Installation</b> .....	<b>5</b>	1. Flaring the pipe end.....	16
1. Check the relation of location between the ceiling opening and the indoor unit suspension bolts. (unit: inch (mm)) .....	5	2. Refrigerant piping .....	16
2. Mount canvas ducts, sound absorbing material and anti-vibration rubber.....	6	<b>Field Settings</b> .....	<b>18</b>
3. The indoor unit is set to standard external static pressure.....	6	1. Setting remote controller .....	18
4. Open installation holes (in the case of installation onto the existing ceiling).....	6	2. Settings for external static pressure .....	18
5. Installing the suspension bolts .....	6	3. Setting for options.....	19
6. In the case of changing the preset suction to underside suction, replace the chamber cover and the suction flange.....	6	4. Setting air filter sign.....	19
7. Installing the indoor unit .....	7	5. When implementing group control.....	19
		<b>Trial Operation and Testing</b> .....	<b>20</b>
		1. Trial operation and testing .....	20
		2. Test items .....	21
		3. How to diagnose for malfunction .....	23
		4. Malfunction code .....	23

The pictures in this document are for illustrative purposes only.

# Safety Considerations

Refer also to the General Safety Considerations in the separate booklet.







**Read the precautions in this manual carefully before operating the unit.**

Read these **Safety Considerations for Installation** carefully before installing an air conditioner or heat pump. After completing the installation, make sure that the unit operates properly during the startup operation.

Instruct the user on how to operate and maintain the unit. Inform users that they should store this installation manual with the operation manual for future reference.

Always use a licensed installer or contractor to install this product. Improper installation can result in water or refrigerant leakage, electric shock, fire, or explosion.

Meanings of **DANGER**, **WARNING**, **CAUTION**, and **NOTE** Symbols:

-  **DANGER** ..... Indicates an imminently hazardous situation which, if not avoided, will result in death or serious injury.
-  **WARNING** ..... Indicates a potentially hazardous situation which, if not avoided, could result in death or serious injury.
-  **CAUTION** ..... Indicates a potentially hazardous situation which, if not avoided, may result in minor or moderate injury. It may also be used to alert against unsafe practices.
-  **NOTE** ..... Indicates situations that may result in equipment or property damage accidents only.

## **DANGER**

- Refrigerant gas is heavier than air and replaces oxygen. A massive leak can lead to oxygen depletion, especially in basements, and an asphyxiation hazard could occur leading to serious injury or death.
- Do not ground units to water pipes, gas pipes, telephone wires, or lightning rods as incomplete grounding can cause a severe shock hazard resulting in severe injury or death. Additionally, grounding to gas pipes could cause a gas leak and potential explosion causing severe injury or death.

- If refrigerant gas leaks during installation, ventilate the area immediately. Refrigerant gas may produce toxic gas if it comes into contact with fire. Exposure to this gas could cause severe injury or death.
- After completing the installation work, check that the refrigerant gas does not leak throughout the system.
- Do not install unit in an area where flammable materials are present due to risk of explosions that can cause serious injury or death.
- Safely dispose all packing and transportation materials in accordance with federal/state/local laws or ordinances. Packing materials such as nails and other metal or wood parts, including plastic packing materials used for transportation may cause injuries or death by suffocation.

## **WARNING**

- Only qualified personnel licensed or certified in their jurisdiction must carry out the installation work. Installation must be done in accordance with this installation manual. Improper installation may result in water leakage, electric shock, or fire.
- When installing the unit in a small room, take measures to keep the refrigerant concentration from exceeding allowable safety limits. Excessive refrigerant leaks, in the event of an accident in a closed ambient space, can lead to oxygen deficiency.
- Use only specified accessories and parts for installation work. Failure to use specified parts may result in water leakage, electric shock, fire, or the unit falling.
- Install the air conditioner or heat pump on a foundation strong enough that it can withstand the weight of the unit. A foundation of insufficient strength may result in the unit falling and causing injuries.
- Take into account strong winds, typhoons, or earthquakes when installing. Improper installation may result in the unit falling and causing accidents.
- Make sure that a separate power supply circuit is provided for this unit and that all electrical work is carried out by qualified personnel licensed or certified in their jurisdiction according to local, state, and national regulations. An insufficient power supply capacity or improper electrical construction may lead to electric shock or fire.
- Make sure that all wiring is secured, that specified wires are used, and that no external forces act on the terminal connections or wires. Improper connections or installation may result in fire.

- When wiring, position the wires so that the electrical wiring box cover can be securely fastened. Improper positioning of the electrical wiring box cover may result in electric shock, fire, or the terminals overheating.
- Before touching electrical parts, turn off the unit.
- The circuit must be protected with safety devices in accordance with local and national codes, i.e. a circuit breaker.
- Securely fasten the outdoor unit terminal cover (panel). If the terminal cover/panel is not installed properly, dust or water may enter the outdoor unit causing fire or electric shock.
- When installing or relocating the system, keep the refrigerant circuit free from substances other than the specified refrigerant (R410A) such as air. Any presence of air or other foreign substance in the refrigerant circuit can cause an abnormal pressure rise or rupture, resulting in equipment damage and even injury.
- Do not change the setting of the protection devices. If the pressure switch, thermal switch, or other protection device is shorted and operated forcibly, or parts other than those specified by Daikin are used, fire or explosion may occur.
- Do not use means to accelerate the defrosting process (if possible) or to clean, other than those recommended by the manufacturer.
- The appliance must be stored in a room without continuously operating ignition sources (for example: open flames, an operating gas appliance or an operating electric heater).
- Do not pierce or burn.
- Be aware that refrigerants may not contain an odor.
- Comply with national gas regulations.

### CAUTION

- Do not touch the switch with wet fingers. Touching a switch with wet fingers can cause electric shock.
- Do not allow children to play on or around the unit to prevent injury.
- Wear adequate personal protective equipment (protective gloves, safety glasses,...) when installing, maintaining or servicing the system.
- The heat exchanger fins are sharp enough to cut. To avoid injury, wear gloves or cover the fins while working around them.
- Do not touch the refrigerant pipes during and immediately after operation as the refrigerant pipes may be hot or cold, depending on the condition of the refrigerant flowing through the refrigerant piping, compressor, and other refrigerant cycle parts. Your hands may suffer burns or frostbite if you touch the refrigerant pipes. To avoid injury, give the pipes time to return to normal temperature or, if you must touch them, be sure to wear proper gloves.
- Install drain piping to ensure proper drainage. Improper drain piping may result in water leakage and property damage.
- Insulate piping to prevent condensation.
- Be careful when transporting the product.
- Do not turn off the power immediately after stopping operation. Always wait for at least 5 minutes before turning off the power. Otherwise, water leakage may occur.
- Do not use a charging cylinder. Using a charging cylinder may cause the refrigerant to deteriorate.
- Refrigerant R410A in the system must be kept clean, dry, and tight.

- (a) Clean and Dry -- Foreign materials (including mineral oils such as SUNISO oil or moisture) should be prevented from getting into the system.

- (b) Tight -- R410A does not contain any chlorine, does not destroy the ozone layer, and does not reduce the earth's protection against harmful ultraviolet radiation. R410A can contribute to the greenhouse effect if it is released. Therefore take proper measures to check for the tightness of the refrigerant piping installation. Read the chapter *Refrigerant Piping Work* and follow the procedures.
- Since R410A is a blend, the required additional refrigerant must be charged in its liquid state. If the refrigerant is charged in a state of gas, its composition can change and the system will not work properly.
- The indoor unit is for R410A. See the catalog for outdoor models that can be connected. Normal operation is not possible when connected to non-compatible outdoor units.
- Remote controller (wireless kit) transmitting distance can be shorter than expected in rooms with electronic fluorescent lamps (inverter or rapid start types). Install the indoor unit far away from fluorescent lamps as much as possible.
- Indoor units are for indoor installation only. Outdoor units can be installed either outdoors or indoors.
- Do not install the air conditioner or heat pump in the following locations:
  - (a) Where a mineral oil mist or oil spray or vapor is produced, for example, in a kitchen. Plastic parts may deteriorate and fall off or result in water leakage.
  - (b) Where corrosive gas, such as sulfurous acid gas, is produced. Corroding copper pipes or soldered parts may result in refrigerant leakage.
  - (c) Near machinery emitting electromagnetic waves. Electromagnetic waves may disturb the operation of the control system and cause the unit to malfunction.
  - (d) Where flammable gas may leak, where there is carbon fiber, or ignitable dust suspension in the air, or where volatile flammables such as thinner or gasoline are handled. Operating the unit in such conditions can cause a fire.
- Take adequate measures to prevent the outdoor unit from being used as a shelter by small animals. Small animals making contact with electrical parts can cause malfunctions, smoke, or fire. Instruct the user to keep the area around the unit clean.
- Servicing shall be performed only as recommended by the manufacturer and licensed or certified in their jurisdiction.

### NOTE

- The indoor unit should be positioned where the unit and inter-unit wires (outdoor to indoor) are at least 3.3ft (1m) away from any televisions or radios. (The unit may cause interference with the picture or sound.) Depending on the radio waves, a distance of 3.3ft (1m) may not be sufficient to eliminate the noise.
- Dismantling the unit, treatment of the refrigerant, oil and additional parts must be done in accordance with the relevant local, state, and national regulations.
- Only use tools for R410A, such as a gauge manifold, charge hose, gas leak detector, reverse flow check valve, refrigerant charge base, vacuum gauge, or refrigerant recovery equipment.
- If the conventional refrigerant and refrigerator oil are mixed in R410A, the refrigerant may deteriorate.
- This air conditioner or heat pump is an appliance that should not be accessible to the general public.
- As maximum allowable pressure is 604psi (4.17MPa), the wall thickness of field-installed pipes should be selected in accordance with the relevant local, state, and national regulations.

FTN005-U











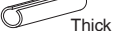

# Before Installation

- Leave the unit inside its packaging until you reach the installation site. Where unpacking is unavoidable, use a sling of soft material or protective plates together with a rope when lifting, this to avoid damage or scratches to the unit. When unpacking the unit or when moving the unit after unpacking, be sure to lift the unit by holding on to the hanger bracket without exerting any pressure on other parts, especially on refrigerant piping, drain piping and other resin parts.
- Refer to the installation manual of the outdoor unit for items not described in this manual.
- Caution concerning refrigerant series R410A:  
The connectable outdoor units must be designed exclusively for R410A.

## Precautions

- Do not install or operate the unit in places mentioned below.
  - Places with mineral oil, or filled with oil vapor or spray like in kitchens. (Plastic parts may deteriorate.)
  - Where corrosive gas like sulphurous gas exists. (Copper tubing and brazed spots may corrode.)
  - Where volatile flammable gas like thinner or gasoline is used.
  - Where machines generating electromagnetic waves exist. (Control system may malfunction.)
  - Where the air contains high levels of salt such as near the ocean and where voltage fluctuates a lot (e.g. in factories). Also inside vehicles or vessels.
- Do not install accessories on the casing directly. Drilling holes in the casing may damage electrical wires and consequently cause fire.
- Take off static electricity from the body when carrying out wiring and the electrical wiring box cover is removed. The electric parts may be damaged.

# Accessories

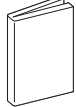
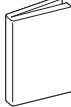
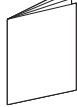
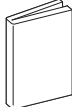
<p>(A) Clamp metal</p>  <p>1</p>	<p>(B) Drain hose</p>  <p>1</p>	<p>(C) Duct flange connection screw</p>  <p>10*</p>	<p>(D) Fitting insulation (for liquid pipe)</p>  <p>Thin</p> <p>1</p>
<p>(E) Fitting insulation (for gas pipe)</p>  <p>Thick</p> <p>1</p>	<p>(F) Sealing pad (large) (Dark gray)</p>  <p>1</p>	<p>(G) Sealing pad (medium) (Dark gray)</p>  <p>2</p>	<p>(H) Clamp</p>  <p>8</p>
<p>(J) Washer fixing plate</p>  <p>4</p>	<p>(K) Wire sealing pad (small) (Gray)</p>  <p>2</p>	<p>(L) Washer (for hanger bracket)</p>  <p>8</p>	<p>(M) Conduit mounting plate</p>  <p>1</p>
<p>(N) Operation manual</p>  <p>1</p>	<p>(P) Installation manual</p>  <p>1</p>	<p>(Q) Warranty</p>  <p>1</p>	<p>(R) General safety considerations</p>  <p>1</p>

\*The 15/18/24 class models have 18 screws.

## Optional Accessories

**A remote controller is required for the indoor unit.**

- There are 2 types of remote controllers: wired and wireless. Select a remote controller from the table according to user request and install in an appropriate place.

Remote controller type	Model name
Wired type	BRC1E73
Wireless type	BRC082A43

- If you wish to use a remote controller that is not listed in the table, select a suitable remote controller after consulting catalogs and technical materials.
- The indoor unit can be switched to lower suction. (Refer to “6. In the case of changing the preset suction to underside suction, replace the chamber cover and the suction flange.” (page 6))  
The side cover plate (KDBD63A160) is required in the case of wiring from the bottom for underside suction. For installation work, refer to the instruction sheet provided with the side cover plate.

# Choosing an Installation Site

Hold the unit by the 4 hanger brackets when opening the box and moving it, and do not exert pressure on to any other part, piping (refrigerant, drain, etc.), and air outlet flange.

If the temperature or humidity inside the ceiling might rise above 86°F (30°C) or RH 80%, respectively, add extra insulation to the unit.

Use polyethylene foam as insulation and make sure it is at least 3/8 inch (10mm) thick and fits inside the ceiling opening.

- Before choosing the installation site, obtain user approval. The indoor unit should be positioned in a place where:
  - 1) both the air inlet and air outlet are unobstructed,
  - 2) the unit is not exposed to direct sunlight,
  - 3) the unit is away from the source of heat or steam,
  - 4) there is no source of machine oil vapor (this may shorten the indoor unit service life),
  - 5) cool/warm air is circulated throughout the room,
  - 6) the unit is away from electronic ignition type fluorescent lamps (inverter or rapid start type) as they may affect the remote controller range,
  - 7) no laundry equipment is nearby,
  - 8) drainage can be performed without any problem,
  - 9) the weight of the indoor unit can be adequately supported,
  - 10) the wall and the ceiling's lower surface are not significantly tilted,
  - 11) room can be left for installation and service work,
  - 12) there is no risk of flammable gas leaking,
  - 13) the required length of indoor-outdoor piping would not exceed the specified maximum length (see the installation manual that came with the outdoor unit for details).

### [ Installation Space Requirements ]

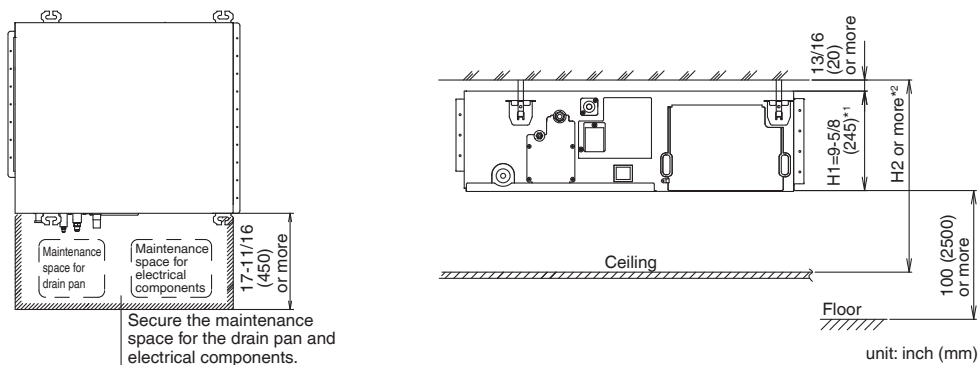

\*1 Dimension H1 indicates the product height.

\*2 Secure a downward slope of at least 1/100 specified in "8. Drain piping work" (page 8) and determine dimension H2.

**<Failure example>**  
 If there is an obstacle in the airflow path or proper installation space is not provided, the indoor unit will cause air volume reduction and take in air blown out of the indoor unit, thus resulting in performance degradation or turning the thermostat OFF frequently.

**Use suspension bolts for installation. Check whether the ceiling is strong enough to support the weight of the unit or not. If there is a risk, reinforce the ceiling before installing the unit.**

# Indoor Unit Installation

## 1. Check the relation of location between the ceiling opening and the indoor unit suspension bolts. (unit: inch (mm))

Provide one of the following service spaces for the maintenance and inspection of the electrical wiring box and drain pump or for other services.

**If a space of 300mm or more under the product can be secured**

- Inspection ports 1 and 2 (17-11/16 inch (450mm) × 17-11/16 inch (450mm)) and a minimum space of 11-13/16 inch (300mm) at the bottom of the product.

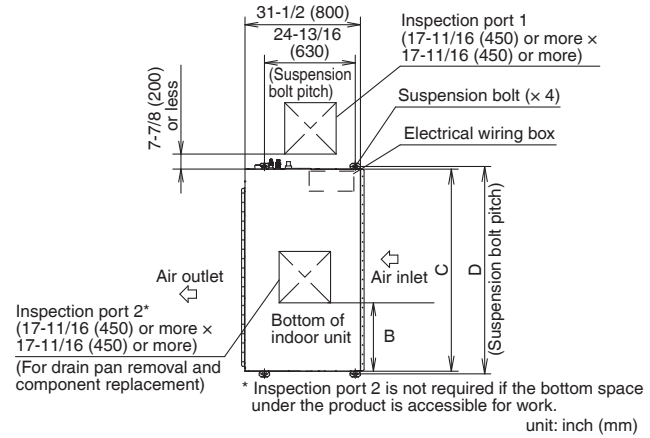
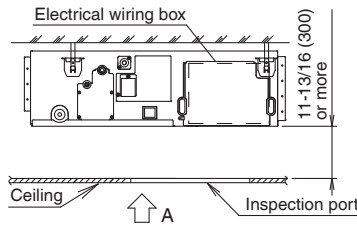

View A

**If a space of 300mm or more under the product can not be secured**

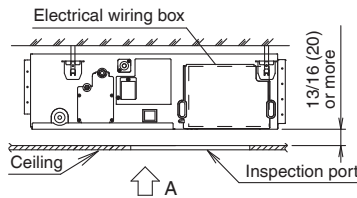

- 1) Inspection port 1 (17-11/16 inch (450mm) × 17-11/16 inch (450mm)) on the electrical wiring box side and inspection port 2 on the bottom of the product. (View A-1))

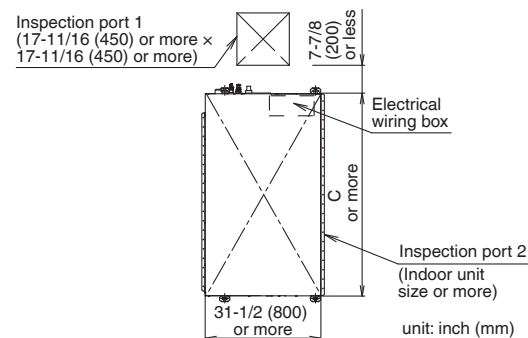

View A-1)

- 2) Inspection port 3 on the bottom of the product and on the bottom side of the electrical wiring box. (View A-2))

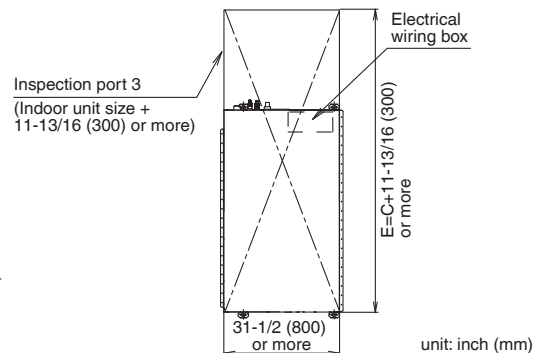

View A-2)

	B	C	D	E
07/09/12 class	(0)	27-9/16 (700)	29-1/16 (738)	39-3/8 (1000)
15/18/24 class	1-15/16 (50)	39-3/8 (1000)	40-7/8 (1038)	51-3/16 (1300)

unit: inch (mm)



## 2. Mount canvas ducts, sound absorbing material and anti-vibration rubber.

- Mount canvas ducts to the air outlet and inlet so that the vibration of the indoor unit will not be transmitted to the ducts or ceiling.  
Furthermore, attach sound absorbing material (thermal insulation material) to the duct inner walls and anti-vibration rubber to the suspension bolts (refer to “10. Duct work” (page 15)).

## 3. The indoor unit is set to standard external static pressure.

- If external static pressure is higher or lower than the standard set value, the remote controller may be used to make on-site setting change in the external static pressure.  
Refer to “Field settings” (page 18).

## 4. Open installation holes (in the case of installation onto the existing ceiling).

- Open the installation holes on the ceiling of the installation location, and work on the refrigerant piping, drain piping, remote controller wiring, and wiring between the indoor and outdoor units to the piping connection port and wiring connection port of the indoor unit (refer to each piping and wiring procedure items).
- Ceiling framework reinforcement may be required in order to keep the ceiling horizontal and prevent ceiling vibration after opening the ceiling holes. For details, consult your building and upholstery work contractors.

## 5. Installing the suspension bolts

(Use either a M8-M10 size bolt or the equivalent)  
Use a hole-in anchor for existing ceilings, and a sunken insert, sunken anchor or other field supplied parts for new ceilings to reinforce the ceiling to bear the weight of the unit.  
Adjust clearance (2-4 inch (50-100mm)) from the ceiling before proceeding further.

- All the above parts are field supplied.

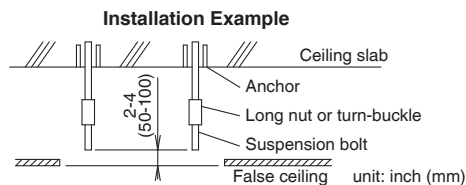

## 6. In the case of changing the preset suction to underside suction, replace the chamber cover and the suction flange.

1. Remove the suction flange and chamber cover.
2. Replace the suction flange and the chamber cover.

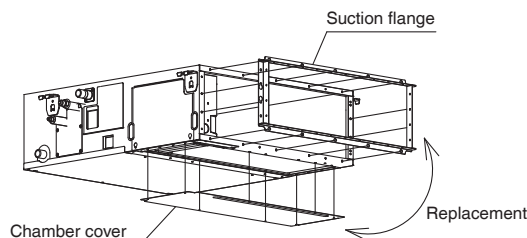

### ⚠ CAUTION

- Secure a sufficient maintenance space for the drain pan and electrical components before installing the indoor unit.
- Secure a sufficient maintenance space for the filter chamber, and peripheral components before installing the indoor unit.

# Indoor Unit Installation

## 7. Installing the indoor unit

When installing optional accessories, read also the installation manual of the optional accessories. Depending on the field conditions, it may be easier to install optional accessories before the indoor unit is installed.

As for the parts to be used for installation work, be sure to use the provided accessories and specified parts designated by Daikin.

- 1) Install the indoor unit temporarily.
  - Attach the hanger bracket to the suspension bolt. Be sure to fix it securely by using a nut and (L) washer from the upper and lower sides of the hanger bracket.
    - If the (J) washer fixing plate is used, the upper side (L) washer may be protected from falling off.

### Securing the hanger bracket

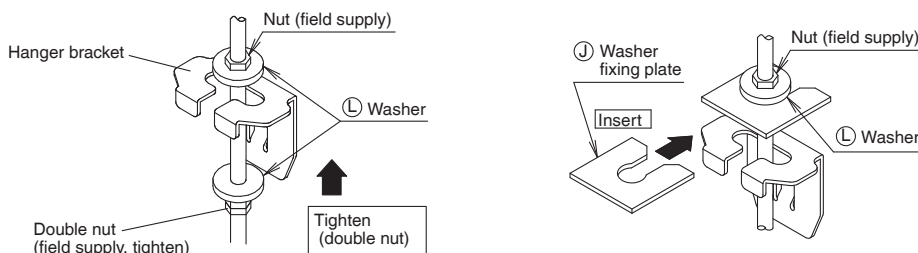

- Keep the air outlet covered with a protective sheet to prevent weld spatter and other foreign materials from entering the indoor unit and damaging the resin drain pan. (If holes or cracks are generated in the resin drain pan, water can leak.)
- 2) Adjust the height of the unit.
  - 3) Check the unit is horizontally level.

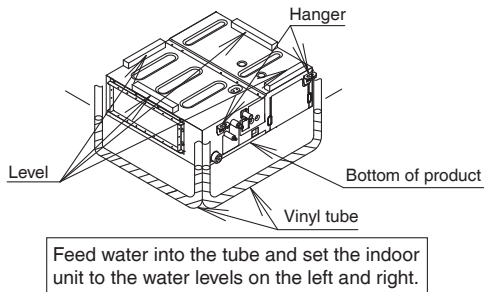

- 4) Remove the (J) washer fixing plate used for preventing the (L) washer from dropping and tighten the upper side nut.

### ⚠ CAUTION

- **Install the indoor unit leveled.**  
If the indoor unit is inclined and the drain piping side gets high, it may cause malfunction of float switch and result in water leakage.
- **Attach nuts on the upper and lower side of hanger.**  
If there is no upper nut and the lower nut is over-tightened, the hanger and the top plate will deform and cause abnormal sound.
- **Do not insert materials other than that specified into the clearance between the hanger and the washer for hanger bracket (11).**  
Unless the washers are properly attached, the suspension bolts may come off from the hanger.

### ⚠ WARNING

**The indoor unit must be securely installed on a place that can withstand the mass.**  
If the strength is insufficient, the indoor unit may fall down and cause injuries.

## 8. Drain piping work

### ⚠ CAUTION

- Water pooling in the drainage piping can cause the drain to clog.
- Do not connect the drain piping directly to sewage pipes that smell of ammonia. The ammonia in the sewage might enter the indoor unit through the drain pipes and corrode the heat exchanger.
- Keep in mind that the drain pipe becomes blocked if water collects on it.
- Do not tighten the (A) clamp metal with the torque more than the specified value. The (B) drain hose, the socket or the (A) clamp metal may be damaged.

### 1. Install of drain piping

- Install the drain piping as shown in the figure and take measures against condensation. Improperly rigged piping could lead to leaks and eventually wet furniture and belongings.
- Keep piping as short as possible and slope it downwards at a gradient of at least 1/100 so that air may not remain trapped inside the pipe.
- Select the piping diameter equal to or larger than (except for riser) that of the connection piping (polyvinyl chloride piping, nominal diameter 1 inch (25mm), outside diameter 1-1/4 inch (32mm)).
- If the drain hose cannot be sufficiently set on a slope, refer to “Precautions for drain raising piping” (page 9).
- To keep the drain hose from sagging, space hanger bracket every 40-60 inch (1000-1500mm).

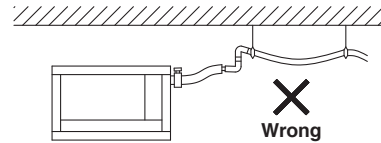
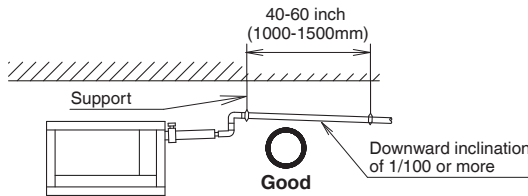

- Make sure to use the attached (B) drain hose and the (A) clamp metal. Insert the (B) drain hose into the drain socket up to the point where the socket diameter becomes larger. Put the (A) clamp metal to the taped hose end and tighten the (A) clamp metal with torque 10.6~13.3lbf • ft (120~150 N•cm).

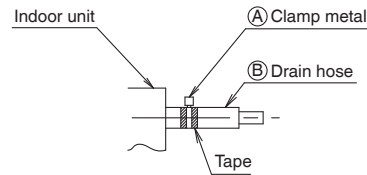

- Wrap the vinyl tape around the end of the (A) clamp metal so that the (F) sealing pad (Large) to be used at the next process may not be damaged with the clamp end or bend the tip of the (A) clamp metal inward as shown.

#### <In case of sticking vinyl tape>

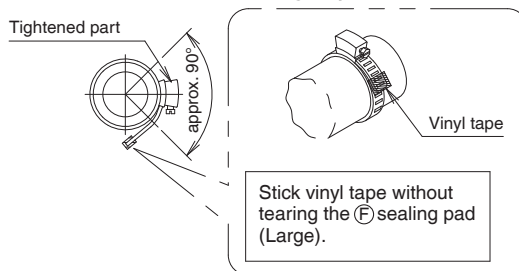

#### <In case of bending the tip>

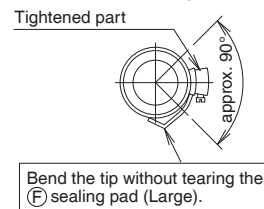

# Indoor Unit Installation

## Precautions for drain raising piping

- The maximum height of the drain riser is 29-9/16 inch (675mm). Since the drain pump mounted on this indoor unit is a high head type, from the characteristic point of view, the higher the drain riser the lower the draining noise. Therefore, the drain riser of 11-13/16 inch (300mm) or higher is recommended.
- For upward drain piping, keep the horizontal piping distance of 11-13/16 inch (300mm) or less between the drain socket root to the drain riser.

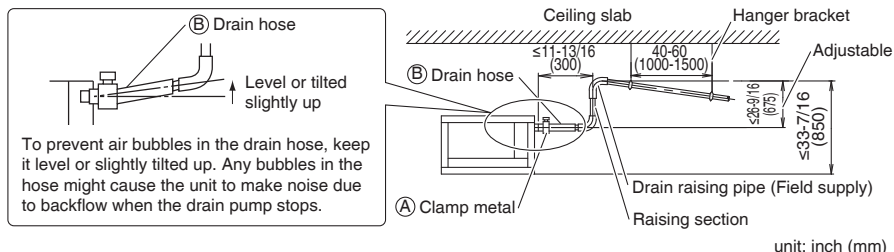

- To ensure no excessive pressure is applied to the included (B) drain hose, do not bend or twist the hose when installing as it could cause leakage.
- If converging multiple drain pipes, install according to the procedure shown below.

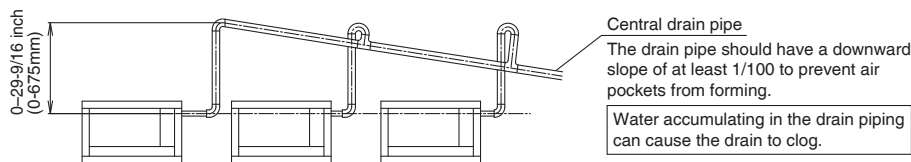

Select converging drain pipes with gauges is suitable for the operating capacity of the unit.

- Positioning the upward drain piping at an angle may cause float switch malfunction and lead to water leakage.
- While replacing with new indoor unit, use the attached new (B) drain hose and the (A) clamp metal. If an old drain hose or a clamp metal is used, it may cause water leakage.

## 2. After piping work is finished, check if drainage flows smoothly

### When electric wiring work is finished

- Gradually pour 1/4 gal of water from the inspection port at the bottom of the drain socket on the left side of the drain socket into the drain pan giving caution to avoid splashing water on the electric components such as drain pump and confirm drainage by operating the indoor unit under cooling mode according to **Field settings**.

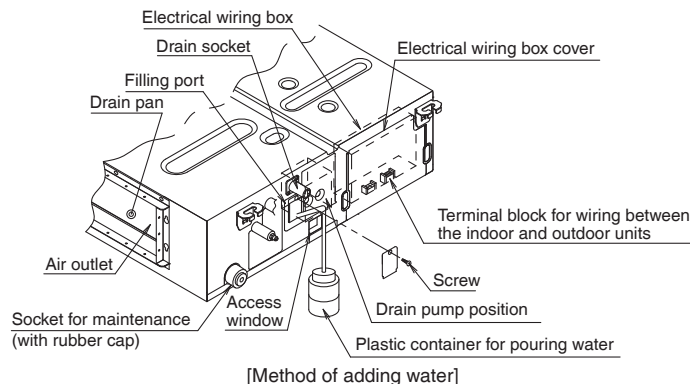

**When electric wiring work is not finished**

- The electric wiring works (including grounding) must be carried out by a qualified electrician.
- If a qualified person is not present, after the electric wiring work is finished, check the drainage according to the method specified in [When the electric wiring work is finished].
  1. Open the electrical wiring box cover and connect the ground wiring to the ground terminal.
  2. Make sure the electrical wiring box cover is closed before turning on the power supply.
    - Throughout the whole process, carry out the work giving caution to the wiring around the electrical wiring box so that the connectors may not come off.
  3. Gradually pour 1 litre of water from the air outlet on the left side of the drain socket into the drain pan giving caution to avoid splashing water on the electric components such as drain pump.
  4. When the power supply is turned on, the drain pump will operate. Drainage can be checked at the transparent part of the drain socket.
 

(The drain pump will automatically stop after 10 minutes.)

The drainage of water can be confirmed with water level change in the drain pan through the access window.

    - Do not connect the drain piping directly to the sewage that gives off ammonia odor. The ammonia in the sewage may go through the drain piping and corrode the heat exchanger of the indoor unit.
    - Do not apply external force to the float switch. (It may result in malfunction)
    - Do not touch the drain pump. Touching the drain pump may cause electric shock.
  5. Turn off the power supply after checking drainage, and remove the power supply wiring.
  6. Attach the electrical wiring box cover as before.

**3. Sweating may occur and result in water leakage. Therefore, make sure to insulate the following 2 locations (drain piping that laid indoors and drain sockets).**

- Use the provided (F) sealing pad (large), and perform the thermal insulation of the (A) clamp metal and (B) drain hose after checking the drainage of water.

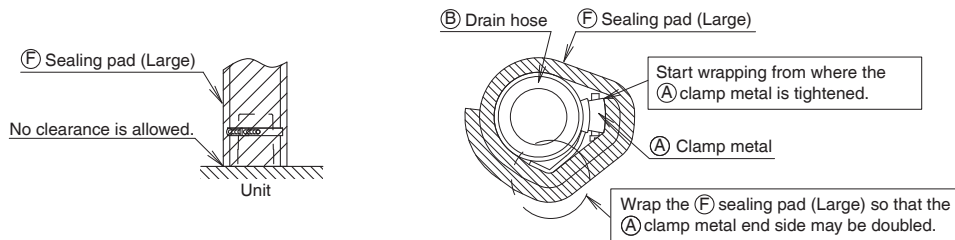

# Indoor Unit Installation

## 9. Wiring

### 1. General instructions

- Make certain that all electric wiring work is carried out by qualified personnel according to the applicable legislation and this installation manual, using a separate dedicated circuit. Insufficient capacity of the power supply circuit or improper electrical construction may lead to electric shock or a fire.
- Make sure to install a ground fault circuit interrupter. Failure to do so may cause electric shock and a fire.
- Do not turn on the power supply (branch switch, branch overcurrent circuit breaker) until all the works are finished.
- Multiple number of indoor units are connected to one outdoor unit. Name each indoor unit as A-unit, B-unit ..... and the like. When these indoor units are wired to the outdoor unit, always wire the indoor unit to the terminal indicated with the same symbol on the terminal block. If the wiring and the piping are connected to the different indoor units and operated, it will result in malfunction.
- Make sure to ground the air conditioner. Grounding resistance should be according to applicable legislation.
- Do not connect the ground wiring to gas or water pipings, lightning conductor or telephone ground wiring.
  - Gas piping .....Ignition or explosion may occur if the gas leaks.
  - Water piping.....Hard vinyl tubes are not effective grounds.
  - Lightning conductor or telephone ground wiring.....Electric potential may rise abnormally if struck by a lightning bolt.
- For electric wiring work, refer to also the "WIRING DIAGRAM" attached to the electrical wiring box cover.
- Carry out wiring between the outdoor units, indoor units and the remote controllers according to the wiring diagram.
- Carry out installation and wiring of the remote controller according to the "installation manual" attached to the remote controller.
- Do not touch the Printed Circuit Board assembly. It may cause malfunction.

### ⚠ WARNING

- Do not use tapped wires, extension cords, or starburst connections, as they may cause overheating, electric shock, or fire.
- Do not use locally purchased electrical parts inside the product. (Do not branch the power for the drain pump, etc., from the terminal block.) Doing so may cause electric shock or fire.
- Do not connect the power wire to the indoor unit. Doing so may cause electric shock or fire.

### ⚠ CAUTION

- When clamping wiring, use the included clamping material to prevent outside pressure being exerted on the wiring connections and clamp firmly. When doing the wiring, make sure the wiring is neat and does not cause the electrical wiring box cover to stick up, then close the cover firmly.
- Outside the unit, separate the low voltage wiring (remote controller wiring) and high voltage wiring (wiring between units, ground, and other power wiring) at least 2 in. so that they do not pass through the same place together. Proximity may cause electrical interference, malfunctions, and breakage.

### 2. Wiring example

For the wiring of outdoor units, refer to the installation manual attached to the outdoor units.

#### Confirm the system type.

- **Multi system:** 2 through 6 (The number of connectable units will vary according to model) indoor units connect to 1 outdoor unit. The indoor unit is controlled by remote controller connected to each indoor unit.

### NOTE

1. All transmission wiring except for the remote controller wires is polarized and must match the terminal symbol.
2. In case a shielding wire is to be used, connect a shielded portion with the ⚡ of a remote controller terminal block.(Also, connect the ground for the remote control to a grounded metal part.)

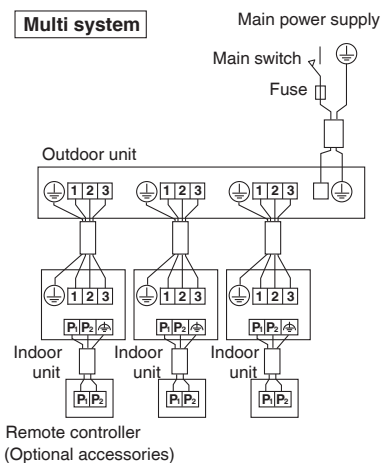

### 3. Specification for field wire

	Wire	Size	Length
Wiring between units	Recommend stranded and shielded. Local code supersedes recommendation.	AWG 14	-
Remote controller wiring	Sheathed (2 wire)	AWG 18 - 16	Max. 1640ft (500m)*
Wiring to ground terminal	Recommend stranded and shielded. Local code supersedes recommendation.	-	-

\* This will be the total extended length in the system when doing group control.

### 4. Wiring connection method

#### **⚠ CAUTION FOR WIRING**

Recommend stranded cable for interunit wiring. Local code always supersedes recommendation.

- For stranded wires, make sure to use the round crimp-style terminal for connection to the power supply terminal block. Place the round crimp-style terminals on the wires up to the covered part and secure in place.

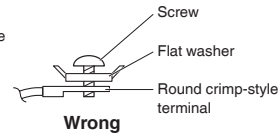
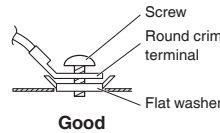
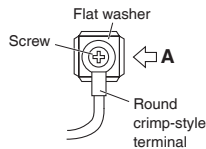
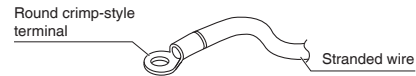

Arrow view A

- If solid core wire must be used, be sure to curl the end of the lead. Improper work may cause heat and fire.

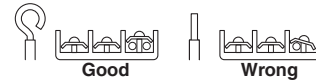

#### Tightening torque for the terminal blocks

- Use the correct screwdriver for tightening the terminal screws. If the blade of screwdriver is too small, the head of the screw might be damaged, and the screw will not be properly tightened.
- If the terminal screws are tightened too hard, screws might be damaged.
- Refer to the table below for the tightening torque of the terminal screws.

unit: lbf • ft (N • m)

	Tightening torque
Terminal block for remote controller (6P)	0.58 - 0.72 (0.79 - 0.98)
Terminal block for power supply (4P)	0.87 - 1.06 (1.18 - 1.44)

#### **⚠ WARNING**

- When wiring, form the wirings orderly so that the electrical wiring box cover can be securely fastened. If the electrical wiring box cover is not in place, the wirings may come out or be sandwiched by the box and the lid and cause electric shock or a fire.

- 1) Remove the electrical wiring box cover.

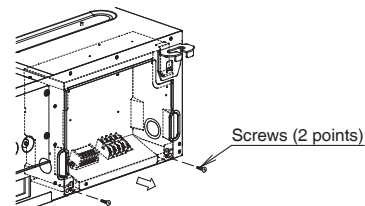

# Indoor Unit Installation

2) Attach the conduit to the (M) conduit mounting plate.

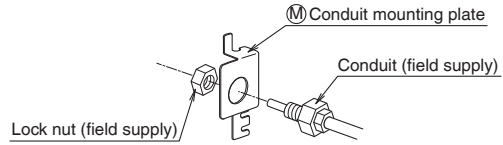

- Attach the (K) wire sealing pad (small) to the conduit, the wiring between the indoor and outdoor units, and the ground wiring.

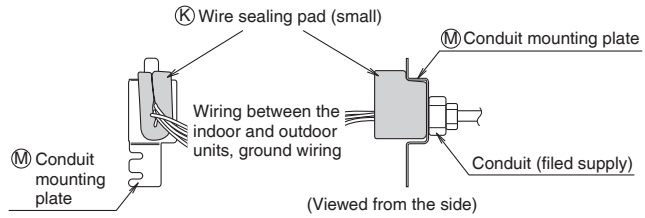

- Loosen the screws (2 points) in part A.

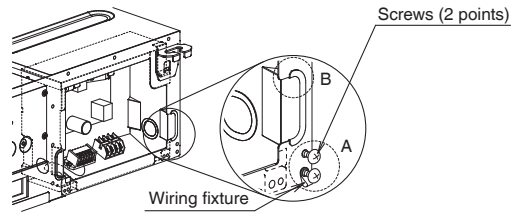

- Insert the hook part of the (M) conduit mounting plate into part B and secure the (M) conduit mounting plate with the screws loosened (2 points).

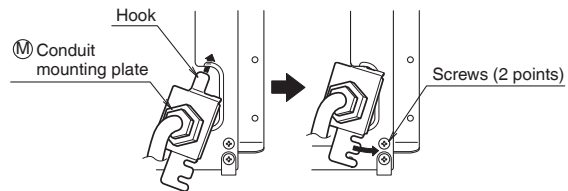

**NOTE**

Remove the wiring fixture if you have difficulty performing this step.

3) Connect the wiring into the electrical wiring box through the wiring intake beside the electrical wiring box.

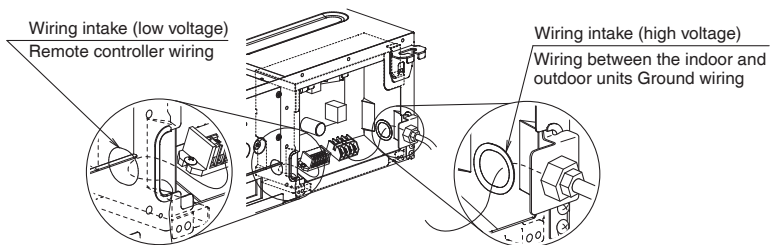



4) Follow the instructions below and perform wiring in the electrical wiring box.

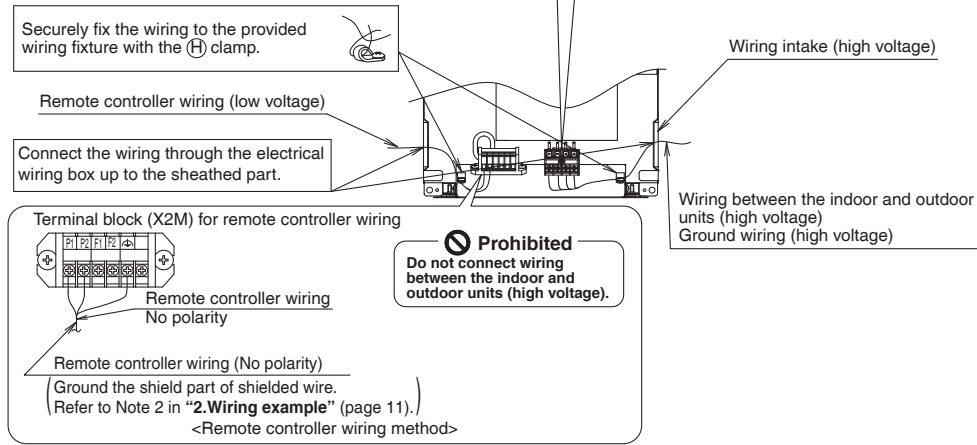
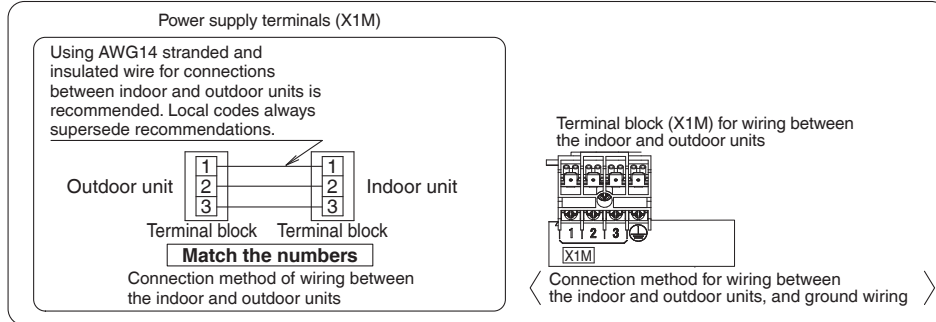

**NOTE**

Secure the wiring between the wiring intake and conduit with the (H) clamp so that the wiring will not become loose.

5) Mount the electrical wiring box cover and wrap the (K) wire sealing pad (small) so that the wiring through hole will be covered by the sealing pad.

- Seal the clearance around the wirings with putty or insulating material (field supply). (If insects and small animals get into the indoor unit, short-circuiting may occur inside the electrical wiring box.)

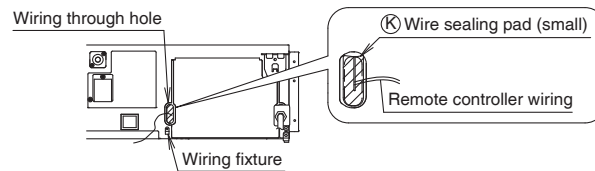

6) Securely fix each wiring with the provided (H) clamp material.

- See the installation manual supplied with the outdoor unit.

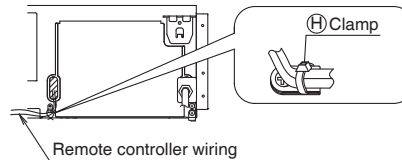

# Indoor Unit Installation

## 10. Duct work

**Pay the utmost attention to the following items and conduct the duct work.**

- Check that the duct is not in excess of the setting range of external static pressure for the unit. (Refer to the technical datasheet for the setting range.)
- Attach a canvas duct each to the air outlet and air inlet so that the vibration of the equipment will not be transmitted to the duct or ceiling.  
Use a sound-absorbing material (insulation material) for the lining of the duct and apply vibration insulation rubber to the suspension bolts.
- At the time of duct welding, perform the curing of the duct so that the sputter will not come in contact with the drain pan for the filter.
- If the metal duct passes through a metal lath, wire lath, or plate of a wooden structure, separate the duct and wall electrically.
- Be sure to heat insulate the duct for the prevention of dew condensation. (Material: Glass wool or styrene foam; Thickness: 1 inch (25mm))
- Be sure to attach the field supply air filter to the air inlet of the unit or field supply inlet in the air passage on the air suction side. (Be sure to select an air filter with a duct collection efficiency of 50 weight percent.)
- Explain the operation and washing methods of the locally procured components (i.e., the air filter, air inlet grille, and air outlet grille) to the user.
- Locate the air outlet grille on the indoor side for the prevention of drafts in a position where indirect contact with people.
- The air conditioner incorporates a function to adjust the fan to rated speed automatically. (Field settings)  
Therefore, do not use booster fans midway in the duct.

**Connection method of ducts on air inlet and outlet sides.**

- Connect the field supply duct in alignment with the inner side of the flange.
- Connect the flange and unit with the © duct flange connection screw.
- Wrap aluminium tape around the flange and duct joint in order to prevent air leakage.
- Do not create air outlets in multiple rooms for 1 unit.

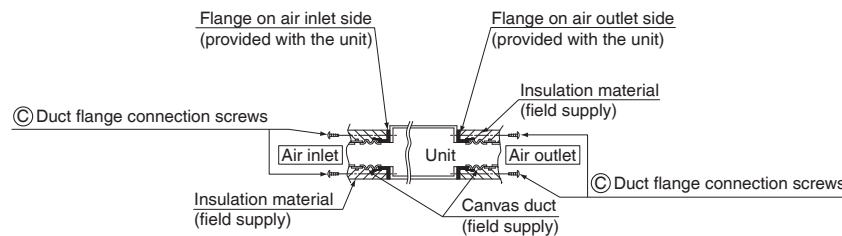

### **⚠ CAUTION**

Connect the flange and unit with the © duct flange connection screw regardless of whether the duct is connected to the air inlet side.

# Refrigerant Piping Work

Refer also to the installation manual for the outdoor unit.

## ⚠ WARNING

- Do not apply mineral oil on flared part.
- Prevent mineral oil from getting into the system as this would reduce the service life of the units.
- Never use piping which has been used for previous installations. Only use parts which are delivered with the unit.
- Never install a dryer to this R410A unit in order to guarantee its service life.
- The drying material may dissolve and damage the system.
- Incomplete flaring may result in refrigerant gas leakage.

Execute thermal insulation work completely on both sides of the gas and the liquid piping. Otherwise, a water leakage can result sometimes.

For gas piping, use insulation material of which heat resistant temperature is not less than 230°F (110°C).

Also, in cases where the temperature and humidity of the refrigerant piping sections might exceed 86°F (30°C) or RH80%, reinforce the refrigerant insulation. (13/16 inch (20mm) or thicker) Condensation may form on the surface of the insulating material.

Before refrigerant piping work, check which type of refrigerant is used. Proper operation is not possible if the types of refrigerant are not the same.

## 1. Flaring the pipe end

- 1) Cut the pipe end with a pipe cutter.
- 2) Remove burrs with the cut surface facing downward, so that the filings do not enter the pipe.



- 3) Put the flare nut on the pipe.
- 4) Flare the pipe.
- 5) Check that the flaring has been done correctly.

Flaring

Set exactly at the position shown below.

Flare tool for R32 or R410A	Conventional flare tool		
	Clutch-type	Clutch-type (Rigid-type)	Wing-nut type (Imperial-type)
A	0-0.020 inch (0-0.5mm)	0.039-0.059 inch (1.0-1.5mm)	0.059-0.079 inch (1.5-2.0mm)

Check

The flare's inner surface must be flaw-free.

The pipe end must be evenly flared in a perfect circle.

When flaring, do not over-tighten and crack.

Make sure that the flare nut is fitted.

## 2. Refrigerant piping

### ⚠ CAUTION

- Use the flare nut fixed to the main unit. (This is to prevent the flare nut from cracking as a result of deterioration over time.)
- To prevent gas leakage, apply refrigeration oil only to the inner surface of the flare. (Use refrigeration oil for R410A.)
- Use a torque wrench when tightening the flare nuts to prevent damage to the flare nuts and gas leakage.
- Do not have oil adhere to the screw fixing part of resin parts. If oil adheres, it may weaken the strength of screwed part.

- Align the centers of both flares and tighten the flare nuts 3 or 4 turns by hand, then tighten them fully with a spanner and a torque wrench.

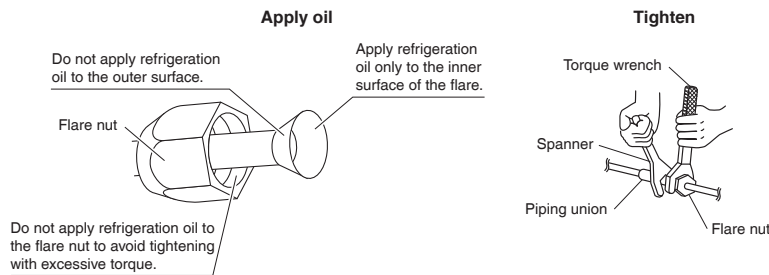

	Piping size	Flare nut tightening torque
Gas side	O.D. 3/8 inch (9.5mm)	24-1/8-29-1/2lbf • ft (32.7-39.9N • m)
	O.D. 1/2 inch (12.7mm)	36-1/2-44-1/2lbf • ft (49.5-60.3N • m)
	O.D. 5/8 inch (15.9mm)	45.6-55.6lbf • ft (61.8-75.4N • m)
Liquid side	O.D. 1/4 inch (6.4mm)	10-1/2-12-3/4lbf • ft (14.2-17.2N • m)

# Refrigerant Piping Work

## Cautions on piping handling

- Protect the open end of the pipe from dust and moisture.
- All pipe bends should be as gentle as possible. Use a pipe bender for bending.

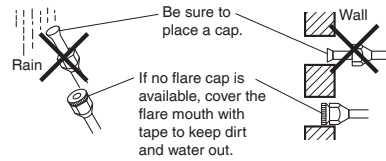

## Selection of copper and heat insulation materials

When using commercial copper pipes and fittings, observe the following:

- Insulation material: Polyethylene foam  
Heat transfer rate: 0.041 to 0.052W/mK (0.024 to 0.030Btu/ft<sup>h</sup>°F (0.035 to 0.045kcal/mh°C))  
Be sure to use insulation that is designed for use with HVAC Systems.
- ACR Copper pipe only.

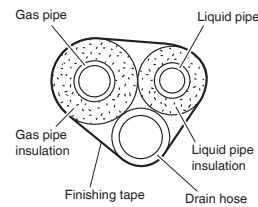

- Be sure to insulate both the gas and liquid piping and observe the insulation dimensions as below.

	Piping size	Minimum bend radius	Piping thickness	Thermal insulation size	Thermal insulation thickness
Gas side	O.D. 3/8 inch (9.5mm)	1-3/16 inch (30mm) or more	0.031 inch (0.8mm) (C1220T-O)	I.D. 15/32-19/32 inch (12-15mm)	13/32 inch (10mm) Min.
	O.D. 1/2 inch (12.7mm)	1-9/16 inch (40mm) or more		I.D. 9/16-5/8 inch (14-16mm)	
	O.D. 5/8 inch (15.9mm)	1-15/16 inch (50mm) or more	0.039 inch (1.0mm) (C1220T-O)	I.D. 5/8-13/16 inch (16-20mm)	
Liquid side	O.D. 1/4 inch (6.4mm)	1-3/16 inch (30mm) or more	0.031 inch (0.8mm) (C1220T-O)	I.D. 5/16-13/32 inch (8-10mm)	

- Use separate thermal insulation pipes for gas and liquid refrigerant pipes.
- Make absolutely sure to execute thermal insulation works on the pipe-connecting section, after checking for gas leakage, by thoroughly studying the following figures and using the included thermal insulating materials (D) fitting insulation and (E) fitting insulation. Fasten both ends with the (H) clamps.
- Make sure to bring the seam of (D) fitting insulation and (E) fitting insulation to the top.

## Piping insulation procedure

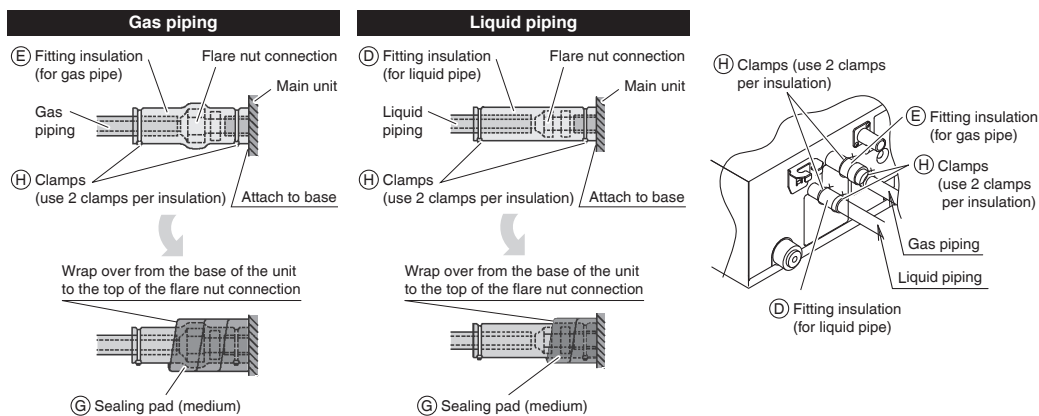

## CAUTION

Be sure to insulate any field piping all the way to the piping connection inside the unit. Any exposed piping may cause condensation or burns if touched.

# Field Settings

## ⚠ CAUTION

Before carrying out field setting, check the items mentioned in “2. Test items” (page 21).

- Check if all the installation and piping works for the air conditioner are completed.
- Check that the outside panel and piping cover of the indoor and outdoor units are closed.

**After turning on the power supply, carry out field setting from the remote controller according to the installation state.**

- The settings shown by  in the following tables indicate those when shipped from the factory.
- Carry out setting at 3 places, “Mode No.,” “FIRST CODE No.” and “SECOND CODE No.”.
- The method of setting procedure and operation is shown in the installation manual attached to the remote controller.
- Ask the user to keep the manual attached to the remote controller together with the operation manual.
- Do not carry out settings other than those shown in the table.

## NOTE

- Though setting of “Mode No.” is carried out as a group, if you intend to carry out individual setting by each indoor unit or confirmation after setting, carry out setting with the Mode No. shown in the parenthesis ( ).

## 1. Setting remote controller

### When using wireless remote controllers

- When using the wireless remote controllers, wireless remote controller address setting is necessary. Refer to the installation manual attached to the wireless remote controller.

## 2. Settings for external static pressure

Make settings in either method (a) or method (b).

### (a) Make settings with Air volume automatic adjustment function.

“Air volume automatic adjustment” function: The air volume is adjusted to the rated air volume automatically.

## ⚠ CAUTION

- Be sure to check that the external static pressure is within the specification range before making settings. The external static pressure will not be automatically adjusted and air volume insufficiency or water leakage may result if the external static pressure is outside the range. (Refer to the technical document for the setting range of external static pressure.)

- 1) Check that the electrical wiring and duct work have been completed.  
(If the closing damper is set midway, be sure to check that the damper is opened. Furthermore, check that the air passage on the suction side is provided with an air filter (field supply)).
- 2) If air conditioner has more than one air outlet and air inlet, be sure to make adjustments so that the air volume ratio of each air outlet and the corresponding air inlet will conform to the designed air volume ratio.  
In that case, set the operating mode to “Fan”. (In the case of changing the air volume, press the fan speed button on the remote controller and change the current selection to “High”, “Medium”, or “Low”.)
- 3) Make settings to adjust the air volume automatically.  
After setting the operating mode to “Fan”, set the air conditioner to field setting mode with the operation of the air conditioner stopped. Select Mode No. [21] (11 in the case of batch settings), select FIRST CODE No. “7”, and set the SECOND CODE No. to “03”.  
Return to the “Basic screen” (“Normal mode” if a wireless remote controller is used), and press the ON/OFF button. The operation lamp is lit, and the indoor unit will go into fan operation for air volume automatic adjustments (at which time, do not adjust the opening of the air outlet or inlet). The air volume adjustments will automatically terminate approximately 1 to 15 minutes after the indoor unit comes into operation, and the operation lamp will be OFF and the indoor unit will come to a stop.

### Air volume adjustment

Setting content	Mode No.	FIRST CODE No.	SECOND CODE No.
OFF			01
Air volume adjustment completion	11 (21)	7	02
Air volume adjustment start			03

# Field Settings

## ⚠ CAUTION

- If airflow pathway changes, such as duct and air outlet changes, are made after air volume adjustments, be sure to make “Air volume automatic adjustment” again.
- If airflow pathway changes, such as duct and air outlet changes, are made after “Trial Operation and Testing” (page 20) or air conditioner relocation, contact your dealer.

### (b) Select external static pressure with the remote controller.

Check with Mode No. [21] per indoor unit that the SECOND CODE No. for the above “Air volume adjustment” is set to “01” (OFF). (The SECOND CODE No. is factory set to “01” (OFF).)  
Change the SECOND CODE No. by referring to the table below according to the external static pressure of the duct to be connected.

#### External static pressure

For 07/09/12 class

Setting content	Mode No.	FIRST CODE NO.	SECOND CODE NO.
0.12 in. WG (30Pa)	13 (23)	6	03
0.16 in. WG (40Pa)			04
0.20 in. WG (50Pa)			05
0.24 in. WG (60Pa)			06
0.28 in. WG (70Pa)			07
0.32 in. WG (80Pa)			08
0.36 in. WG (90Pa)			09
0.40 in. WG (100Pa)			10
0.44 in. WG (110Pa)			11
0.48 in. WG (120Pa)			12
0.52 in. WG (130Pa)			13
0.56 in. WG (140Pa)			14
0.60 in. WG (150Pa)			15

For 15/18/24 class

Setting content	Mode No.	FIRST CODE NO.	SECOND CODE NO.
0.20 in. WG (50Pa)	13 (23)	6	05
0.24 in. WG (60Pa)			06
0.28 in. WG (70Pa)			07
0.32 in. WG (80Pa)			08
0.36 in. WG (90Pa)			09
0.40 in. WG (100Pa)			10
0.44 in. WG (110Pa)			11
0.48 in. WG (120Pa)			12
0.52 in. WG (130Pa)			13
0.56 in. WG (140Pa)			14
0.60 in. WG (150Pa)			15

## 3. Setting for options

- For settings for options, see the installation manual provided with the option.

## 4. Setting air filter sign

- Remote controllers are equipped with liquid crystal display air filter signs to display the time to clean air filters.
- Change the SECOND CODE NO. depending on the amount of dirt or dust in the room.

### AIR FILTER CLEANING TIME INDICATOR lamp display interval

Setting content	Contamination	Mode No.	FIRST CODE NO.	SECOND CODE NO.
Approx. 2500 hrs	Contamination-light	10 (20)	0	01
Approx. 1250 hrs	Contamination-heavy			02

### AIR FILTER CLEANING TIME INDICATOR lamp display

Setting content	Mode No.	FIRST CODE NO.	SECOND CODE NO.
Display ON	10 (20)	3	01
Display OFF*			02

\* Use “Display OFF” setting when cleaning indication is not necessary such as the case of periodical cleaning being carried out.

## 5. When implementing group control

- When using as a pair unit, you may control up to 16 units with the remote controller.
- In this case, all the indoor units in the group will operate in accordance with the group control remote controller.
- Select a remote controller which matches as many of the functions (swing flap, etc.) in the group as possible.

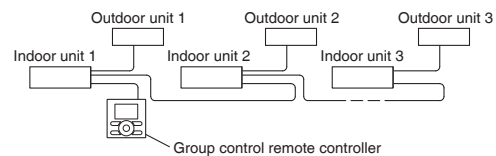

### Wiring Method

- 1) Remove the electrical wiring box cover.  
(Refer to 1) Remove the electrical wiring box cover in “9. Wiring” on page 12.)
- 2) Cross-wire the terminal block for remote controller (P1, P2) inside the electrical wiring box. (There is no polarity.)  
(Refer to 3. Specification for field wire in “9. Wiring” on page 12)

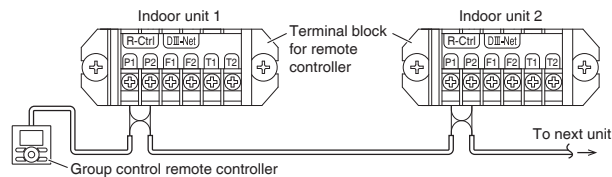

# Trial Operation and Testing

After finishing the construction of refrigerant piping, drain piping, and electric wiring, conduct trial operation accordingly to protect the unit.

## 1. Trial operation and testing

### ⚠ CAUTION

After test operation is completed, check the items mentioned “Items to be checked at time of delivery” (page 22).  
 If the interior finish work is not completed when the test operation is finished, for protection of the air conditioner, ask the user not operate the air conditioner until the interior finish work is completed.  
 If the air conditioner is operated, the inside of the indoor units may be polluted by substances generated from the coating and adhesives used for the interior finish work and cause water splash and leakage.

Trial operation should be carried out in either COOL or HEAT operation.

**1-1. Measure the supply voltage and make sure that it is within the specified range.**

**1-2. In COOL operation, select the lowest programmable temperature; in HEAT operation, select the highest programmable temperature.**

**1-3. Carry out the trial operation following the instructions in the operation manual to ensure that all functions and parts, such as the movement of the louvers, are working properly.**

- To protect the air conditioner, restart operation is disabled for 3 minutes after the system has been turned off.

**1-4. After trial operation is complete, set the temperature to a normal level (78°F to 82°F (26°C to 28°C) in COOL operation, 68°F to 75°F (20°C to 24°C) in HEAT operation).**

- When operating the air conditioner in COOL operation in winter, or HEAT operation in summer, set it to the trial operation mode using the following method.

Refer to **For wired remote controller**.

Refer to **For wireless remote controller** (page 21).

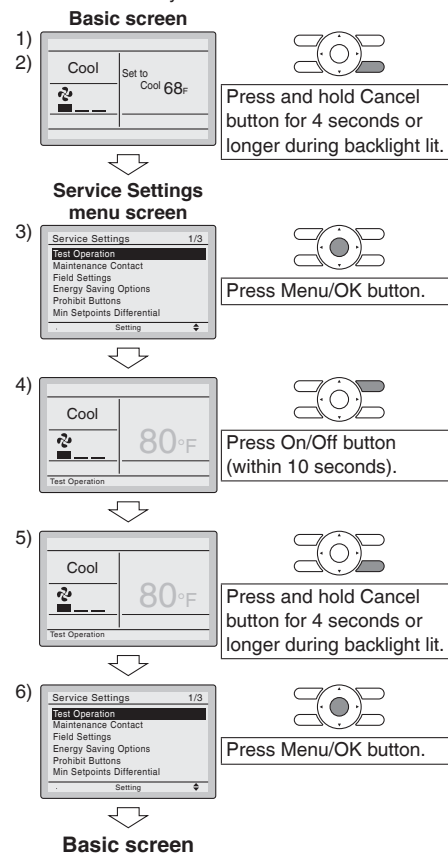

#### For wired remote controller

- Set to COOL or HEAT operation using the remote controller.
- Press and hold Cancel button for 4 seconds or longer. Service settings menu is displayed.
- Select **Test Operation** in the service settings menu, and press Menu/OK button. Basic screen returns and “Test Operation” is displayed at the bottom.
- Press On/Off button within 10 seconds, and the test operation starts.  
 Monitor the operation of the indoor unit for a minimum of 10 minutes. During test operation, the indoor unit will continue to cool/heat regardless of the temperature setpoint and room temperature.
  - In the case of above-mentioned procedures 3) and 4) in reverse order, test operation can start as well.
- Press and hold Cancel button for 4 seconds or longer in the basic screen. Service settings menu is displayed.
- Select **Test Operation** in the service settings menu, and press Menu/OK button. Basic screen returns and normal operation is conducted.
  - Test operation will stop automatically after 15-30 minutes. To stop the operation, press On/Off button.



# Trial Operation and Testing

**For wireless remote controller**

- 1) Press  and select the COOL or HEAT operation.
- 2) Press  twice. "Test" is displayed.
- 3) Press  within 10 seconds, and the test operation starts.

Monitor the operation of the indoor unit for a minimum of 10 minutes. During test operation, the indoor unit will continue to cool/heat regardless of the temperature setpoint and room temperature.

- In the case of above-mentioned procedures 1) and 2) in reverse order, test operation can start as well.
- Test operation will stop automatically after 15 - 30 minutes.

To stop the operation, press .

- Some of the functions cannot be used in the test operation mode.

**Precautions**

Refer to "3. How to diagnose for malfunction" (page 23) if the unit does not operate properly.

## 2. Test items

Test items	Symptom	Check
Indoor and outdoor units are installed securely.	Fall, vibration, noise	
No refrigerant gas leaks.	Incomplete cooling/heating function	
Refrigerant gas and liquid pipes and indoor drain hose extension are thermally insulated.	Water leakage	
Draining line is properly installed.	Water leakage	
The power supply voltage corresponds to that shown on the name plate.	No operation or burn damage	
System is properly grounded.	Electrical leakage	
Only specified wires are used for all wiring, and all wires are connected correctly.	No operation or burn damage	
Indoor or outdoor unit's air inlet or air outlet are unobstructed.	Incomplete cooling/heating function	
Refrigerant piping length and additional refrigerant charge are noted down.	The refrigerant charge in the system is not clear	
Pipes and wires are connected to the corresponding connection ports / terminal blocks for the connected unit.	No cooling/heating	
Stop valves are opened.	Incomplete cooling/heating function	
Indoor unit properly receives wireless remote control commands.	No operation	
The external static pressure is set correctly.	Incomplete cooling/heating function or water leakage	





**Items to be checked at time of delivery**

Also review the “Precautions” (page 3)

Test items	Check
The electrical wiring box cover and air filter are attached.	
I explained about operations while showing the operation manual to the user.	
Field setting has been carried out. (if necessary)	
It has been confirmed that the cool air discharges during the COOL operation and the warm air discharges during the HEAT operation. The indoor unit does not make unpleasant sounds of air discharge.	
I explained the set fan speed to the user (if the fan speed was set at thermostat OFF).	
I handed the operation manual over to the user.	
I have checked that there is no generation of abnormal noise (i.e., noise resulting from contamination or missing parts).	
The printed circuit board switch is not on the emergency (EMG.) side. The switch is factory set to the normal (NORM.) side.	
I have checked the operation of the optional accessory and made field settings as needed (if an optional accessory is in use).	
I have explained failure examples of “3.How to diagnose for malfunction” (page 23).	
I explained the power supply status (power supply ON/OFF) to the user.	

**Points for explanation about operations**

The items with  WARNING and  CAUTION marks in the operation manual are the items pertaining to possibilities for bodily injury and material damage in addition to the general usage of the product. Accordingly, it is necessary that you make a full explanation about the described contents and also ask your user to read the operation manual.

**Note to the installer**

Be sure to instruct user how to properly operate the unit (especially cleaning the filter, operating different functions, and adjusting the temperature) by having them carry out operations while looking at the manual.

 **To the operator carrying out test operation** \_\_\_\_\_  
 After test operation is completed, before delivering the air conditioner to the user, confirm that the electrical wiring box cover is closed.  
 In addition, explain the power supply status (power supply ON/OFF) to the user.

# Trial Operation and Testing

## 3. How to diagnose for malfunction

- If the air conditioner does not operate normally after installing the air conditioner, a malfunction shown in the table below may happen.

Wired remote controller display	Description
No display	<ul style="list-style-type: none"> <li>• Power outage, power voltage error or open-phase</li> <li>• Incorrect wiring (between indoor and outdoor units)</li> <li>• Indoor PC-board assembly failure</li> <li>• Remote controller wiring not connected</li> <li>• Remote controller failure</li> <li>• Open fuse or tripped circuit breaker (outdoor unit)</li> </ul>
"Checking the connection. Please stand by:"*	<ul style="list-style-type: none"> <li>• Indoor PC-board assembly failure</li> <li>• Wrong wiring (between indoor and outdoor units)</li> </ul>

\* "Checking the connection. Please stand by" will be displayed for up to 90 seconds following the application of power to the indoor unit. This is normal and does not indicate a malfunction.

- Diagnose with the display on the liquid crystal display remote controller.

### With the wired remote controller

When the operation stops due to a malfunction, operation lamp blinks, and the malfunction code is indicated on the liquid crystal display. In such a case, diagnose the fault contents by referring to **Error History** in the service settings menu. In the case of group control, the unit No. is displayed so that the indoor unit with the trouble can be identified.

### With the wireless remote controller

(Refer also to the operation manual attached to the wireless remote controller)

When the operation stops due to a malfunction the display on the indoor unit blinks. In such a case, diagnose the fault contents with the error code which can be found by following procedures.

- 1) Press the INSPECTION/TEST OPERATION button, "👁" is displayed and "0" blinks.
- 2) Press the TEMPERATURE SETTING button and find the unit No. which stopped due to trouble.
 

Number of beeps	3 short beeps.....	Perform all the following operations
	1 short beep .....	Perform (3) and (6)
	1 long beep.....	No trouble
- 3) Press the OPERATION MODE SELECTOR button and upper figure of the error code blinks.
- 4) Continue pressing the TEMPERATURE SETTING button until it makes 2 short beeps and find the upper code.
- 5) Press the OPERATION MODE SELECTOR button and lower figure of the error code blinks.
- 6) Continue pressing the TEMPERATURE SETTING button until it makes a long beep and find the lower code.
  - A long beep indicate the error code.

## 4. Malfunction code

- For places where the malfunction code is written in white, the "👁" indication is not displayed. Though the system continues operating, be sure to inspect the system and make repairs as necessary.
- Depending on the type of indoor or outdoor unit, the malfunction code may or may not be displayed.

Malfunction code	Descriptions and measures	Remarks
A1	Indoor Printed Circuit Board failure	
A3	Drain level abnormal	
A5	High pressure control or freeze-up protector	
A6	Indoor fan motor overload, over current, lock	
	Indoor Printed Circuit Board connection failure	
A8	Indoor unit power supply voltage abnormal	
AJ	Capacity setting failure	Capacity setting adapter or capacity data error, or disconnection of the capacity setting adapter, failure to connect the adapter, or the capacity is not set to the data-retention IC.

Malfunction code	Descriptions and measures	Remarks
C1	Transmission error between indoor Printed Circuit Board (Master) and indoor Printed Circuit Board (Slave)	
C4	Indoor heat exchanger liquid pipe temperature sensor malfunction	Abnormal stop is applied depending on the model or condition.
C5	Indoor heat exchanger condenser / evaporator temperature sensor malfunction	Abnormal stop is applied depending on the model or condition.
C9	Suction air thermistor malfunction	Abnormal stop is applied depending on the model or condition.
CJ	Remote controller air thermistor malfunction	Remote controller thermo does not function, but body thermo operation is enabled.
E0	Action of safety device (Outdoor unit)	
E1	Outdoor Printed Circuit Board failure (Outdoor unit)	
E3	High pressure switch (HPS) activated	Depending on the type of outdoor unit connected, the malfunction code may not be displayed.
E5	OL (compressor overload) started, high pressure switch (HPS) activated	Depending on the type of outdoor unit connected, the malfunction contents may be different.
E6	Compressor motor lock by over current (Outdoor unit)	
E7	Outdoor fan motor lock malfunction (Outdoor unit) Outdoor fan instant overcurrent malfunction (Outdoor unit)	
E8	Input overcurrent (Outdoor unit)	
EA	Cooling/heating switch malfunction (Outdoor unit)	
F3	Discharge piping temperature malfunction (Outdoor unit)	
F6	High pressure control (in cooling) (Outdoor unit)	
F8	Operation halt due to compressor internal temperature abnormality	
H0	Sensor fault for inverter (Outdoor unit)	
H6	Operation halt due to faulty position detection sensor	
H8	CT abnormality (Outdoor unit)	
H9	Outdoor air thermistor system malfunction (Outdoor unit)	Abnormal stop is applied depending on the model or condition.
J3	Discharge piping thermistor system malfunction (Outdoor unit)	Abnormal stop is applied depending on the model or condition.
J6	Outdoor heat exchanger distributor liquid piping thermistor malfunction (Outdoor unit)	Abnormal stop is applied depending on the model or condition.
L3	Reactor thermistor malfunction (Outdoor unit)	
L4	Overheated heat-radiating fin (Outdoor unit)	Inverter cooling failure.
L5	Instantaneous overcurrent (Outdoor unit)	The compressor engines and turbines may be experiencing a ground fault or short circuit.
P4	Heat-radiating fin thermistor malfunction (Outdoor unit)	Abnormal stop is applied depending on the model or condition.
U0	Suction piping temperature abnormal (Outdoor unit)	The refrigerant may be insufficient. Abnormal stop is applied depending on the model or condition.
U2	Power voltage malfunction (Outdoor unit)	The inverter open-phase or main circuit condenser may be malfunctioning. Abnormal stop is applied depending on the model or condition.
U4 UF	Transmission error (between indoor and outdoor units)	Wiring error between indoor and outdoor unit. Or Indoor and outdoor Printed Circuit Board failure.
U5	Transmission error (between indoor and remote controller units)	Transmission between indoor unit and remote controller is not performed properly.
U7	Transmission error of the inverter module	
UA	Field setting error	System setting error of the simultaneous on/off multi-split type.
UE	Transmission error (between indoor unit and centralized remote controller)	
UC	Remote controller address setting error	

12.5 RXL09/12

# Contents

<b>Safety Considerations</b> .....	1	4. Refrigerant piping .....	6
<b>Accessories</b> .....	3	5. Pressure test and evacuating system.....	7
<b>Precautions for Selecting a Location</b> .....	3	6. Refilling refrigerant .....	8
<b>Precautions on Installation</b> .....	4	<b>Wiring</b> .....	9
<b>Outdoor Unit Installation Diagram</b> .....	4	<b>Facility Setting</b>	
<b>Installation Space Requirements</b> .....	5	<b>(cooling at low outdoor temperature)</b> .....	10
<b>Outdoor Unit Installation</b> .....	5	<b>When Attaching the Drain Pan Heater</b> .....	11
1. Installing the outdoor unit .....	5	<b>Pump Down Operation</b> .....	12
2. Drain work .....	5	<b>Trial Operation and Testing</b> .....	13
3. Flaring the pipe end.....	6	1. Trial operation and testing .....	13
		2. Test items .....	13

The pictures in this document are for illustrative purposes only.

# Safety Considerations

Refer also to the General Safety Considerations in the separate booklet.



**Read the precautions in this manual carefully before operating the unit.**





Read these **Safety Considerations for Installation** carefully before installing an air conditioner or heat pump. After completing the installation, make sure that the unit operates properly during the startup operation.

Instruct the user on how to operate and maintain the unit. Inform users that they should store this installation manual with the operation manual for future reference.

Always use a licensed installer or contractor to install this product. Improper installation can result in water or refrigerant leakage, electric shock, fire, or explosion.

Meanings of **DANGER**, **WARNING**, **CAUTION**, and **NOTE**

Symbols:

-  **DANGER** .....
-  **WARNING** .....
-  **CAUTION** .....
-  **NOTE** .....

**DANGER**

- Refrigerant gas is heavier than air and replaces oxygen. A massive leak can lead to oxygen depletion, especially in basements, and an asphyxiation hazard could occur leading to serious injury or death.
- Do not ground units to water pipes, gas pipes, telephone wires, or lightning rods as incomplete grounding can cause a severe shock hazard resulting in severe injury or death. Additionally, grounding to gas pipes could cause a gas leak and potential explosion causing severe injury or death.

- If refrigerant gas leaks during installation, ventilate the area immediately. Refrigerant gas may produce toxic gas if it comes into contact with fire. Exposure to this gas could cause severe injury or death.
- After completing the installation work, check that the refrigerant gas does not leak throughout the system.
- Do not install unit in an area where flammable materials are present due to risk of explosions that can cause serious injury or death.
- Safely dispose all packing and transportation materials in accordance with federal/state/local laws or ordinances. Packing materials such as nails and other metal or wood parts, including plastic packing materials used for transportation may cause injury or death by suffocation.

 **WARNING**

- Only qualified personnel licensed or certified in their jurisdiction must carry out the installation work. Installation must be done in accordance with this installation manual. Improper installation may result in water leakage, electric shock, or fire.
- When installing the unit in a small room, take measures to keep the refrigerant concentration from exceeding allowable safety limits. Excessive refrigerant leaks, in the event of an accident in a closed ambient space, can lead to oxygen deficiency.
- Use only specified accessories and parts for installation work. Failure to use specified parts may result in water leakage, electric shock, fire, or the unit falling.
- Install the air conditioner or heat pump on a foundation strong enough that it can withstand the weight of the unit. A foundation of insufficient strength may result in the unit falling and causing injury.
- Take into account strong winds, typhoons, or earthquakes when installing. Improper installation may result in the unit falling and causing accidents.
- Make sure that a separate power supply circuit is provided for this unit and that all electrical work is carried out by qualified personnel licensed or certified in their jurisdiction according to local, state, and national regulations. An insufficient power supply capacity or improper electrical construction may lead to electric shock or fire.

- Make sure that all wiring is secured, that specified wires are used, and that no external forces act on the terminal connections or wires. Improper connections or installation may result in fire.
- When wiring, position the wires so that the protection plate can be securely fastened. Improper positioning of the protection plate may result in electric shock, fire, or the terminals overheating.
- Before touching electrical parts, turn off the unit.
- The circuit must be protected with safety devices in accordance with local and national codes, i.e. a circuit breaker.
- Securely fasten the outdoor unit protection plate. If the protection plate is not installed properly, dust or water may enter the outdoor unit causing fire or electric shock.
- When installing or relocating the system, keep the refrigerant circuit free from substances other than the specified refrigerant (R410A) such as air. Any presence of air or other foreign substance in the refrigerant circuit can cause an abnormal pressure rise or rupture, which may result in equipment damage and even injury.
- Do not change the setting of the protection devices. If the pressure switch, thermal switch, or other protection device is shorted and operated forcibly, or parts other than those specified by Daikin are used, fire or explosion may occur.
- Do not use means to accelerate the defrosting process (if possible) or to clean, other than those recommended by the manufacturer.
- The appliance must be stored in a room without continuously operating ignition sources (for example: open flames, an operating gas appliance or an operating electric heater).
- Do not pierce or burn.
- Be aware that refrigerants may not contain an odor.
- Comply with national gas regulations.

**⚠ CAUTION**

- Do not touch the switch with wet fingers. Touching a switch with wet fingers can cause electric shock.
- Do not allow children to play on or around the unit to prevent injury.
- Wear adequate personal protective equipment (protective gloves, safety glasses,...) when installing, maintaining or servicing the system.
- The heat exchanger fins are sharp enough to cut. To avoid injury, wear gloves or cover the fins while working around them.
- Do not touch the refrigerant pipes during and immediately after operation as the refrigerant pipes may be hot or cold, depending on the condition of the refrigerant flowing through the refrigerant piping, compressor, and other refrigerant cycle parts. Your hands may suffer burns or frostbite if you touch the refrigerant pipes. To avoid injury, give the pipes time to return to normal temperature or, if you must touch them, be sure to wear proper gloves.
- Install drain piping to ensure proper drainage. Improper drain piping may result in water leakage and property damage.
- Insulate piping to prevent condensation.
- Be careful when transporting the product.
- Do not turn off the power immediately after stopping operation. Always wait for at least 5 minutes before turning off the power. Otherwise, water leakage may occur.
- Do not use a charging cylinder. Using a charging cylinder may cause the refrigerant to deteriorate.
- Refrigerant R410A in the system must be kept clean, dry, and tight.
  - (a) Clean and Dry -- Foreign materials (including mineral oils such as SUNISO oil or moisture) should be prevented from getting into the system.



- (b) Tight -- R410A does not contain any chlorine, does not destroy the ozone layer, and does not reduce the earth's protection against harmful ultraviolet radiation. R410A can contribute to the greenhouse effect if it is released. Therefore take proper measures to check for the tightness of the refrigerant piping installation. Read the chapter *Refrigerant Piping* and follow the procedures.
- Since R410A is a blend, the required additional refrigerant must be charged in its liquid state. If the refrigerant is charged in a state of gas, its composition can change and the system will not work properly.
- The outdoor unit is for R410A. See the catalog for indoor models that can be connected. Normal operation is not possible when connected to non-compatible indoor units.
- Remote controller (wireless kit) transmitting distance can be shorter than expected in rooms with electronic fluorescent lamps (inverter or rapid start types). Install the indoor unit far away from fluorescent lamps as much as possible.
- Indoor units are for indoor installation only. Outdoor units can be installed either outdoors or indoors.
- Do not install the air conditioner or heat pump in the following locations:
  - (a) Where a mineral oil mist or oil spray or vapor is produced, for example, in a kitchen. Plastic parts may deteriorate and fall off or result in water leakage.
  - (b) Where corrosive gas, such as sulfurous acid gas, is produced. Corroding copper pipes or soldered parts may result in refrigerant leakage.
  - (c) Near machinery emitting electromagnetic waves. Electromagnetic waves may disturb the operation of the control system and cause the unit to malfunction.
  - (d) Where flammable gas may leak, where there is carbon fiber, or ignitable dust suspension in the air, or where volatile flammables such as thinner or gasoline are handled. Operating the unit in such conditions can cause a fire.
- Take adequate measures to prevent the outdoor unit from being used as a shelter by small animals. Small animals making contact with electrical parts can cause malfunctions, smoke, or fire. Instruct the user to keep the area around the unit clean.
- Servicing shall be performed only as recommended by the manufacturer and licensed or certified in their jurisdiction.

**⚠ NOTE**

- The outdoor unit should be positioned where the unit and power supply wires (breaker panel to outdoor unit) are at least 10ft (3m) away from any televisions or radios. (The unit may cause interference with the picture or sound.) Depending on the radio waves, a distance of 10ft (3m) may not be sufficient to eliminate the noise.
- Dismantling the unit, treatment of the refrigerant, oil and additional parts must be done in accordance with the relevant local, state, and national regulations.
- Only use tools for R410A, such as a gauge manifold, charge hose, gas leak detector, reverse flow check valve, refrigerant charge base, vacuum gauge, or refrigerant recovery equipment.
- If the conventional refrigerant and refrigerator oil are mixed in R410A, the refrigerant may deteriorate.
- This air conditioner or heat pump is an appliance that should not be accessible to the general public.
- As maximum allowable pressure is 604psi (4.17MPa), the wall thickness of field-installed pipes should be selected in accordance with the relevant local, state, and national regulations.

RN006-U

# Accessories

<p>(A) Installation manual</p>	<p>1</p>	<p>(B) Drain socket</p>  <p>This is at the bottom of the packaging.</p>	<p>1</p>
<p>(C) Drain cap (1)</p> 	<p>4</p>	<p>(D) Drain cap (2)</p> 	<p>2</p>
<p>(E) Warranty</p>	<p>1</p>	<p>(F) General safety consideration</p>	<p>1</p>

# Precautions for Selecting a Location

- 1) Choose a place solid enough to bear the weight and vibration of the unit, where the operating sound will not be amplified.
- 2) Choose a location where the air discharged from the unit or the operating sound will not cause a nuisance to the neighbors of the user.
- 3) Avoid locations, such as near bedrooms, where the operating sound may cause disturbance.
- 4) There must be sufficient space to carry the unit into and out of the site.
- 5) There must be sufficient space for air passage and no obstructions around the air inlet and the air outlet.
- 6) The site must not be prone to flammable gas leaks in the surrounding area.
- 7) In coastal areas or other places with a salty atmosphere or one containing sulfate gas, corrosion may shorten the life of the air conditioner.
- 8) Since water will flow from the drain of the outdoor unit, do not place anything under the unit which must be kept away from moisture.
- 9) A location where flammable gas does not leak. Position at least 6-5/8ft (2m) from propane gas cylinders.

**NOTE**

Cannot be installed suspended from a ceiling or stacked.

**CAUTION**

When operating the air conditioner in a low outdoor ambient temperature, be sure to follow the instructions described below.

- To prevent exposure to wind, install the outdoor unit with its suction side facing the wall.
- Never install the outdoor unit at a site where the suction side may be exposed directly to wind.
- To prevent exposure to wind, it is recommended to install a baffle plate on the air discharge side of the outdoor unit.
- In heavy snow areas, select an installation site where the snow will not affect the unit.
- If there is a likelihood of snow accumulating on the outdoor unit, attach a snow protection hood.
- In high humidity areas or heavy snow areas, it is recommended to attach a drain pan heater to prevent ice build-up from the bottom frame.

- Construct a large canopy.
- Construct a pedestal.



Install the unit high enough off the ground to prevent burying in snow.

# Precautions on Installation

- Check the strength and level of the installation surface so that the unit does not cause any operating vibrations or noise after installation.
- Fix the unit in place securely using foundation bolts, as in the figure. (Prepare 4 sets of 5/16 inch (M8) or 3/8 inch (M10) foundation bolts, nuts and washers; all sold separately.)
- It is best to screw in the foundation bolts until their ends are 3/4 inch (20mm) from the foundation surface.

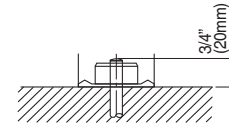

# Outdoor Unit Installation Diagram

Max. allowable piping length	65-5/8ft (20m)
Min. allowable piping length	10ft (3m)
Max. allowable piping height	49-1/4ft (15m)
Additional refrigerant required for refrigerant pipe exceeding 32-3/4ft (10m) in length.	0.21oz/ft (20g/m)
Gas pipe	O.D. 3/8 inch (9.5mm)
Liquid pipe	O.D. 1/4 inch (6.4mm)

Refrigerant piping must be kept to a minimum.  
 \*Be sure to add the proper amount of additional refrigerant.  
 Failure to do so may result in reduced performance.  
 \*\*The suggested shortest pipe length is 10ft (3m), in order to avoid noise from the outdoor unit and vibration.  
 (Mechanical noise and vibration may occur depending on how the unit is installed and the environment in which it is used.)

If strong wind blows into the air discharge side from the front and there is a danger that the fan may be damaged, change the orientation of the air discharge side of the outdoor unit or use an air direction adjustment grille (sold separately).

In sites with poor drainage, use block bases for the outdoor unit. Adjust foot height until the unit is level. Otherwise, water leakage or pooling of water may occur.

Allow 11-13/16 (300) of work space below the ceiling surface.

Refrigerant piping must be protected from physical damage. Install a plastic cover or equivalent.

Wrap the insulation pipe with finishing tape from bottom to top.

**CAUTION**  
 Keep the piping length between 10ft (3m) and 65-5/8ft (20m)

**Stop valve cover**  
**How to remove the stop valve cover**  
 1) Remove the screw on the stop valve cover.  
 2) Slide the stop valve cover downward to remove it.  
**How to attach the stop valve cover**  
 1) Insert the upper part of the stop valve cover into the outdoor unit.  
 2) Tighten the screw.

Allow space for piping and electrical servicing.

If there is a danger of the unit falling or overturning, fix the unit with foundation bolts, or with wire or other means.

unit: inch (mm)

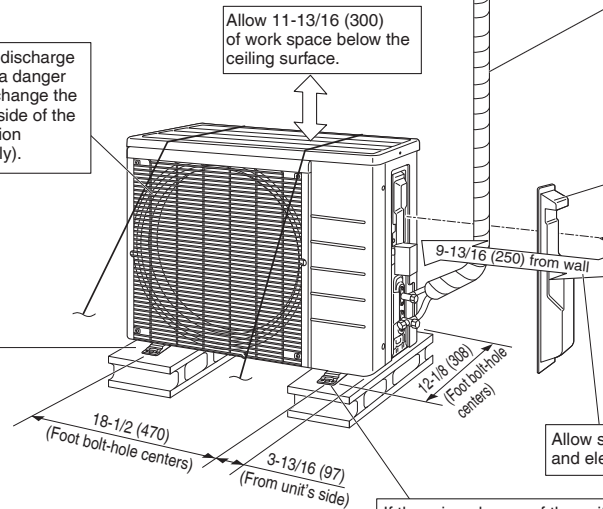

# Installation Space Requirements

- Position the unit on a horizontal surface. Any tilt in the unit should be 3° or less to the horizontal.
- Where a wall or other obstacle is in the path of the outdoor unit's intake or exhaust airflow, follow the installation space requirements below.
- For any of the below installation patterns, the wall height on the outlet side should be 47-1/4 inch (1200mm) or less.
- Secure as much installation space around the unit as the location allows, as more space will result in more efficient operation.

### Wall facing one side

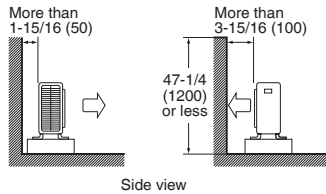

### Walls facing two sides

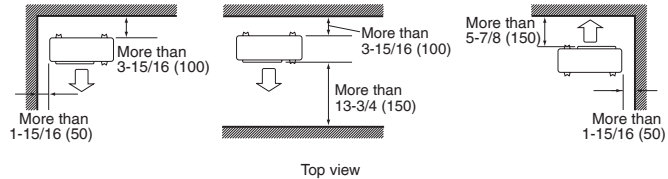

### Walls facing three sides

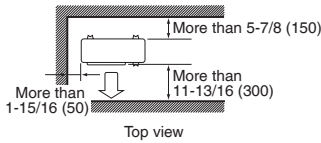

When installed as in the figure on the left, it is recommended to either change the orientation of the outdoor unit outlet side or use the air direction adjustment grille (sold separately).

unit: inch (mm)

# Outdoor Unit Installation

## 1. Installing the outdoor unit

- When installing the outdoor unit, refer to "Precautions for Selecting a Location" on page 3 and the "Outdoor Unit Installation Diagram" on page 4.
- If drain work is necessary, follow the procedures below.

## 2. Drain work

### ⚠ CAUTION

In cold areas, do not use a drain socket, drain caps (1, 2) and a drain hose with the outdoor unit. (Drain water may freeze, impairing heating performance.)

- If the drain port is covered by a mounting base or floor surface, place additional foot bases of at least 1-1/4 inch (30mm) in height under the outdoor unit's feet.
- 1) Attach ① drain cap (1) and ② drain cap (2).
  - 2) Attach ③ drain socket.
    - When attaching ③ drain socket to the bottom frame, make sure to connect the drain hose to the drain socket first.

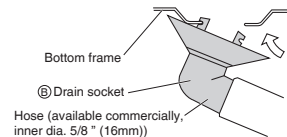
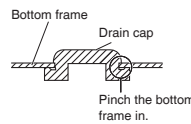
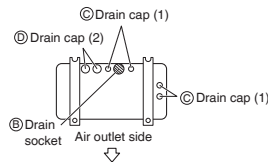



### 3. Flaring the pipe end

**⚠ WARNING**

- Do not apply mineral oil to the flare.
- Prevent mineral oil from getting into the system as this would reduce the service life of the units.
- Never use piping which has been used for previous installations. Only use parts which are delivered with this unit.
- Never install a dryer to this R410A unit in order to guarantee its service life.
- The drying material may dissolve and damage the system.
- Improper flaring may result in refrigerant gas leakage.

**⚠ CAUTION**

Do not reuse joints which have been used once already.

- 1) Cut the pipe end with a pipe cutter.
- 2) Remove burrs with the cut surface facing downward, so that the filings do not enter the pipe.
- 3) Put the flare nut on the pipe.
- 4) Flare the pipe.
- 5) Check that the flaring has been done correctly.

**Flaring**

Set exactly at the position shown below.			
Die	Flare tool for R410A		Conventional flare tool
	Clutch-type	Clutch-type (Rigid-type)	Wing-nut type (Imperial-type)
A	0-0.020 inch (0-0.5mm)	0.039-0.059 inch (1.0-1.5mm)	0.059-0.079 inch (1.5-2.0mm)

### 4. Refrigerant piping

**⚠ CAUTION**

- Use the flare nut fixed to the main unit. (This is to prevent the flare nut from cracking as a result of deterioration over time.)
  - To prevent gas leakage, apply refrigeration oil only to the inner surface of the flare. (Use refrigeration oil for R410A.)
  - Use a torque wrench when tightening the flare nuts to prevent damage to the flare nuts and gas leakage.
- 
- Align the centers of both flares and tighten the flare nuts 3 or 4 turns by hand, then tighten them fully with a spanner and a torque wrench.

**Tightening torque**

Piping connection

Flare nut	
Gas side	Liquid side
3/8 inch (9.5mm)	1/4 inch (6.4mm)
24-1/8 – 29-1/2 lbf • ft (32.7-39.9N • m)	10-1/2 – 12-3/4 lbf • ft (14.2-17.2N • m)

Valve cap

Width across flats	
11/16 inch (17mm)	3/4 inch (19mm)
10-1/2 – 12-5/8 lbf • ft (14.2-17.2N • m)	12-5/8 – 15-3/8 lbf • ft (17.0-21.0N • m)

Service port cap

8 – 10-7/8 lbf • ft (10.7-14.7N • m)
---

# Outdoor Unit Installation

## Cautions on pipe handling

- Protect the open end of the pipe from dust and moisture.
- All pipe bends should be as gentle as possible. Use a pipe bender for bending.

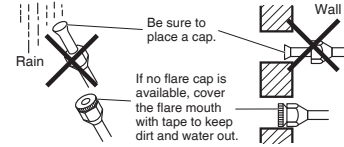

## Selection of copper and heat insulation materials

When using commercial copper pipes and fittings, observe the following:

- Insulation material: Polyethylene foam  
Heat transfer rate: 0.041 to 0.052W/mK (0.024 to 0.030Btu/ft<sup>h</sup>°F) (0.035 to 0.045kcal/mh°C)  
Be sure to use insulation that is designed for use with HVAC Systems.
- ACR Copper only.
- Be sure to insulate both the gas and liquid piping and observe the insulation dimensions as below.

	Piping size	Minimum bend radius	Piping thickness	Thermal insulation size	Thermal insulation thickness
Gas side	O.D. 3/8 inch (9.5mm)	1-3/16 inch (30mm) or more	0.031 inch (0.8mm) (C1220T-O)	I.D. 15/32-19/32 inch (12-15mm)	13/32 inch (10mm) Min.
Liquid side	O.D. 1/4 inch (6.4mm)	1-3/16 inch (30mm) or more	0.031 inch (0.8mm) (C1220T-O)	I.D. 5/16-13/32 inch (8-10mm)	

- Use separate thermal insulation pipes for gas and liquid refrigerant pipes.
- Using finishing tape, bundle and wrap the indoor unit piping and drain hose together so that the drain hose is below the other piping.

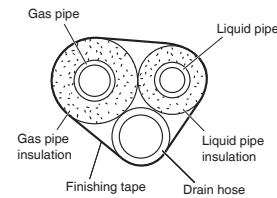

## 5. Pressure test and evacuating system

### ⚠ WARNING

- Make sure that air or any matter other than refrigerant (R410A) does not get into the refrigeration cycle.
- If refrigerant gas leaks should occur, ventilate the room as soon and as much as possible.
- R410A, as well as other refrigerants, should always be recovered and never be released directly into the environment.
- Use a vacuum pump for R410A exclusively. Using the same vacuum pump for different refrigerants may damage the vacuum pump or the unit.

### ⚠ CAUTION

It is highly recommended that you do not open/close the stop valves when the outdoor temperature is below -5°F (-21°C) as this may result in refrigerant leakage.

- When piping work is complete, it is necessary to perform a pressure test and evacuate system with a vacuum pump.
- If using additional refrigerant, purge the air from the refrigerant pipes and indoor unit using a vacuum pump, then charge additional refrigerant.
- Use a hexagonal wrench (3/16 inch (4mm)) to operate the stop valve rod.
- All refrigerant pipe joints should be tightened with a torque wrench to the specified tightening torque.

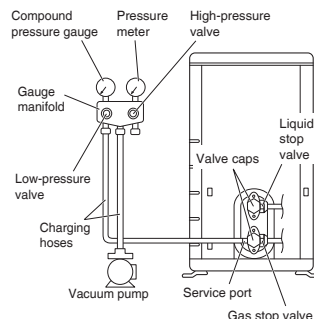

- 1) Pressurize the liquid pipe and gas pipe from the service ports of each stop valve to 604psi (4.17MPa) (do not pressurize more than 604psi (4.17MPa)) for 1 hour minimum, 24 hours recommended. If there is a pressure drop, check for leaks, make repairs and perform the pressure test again.
- 2) Connect the gauge manifold's charging hose to the gas stop valve's service port.
- 3) Fully open the low-pressure valve (Lo) on the gauge manifold and fully close the high-pressure valve (Hi). (High-pressure valve will require no further operation.)
- 4) Evacuate system using vacuum pump to below 500 microns for 1 hour minimum.
- 5) Close the low-pressure valve (Lo) on the gauge manifold and stop vacuum pumping. (Maintain this condition for a few minutes to make sure that the compound pressure gauge pointer does not swing back.)\*1
- 6) Remove the valve caps from the liquid stop valve and gas stop valve.
- 7) To open the liquid stop valve, turn the rod of the valve 90° counter-clockwise using a hexagonal wrench. Close it after 5 seconds, and check for gas leakage. Using soapy water, check for gas leakage from the indoor unit's flare and outdoor unit's flare and valve rods. After the check is complete, wipe all soapy water off.
- 8) Disconnect the charging hoses from the service port for the gas stop valve, then fully open the liquid and gas stop valves. (Do not attempt to turn the valve rods further than they can go.)
- 9) Tighten the valve caps and service port caps for the liquid and gas stop valves with a torque wrench to the specified torques. Refer to "4. Refrigerant piping" on page 6 for details.

\*1 If the compound pressure gauge pointer swings back, the refrigerant may have water content or there may be a loose pipe joint. Check all pipe joints and retighten nuts as needed, then repeat steps 3) through 5).

## 6. Refilling refrigerant

Check the type of refrigerant to be used on the machine nameplate.

### Precautions when adding R410A

#### Fill from the liquid pipe in liquid form.

R410A is a mixed refrigerant, so adding it in gas form may cause the refrigerant composition to change, preventing normal operation.

- Before filling, check whether the cylinder has a siphon attached or not. (It should have something like "liquid filling siphon attached" displayed on it.)

Filling a cylinder with an attached siphon



Stand the cylinder upright when filling.

(There is a siphon pipe inside, so the cylinder need not be upside-down to fill with liquid.)

Filling other cylinders



Turn the cylinder upside-down when filling.

- Be sure to use the R410A tools to ensure pressure and to prevent foreign objects from entering.

# Wiring

## ⚠ WARNING

- Do not ground units to water pipes, gas pipes, telephone wires, or lightning rods as incomplete grounding can cause a severe shock hazard resulting in severe injury or death. Additionally, grounding to gas pipes could cause a gas leak and potential explosion causing severe injury or death.
- Do not use tapped wires, extension cords, or starburst connections, as they may cause overheating, electric shock, or fire.
- Do not use locally purchased electrical parts inside the product. (Do not branch the power for the drain pump, etc., from the terminal block.) Doing so may cause electric shock or fire.
- The circuit must be protected with safety devices in accordance with local and national codes, i.e. a circuit breaker.
- Use an all-pole disconnection type circuit breaker with at least 1/8 inch (3mm) between the contact point gaps.
- When carrying out wiring, take care not to pull at the conduit.
- Do not connect the power wire to the indoor unit. Doing so may cause electric shock or fire.
- Do not turn on the circuit breaker until all work is completed.

## ⚠ CAUTION

### Precautions to be taken for power supply wiring

Recommend stranded cable for interunit wiring. Local code always supersedes recommendation.

- For stranded wires, make sure to use the round crimp-style terminal for connection to the power supply terminal block. Place the round crimp-style terminals on the wires up to the covered part and secure in place.

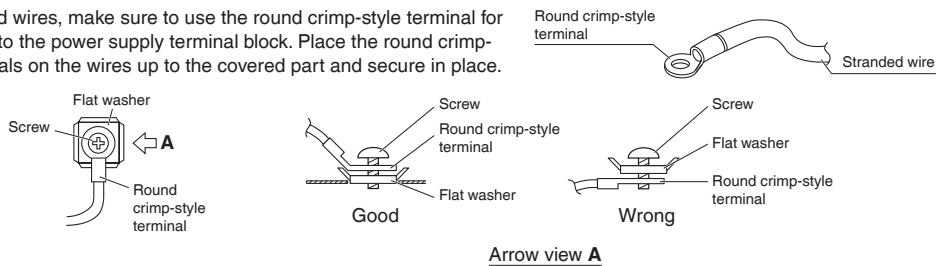

- If solid core wire must be used, be sure to curl the end of the lead. Improper work may cause heat and fire.

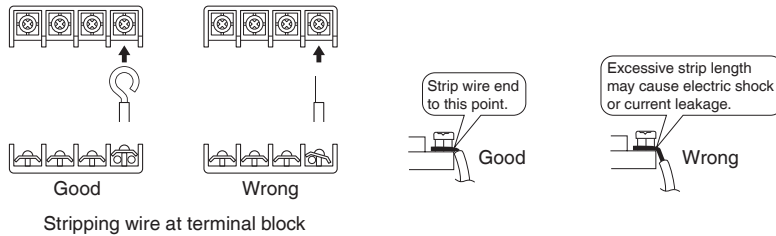

- 1) Strip the insulation from the wire (3/4 inch (20mm)).
- 2) Connect the inter-unit wires between the indoor and outdoor units so that the terminal numbers match. Tighten the terminal screws securely. It is recommended that a slot-head screwdriver be used to tighten the screws.

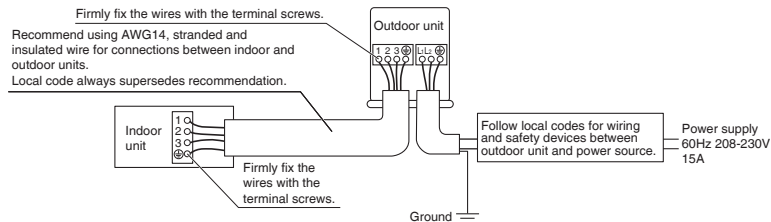

### NOTE

Take care to ensure that all wiring between indoor unit and outdoor unit has a consistent connection. Any splices can cause communication errors.

[Method of mounting conduit]

- A protection plate is fixed for protection from the high-voltage section.
- 1) Dismount the stop valve cover by removing the screw.
- 2) Dismount the protection plate by removing the 2 screws.
- 3) Dismount the conduit mounting cover by removing the 2 screws.
- 4) Pass wires through the conduit and secure them with a lock nut.
- 5) After completing the work, reattach the conduit mounting cover, the protection plate, and the stop valve cover to its original position.

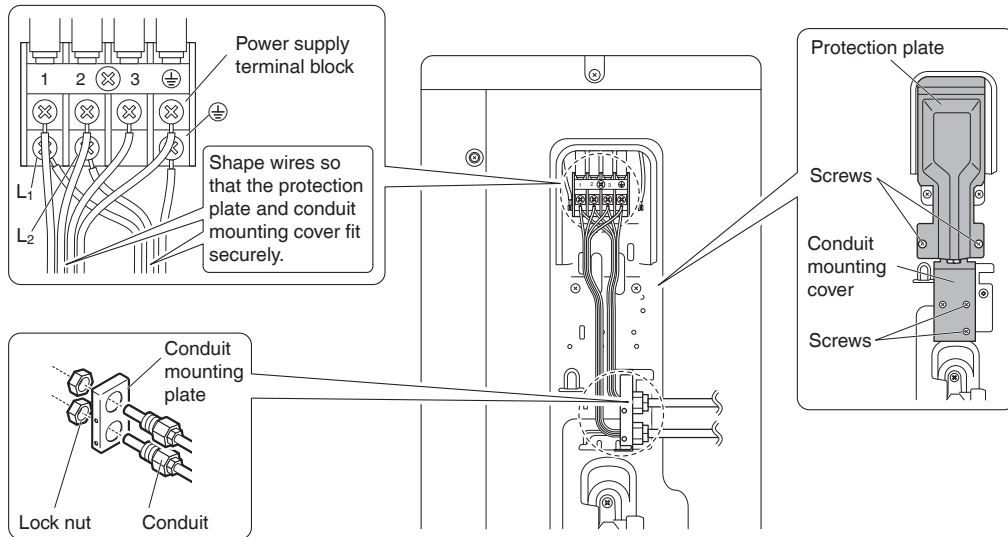

**Ground**

This air conditioner must be grounded. For grounding, follow all local, and state electrical codes.

# Facility Setting (cooling at low outdoor temperature)

**⚠ WARNING** \_\_\_\_\_  
Make sure to turn the power OFF before performing work.

- ⚠ CAUTION** \_\_\_\_\_
- If the outdoor unit is installed where the heat exchanger of the unit is exposed to direct wind, provide a windbreak wall.
  - Intermittent noises may be produced by the indoor unit due to the outdoor fan turning on and off when using facility settings.
  - Do not place humidifiers or other items which might raise the humidity in rooms where facility settings are being used. A humidifier might cause dew condensation from the indoor unit outlet vent.
  - Cutting the jumper 6 (J6) sets the indoor fan tap to the highest position. Notify the user about this.

# Facility Setting (cooling at low outdoor temperature)

This function is designed for facilities such as equipment or computer rooms. It is never to be used in a residence or office where people occupy the space.

- Cutting the jumper 6 (J6) on the circuit board will expand the operation range down to 14°F (-10°C).  
Installing an air direction adjustment grille (sold separately) will further extend the operation range to -4°F (-20°C). In these cases, the unit will stop operating if the outdoor temperature falls below -4°F (-20°C), restarting once the temperature rises above this level.

- 1) Remove the top plate of the outdoor unit. (4 screws)
- 2) Remove the front plate. (5 screws)
- 3) Cut the jumper (J6) of the PCB inside.

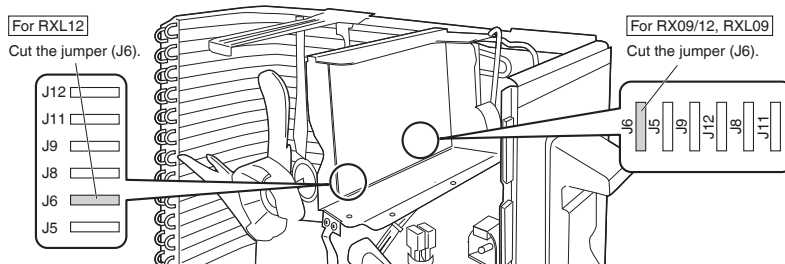

# When Attaching the Drain Pan Heater

**⚠ WARNING**

- Make sure to turn the power OFF before performing work.

In high humidity areas or heavy snow areas, it is recommended to attach a drain pan heater to prevent ice build-up from the bottom frame.

- 1) Attach the drain pan heater in accordance with the installation manual included with the drain pan heater.
- 2) Cut the jumper (J9) of the PCB inside.

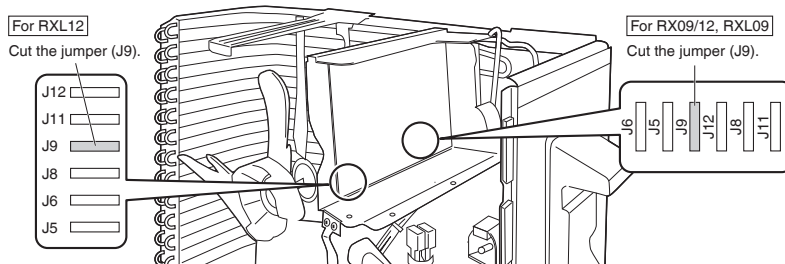

# Pump Down Operation

**In order to protect the environment, be sure to pump down when relocating or disposing of the unit.**

- 1) Remove the valve caps from the liquid stop valve and gas stop valve.
- 2) Begin forced cooling operation.
- 3) After 5 to 10 minutes, close the liquid stop valve with a hexagonal wrench.
- 4) After 2 to 3 minutes, close the gas stop valve and stop forced cooling operation.
- 5) Attach the valve caps once procedures are complete.

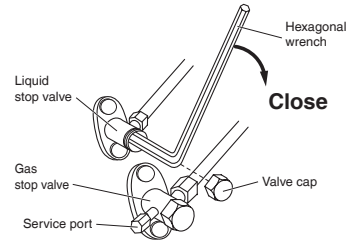

## Forced cooling operation

### ■Using the indoor unit ON/OFF switch

[For FTX, FTXR and FVX models]

Press the indoor unit ON/OFF switch for at least 5 seconds. (The operation will start.)

- Forced cooling operation will stop automatically after about 15 minutes. To stop the operation, press the indoor unit ON/OFF switch.

### ■Using the indoor unit's remote controller

[For FTX models]

- 1) Press , and at the same time.
- 2) Press , then select , press .
- 3) Press to turn on the system.

- Forced cooling operation will stop automatically after about 30 minutes. To stop the operation, press .

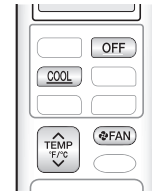

[For FTXR and FVX models]

- 1) Press , and at the same time.
- 2) Press , select " 7- " , and press for confirmation.
- 3) Press and select the COOL operation.
- 4) Press to turn on the system.

- Forced cooling operation will stop automatically after about 30 minutes. To stop the operation, press .



[For FFQ and FDMQ models]



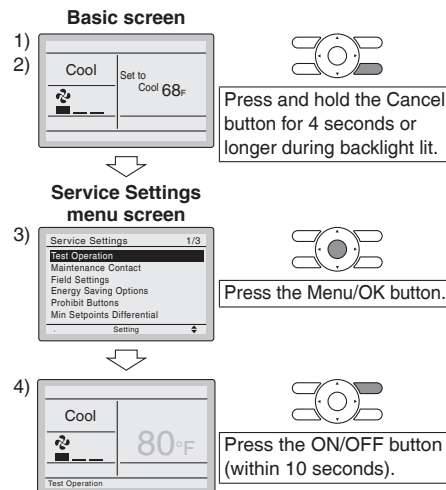

[For wired remote controller]

- 1) Set to COOL operation using the remote controller.
- 2) Press and hold the Cancel button for 4 seconds or longer. Service settings menu is displayed.
- 3) Select **Test Operation** in the service settings menu, and press the Menu/OK button. Basic screen returns and "Test Operation" is displayed at the bottom.
- 4) Press the ON/OFF button within 10 seconds, and the forced cooling operation starts.
  - Forced cooling operation will stop automatically after about 15 minutes. To stop the operation, press the ON/OFF button.



# Pump Down Operation

[For wireless remote controller]

- 1) Press  and select the COOL operation.
  - 2) Press  twice. "Test" is displayed.
  - 3) Press  within 10 seconds, and the forced cooling operation starts.
- Forced cooling operation will stop automatically after about 15 minutes.
- To stop the operation, press .

# Trial Operation and Testing

## 1. Trial operation and testing

Refer to the installation manual for the indoor unit.

## 2. Test items

Test items	Symptom	Check
Indoor and outdoor units are installed securely.	Fall, vibration, noise	
No refrigerant gas leaks.	Incomplete cooling/heating function	
Refrigerant gas and liquid pipes and indoor drain hose extension are thermally insulated.	Water leakage	
Draining line is properly installed.	Water leakage	
System is properly grounded.	Electrical leakage	
Only specified wires are used for all wiring, and all wires are connected correctly.	No operation or burn damage	
Indoor or outdoor unit's air inlet or air outlet are unobstructed.	Incomplete cooling/heating function	
Stop valves are opened.	Incomplete cooling/heating function	
<b>[For FFQ models]</b> Check that the connector of the lead wires of the decoration panel is connected securely.	Louvers do not move	
Indoor unit properly receives remote control commands.	No operation	



## 12.6 RXL15/18/24

# Contents

<b>Safety Considerations</b> .....	1	4. Refrigerant piping .....	6
<b>Accessories</b> .....	3	5. Pressure test and evacuating system.....	7
<b>Precautions for Selecting a Location</b> .....	3	6. Refilling refrigerant .....	8
<b>Precautions on Installation</b> .....	4	<b>Wiring</b> .....	9
<b>Outdoor Unit Installation Diagram</b> .....	4	<b>Facility Setting</b>	
<b>Installation Space Requirements</b> .....	5	<b>(cooling at low outdoor temperature)</b> .....	11
<b>Outdoor Unit Installation</b> .....	5	<b>When attaching the drain pan heater</b> .....	12
1. Installing the outdoor unit .....	5	<b>Pump Down Operation</b> .....	13
2. Drain work (Only for heat pump models).....	5	<b>Trial Operation and Testing</b> .....	14
3. Flaring the pipe end.....	6	1. Trial operation and testing .....	14
		2. Test items .....	14

The pictures in this document are for illustrative purposes only.

# Safety Considerations

Refer also to the General Safety Considerations in the separate booklet.







**Read the precautions in this manual carefully before operating the unit.**

Read these **Safety Considerations for Installation** carefully before installing an air conditioner or heat pump. After completing the installation, make sure that the unit operates properly during the startup operation.

Instruct the user on how to operate and maintain the unit. Inform users that they should store this installation manual with the operation manual for future reference. Always use a licensed installer or contractor to install this product. Improper installation can result in water or refrigerant leakage, electric shock, fire, or explosion.

Meanings of **DANGER**, **WARNING**, **CAUTION**, and **NOTE** Symbols:

-  **DANGER** .....
-  **WARNING** .....
-  **CAUTION** .....
-  **NOTE** .....

-  **DANGER** .....
- Refrigerant gas is heavier than air and replaces oxygen. A massive leak can lead to oxygen depletion, especially in basements, and an asphyxiation hazard could occur leading to serious injury or death.
- Do not ground units to water pipes, gas pipes, telephone wires, or lightning rods as incomplete grounding can cause a severe shock hazard resulting in severe injury or death. Additionally, grounding to gas pipes could cause a gas leak and potential explosion causing severe injury or death.

- If refrigerant gas leaks during installation, ventilate the area immediately. Refrigerant gas may produce toxic gas if it comes into contact with fire. Exposure to this gas could cause severe injury or death.
- After completing the installation work, check that the refrigerant gas does not leak throughout the system.
- Do not install unit in an area where flammable materials are present due to risk of explosions that can cause serious injury or death.
- Safely dispose all packing and transportation materials in accordance with federal/state/local laws or ordinances. Packing materials such as nails and other metal or wood parts, including plastic packing materials used for transportation may cause injury or death by suffocation.

 **WARNING** .....

- Only qualified personnel licensed or certified in their jurisdiction must carry out the installation work. Installation must be done in accordance with this installation manual. Improper installation may result in water leakage, electric shock, or fire.
- When installing the unit in a small room, take measures to keep the refrigerant concentration from exceeding allowable safety limits. Excessive refrigerant leaks, in the event of an accident in a closed ambient space, can lead to oxygen deficiency.
- Use only specified accessories and parts for installation work. Failure to use specified parts may result in water leakage, electric shock, fire, or the unit falling.
- Install the air conditioner or heat pump on a foundation strong enough that it can withstand the weight of the unit. A foundation of insufficient strength may result in the unit falling and causing injury.
- Take into account strong winds, typhoons, or earthquakes when installing. Improper installation may result in the unit falling and causing accidents.
- Make sure that a separate power supply circuit is provided for this unit and that all electrical work is carried out by qualified personnel licensed or certified in their jurisdiction according to local, state, and national regulations. An insufficient power supply capacity or improper electrical construction may lead to electric shock or fire.

- Make sure that all wiring is secured, that specified wires are used, and that no external forces act on the terminal connections or wires. Improper connections or installation may result in fire.
- When wiring, position the wires so that the service lid can be securely fastened. Improper positioning of the service lid may result in electric shock, fire, or the terminals overheating.
- Before touching electrical parts, turn off the unit.
- The circuit must be protected with safety devices in accordance with local and national codes, i.e. a circuit breaker.
- Securely fasten the outdoor unit service lid. If the service lid is not installed properly, dust or water may enter the outdoor unit causing fire or electric shock.
- When installing or relocating the system, keep the refrigerant circuit free from substances other than the specified refrigerant (R410A) such as air. Any presence of air or other foreign substance in the refrigerant circuit can cause an abnormal pressure rise or rupture, which may result in equipment damage and even injury.
- Do not change the setting of the protection devices. If the pressure switch, thermal switch, or other protection device is shorted and operated forcibly, or parts other than those specified by Daikin are used, fire or explosion may occur.
- Do not use means to accelerate the defrosting process (if possible) or to clean, other than those recommended by the manufacturer.
- The appliance must be stored in a room without continuously operating ignition sources (for example: open flames, an operating gas appliance or an operating electric heater).
- Do not pierce or burn.
- Be aware that refrigerants may not contain an odor.
- Comply with national gas regulations.

**⚠ CAUTION**

- Do not touch the switch with wet fingers. Touching a switch with wet fingers can cause electric shock.
- Do not allow children to play on or around the unit to prevent injury.
- Wear adequate personal protective equipment (protective gloves, safety glasses,...) when installing, maintaining or servicing the system.
- The heat exchanger fins are sharp enough to cut. To avoid injury, wear gloves or cover the fins while working around them.
- Do not touch the refrigerant pipes during and immediately after operation as the refrigerant pipes may be hot or cold, depending on the condition of the refrigerant flowing through the refrigerant piping, compressor, and other refrigerant cycle parts. Your hands may suffer burns or frostbite if you touch the refrigerant pipes. To avoid injury, give the pipes time to return to normal temperature or, if you must touch them, be sure to wear proper gloves.
- Install drain piping to ensure proper drainage. Improper drain piping may result in water leakage and property damage.
- Insulate piping to prevent condensation.
- Be careful when transporting the product.
- Do not turn off the power immediately after stopping operation. Always wait for at least 5 minutes before turning off the power. Otherwise, water leakage may occur.
- Do not use a charging cylinder. Using a charging cylinder may cause the refrigerant to deteriorate.
- Refrigerant R410A in the system must be kept clean, dry, and tight.
  - (a) Clean and Dry -- Foreign materials (including mineral oils such as SUNISO oil or moisture) should be prevented from getting into the system.



- (b) Tight -- R410A does not contain any chlorine, does not destroy the ozone layer, and does not reduce the earth's protection against harmful ultraviolet radiation. R410A can contribute to the greenhouse effect if it is released. Therefore take proper measures to check for the tightness of the refrigerant piping installation. Read the chapter *Refrigerant Piping* and follow the procedures.
- Since R410A is a blend, the required additional refrigerant must be charged in its liquid state. If the refrigerant is charged in a state of gas, its composition can change and the system will not work properly.
- The outdoor unit is for R410A. See the catalog for indoor models that can be connected. Normal operation is not possible when connected to non-compatible indoor units.
- Remote controller (wireless kit) transmitting distance can be shorter than expected in rooms with electronic fluorescent lamps (inverter or rapid start types). Install the indoor unit far away from fluorescent lamps as much as possible.
- Indoor units are for indoor installation only. Outdoor units can be installed either outdoors or indoors.
- Do not install the air conditioner or heat pump in the following locations:
  - (a) Where a mineral oil mist or oil spray or vapor is produced, for example, in a kitchen. Plastic parts may deteriorate and fall off or result in water leakage.
  - (b) Where corrosive gas, such as sulfurous acid gas, is produced. Corroding copper pipes or soldered parts may result in refrigerant leakage.
  - (c) Near machinery emitting electromagnetic waves. Electromagnetic waves may disturb the operation of the control system and cause the unit to malfunction.
  - (d) Where flammable gas may leak, where there is carbon fiber, or ignitable dust suspension in the air, or where volatile flammables such as thinner or gasoline are handled. Operating the unit in such conditions can cause a fire.
- Take adequate measures to prevent the outdoor unit from being used as a shelter by small animals. Small animals making contact with electrical parts can cause malfunctions, smoke, or fire. Instruct the user to keep the area around the unit clean.
- Servicing shall be performed only as recommended by the manufacturer and licensed or certified in their jurisdiction.

**⚠ NOTE**

- The outdoor unit should be positioned where the unit and power supply wires (breaker panel to outdoor unit) are at least 10ft (3m) away from any televisions or radios. (The unit may cause interference with the picture or sound.) Depending on the radio waves, a distance of 10ft (3m) may not be sufficient to eliminate the noise.
- Dismantling the unit, treatment of the refrigerant, oil and additional parts must be done in accordance with the relevant local, state, and national regulations.
- Only use tools for R410A, such as a gauge manifold, charge hose, gas leak detector, reverse flow check valve, refrigerant charge base, vacuum gauge, or refrigerant recovery equipment.
- If the conventional refrigerant and refrigerator oil are mixed in R410A, the refrigerant may deteriorate.
- This air conditioner or heat pump is an appliance that should not be accessible to the general public.
- As maximum allowable pressure is 604psi (4.17MPa), the wall thickness of field-installed pipes should be selected in accordance with the relevant local, state, and national regulations.

RN006-U

# Accessories

<p>(A) Installation manual</p>	<p>1</p>	<p>(B) Drain socket*</p>  <p>This is at the bottom of the packaging.</p>	<p>1</p>
<p>(C) Drain cap (1)*</p> 	<p>6</p>	<p>(D) Drain cap (2)*</p> 	<p>3</p>
<p>(E) Warranty</p>	<p>1</p>	<p>(F) General safety consideration</p>	<p>1</p>

\* Only for Heat pump models

# Precautions for Selecting a Location

- 1) Choose a place solid enough to bear the weight and vibration of the unit, where the operating sound will not be amplified.
- 2) Choose a location where the air discharged from the unit or the operating sound will not cause a nuisance to the neighbors of the user.
- 3) Avoid locations, such as near bedrooms, where the operating sound may cause disturbance.
- 4) There must be sufficient space to carry the unit into and out of the site.
- 5) There must be sufficient space for air passage and no obstructions around the air inlet and the air outlet.
- 6) The site must not be prone to flammable gas leaks in the surrounding area.
- 7) In coastal areas or other places with a salty atmosphere or one containing sulfate gas, corrosion may shorten the life of the air conditioner.
- 8) Since water will flow from the drain of the outdoor unit, do not place anything under the unit which must be kept away from moisture.
- 9) A location where flammable gas does not leak. Position at least 6-5/8ft (2m) from propane gas cylinders.

**NOTE**

Cannot be installed suspended from a ceiling or stacked.

**⚠ CAUTION**

When operating the air conditioner in a low outdoor ambient temperature, be sure to follow the instructions described below.

- To prevent exposure to wind, install the outdoor unit with its suction side facing the wall.
- Never install the outdoor unit at a site where the suction side may be exposed directly to wind.
- To prevent exposure to wind, it is recommended to install a baffle plate on the air discharge side of the outdoor unit.
- In heavy snow areas, select an installation site where the snow will not affect the unit.
- If there is a likelihood of snow accumulating on the outdoor unit, attach a snow protection hood.
- In high humidity areas or heavy snow areas, it is recommended to attach a drain pan heater to prevent ice build-up from the bottom frame.

- Construct a large canopy.
- Construct a pedestal.



Install the unit high enough off the ground to prevent burying in snow.

# Precautions on Installation

- Check the strength and level of the installation surface so that the unit does not cause any operating vibrations or noise after installation.
- Fix the unit in place securely using foundation bolts, as in the figure. (Prepare 4 sets of 5/16 inch (M8) or 3/8 inch (M10) foundation bolts, nuts and washers; all sold separately.)
- It is best to screw in the foundation bolts until their ends are 3/4 inch (20mm) from the foundation surface.

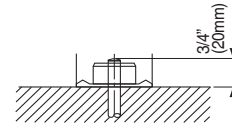

# Outdoor Unit Installation Diagram

	RX15/18 RXL15	RXL18	RX24	RX30/36, RK30/36 RXL24
Max. allowable piping length	98-1/2ft (30m)			
Min. allowable piping length	10ft (3m)			
Max. allowable piping height	65-5/8ft (20m)			
Additional refrigerant required for refrigerant pipe exceeding 32-3/4ft (10m) in length.	0.21oz/ft (20g/m)	0.32oz/ft (30g/m)	0.21oz/ft (20g/m)	0.32oz/ft (30g/m)
Gas pipe	O.D. 1/2 inch (12.7mm)		O.D. 5/8 inch (15.9mm)	
Liquid pipe	O.D. 1/4 inch (6.4mm)			

Refrigerant piping must be kept to a minimum.  
 \*Be sure to add the proper amount of additional refrigerant. Failure to do so may result in reduced performance.  
 \*\*The suggested shortest pipe length is 10ft (3m), in order to avoid noise from the outdoor unit and vibration.  
 (Mechanical noise and vibration may occur depending on how the unit is installed and the environment in which it is used.)

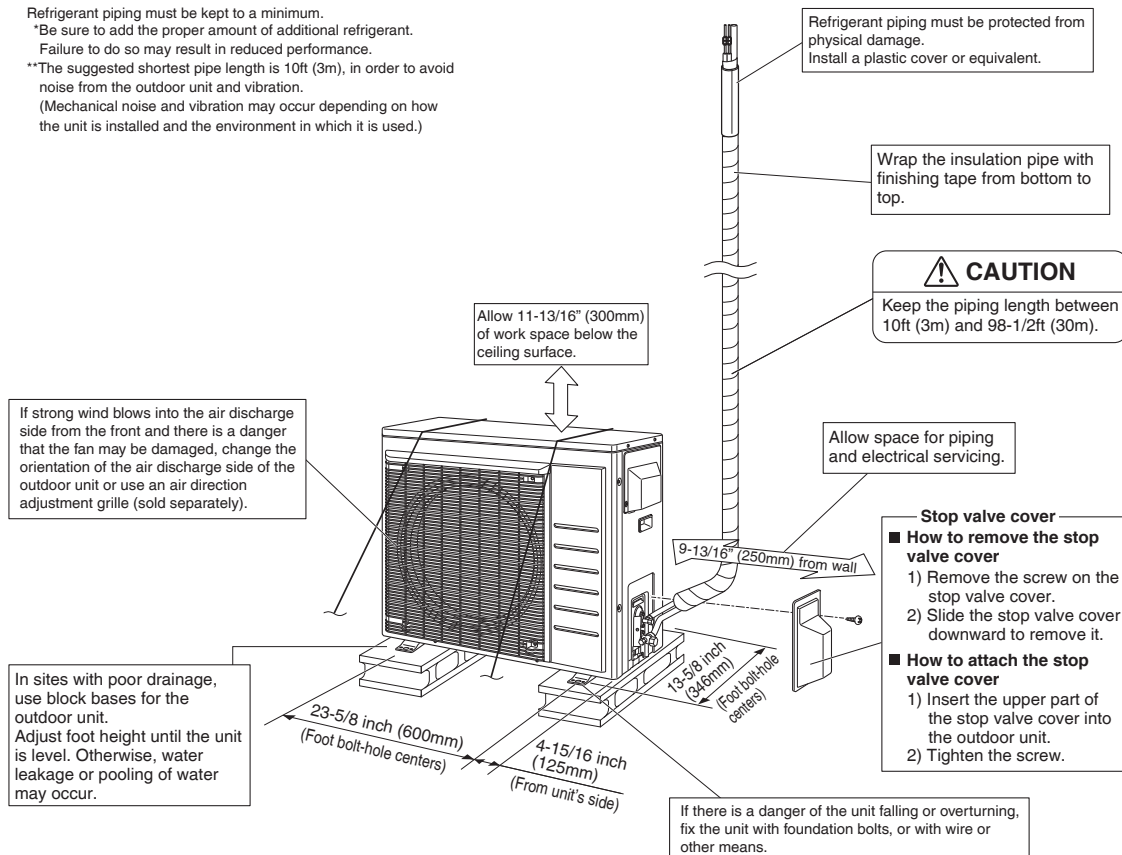

# Installation Space Requirements

- Position the unit on a horizontal surface. Any tilt in the unit should be 3° or less to the horizontal.
- Where a wall or other obstacle is in the path of the outdoor unit's intake or exhaust airflow, follow the installation space requirements below.
- For any of the below installation patterns, the wall height on the outlet side should be 47-1/4 inch (1200mm) or less.
- Secure as much installation space around the unit as the location allows, as more space will result in more efficient operation.

Wall facing one side

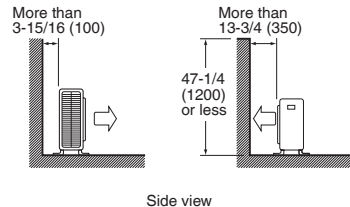

Walls facing two sides

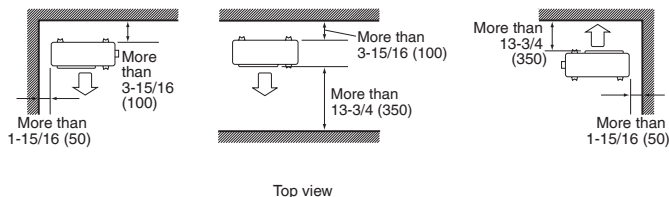

Walls facing three sides

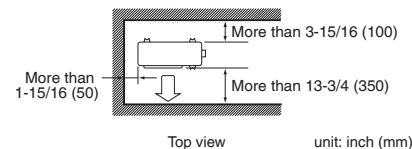

When installed as in the figure on the left, it is recommended to either change the orientation of the outdoor unit outlet side or use the air direction adjustment grille (sold separately).

## Outdoor Unit Installation

### 1. Installing the outdoor unit

- When installing the outdoor unit, refer to "Precautions for Selecting a Location" on page 3 and the "Outdoor Unit Installation Diagram" on page 4.
- If drain work is necessary, follow the procedures below.

### 2. Drain work (Only for heat pump models)

#### ⚠ CAUTION

- In cold areas, do not use a drain socket, drain caps (1,2) and a drain hose with the outdoor unit. (Drain water may freeze, impairing heating performance.)

- If the drain port is covered by a mounting base or floor surface, place additional foot bases of at least 1-1/4 inch (30mm) in height under the outdoor unit's feet.
- 1) Attach ① drain cap (1) and ② drain cap (2).
  - 2) Attach ③ drain socket.
- When attaching ③ drain socket to the bottom frame, make sure to connect the drain hose to the drain socket first.

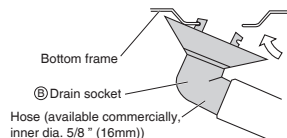
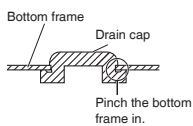
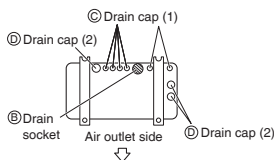

### 3. Flaring the pipe end

#### ⚠ WARNING

- Do not apply mineral oil to the flare.
- Prevent mineral oil from getting into the system as this would reduce the service life of the units.
- Never use piping which has been used for previous installations. Only use parts which are delivered with this unit.
- Never install a dryer to this R410A unit in order to guarantee its service life.
- The drying material may dissolve and damage the system.
- Incomplete flaring may result in refrigerant gas leakage.

#### ⚠ CAUTION

- Do not reuse joints which have been used once already.

- 1) Cut the pipe end with a pipe cutter.
- 2) Remove burrs with the cut surface facing downward, so that the filings do not enter the pipe.
- 3) Put the flare nut on the pipe.
- 4) Flare the pipe.
- 5) Check that the flaring has been done correctly.

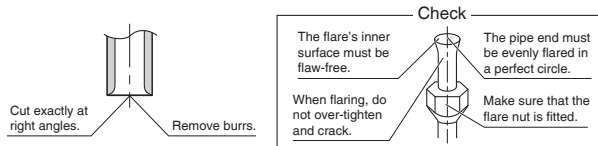

Set exactly at the position shown below.

A	Flare tool for R410A		Conventional flare tool	
	Clutch-type	Clutch-type (Rigid-type)	Wing-nut type (Imperial-type)	
A	0-0.020 inch (0-0.5mm)	0.039-0.059 inch (1.0-1.5mm)	0.059-0.079 inch (1.5-2.0mm)	

### 4. Refrigerant piping

#### ⚠ CAUTION

- Use the flare nut fixed to the main unit. (This is to prevent the flare nut from cracking as a result of deterioration over time.)
  - To prevent gas leakage, apply refrigeration oil only to the inner surface of the flare. (Use refrigeration oil for R410A.)
  - Use a torque wrench when tightening the flare nuts to prevent damage to the flare nuts and gas leakage.
- 1) Align the centers of both flares and tighten the flare nuts 3 or 4 turns by hand, then tighten them fully with a spanner and a torque wrench.

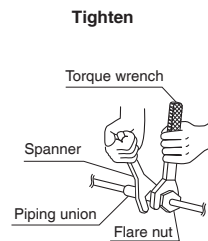
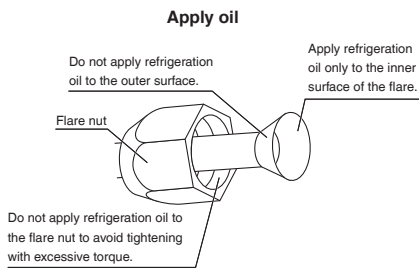

#### Tightening torque

Piping connection

Flare nut		
Gas side		Liquid side
1/2 inch (12.7mm)	5/8 inch (15.9mm)	1/4 inch (6.4mm)
36-1/2-44-1/2lbf • ft (49.5-60.3N • m)	45-5/8-55-5/8lbf • ft (61.8-75.4N • m)	10-1/2-12-3/4lbf • ft (14.2-17.2N • m)

Valve cap

Width across flats		
11/16 inch (17mm)	1-1/16 inch (27mm)	1-3/16 inch (30mm)
10-1/2-12-5/8lbf • ft (14.2-17.2N • m)	35-3/8-44-1/8lbf • ft (48.0-59.8N • m)	16-5/8-20-1/4lbf • ft (22.5-27.5N • m)

Service port cap

8-10-7/8lbf • ft (10.7-14.7N • m)
--------------------------------------

# Outdoor Unit Installation

### Cautions on pipe handling

- Protect the open end of the pipe from dust and moisture.
- All pipe bends should be as gentle as possible. Use a pipe bender for bending.

### Selection of copper and heat insulation materials

When using commercial copper pipes and fittings, observe the following:

- Insulation material: Polyethylene foam  
Heat transfer rate: 0.041 to 0.052W/mK (0.024 to 0.030Btu/ftth°F) (0.035 to 0.045kcal/mh°C)  
Be sure to use insulation that is designed for use with HVAC Systems.
- ACR Copper only.
- Be sure to insulate both the gas and liquid piping and observe the insulation dimensions as below.

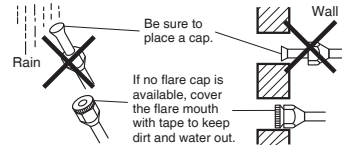

	Piping size	Minimum bend radius	Piping thickness	Thermal insulation size	Thermal insulation thickness
Gas side	O.D. 1/2 inch (12.7mm)	1-9/16 inch (40mm) or more	0.031 inch (0.8mm) (C1220T-O)	I.D. 9/16-5/8 inch (14-16mm)	13/32 inch (10mm) Min.
	O.D. 5/8 inch (15.9mm)	1-15/16 inch (50mm) or more	0.039 inch (1.0mm) (C1220T-O)	I.D. 5/8-13/16 inch (16-20mm)	
Liquid side	O.D. 1/4 inch (6.4mm)	1-3/16 inch (30mm) or more	0.031 inch (0.8mm) (C1220T-O)	I.D. 5/16-13/32 inch (8-10mm)	

- Use separate thermal insulation pipes for gas and liquid refrigerant pipes.
- Using finishing tape, bundle and wrap the indoor unit piping and drain hose together so that the drain hose is below the other piping.

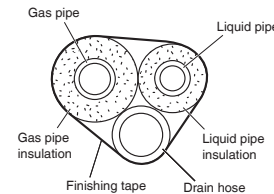

## 5. Pressure test and evacuating system

### ⚠ WARNING

- Make sure that air or any matter other than refrigerant (R410A) does not get into the refrigeration cycle.
- If refrigerant gas leaks should occur, ventilate the room as soon and as much as possible.
- R410A, as well as other refrigerants, should always be recovered and never be released directly into the environment.
- Use a vacuum pump for R410A exclusively. Using the same vacuum pump for different refrigerants may damage the vacuum pump or the unit.

### ⚠ CAUTION

- It is highly recommended that you do not open/close the stop valves when the outdoor temperature is below -5°F (-21°C) as this may result in refrigerant leakage.

- When piping work is complete, it is necessary to perform a pressure test and evacuate system with a vacuum pump.
- If using additional refrigerant, purge the air from the refrigerant pipes and indoor unit using a vacuum pump, then charge additional refrigerant.
- Use a hexagonal wrench (3/16 inch (4mm)) to operate the stop valve rod.
- All refrigerant pipe joints should be tightened with a torque wrench to the specified tightening torque.

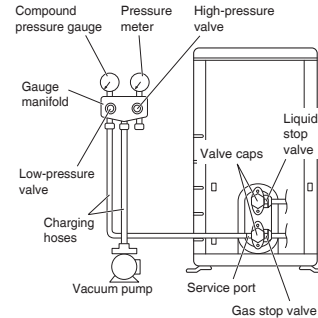

- 1) Pressurize the liquid pipe and gas pipe from the service ports of each stop valve to 604psi (4.17MPa) (do not pressurize more than 604psi (4.17MPa)) for 1 hour minimum, 24 hours recommended. If there is a pressure drop, check for leaks, make repairs and perform the pressure test again.
- 2) Connect the gauge manifold's charging hose to the gas stop valve's service port.
- 3) Fully open the low-pressure valve (Lo) on the gauge manifold and fully close the high-pressure valve (Hi). (High-pressure valve will require no further operation.)
- 4) Evacuate system using vacuum pump to below 500 microns for 1 hour minimum.
- 5) Close the low-pressure valve (Lo) on the gauge manifold and stop vacuum pumping. (Maintain this condition for a few minutes to make sure that the compound pressure gauge pointer does not swing back.)\*1
- 6) Remove the valve caps from the liquid stop valve and gas stop valve.
- 7) To open the liquid stop valve, turn the rod of the valve 90° counter-clockwise using a hexagonal wrench. Close it after 5 seconds, and check for gas leakage. Using soapy water, check for gas leakage from the indoor unit's flare and outdoor unit's flare and valve rods. After the check is complete, wipe all soapy water off.
- 8) Disconnect the charging hoses from the service port for the gas stop valve, then fully open the liquid and gas stop valves. (Do not attempt to turn the valve rods further than they can go.)
- 9) Tighten the valve caps and service port caps for the liquid and gas stop valves with a torque wrench to the specified torques. Refer to "4. Refrigerant piping" on page 6 for details.

\*1 If the compound pressure gauge pointer swings back, the refrigerant may have water content or there may be a loose pipe joint. Check all pipe joints and retighten nuts as needed, then repeat steps 3) through 5).

## 6. Refilling refrigerant

Check the type of refrigerant to be used on the machine nameplate.

### Precautions when adding R410A

#### Fill from the liquid pipe in liquid form.

R410A is a mixed refrigerant, so adding it in gas form may cause the refrigerant composition to change, preventing normal operation.

- Before filling, check whether the cylinder has a siphon attached or not. (It should have something like "liquid filling siphon attached" displayed on it.)

Filling a cylinder with an attached siphon



Stand the cylinder upright when filling.

(There is a siphon pipe inside, so the cylinder need not be upside-down to fill with liquid.)

Filling other cylinders



Turn the cylinder upside-down when filling.

- Be sure to use the R410A tools to ensure pressure and to prevent foreign objects from entering.



# Wiring

## ⚠ WARNING

- Do not ground units to water pipes, gas pipes, telephone wires, or lightning rods as incomplete grounding can cause a severe shock hazard resulting in severe injury or death. Additionally, grounding to gas pipes could cause a gas leak and potential explosion causing severe injury or death.
- Do not use tapped wires, extension cords, or starburst connections, as they may cause overheating, electric shock, or fire.
- Do not use locally purchased electrical parts inside the product. (Do not branch the power for the drain pump, etc., from the terminal block.) Doing so may cause electric shock or fire.
- The circuit must be protected with safety devices in accordance with local and national codes, i.e. a circuit breaker.
- Use an all-pole disconnection type circuit breaker with at least 1/8 inch (3mm) between the contact point gaps.
- When carrying out wiring, take care not to pull at the conduit.
- Do not connect the power wire to the indoor unit. Doing so may cause electric shock or fire.
- Do not turn on the circuit breaker until all work is completed.

## ⚠ CAUTION

### Precautions to be taken for power supply wiring

Recommend stranded cable for interunit wiring. Local code always supersedes recommendation.

- For stranded wires, make sure to use the round crimp-style terminal for connection to the power supply terminal block. Place the round crimp-style terminals on the wires up to the covered part and secure in place.

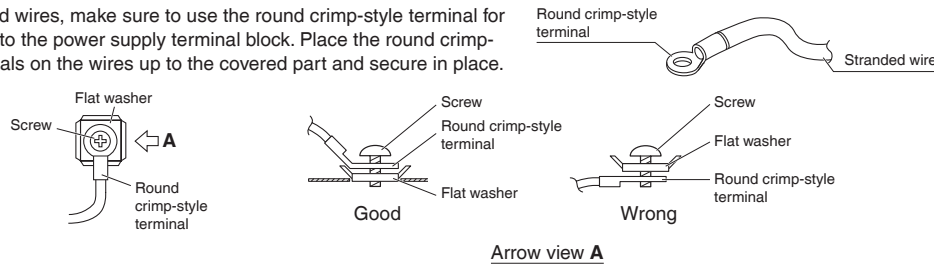

- If solid core wire must be used, be sure to curl the end of the lead. Improper work may cause heat and fire.

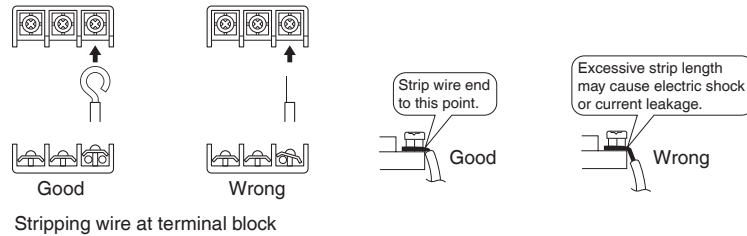

- 1) Strip the insulation from the wire (3/4 inch (20mm)).
- 2) Connect the inter-unit wires between the indoor and outdoor units so that the terminal numbers match. Tighten the terminal screws securely. It is recommended that a slot-head screwdriver be used to tighten the screws.

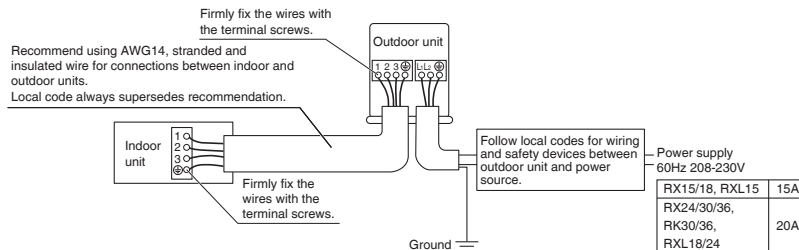

## NOTE

Take care to ensure that all wiring between indoor unit and outdoor unit has a consistent connection. Any splices can cause communication errors.

[Method of mounting conduit]

- 1) Dismount the service lid by removing the 2 screws.
- 2) Pass wires through the conduit and secure them with a lock nut.
- 3) After completing the work, reattach the service lid to its original position.

**RX15/18/24, RXL15 models**

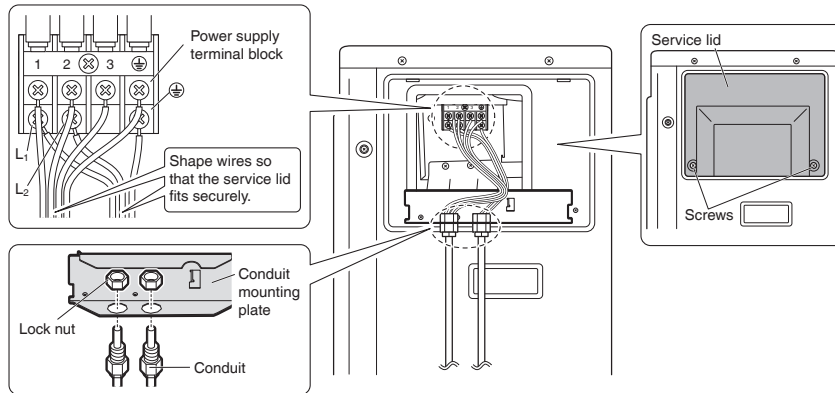

**RX30/36, RK30/36, RXL18/24 models**

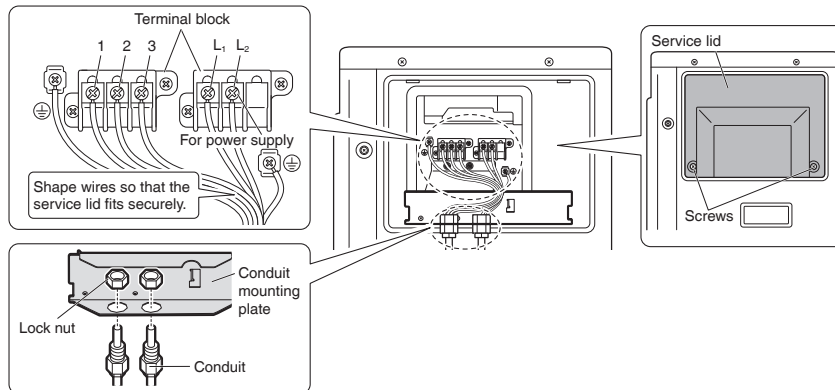

**Ground**

This air conditioner must be grounded. For grounding, follow all local, and state electrical codes.

# Facility Setting (cooling at low outdoor temperature)

**⚠ WARNING**

- Make sure to turn the power OFF before performing work.

**⚠ CAUTION**

- If the outdoor unit is installed where the heat exchanger of the unit is exposed to direct wind, provide a windbreak wall.
- Intermittent noises may be produced by the indoor unit due to the outdoor fan turning on and off when using facility settings.
- Do not place humidifiers or other items which might raise the humidity in rooms where facility settings are being used. A humidifier might cause dew condensation from the indoor unit outlet vent.
- Activating the facility setting sets the indoor fan tap to the highest position. Notify the user about this.

**This function is designed for facilities such as equipment or computer rooms. It is never to be used in a residence or office where people occupy the space.**

**RX15/18/24, RXL15 models**

■ Cutting jumper 6 (J6) on the PCB will extend the operation range to 14°F (-10°C). Installing an air direction adjustment grille (sold separately) will further extend the operation range to -4°F (-20°C). In these cases, the unit will stop operating if the outdoor temperature falls below -4°F (-20°C), restarting once the temperature rises above this level.

- 1) Remove the top plate of the outdoor unit. (6 screws)
- 2) Remove the front plate. (8 screws)
- 3) Remove the anti-drip cover.
- 4) Cut the jumper (J6) of the PCB inside.

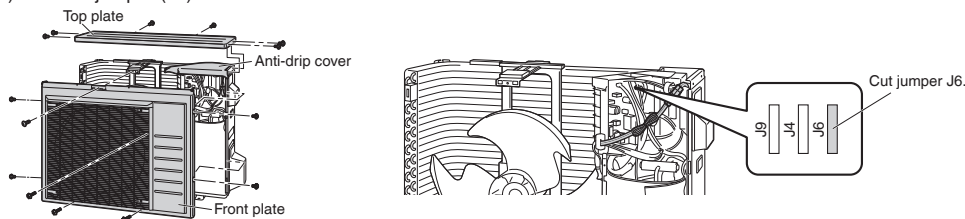

**RX30/36, RK30/36, RXL18/24 models**

■ Turning on SW5-3 on the PCB will extend the operation range to 14°F (-10°C). Installing an air direction adjustment grille (sold separately) will further extend the operation range to -4°F (-20°C). In these cases, the unit will stop operating if the outdoor temperature falls below -4°F (-20°C), restarting once the temperature rises above this level.

- 1) Remove the service lid. (2 screws)
- 2) Remove the switch cover. (1 screw)
- 3) Turn on SW5-3.

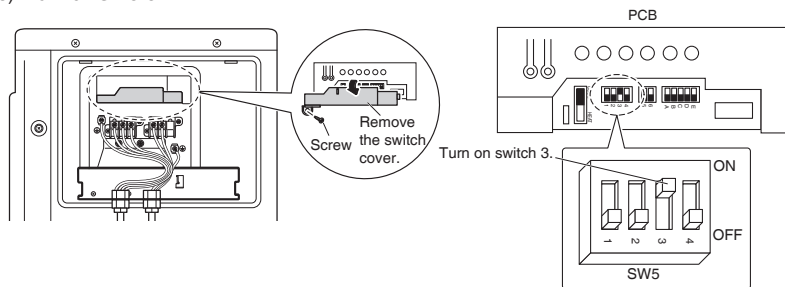

**Only for cooling models**

■ In addition to turning on SW5-3, turning on SW6-2 as well on the PCB will extend the operation range to -22°F (-30°C). The unit will stop operating if the outdoor temperature falls below -22°F (-30°C), restarting once the temperature rises above this level.

- 1) Turn on SW6-2 in addition to SW5-3.

**NOTE**

When the outdoor temperature is below -4°F (-20°C) and if SW6-2 in this step is turned on, for the purpose of protecting the compressor, it may take up to 3 hours for operation to begin while the system warms up.

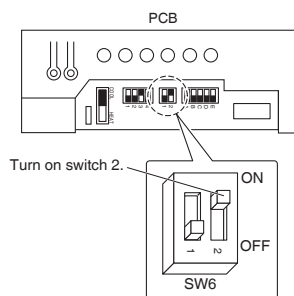

# When attaching the drain pan heater

**⚠ WARNING**

- Make sure to turn the power OFF before performing work.

In high humidity areas or heavy snow areas, it is recommended to attach a drain pan heater to prevent ice build-up from the bottom frame.

**RX15/18/24, RXL15 models**

- 1) Attach the drain pan heater in accordance with the installation manual included with the drain pan heater.
- 2) Cut the jumper (J9) of the PCB inside.

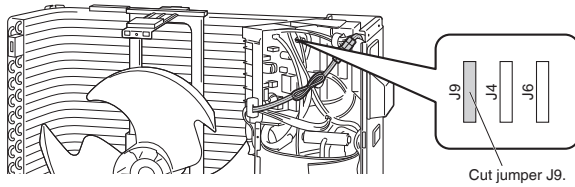

**RX30/36, RK30/36, RXL18/24 models**

- 1) Attach the drain pan heater in accordance with the installation manual included with the drain pan heater.
- 2) Turn on SW6-1 on the PCB.

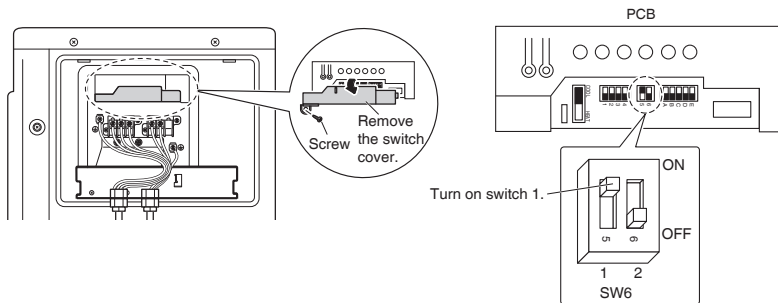

# Pump Down Operation

**In order to protect the environment, be sure to pump down when relocating or disposing of the unit.**

- 1) Remove the valve caps from the liquid stop valve and gas stop valve.
- 2) Begin forced cooling operation.
- 3) After 5 to 10 minutes, close the liquid stop valve with a hexagonal wrench.
- 4) After 2 to 3 minutes, close the gas stop valve and stop forced cooling operation.
- 5) Attach the valve caps once procedures are complete.

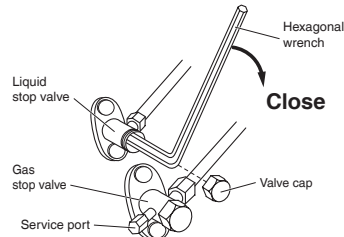

## Forced cooling operation

### ■Using the indoor unit ON/OFF switch [For FTX, FTXR and FVX models]

Press the indoor unit ON/OFF switch for at least 5 seconds.  
(The operation will start.)





- Forced cooling operation will stop automatically after about 15 minutes.  
To stop the operation, press the indoor unit ON/OFF switch.

### ■Using the indoor unit's remote controller [For FFQ and FDMQ models]

[For wired remote controller]







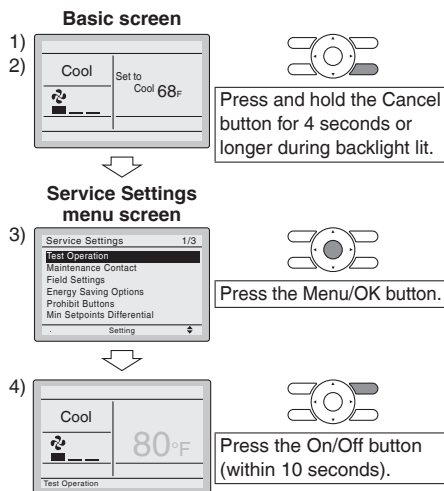

- 1) Set to COOL operation using the remote controller.
- 2) Press and hold the Cancel button for 4 seconds or longer.  
Service settings menu is displayed.
- 3) Select **Test Operation** in the service settings menu, and press the Menu/OK button. Basic screen returns and "Test Operation" is displayed at the bottom.
- 4) Press the On/Off button within 10 seconds, and the forced cooling operation starts.
  - Forced cooling operation will stop automatically after about 15 minutes. To stop the operation, press the On/Off button.

[For wireless remote controller]







- 1) Press  and select the COOL operation.
- 2) Press  twice. "Test" is displayed.
- 3) Press  within 10 seconds, and the forced cooling operation starts.
- Forced cooling operation will stop automatically after about 15 minutes.  
To stop the operation, press .



**[For FTX18/24/30/36, FTXR, FVXS models]**

- 1) Press ,  and  at the same time.
  - 2) Press , select “ 7 ”, and press  for confirmation.
  - 3) Press  and select the COOL operation.
  - 4) Press  to turn on the system.
- Forced cooling operation will stop automatically after about 30 minutes. To stop the operation, press .

**[For FTX15 models]**

- 1) Press ,  and  at the same time.
  - 2) Press , then select 7, press .
  - 3) Press  to turn on the system.
- Forced cooling operation will stop automatically after about 30 minutes. To stop the operation, press .

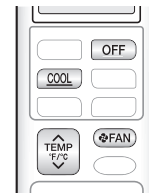

# Trial Operation and Testing

- When trial operation is conducted directly after the circuit breaker is turned on, in some cases no air will be output for about 15 minutes in order to protect the air conditioner.

## 1. Trial operation and testing

Refer to the installation manual for the indoor unit.

## 2. Test items

Test items	Symptom	Check
Indoor and outdoor units are installed securely.	Fall, vibration, noise	
No refrigerant gas leaks.	Incomplete cooling/heating function	
Refrigerant gas and liquid pipes and indoor drain hose extension are thermally insulated.	Water leakage	
Draining line is properly installed.	Water leakage	
System is properly grounded.	Electrical leakage	
Only specified wires are used for all wiring, and all wires are connected correctly.	No operation or burn damage	
Indoor or outdoor unit's air inlet or air outlet are unobstructed.	Incomplete cooling/heating function	
Stop valves are opened.	Incomplete cooling/heating function	
<b>[For FFQ models]</b> Check that the connector of the lead wires of the decoration panel is connected securely.	Louvers do not move	
Indoor unit properly receives remote control commands.	No operation	

## 12.7 <BRC1E73> Wired Remote Controller

# 1. Safety Considerations

The original instructions are written in English. All other languages are translations of the original instructions.

All phases of the field-installation, including, but not limited to, electrical, piping, safety, etc. must be in accordance with manufacturer's instructions and must comply with national, state, provincial and local codes.



Read these **SAFETY CONSIDERATIONS** carefully before installing the remote controller.

After completing the installation, ensure that the remote controller operates properly during the startup operation.

Train the customer to operate and maintain the remote controller. Inform customers that they should store this Installation Manual with the Operation Manual for future reference.

Always use a licensed installer or contractor to install this product. Improper installation can result in electrical shock, fire, or explosion.

Meanings of **WARNING**, **CAUTION**, and **NOTE** Symbols.

 <b>WARNING</b>	Indicates a potentially hazardous situation which, if not avoided, could result in death or serious injury.
 <b>CAUTION</b>	Indicates a potentially hazardous situation which, if not avoided, may result in minor or moderate injury. It may also be used to alert against unsafe practices.
 <b>NOTE</b>	Indicates situations that may result in equipment or property-damage accidents only.

 <b>WARNING</b>
Only qualified personnel must carry out the installation work.
Consult your Daikin dealer regarding relocation and reinstallation of the remote controller. Improper installation work may result in electric shocks or fire.
Electrical work must be performed in accordance with relevant local and national regulations and with instructions in this installation manual. Improper installation may cause electrical shocks or fire.
Use only specified accessories and parts for installation work. Failure to use specified parts may result in electric shocks, fire, or the unit falling.
Do not disassemble, reconstruct, or repair. Electric shock or fire may occur.
Make sure that all wiring is secured, that specified wires are used, and that no external forces act on the terminal connections or wires. Improper connections or installation may result in fire.
Before touching electrical parts, confirm the power-off to the unit.

**⚠ CAUTION**

Keep water out of the remote controller.

To avoid electric shock due to entry of water or insects, fill the wiring through-hole with putty.

Do not wash the remote controller with water as it may result in electrical shocks or fire.

Do not touch the remote controller buttons with wet fingers.

Touching the buttons with wet fingers can cause an electric shock.

Do not install the remote controller in the following locations:

- (a) Where a mineral oil mist or oil spray or vapor is produced, for example, in a kitchen.  
Plastic parts may deteriorate.
- (b) Where corrosive gas, such as sulfurous acid gas, is produced.
- (c) Near machinery emitting electromagnetic waves.  
Electromagnetic waves may disturb the operation of the control system and cause the unit to malfunction.
- (d) Where flammable gas may leak, where there is carbon fiber or ignitable dust suspensions in the air, or where volatile flammables such as thinner or gasoline are handled.  
Operating the unit in such conditions can cause a fire.
- (e) High temperature area or direct flame.  
Overheating and/or fire can occur.
- (f) Moist area, where there is exposure to water. If water enters the inside of the remote controller, it may cause electric shock and electrical components may fail.

**⚠ NOTE**

Install the control wires for the indoor and the remote controller at least 3.5 feet (1 meter) away from televisions or radios to prevent image interference or noise. Depending on the radio waves, a distance of 3.5 feet (1 meter) may not be sufficient to eliminate the noise.







When remote controller's temperature sensor is used, select the installation location as per the following:

- A place where average temperature in the room can be detected.
- A place where it is not exposed to direct sunlight.
- A place where it is far away from any heat source.
- A place where it is not affected directly by outside air.



## 2. Accessories

The following accessories are included.

Drywall screw	Drywall anchor	Wire tie	Operation manual	Installation manual	Wiring retainer
					
(2 pcs.)	(2 pcs.)	(1 pc.)	(1 pc.)	(1 pc.)	(1 pc.)

## 3. Remote Controller Installation Procedure

### 3-1 Determine where to install the remote controller.

Make sure to follow the **Safety Considerations** when determining the location.

### 3-2 If the control wire for the remote controller is to be routed from the rear, consider the location of the access hole in the lower case for making a hole in the wall.

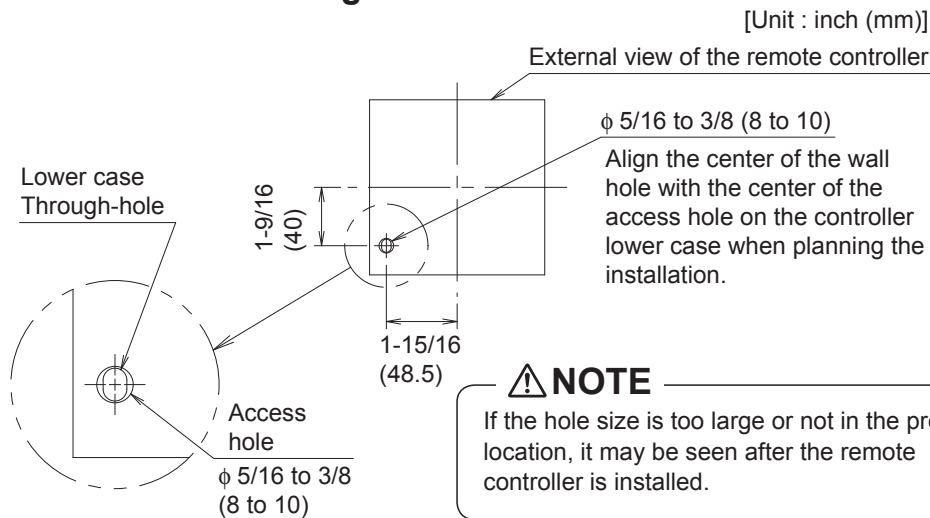

### 3-3 Remove upper case.

Insert a screwdriver in the recess of lower case to remove the upper case (2 points).

Remote controller printed-circuit board is installed on the upper case. Be careful not to damage the printed-circuit board with the screwdriver.

Be careful not to let dust or moisture touch the printed-circuit board.

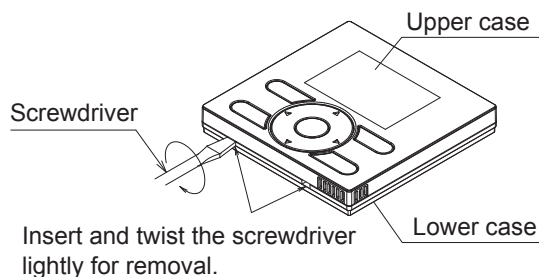

### 3-4 Determine the location where the wiring will enter the remote controller (back, left side, top left, top center).

#### 3-4-1 Back outlet

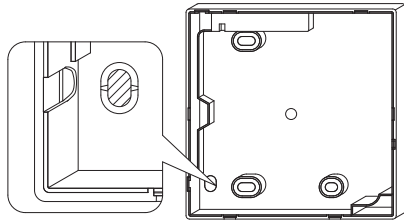

Cut off resin area (notched area).

#### 3-4-2 Left outlet

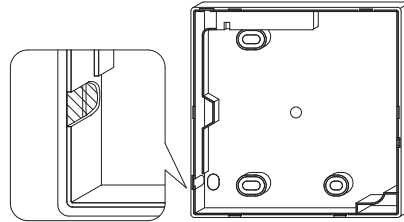

Cut the plastic at the notched area and remove any remaining burrs.

#### 3-4-3 Top left outlet

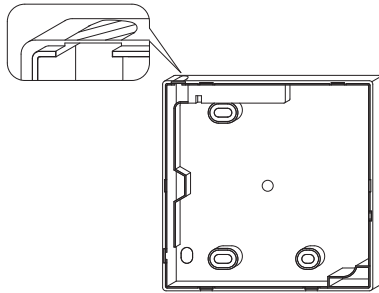

Cut the plastic at the notched area and remove any remaining burrs.

#### 3-4-4 Top center outlet

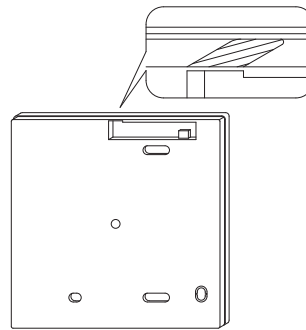

Cut the plastic at the notched area and remove any remaining burrs.

### 3-5 Install wiring.

**⚠ NOTE**

1. Switch box and control wiring are field supplied.
2. Do not touch the remote controller printed-circuit board.

Wiring Specifications

Wiring Type	Non-shielded, 2-conductor, stranded copper wire
Wiring Size	AWG-18
Wiring Length	Maximum 1640 feet (500 m)

Prepare the wiring for connection to the remote controller following these instructions:

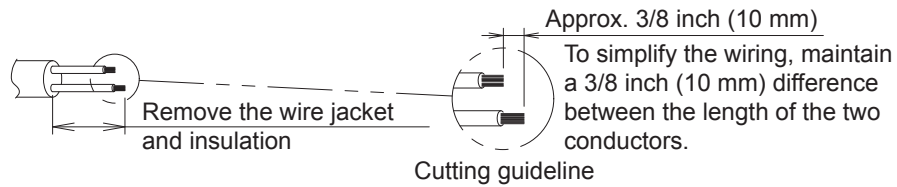

Length of jacket to be removed:

- Approx. 6 inch (150 mm) for top left outlet
- Approx. 8 inch (200 mm) for top center outlet

Connect the terminals (P/P1, N/P2) of the remote controller to the terminals (P1, P2) of the indoor unit. (P1 and P2 are not polarity sensitive.)

### 3-5-1 Back outlet

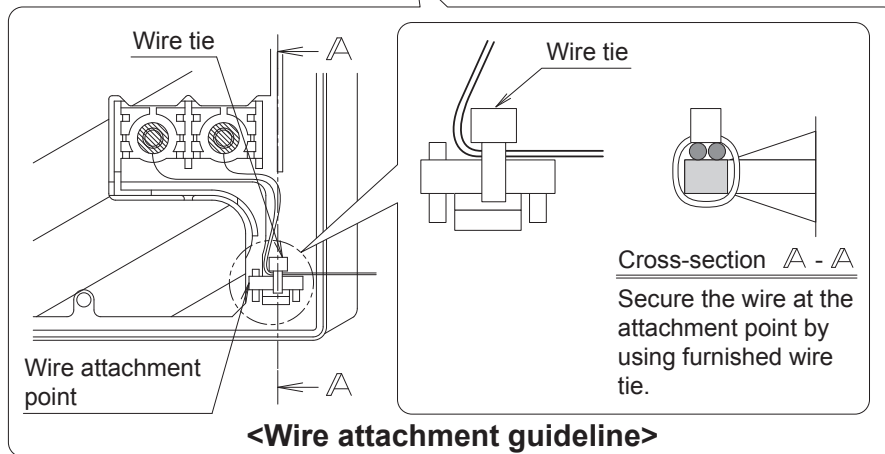
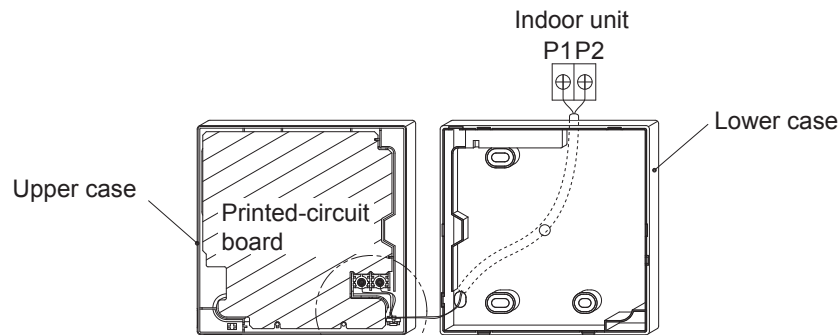

**3-5-2 Left outlet**

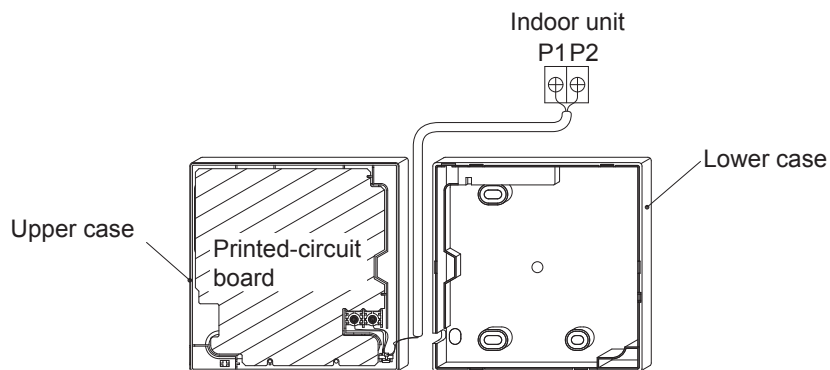

**3-5-3 Top left outlet**

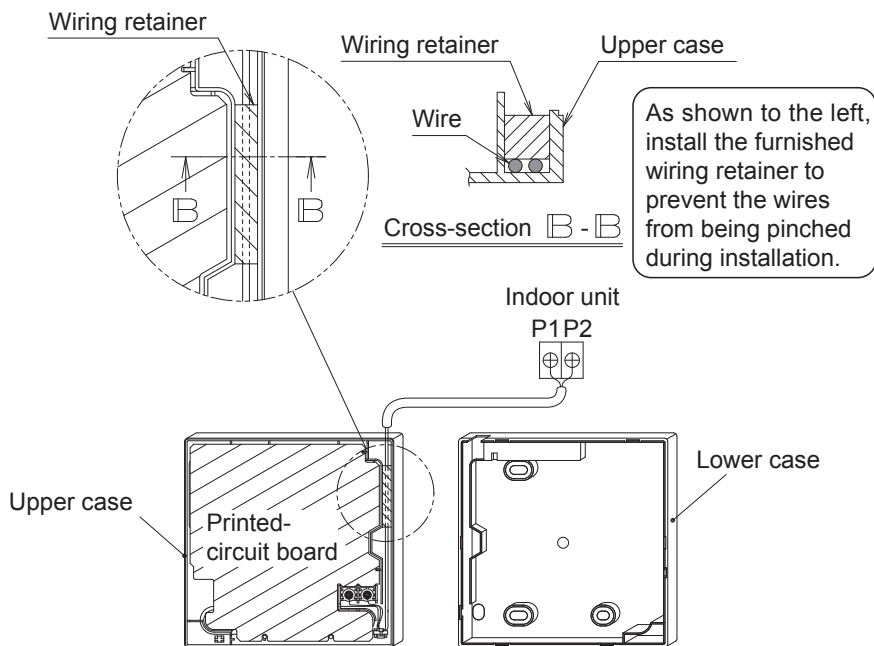

**3-5-4 Top center outlet**

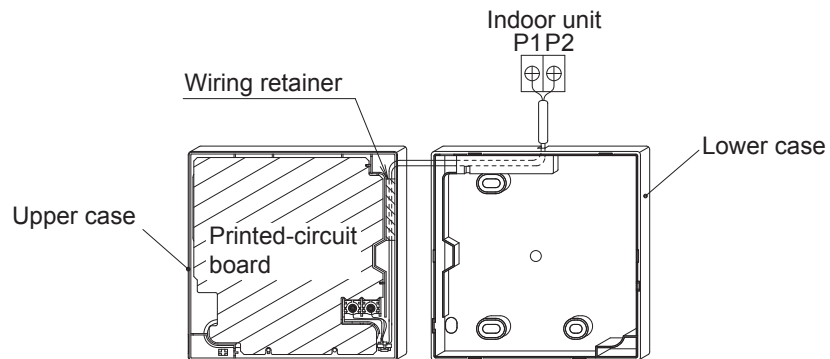

**NOTE**

- To prevent electrical noise and possible communication errors, avoid installing the remote controller wiring parallel to or in the vicinity of line voltage circuits.

**3-6 Installation procedure for the lower case.**

When wiring the remote controller through the top center or rear access points, attachment of the wire to the lower case is required before it is wall mounted. Closely follow the wiring procedures.

**3-6-1 Wall installation**

Secure by using furnished drywall anchors and screws (2 pcs.).

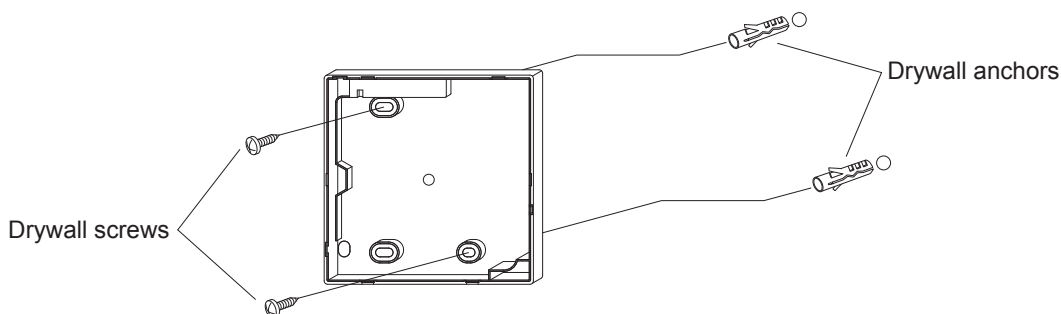

**3-6-2 Switch box installation**

Secure by using field supplied machine screws (2 pcs.).

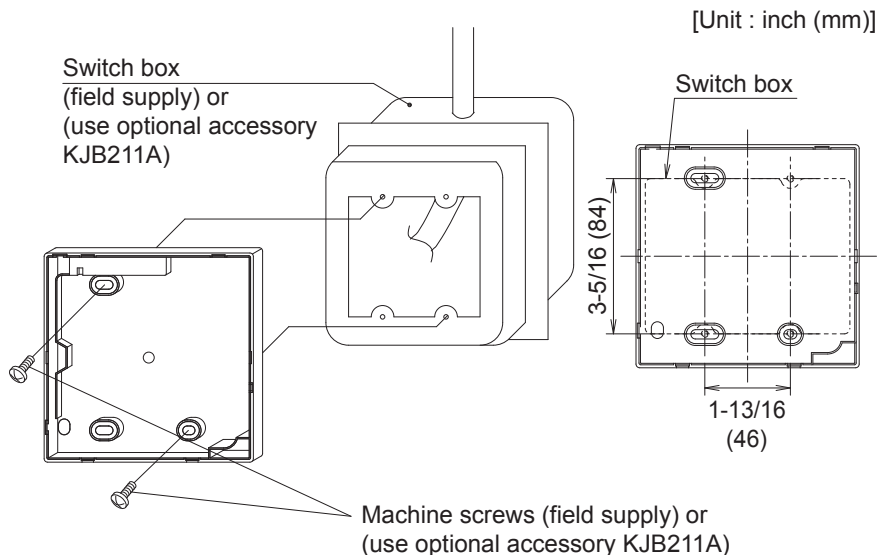

**NOTE**

- Install the control on a flat surface only.
- To prevent deformation of the lower case, avoid over-tightening the installation screws.

### 3-7 Install the upper case.

- Align the upper case with tabs of the lower case (6 points), insert and install the upper case.
- Install the wiring with care to prevent pinching.
- Peel off the protective membrane which overlays the upper case.

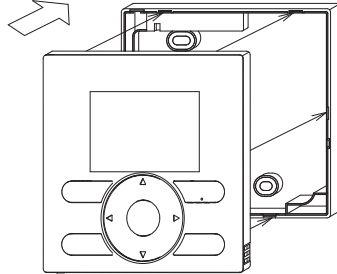

# 4. Functions and Menu Items of Remote Controller Buttons

## 4-1 Functions and menu items

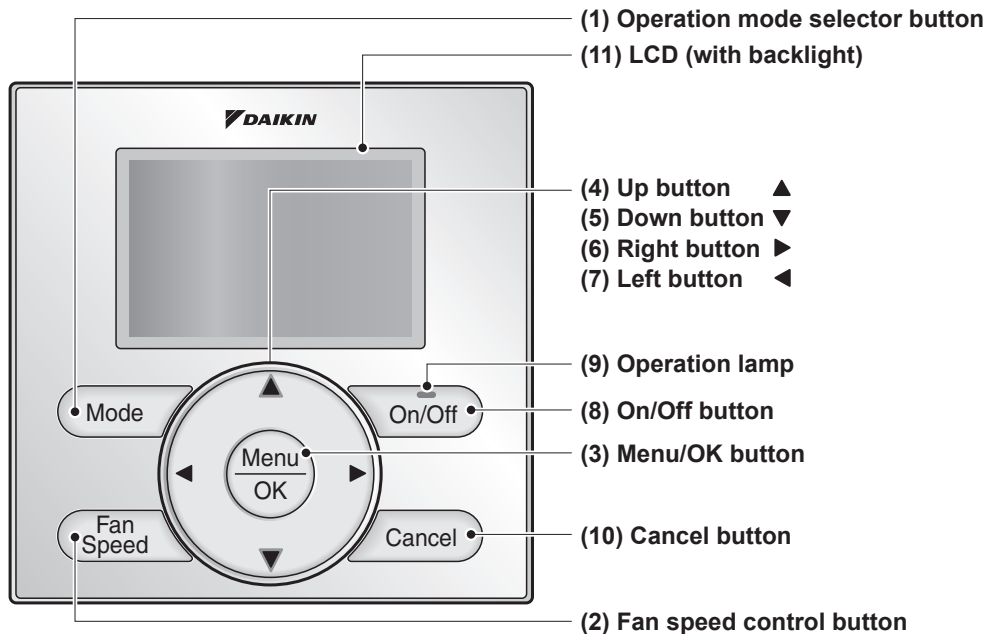

**(1) Operation mode selector button**  
Used to change the mode.

**(2) Fan speed control button**  
Used to change the fan control.

**(3) Menu/OK button**

- Used to access the main menu.  
(For details of the main menu, see the operation manual.)
- Used to enter the item selected.

**Main Menu**

- \*Airflow Direction
- \*Individual Airflow Direction
- \*Ventilation
- Schedule
- Off Timer
- Celsius / Fahrenheit
- Filter Auto Clean
- Maintenance Information
- Configuration
- Current Settings
- Clock & Calendar
- Daylight Saving Time
- Language

\*Depending on connected model

**(4) Up button ▲**

- Used to raise the setpoint temperature.
- The previous menu items will be highlighted.  
(The highlighted items will be scrolled continuously when the button is pressed continuously.)
- Used to change the selected item.

**(5) Down button ▼**

- Used to lower the setpoint temperature.
- Items below the currently selected item will be highlighted.  
(The highlighted items will be scrolled continuously when the button is pressed continuously.)
- Used to change the selected item.

**(6) Right button ►**

- Used to highlight items to the right of the currently selected item.
- Display contents are changed to next screen per page.

**(7) Left button ◀**

- Used to highlight items to the left of the currently selected item.
- Display contents are changed to previous screen per page.

**(8) On/Off button**

Press once to operate, and press once again to stop.

**(9) Operation lamp**

Green lamp lights up during operation. The lamp will flash if a malfunction occurs.

**(10) Cancel button**

- Used to return to the previous screen.
- Press and hold this button for 4 seconds or longer to display service settings menu.

**(11) LCD (with backlight)**

The backlight will illuminate for approximately 30 seconds by pressing any operation button.

**Service Settings menu**

- Test Operation
- Maintenance Contact
- Field Settings
- \*Energy Saving Options
- Prohibit Function
- Min Setpoints Differential
- \*Outdoor unit AirNet Address
- Error History
- \*Indoor Unit Status
- \*Outdoor Unit Status
- Forced Fan ON
- Switch Main Sub Controller
- Filter Indicator
- \*Brush/Filter Ind.
- \*Disable Filter Auto Clean

\*Depending on connected model

**⚠ NOTE**

- Operate the button while the backlight is illuminated.
- When one indoor unit is controlled by two remote controllers (main / sub) only the first controller to be accessed by the user will illuminate it's backlight.

**4-2 Button menu display descriptions**

**<Service settings menu screen>**

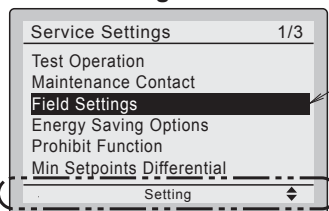

Highlighted display (selected items)

In the highlighted display (selected items) setting screen, button operation descriptions are displayed.



# 5. Power-on

- Check for completion of indoor/outdoor unit wiring.
- Ensure that covers have been replaced on electrical component boxes for both indoor and outdoor units prior to restoring power.

**5-1** The following message is displayed after power-on.  
**Checking the connection.**  
**Please stand by.**

When the above message is displayed, the backlight will not be ON.

**In the case that 1 indoor unit is controlled by 2 remote controllers:**

Make sure to set the sub remote controller when the above message is displayed. Hold **Mode** button for 4 seconds or longer to set.

When the display is changed from “Main RC” to “Sub RC” the setting is completed.

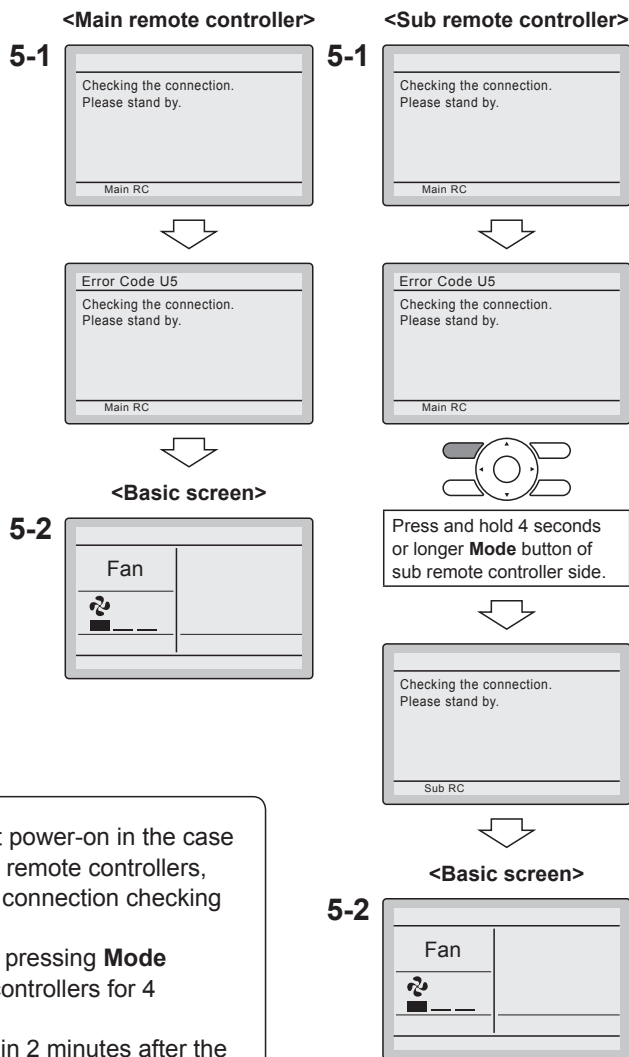

**5-2** Basic screen is displayed.

**NOTE**

If sub remote controller is not set at power-on in the case of one indoor unit controlled by two remote controllers, **Error Code: U5** is displayed in the connection checking screen.

Select the sub remote controller by pressing **Mode** button of either one of the remote controllers for 4 seconds or longer.

If the basic screen is not displayed in 2 minutes after the “Sub RC” is displayed, shut off the power supply and check the wiring.

**NOTE**

When selecting a different language, refer to **Chapter 12. Language.**  
 (See page 22.)

# 6. Field Settings

**6-1** Press and hold **Cancel** button for 4 seconds or longer. Service settings menu is displayed.

**6-2** Select **Field Settings** in the Service Settings menu, and press **Menu/OK** button. Field settings screen is displayed.

**6-3** Highlight the mode, and select desired "Mode No." by using **▲▼** (Up/Down) button.

**6-4** In the case of setting per indoor unit during group control (When Mode No. such as **20**, **21**, **22**, **23**, **25** are selected), highlight the unit No. and select "Indoor unit No." to be set by using **▲▼** (Up/Down) button. (In the case of group setting, this operation is not needed.)

In the case of individual setting per indoor unit, current settings are displayed. And, SECOND CODE NO. " - " means no function.

**6-5** Highlight SECOND CODE NO. of the FIRST CODE NO. to be changed, and select desired "SECOND CODE NO." by using **▲▼** (Up/Down) button. Multiple identical mode number settings are available.

In the case of setting for all indoor units in the remote control group, available SECOND CODE NO. is displayed as " \* " which means it can be changed. When SECOND CODE NO. is displayed as " - ", there is no function.

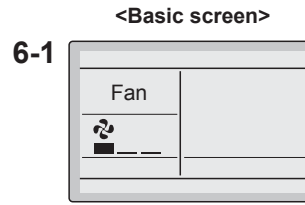

**6-1**



Press and hold **Cancel** button for 4 seconds or longer during backlight lit.



<Service settings menu screen>

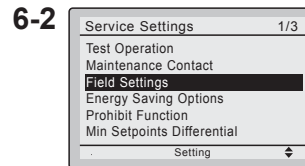

Press **Menu/OK** button.



<Service settings screen>

**In the case of individual setting per indoor unit**

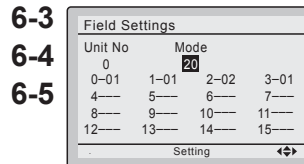

**In the case of group total setting**

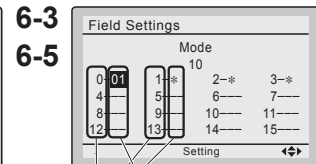

SECOND CODE NO.  
FIRST CODE (SW) NO.



Press **Menu/OK** button.

**6-6** Press **Menu/OK** button. Setting confirmation screen is displayed.

**6-7** Select **Yes** and press **Menu/OK** button. Setting details are determined and field settings screen returns.

**6-8** In the case of multiple setting changes, repeat “**6-3**” to “**6-7**”.

**6-9** After all setting changes are completed, press **Cancel** button twice.

**6-10** Backlight goes out, and **[Checking the connection. Please stand by.]** is displayed for initialization. After the initialization, the basic screen returns.

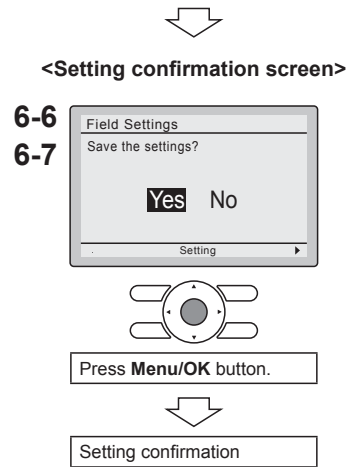

**NOTE**

- Installation of optional accessories on the indoor unit may require changes to field settings. See the manual of the optional accessory.
- For field setting details related to the indoor unit, see installation manual shipped with the indoor unit.

Mode No. (Note 1)	First Code No.	Description	Second Code No. (Note 2) (Items in bold are factory default settings)												
			01	02	03	04	05	06	07	08	09	10	11	12	13
10 (20)	2	Priority of thermistor sensors for space temperature control	The return air thermistor is primary and the remote controller thermistor is secondary.	The remote controller thermistor is not utilized. Only the return air thermistor will be utilized.	Only the remote controller thermistor will be utilized.	—	—	—	—	—	—	—	—	—	
	5	Room temperature value reported to multizone controllers	Return air thermistor	Thermistor designated by 10-2 above (Note 3)	—	—	—	—	—	—	—	—	—	—	
12 (22)	2	Thermo-on/off deadband (Note 4)	2F (1C)	1F (0.5C)	—	—	—	—	—	—	—	—	—		
	1	Thermistor sensor for auto changeover and setback control by the remote controller	Utilize the return air thermistor	Utilize the remote controller thermistor	—	—	—	—	—	—	—	—	—		
	3	Access permission level setting	Level 2	Level 3	—	—	—	—	—	—	—	—	—		
	10	Remote controller thermostat offset (Main RC, Auto mode) (Note 5)	-5.4F (-3.0C)	-4.5F (-2.5C)	-3.6F (-2.0C)	-2.7F (-1.5C)	-1.8F (-1.0C)	-0.9F (-0.5C)	±0.0F (±0.0C)	0.9F (0.5C)	1.8F (1.0C)	2.7F (1.5C)	3.6F (2.0C)	4.5F (2.5C)	5.4F (3.0C)
	11	Remote controller thermostat offset (Sub RC, Auto mode) (Note 5)	-5.4F (-3.0C)	-4.5F (-2.5C)	-3.6F (-2.0C)	-2.7F (-1.5C)	-1.8F (-1.0C)	-0.9F (-0.5C)	±0.0F (±0.0C)	0.9F (0.5C)	1.8F (1.0C)	2.7F (1.5C)	3.6F (2.0C)	4.5F (2.5C)	5.4F (3.0C)
1c	12	Remote controller thermostat offset (Main RC, Cool mode) (Note 5)	-5.4F (-3.0C)	-4.5F (-2.5C)	-3.6F (-2.0C)	-2.7F (-1.5C)	-1.8F (-1.0C)	-0.9F (-0.5C)	±0.0F (±0.0C)	0.9F (0.5C)	1.8F (1.0C)	2.7F (1.5C)	3.6F (2.0C)	4.5F (2.5C)	5.4F (3.0C)
	13	Remote controller thermostat offset (Main RC, Heat mode) (Note 5)	-5.4F (-3.0C)	-4.5F (-2.5C)	-3.6F (-2.0C)	-2.7F (-1.5C)	-1.8F (-1.0C)	-0.9F (-0.5C)	±0.0F (±0.0C)	0.9F (0.5C)	1.8F (1.0C)	2.7F (1.5C)	3.6F (2.0C)	4.5F (2.5C)	5.4F (3.0C)
	14	Remote controller thermostat offset (Sub RC, Cool mode) (Note 5)	-5.4F (-3.0C)	-4.5F (-2.5C)	-3.6F (-2.0C)	-2.7F (-1.5C)	-1.8F (-1.0C)	-0.9F (-0.5C)	±0.0F (±0.0C)	0.9F (0.5C)	1.8F (1.0C)	2.7F (1.5C)	3.6F (2.0C)	4.5F (2.5C)	5.4F (3.0C)
	15	Remote controller thermostat offset (Sub RC, Heat mode) (Note 5)	-5.4F (-3.0C)	-4.5F (-2.5C)	-3.6F (-2.0C)	-2.7F (-1.5C)	-1.8F (-1.0C)	-0.9F (-0.5C)	±0.0F (±0.0C)	0.9F (0.5C)	1.8F (1.0C)	2.7F (1.5C)	3.6F (2.0C)	4.5F (2.5C)	5.4F (3.0C)
	2	Setback availability	N/A	Heat only	Cool only	Cool/Heat	—	—	—	—	—	—	—	—	

- Notes)
1. Field settings are normally applied to the entire remote control group, however if individual indoor units in the remote control group require specific settings or for confirmation that settings have been established, utilize the mode number in parenthesis.
  2. Any features not supported by the connected indoor unit will not be displayed.
  3. When mode 10-2-01 is selected, only the return air temperature value is reported to the multizone controller.
  4. The actual default deadband value will depend upon the indoor unit model.
  5. If different offset values are set for cooling and heating modes, the following issues may occur in auto operation mode:
    - The indoor unit may switch more frequently between cooling/heating modes
    - The indoor unit may switch less frequently between cooling/heating modes
    - Setback on/off may happen more frequently
    - Setback on/off may happen less frequently
 To avoid these issues, set the offset values for auto mode.

## 7. Test Operation

**Also see installation manuals furnished with the indoor unit and the outdoor unit.**

- Verify that the wiring of the indoor unit and the outdoor unit is completed.
- Ensure that covers have been replaced on electrical component boxes for both indoor and outdoor units prior to restoring power.
- After refrigerant piping, drain piping and electric wiring are completed, clean inside of the indoor unit and decorative panel.
- Perform the test operation according to following procedure.
- To protect the compressor, apply power to the outdoor unit at least 6 hours prior to test operation.
- Set the remote controller display mode to standard or detailed display mode. Refer to Operation Manual for the setting method.

### Notes for backlight

- The backlight will be ON for 30 seconds by pressing any button.
- The initial push of the button will only turn on the backlight. While the backlight is turned on, the buttons assigned functionality will be available.

**7-1** Set the operation mode to cooling by using the remote controller.

**7-2** Press and hold **Cancel** button for 4 seconds or longer. Service settings menu is displayed.

**7-3** Select **Test Operation** in the service settings menu, and press **Menu/OK** button. Basic screen returns and message "Test Operation" is displayed at the bottom.

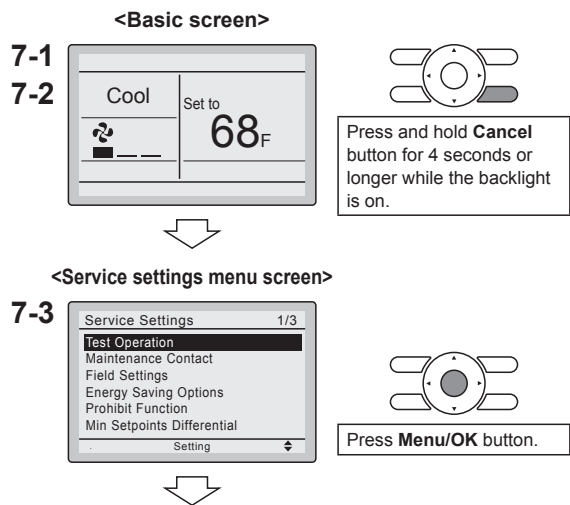

**7-4** Press **On/Off** button within 10 seconds, and the test operation starts. Monitor the operation of the indoor unit for a minimum of 10 minutes. During test operation, the indoor unit will continue to cool regardless of the temperature setpoint and room temperature.

\* Note) In the case of above-mentioned procedures **7-3** and **7-4** in reverse order, test operation can start as well.

**7-5** Press **Menu/OK** button in the basic screen. Main menu is displayed.

**7-6** In the case of a model having airflow direction function, select **Airflow Direction** in the main menu and check that airflow direction is actuated according to the setting. For operation of airflow direction setting, see the operation manual.

**7-7** After the operation of airflow direction is confirmed, press **Menu/OK** button. Basic screen returns.

**7-8** Press and hold **Cancel** button for 4 seconds or longer in the basic screen. Service settings menu is displayed.

**7-9** Select **Test Operation** in the service settings menu, and press **Menu/OK** button. Basic screen returns and normal operation is conducted.  
\* Note) The test operation will automatically finish in 30 minutes.

**7-10** Check the functions according to the operation manual.

**7-11** When the decorative panel is not installed, shut off the power supply after the test operation finishes.

- If construction activities are planned within the space following the test operation procedure, recommend to the customer that the indoor unit is not operated to prevent contamination from paints, drywall dust and other airborne materials.

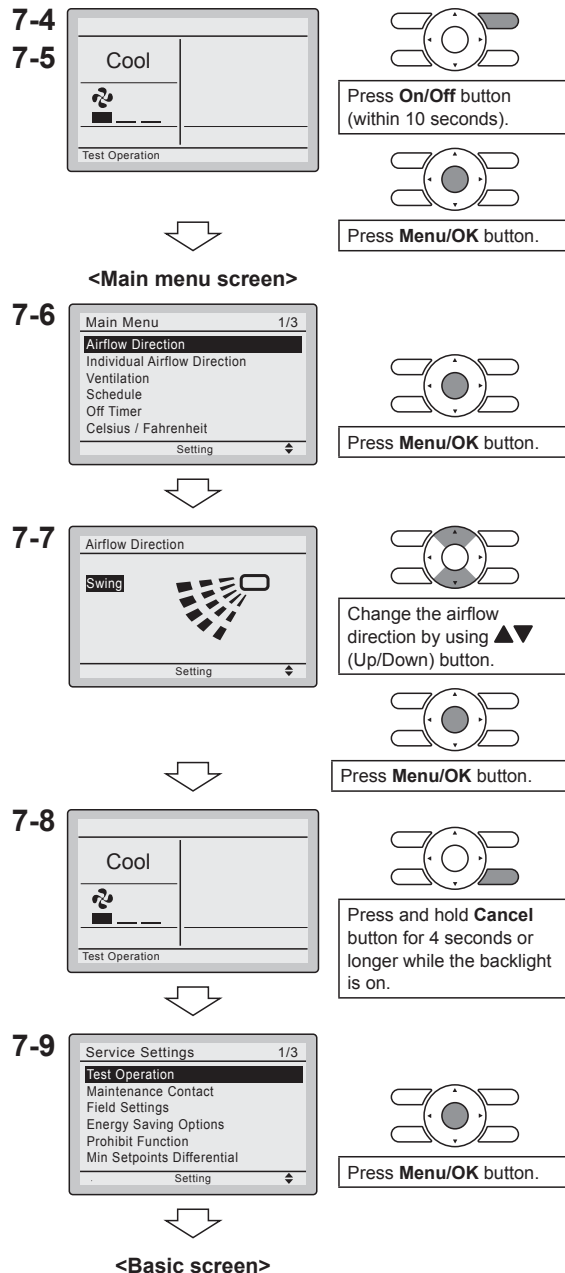

**NOTE**

- If operation is not possible due to a malfunction, refer to following **Failure diagnosis method**.
- After the test operation finishes, check whether the error code history is displayed on the maintenance information screen of the main menu according to the following procedure.

**7-12** Press **Menu/OK** button in the basic screen. Main menu screen is displayed.

**7-13** Select **Maintenance Information** in the main menu, and press **Menu/OK** button.

**7-14** Maintenance information screen is displayed. Check whether the error code history is displayed on the screen.

\* If no error code history is displayed following this procedure the system has normally completed the test operation mode.

**7-15** If the error code history is displayed, conduct the failure diagnosis referring to <Error code list> in the installation manual of the indoor unit. After the failure diagnosis finishes, press and hold **On/Off** button for 4 seconds or longer in the maintenance information screen to erase the error code history.

<Basic screen>

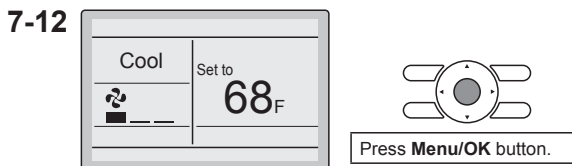

<Main menu screen>

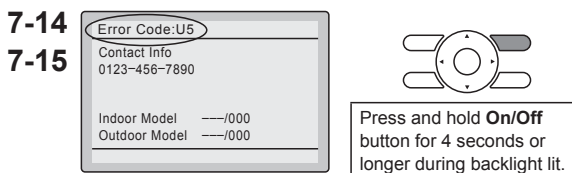
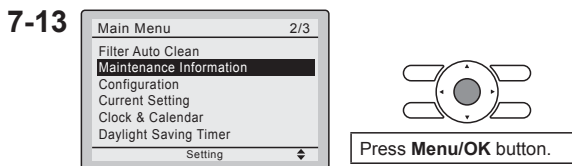

**Failure diagnosis method**

- Whenever the remote controller display is blank or displays [**Checking the connection. Please stand by.**], troubleshoot the system with the items in the Description column of the following table.
- If an error occurs, **CODE** is displayed on the LCD as shown to the right. Conduct the failure analysis referring to <Error code list> in the installation manual of the indoor unit. When the unit No. which detected the error during group control is confirmed, refer to **Chapter 8: Procedure for Checking Error History**.

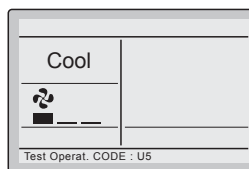

Remote controller display	Description
No display	<ul style="list-style-type: none"> <li>• Power outage, power voltage error or open-phase</li> <li>• Incorrect wiring (between indoor and outdoor units)</li> <li>• Indoor printed-circuit board assembly failure</li> <li>• Remote controller wiring not connected</li> <li>• Remote controller failure</li> <li>• Open fuse or tripped circuit breaker (outdoor unit)</li> </ul>
Checking the connection. Please stand by. *	<ul style="list-style-type: none"> <li>• Indoor printed-circuit board assembly failure</li> <li>• Wrong wiring (between indoor and outdoor units)</li> </ul>

\* [Checking the connection. Please stand by.] will be displayed for up to 90 seconds following the application of power to the indoor unit. This is normal and does not indicate a malfunction.

## 8. Procedure for Checking Error History

**8-1** Press and hold **Cancel** button for 4 seconds or longer in the basic screen. Service settings menu is displayed.

**8-2** Select **Error History** in the service settings menu, and press **Menu/OK** button. The error history menu screen is displayed.

**8-3** Select **RC Error History** in the error history menu, and press **Menu/OK** button.  
Error codes and unit No. can be confirmed in the RC error history screen.

**8-4** In the error history, the 10 most recent items are displayed in order of occurrence.

**8-5** Press **Cancel** button in the RC error history screen 3 times.  
The basic screen returns.

**8-1** <Basic screen>



<Service settings menu screen>

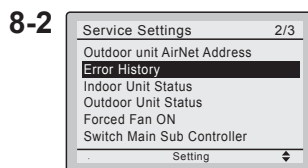

Press **Menu/OK** button.

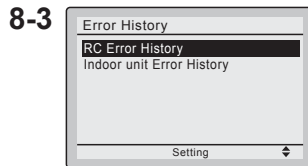

Press **Menu/OK** button.

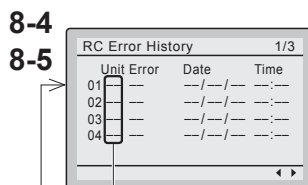

Unit No.  
Latest record



# 9. Adding Maintenance Contact Information

- Registration of the maintenance contact.

- 9-1** Press and hold **Cancel** button for 4 seconds or longer in the basic screen.  
Service settings menu is displayed.
- 9-2** Select **Maintenance Contact** in the service settings menu, and press **Menu/OK** button. Maintenance contact menu screen is displayed.
- 9-3** Select **Maintenance Contact**, and press **Menu/OK** button.
- 9-4** Enter the telephone number.  
Scroll through the numbers by using **▲▼** (Up/Down) buttons. Start from the left side. Blank digits should remain as “-”.
- 9-5** Press **Menu/OK** button.  
Setting confirmation screen is displayed.
- 9-6** Select **Yes** and press **Menu/OK** button.  
Setting details are saved and service settings menu screen returns.
- 9-7** Press **Cancel** button once.  
The basic screen returns.

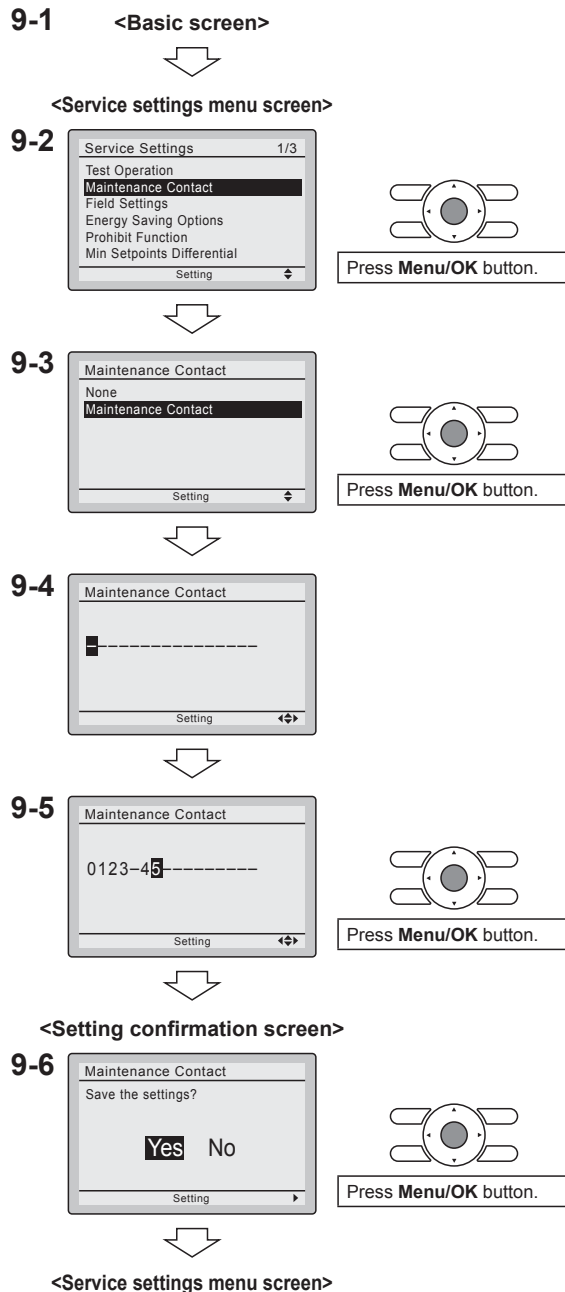

# 10. Confirming Registered Details

**10-1** Press **Menu/OK** button in the basic screen.  
Main menu is displayed.  
Select **Maintenance Information** in the main menu, and press **Menu/OK** button.

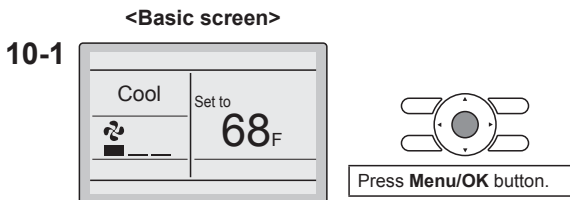

**10-2** Press **Cancel** button twice.  
The basic screen returns.

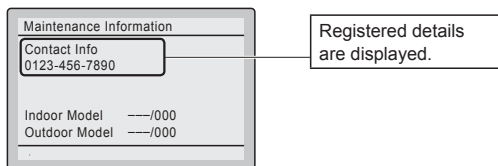
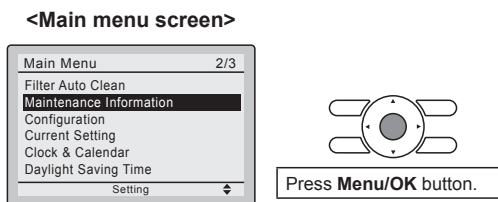

# 11. Clock & Calendar

**11-1** Press **Menu/OK** button in the basic screen.  
Main menu is displayed.  
Select **Clock & Calendar** in the main menu, press **Menu/OK** button.

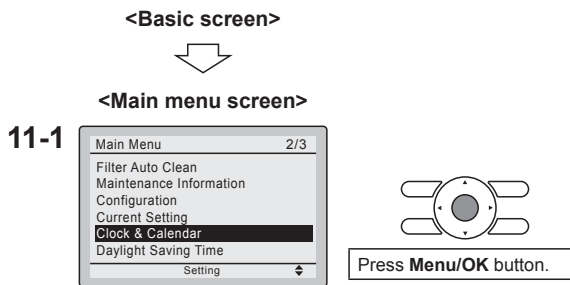

**11-2** Press **▲▼** buttons to select **Date & Time** on the clock & calendar screen.  
\* The date & time screen will appear when **Menu/OK** button is pressed.

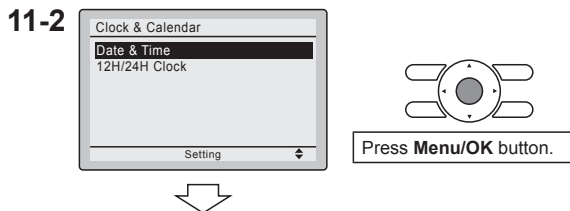

**11-3** Select **year, month, day** and **time** by using ◀▶ (Left/Right) button and set by using ▲▼ (Up/Down) button in the date & time screen. Press and hold the button for continuous change of the numeric value.  
 \* Day of the week is set automatically.

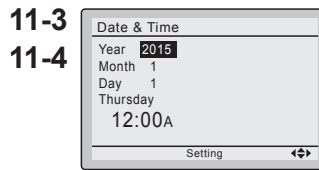

**11-4** Press **Menu/OK** button. Setting confirmation screen is displayed.

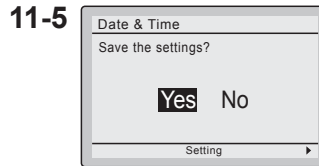

**11-5** Select **Yes** and press **Menu/OK** button. Setting details are saved and basic screen returns.

<Basic screen>

\* If power outage exceeds 48 hours, reset is needed.

## 12. Language

**12-1** Press **Menu/OK** button in the basic screen. Main menu is displayed. Select **Language** in the main menu, press **Menu/OK** button.

<Basic screen>



<Main menu screen>

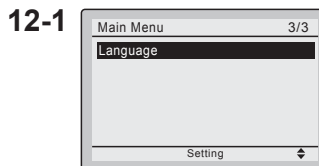

**12-2** Press ▲▼ (Up/Down) buttons to select **Language** on the language screen. **English/Français/Español**. Press **Menu/OK** button.

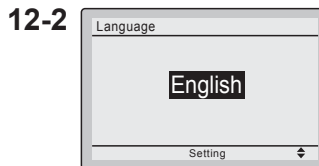

## 12.8 <BRC082A43> Wireless Remote Controller

### CONTENTS

1. SAFETY CONSIDERATIONS.....	2
2. BEFORE INSTALLATION.....	2
3. REMOTE CONTROLLER INSTALLATION.....	2
4. RECEIVER INSTALLATION.....	3
5. FIELD SETTING.....	6
6. TEST OPERATION.....	6

### 1. SAFETY CONSIDERATIONS

Please read these "SAFETY CONSIDERATIONS" carefully before installing air conditioning equipment and be sure to install it correctly. After completing the installation, make sure that the unit operates properly during the start-up operation. Please instruct the customer on how to operate the unit and keep it maintained.

Also, inform customers that they should store this installation manual along with the operation manual for future reference. This air conditioner comes under the term "appliances not accessible to the general public".

Meaning of warning, caution and note symbols.

**⚠ WARNING** ..... Indication a potentially hazardous situation which, if not avoided, could result in death or serious injury.

**⚠ CAUTION** ..... Indication a potentially hazardous situation which, if not avoided, may result in minor or moderate injury. It may also be used to alert against unsafe practices.

**⚠ NOTE** ..... Indication situation that may result in equipment or property-damage-only accidents.

#### **⚠ WARNING**

• **Perform installation work in accordance with this installation manual.**  
Improper installation may result in electric shocks or fire.

• **Be sure to use only the specified accessories and parts for installation work.**

Failure to use the specified parts may result in, electric shocks, fire or the unit falling.

• **Before touching electrical parts, turn off the unit.**

• **Do not touch the switch with wet fingers.**

Touching a switch with wet fingers can cause electric shock.

#### **⚠ CAUTION**

• **Refer also to the installation manuals attached to the indoor unit and the decoration panel.**  
• **Confirm that the following conditions are satisfied prior to installation.**

Ensure that nothing interrupts the operation of the wireless remote controller. (Ensure that there is neither a source of light nor fluorescent lamp near the receiver. Also, ensure that the receiver is not exposed of direct sunlight.)



Ensure that the operation display lamp and other indicators are easy to see.



- The installation position of this receiver is one corner of the decoration panel. Therefore, confirm that its position is set so that the signal from the wireless remote controller can be easily transmitted and its display can be easily seen.
- If both this kit and fresh air intake kit are installed, only one duct chamber shall be used. Refer to the installation manual of the fresh air intake kit (optional hand book).

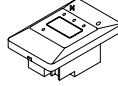
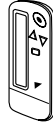

### 2. BEFORE INSTALLATION

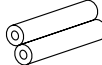

#### 2-1 ACCESSORIES

Check if the following accessories are included with the unit.

Name	(1) Receiver	(2) Wireless remote controller	(3) Remote controller holder
Quantity	1 pc.	1 pc.	1 pc.
Shape			

Name	(4) Dry cell battery LR03 (AM4)	(5) Unit No. label	(6) Screw for installing remote controller holder
Quantity	2 pcs.	1 pc.	2 pcs.
Shape			 M3.5

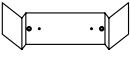
Name	(7) Mounting screw (Black)	(8) Mounting screw	(9) Paper pattern printing
Quantity	2 pcs.	2 pcs.	1 pc.
Shape	 M4	 M5	 3-15/16x1-15/16 (in.)

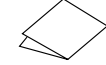
Name	(10) Winged bar	(11) Operation manual	(12) Installation manual
Quantity	1 pc.	1 pc.	1 pc.
Shape			

#### 2-2 NOTE TO THE INSTALLER

Be sure to instruct the customer how to properly operate the system showing him/her the attached operation manual.

### 3. REMOTE CONTROLLER INSTALLATION

#### <Installing wireless remote controller>

- Do not throw the remote controller or impose large shocks. Also, do not store where it may be exposed to moisture or direct sunlight.

- When operating, point the transmitting part of the remote controller in the direction of the receiver.
- The direct transmitting distance of the remote controller is approximately 23 ft..
- The signal cannot be transmitted if something such as curtains blocks the receiver and the remote controller.

**• Installing to a wall or a pillar**

1. Fix the remote controller holder (3) with the screws (6).

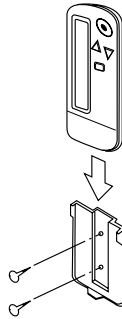

2. Slide the remote controller (2) into the remote controller holder (3) from the top.

**• How to put the dry cell batteries**

1. Remove the back cover of the remote controller (2) to the direction pointed by the arrow mark.
2. Put the dry cell batteries. Use two LR03<AM4> dry cell batteries (4). Put the dry cell batteries (4) correctly to fit their (+) and (-).
3. Close the back cover as before.

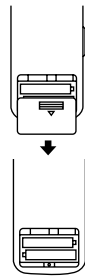

**4. RECEIVER INSTALLATION**

**CAUTION**

- Do not install more than 3 receivers in the vicinity of one another.
- With 4 or more units, there is always the possibility of malfunction.

**4-1. Preparations before installation**

Remove the upper part of the receiver (1).

- Insert the screwdriver (-) here and gently work off the upper part of the receiver (1).

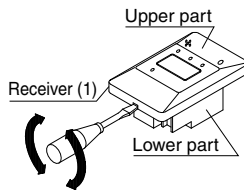

**4-2. Determination of address and MAIN/SUB remote controller**

If setting multiple wireless remote controllers to operate in 1 room, perform address setting for the receiver and the wireless remote controller. If setting multiple wired remote controllers in 1 room, change the MAIN/SUB switch of the receiver.

**4-3. Setting procedure**

- Setting the receiver  
Set the wireless address switch (SS2) on the PC-board according to the table below.

Unit No.	No.1	No.2	No.3
Wireless address switch (SS2)	1 2 3	1 2 3	1 2 3

The side painted black indicates the switch knob position.

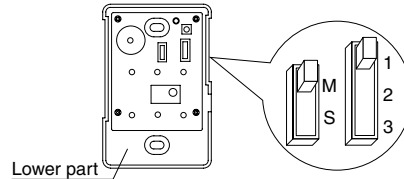

**CAUTION**

Change the setting so that the internal electronic equipments are not damaged with a pen etc.

When using both a wired and a wireless remote controller for 1 indoor unit, the wired controller should be set to MAIN. Therefore, set the MAIN/SUB switch (SS1) of the receiver to SUB.

	MAIN	SUB
MAIN/SUB switch (SS1)	M S	M S

**4-4. Receiver installation**

**WARNING**

Be sure to turn off the power before installation.

**CAUTION**

**<Precautions on transmission wiring>**

1. When wiring, run the wiring away the power supply wiring in order to avoid receiving electric noise (external noise).
2. When wiring, refer to the wiring diagram of indoor unit (attached to indoor unit) as well.

**WIRING SPECIFICATION**

Wiring type	Sheathed wire (2 wire)
Size	AWG18-16
Wiring length	Max 650 ft. (See Note)

**NOTE**

Keep wires to less than 650 ft. total when using 2 remote controllers (wired or wireless) and when not.

**4-5. Attaching the receiver (for ceiling installation)**

1. Prepare the ceiling for the receiver.
  - Open a hole in the ceiling for the receiver. (Use paper pattern printing (9)).

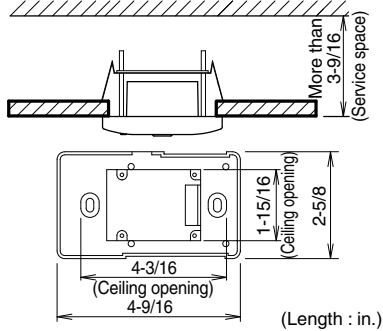

2. Wire the indoor unit and fix the lower part.
  - Install the winged bar (10) to the lower part and fit the part with the screws (8). Then, wire (field supplied) accordingly. (Connect the P1 and P2 terminals on the rear of the lower part to the P1 and P2 terminals on the indoor unit. The P1 and P2 terminals have no polarity.)

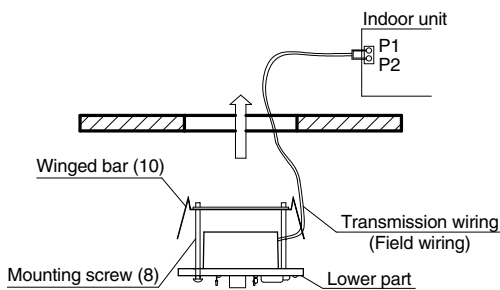

- Insert the lower part into the opening in the ceiling, first by pressing the wings inward to fit the hole and then by pushing from the screws (8) until it sits flat on the ceiling.

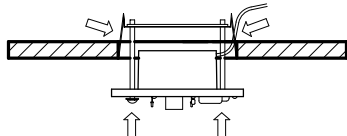

- Tighten the screws (8) until the lower part is fixed in place.

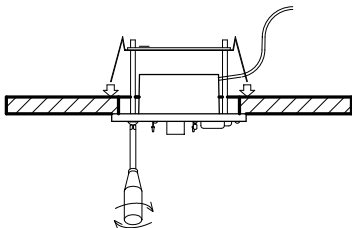

(Tighten both screws (8) evenly. Overtightening may deform the case and possibly make it harder to install the upper part.)

- Attach the upper part of receiver (1).

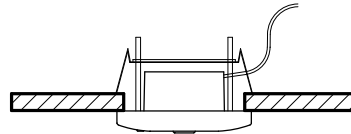

(Install the upper part on the lower part being careful parts are facing in the correct direction. After installation, turn on the power, and test emergency run button.)

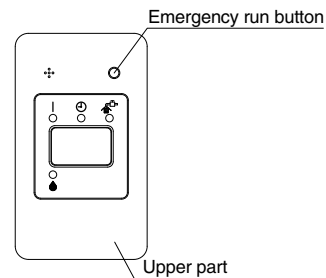

**4-6 Attaching the receiver (for wall mounting)**

1. Wire the indoor unit.

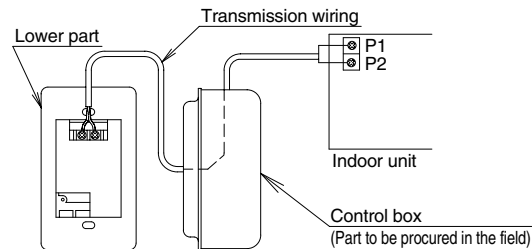

(Connect the P1 and P2 terminals on the rear of the lower part to the P1 and P2 terminals on the indoor unit. Neither of the terminals is polarized, so it is not important if connections are crossed.)

2. Fix the lower part.

- Install the lower part on the control box (field supplied part). (Select as flat a place as possible to install the lower part. Also, be aware of the fact that overtightening the screws (7) may deform the case and possibly make it harder to install the upper part.)

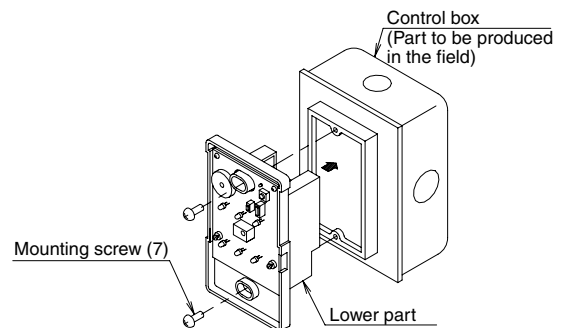

- Attach the upper part of remote controller.  
(Install the upper part on the lower part being careful parts are facing in the correct direction. After installation, turn on the power, and test emergency run button.)

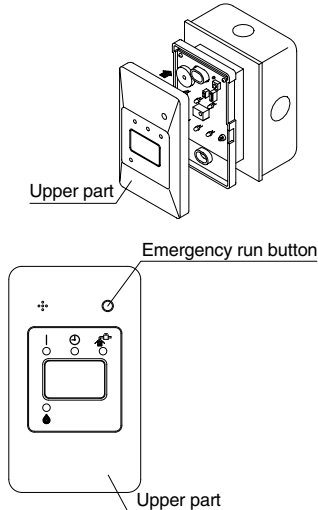

**NOTE**

- The control box and wiring are not included.
- Do not directly touch the PC-board with your hand.

**4-7. Setting the address of wireless remote controller (It is factory set to "1".)**

<Setting from the remote controller>

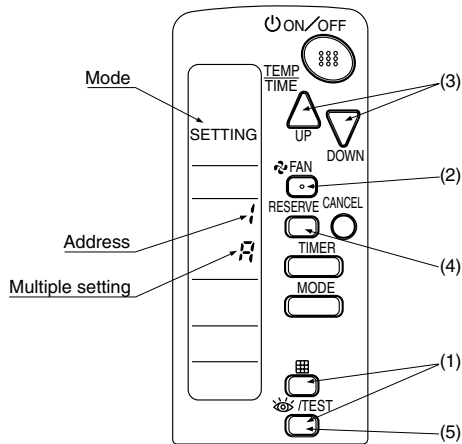

- Hold down the " [Grid] " button and the " [TEST] " button for at least 4 seconds to get the FIELD SET MODE. (Indicated in the display area in the figure at top.)
- Press the " [FAN] " button and select a multiple setting (A/b). Each time the button is pressed the display switches between "A" and "b".

- Press the " [UP] " button and " [DOWN] " button to set the address.

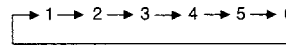

Address can be set from 1 to 6, but set it from 1 to 3 and to same address as the receiver. (The receiver does not work with address from 4 to 6.)

- Press the " [RESERVE] " button to enter the setting.
- Push the " [TEST] " button to quit the FIELD SET MODE and return to the normal display.

<Multiple settings A/b>

When the indoor unit is being operating by outside control (central remote controller, etc.), it sometimes does not respond to ON/OFF and temperature setting commands from this remote controller. Check what setting the customer wants and make the multiple setting as shown below.

Remote controller		Indoor unit	
Multiple setting	Remote controller display	To control other air conditions and units	For other than on left
A: Standard	All items displayed.	Commands other than ON/OFF and temperature setting accepted. (1 LONG BEEP or 3 SHORT BEEPS emitted)	
b: Multi System	Operations remain displayed shortly after execution	All commands accepted. (2 SHORT BEEPS)	

**4-8. Stick the Unit No. label on the receiver and the back of the wireless remote controller.**

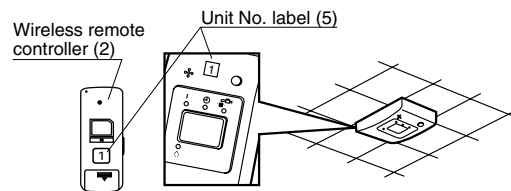

**CAUTION**

Set the Unit No. of the receiver and the wireless remote controller to be equal. If the settings differ, the signal from the remote controller cannot be transmitted.

### 5. FIELD SETTING

If optional accessories are mounted on the indoor unit, the indoor unit setting may have to be changed. Refer to the instruction manual (optional hand book ) for each optional accessory.

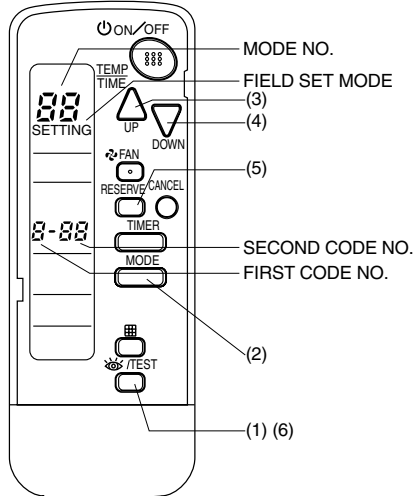

**Procedure**

- (1) When in the normal mode, press the “/TEST” button for at least 4 seconds, and the FIELD SET MODE is entered.
- (2) Select the desired MODE NO. with the “/MODE” button.
- (3) Push the “/UP” button and select the FIRST CODE NO..
- (4) Push the “/DOWN” button and select the SECOND CODE NO..
- (5) Push the “/RESERVE” button and the present settings are set.
- (6) Push the “/TEST” button to quit the FIELD SET MODE and return to the normal display.

(Example) If the time to clean air filter is set to “Filter Contamination-Heavy”, set Mode No. to “10”, FIRST CODE NO. to “0”, and SECOND CODE NO. to “02”.

MODE NO.	FIRST CODE NO.	DESCRIPTION OF SETTING	
10	0	Filter Contamination-Heavy/Light (Setting for spacing time of display time to clean air filter) (Setting for when filter contamination is heavy, and spacing time of display time to clean air filter is to be halved)	Long-life type Standard type
	3	Spacing time of display time to clean air filter count (Setting for when the filter sign is not to be displayed)	
12 (VRV system)	1	ON/OFF input from outside (Set to enable starting/stopping from remote.)	
	2	Thermostat differential changeover (Set when using remote controller thermostat sensor.)	

MODE NO.	FIRST CODE NO.	SECOND CODE NO.		
		01	02	03
10	0	Light Approx. 2,500 hours Approx. 200 hours	Heavy Approx. 1,250 hours Approx. 100 hours	—
	3	Display	Do not display	—
12 (VRV system)	1	Forced OFF input	ON/OFF	—
	2	2°F	1°F	—

**NOTE**  
 The SECOND CODE NO. is factory set to "01".  
 Do not use any settings not listed in the table.  
 For group control with a wireless remote controller, initial settings for all the indoor units of the group are equal. (For group control, refer to the installation manual attached to the indoor unit for group control.)

### 6. TEST OPERATION

- Perform test operation according to the instructions in the installation manual attached to the indoor unit.
- After refrigerant piping, drain piping, and electric wiring, operate according to the table to protect the unit.

**CAUTION**

1. Refer to a malfunction code in the installation manual attached to the outdoor unit if it does not operate.
2. Refer to the installation manual attached to the outdoor unit for individual operation system types.  
 Some of our product types should have the power supply turned ON 6 hours before starting operation in order to electrify crank case heater.  
 Refer to the installation manual attached to the outdoor unit.

Order	Operation
(1)	Open gas side stop valve.
(2)	Open liquid side stop valve.
(3)	Set to cooling with the remote controller and push “/ON/OFF” button to start operation.
(4)	Push“ /TEST” button twice and operate in TEST OPERATION MODE for 3 minutes.
(5)	Push“ /TEST” button and operate normally.
(6)	Confirm its function according to the operation manual.



# 13. Operation Manual

## 13.1 FTX09/12/15

### Read Before Operation

# Safety Considerations

Refer also to the General Safety Considerations in the separate booklet.



**Read the precautions in this manual carefully before operating the unit.**

Read these **Safety Considerations for Operations** carefully before operating an air conditioner or heat pump.

Make sure that the unit operates properly during the startup operation. Instruct the user on how to operate and maintain the unit.

Inform users that they should store this operation manual with the installation manual for future reference.

Meanings of **DANGER**, **WARNING**, **CAUTION**, and **NOTE** Symbols:

**⚠ DANGER** ..... Indicates an imminently hazardous situation which, if not avoided, will result in death or serious injury.

**⚠ WARNING** ..... Indicates a potentially hazardous situation which, if not avoided, could result in death or serious injury.

**⚠ CAUTION** ..... Indicates a potentially hazardous situation which, if not avoided, may result in minor or moderate injury. It may also be used to alert against unsafe practices.

**⚠ NOTE** ..... Indicates situations that may result in equipment or property damage accidents only.

#### ⚠ DANGER

- Do not install the unit in an area where flammable materials are present due to risk of explosion resulting in serious injury or death.
- Any abnormalities in the operation of the air conditioner or heat pump, such as smoke or fire, could result in severe injury or death. Turn off the power and contact your dealer immediately.
- Refrigerant gas may produce toxic gas if it comes into contact with fire, such as from a fan heater, stove, or cooking device. Exposure to this gas could cause severe injury or death.
- For refrigerant leakage, consult your dealer. Refrigerant gas is heavier than air and replaces oxygen. A massive leak could lead to oxygen depletion, especially in basements, and an asphyxiation hazard could occur leading to serious injury or death.
- If equipment utilizing a burner is used in the same room as the air conditioner or heat pump, there is the danger of oxygen deficiency which could lead to an asphyxiation hazard resulting in serious injury or death. Be sure to ventilate the room sufficiently to avoid this hazard.
- Safely dispose of the packing materials. Packing materials, such as nails and other metal or wooden parts, may cause stabs or other injuries.
- Tear apart and throw away plastic packaging bags so that children will not play with them. Children playing with plastic bags face the danger of death by suffocation.

#### ⚠ WARNING

- Contact your dealer for repair and maintenance. Improper repair and maintenance may result in water leakage, electric shock, and fire. Only use accessories made by Daikin that are specifically designed for use with the equipment and have them installed by a professional.
- Contact your dealer to move and reinstall the air conditioner or heat pump. Incomplete installation may result in water leakage, electric shock, and fire.
- Never let the indoor unit or the remote controller get wet. Water can cause an electric shock or a fire.
- Never use flammable spray such as hair spray, lacquer, or paint near the unit. Flammable spray may cause a fire.
- When a fuse blows out, never replace it with one of incorrect ampere ratings or different wires. Always replace any blown fuse with a fuse of the same specification.
- Never remove the fan guard of the unit. A fan rotating at high speed without the fan guard is very dangerous.
- Never inspect or service the unit by yourself. Contact a qualified service person to perform this work.
- Turn off all electrical power before doing any maintenance to avoid the risk of serious electric shock; never sprinkle or spill water or liquids on the unit.
- Do not touch the switch with wet fingers. Touching a switch with wet fingers can cause electric shock.
- Do not allow children to play on or around the unit to prevent injury.
- The heat exchanger fins are sharp enough to cut. To avoid injury wear gloves or cover the fins while working around them.
- Do not put a finger or other objects into the air inlet or air outlet. The fan is rotating at high speed and will cause injury.
- Check the unit foundation for damage on a continuous basis, especially if it has been in use for a long time. If left in a damaged condition the unit may fall and cause injury.
- Placing a flower vase or other containers with water or other liquids on the unit could cause a shock or fire if a spill occurs.
- Do not touch the air outlet or horizontal blades while the swing flap is in operation because fingers could get caught and injured.
- Never touch the internal parts of the controller. Do not remove the front panel because some parts inside are dangerous to touch. To check and adjust internal parts, contact your dealer.
- Do not use means to accelerate the defrosting process or to clean, other than those recommended by the manufacturer.
- The appliance must be stored in a room without continuously operating ignition sources (for example: open flames, an operating gas appliance or an operating electric heater).
- Do not pierce or burn.
- Be aware that refrigerants may not contain an odor.

**Read Before Operation**

**⚠ CAUTION**

- Do not use the air conditioner or heat pump for any other purposes other than comfort cooling or heating. Do not use the unit for cooling precision instruments, food, plants, animals or works of art.
- Do not place items under the indoor unit as they may be damaged by condensates that may form if the humidity is above 80% or if the drain outlet gets blocked.
- Before cleaning, stop the operation of the unit by turning the power off or by pulling the supply cord out from its receptacle. Otherwise, an electric shock and injury may result.
- Do not wash the air conditioner or heat pump with excessive water. An electric shock or fire may result.
- Avoid placing the controller in a spot which may be splashed with water. Water entering the controller may cause an electric shock or damage the internal electronic parts.
- Do not operate the air conditioner or heat pump when using a room-fumigation type of insecticide. Failure to observe this could cause the chemicals to be deposited in the unit and can endanger the health of those who are hypersensitive to chemicals.
- Do not turn off the power immediately after stopping operation. Always wait for at least 5 minutes before turning off the power. Otherwise, water leakage may occur.
- The appliance is not intended for use by young children or infirm persons without supervision.
- The remote controller should be kept away from children so they cannot play with it.
- Consult with the installation contractor for cleaning.
- Incorrect cleaning of the inside of the air conditioner or heat pump could make the plastics parts break and cause water leakage or electric shock.
- Do not touch the air inlet or aluminum fin of the air conditioner or heat pump as they can cut and cause injury.
- Do not place objects in direct proximity of the outdoor unit. Do not let leaves and other debris accumulate around the unit. Leaves are a hotbed for small animals which can enter the unit. Once inside the unit, animals can cause the unit to malfunction, and cause smoke or fire when they make contact with electrical parts.

**⚠ NOTE**

- Never press the button of the remote controller with a hard, pointed object. The remote controller may be damaged.
- Never pull or twist the electric wire of the remote controller. It may cause the unit to malfunction.
- Do not place appliances that produce open flames in places that are exposed to the airflow of the unit or under the indoor unit. It may cause incomplete combustion or deformation of the unit due to the heat.
- Do not expose the controller to direct sunlight. The LCD display can become discolored and may fail to display the data.

- Do not wipe the controller operation panel with benzine, thinner, chemical dust cloth, etc. The panel may get discolored or the coating can peel off. If it is heavily dirty, soak a cloth in water-diluted neutral detergent, squeeze it well and wipe the panel clean. Then wipe it with another dry cloth.
- Dismantling of the unit, disposal of the refrigerant, oil, and additional parts, should be done in accordance with the relevant local, state, and national regulations.
- Operate the air conditioner or heat pump in a sufficiently ventilated area and not surrounded by obstacles. Do not use the air conditioner or heat pump in the following places.
  - a. Places with a mist of mineral oil, such as cutting oil.
  - b. Locations such as coastal areas where there is a lot of salt in the air.
  - c. Locations such as hot springs where there is a lot of sulfur in the air.
  - d. Locations such as factories where the power voltage varies a lot.
  - e. In cars, boats, and other vehicles.
  - f. Locations such as kitchens where oil may splatter or where there is steam in the air.
  - g. Locations where equipment produces electromagnetic waves.
  - h. Places with an acid or alkaline mist.
  - i. Places where fallen leaves can accumulate or where weeds can grow.
- Take snow protection measures. Contact your dealer for the details of snow protection measures, such as the use of a snow protection hood.
- Do not attempt to do electrical work or grounding work unless you are licensed to do so. Consult with your dealer for electrical work and grounding work.
- Pay attention to operating sound. Be sure to use the following places:
  - a. Places that can sufficiently withstand the weight of the air conditioner or heat pump yet can suppress the operating sound and vibration.
  - b. Places where warm air from the air outlet of the outdoor unit or the operating sound of the outdoor unit does not annoy neighbors.
- Make sure that there are no obstacles close to the outdoor unit. Obstacles close to the outdoor unit may drop the performance of the outdoor unit or increase the operating sound of the outdoor unit.
- Consult your dealer if the air conditioner or heat pump in operation generates unusual noise.
- Make sure that the drainpipe is installed properly to drain water. If no water is discharged from the drainpipe while the air conditioner or heat pump is in the cooling mode, the drainpipe may be clogged with dust or dirt and water leakage from the indoor unit may occur. Stop operating the air conditioner or heat pump and contact your dealer.
- Do not spray the air conditioner unit with any deodorizers, etc. It may cause the unit to malfunction.

FTP002M-U

**Read Before Operation**

# Names of Parts 09/12 class

## Indoor Unit

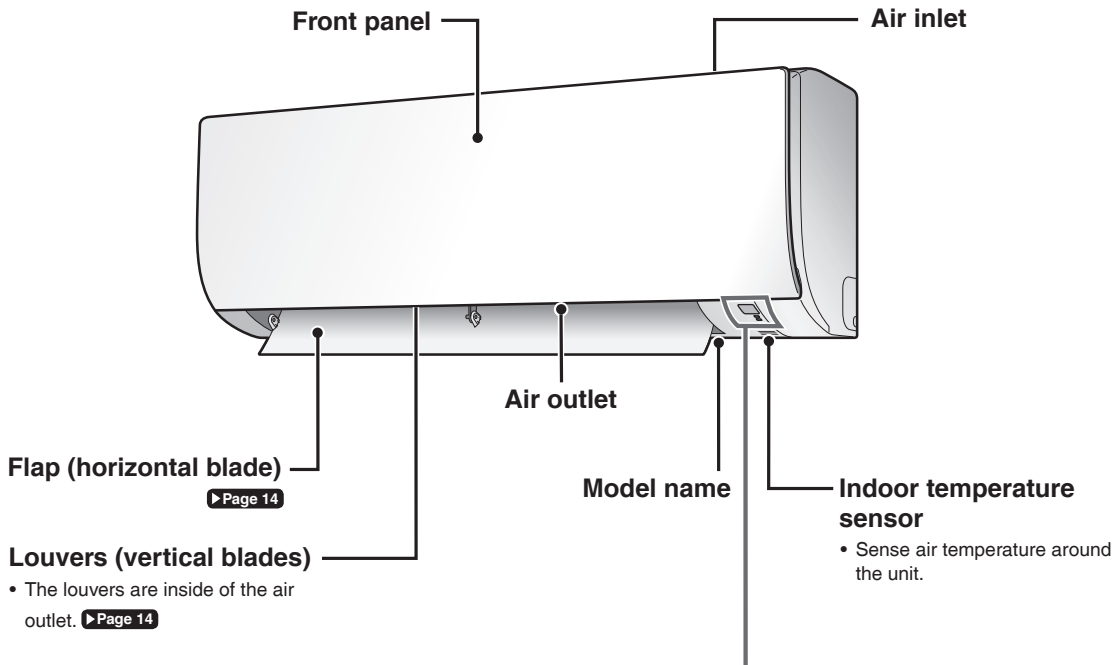

### Display

**Signal receiver**

- Receives signals from the remote controller.
- When the unit receives a signal, you will hear a beep sound.

Case	Sound type
Operation start	beep-beep
Setting changed	beep
Operation stop	long beep

**OPERATION lamp (green)**  
▶ Page 11

**TIMER lamp (orange)**  
▶ Page 17, 18

**Indoor unit ON/OFF switch**

- Press this switch once to start operation. Press once again to stop it.
- For the operation mode setting, refer to the following table.

Mode	Temperature setting	Airflow rate
AUTO	77°F (25°C)	AUTO

- This switch can be used when the remote controller is missing or out of batteries.

**Read Before Operation**

■ **Open the front panel**

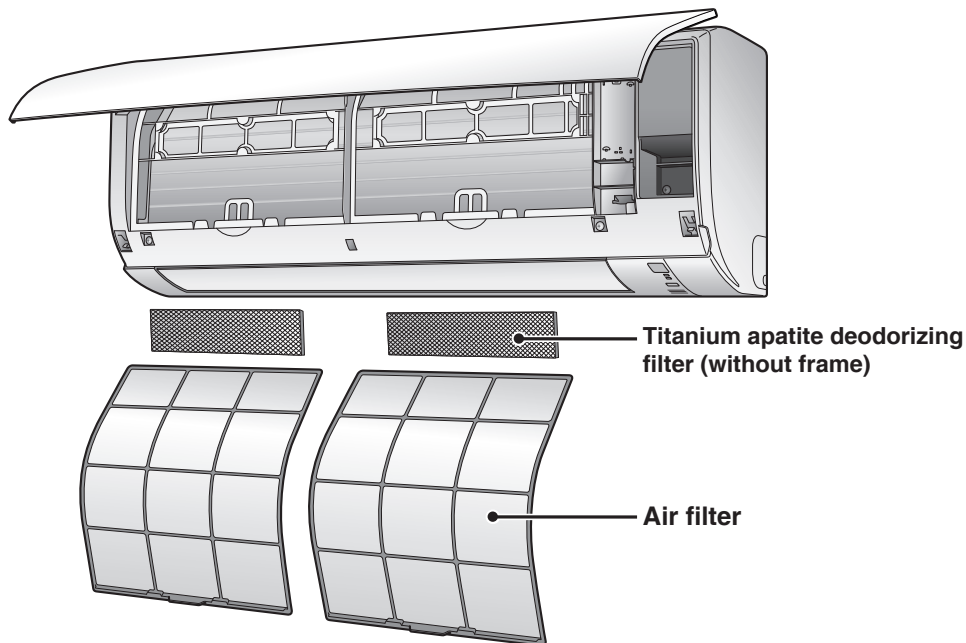

**Outdoor Unit**

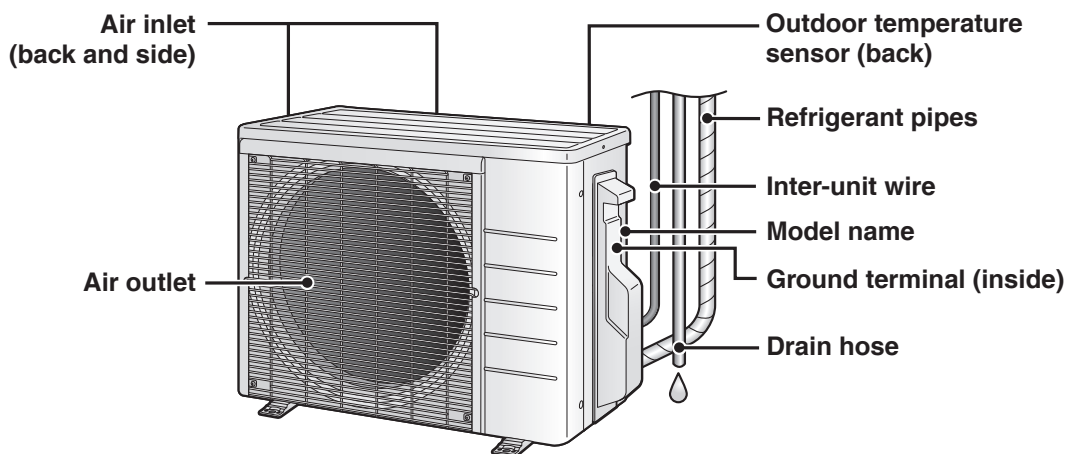

**Read Before Operation**

# Names of Parts 15 class

## Indoor Unit

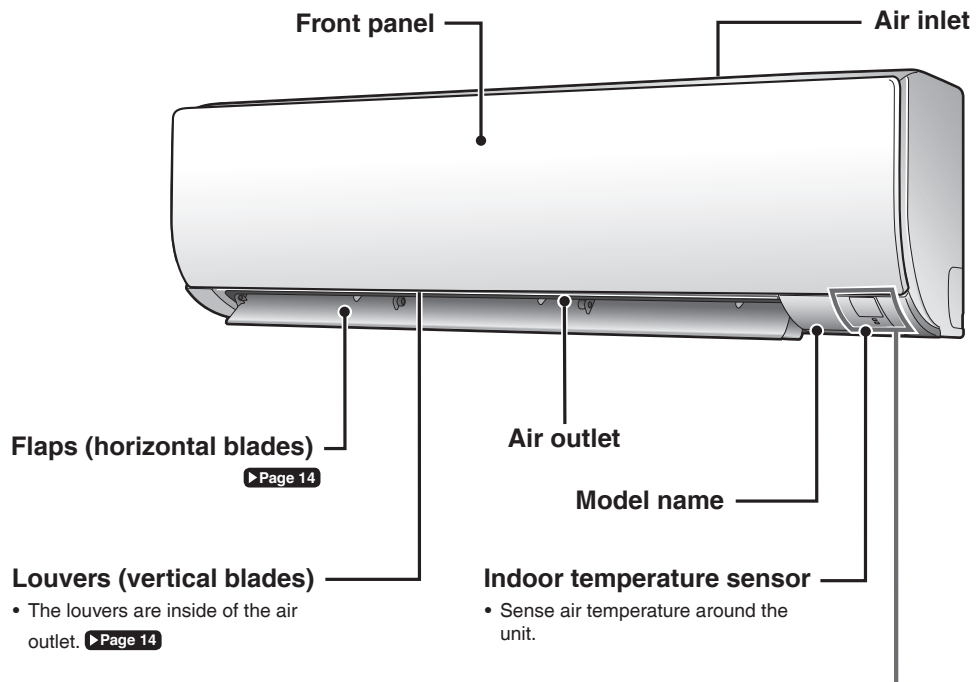

### Display

**Signal receiver**

- Receives signals from the remote controller.
- When the unit receives a signal, you will hear a beep sound.

Case	Sound type
Operation start	beep-beep
Setting changed	beep
Operation stop	long beep

**OPERATION lamp (green)**  
▶ Page 11

**TIMER lamp (orange)**  
▶ Page 17, 18

**Indoor unit ON/OFF switch**

- Press this switch once to start operation. Press once again to stop it.
- For the operation mode setting, refer to the following table.

Mode	Temperature setting	Airflow rate
AUTO	77°F (25°C)	AUTO

- This switch can be used when the remote controller is missing or out of batteries.

**Read Before Operation**

■ **Open the front panel**

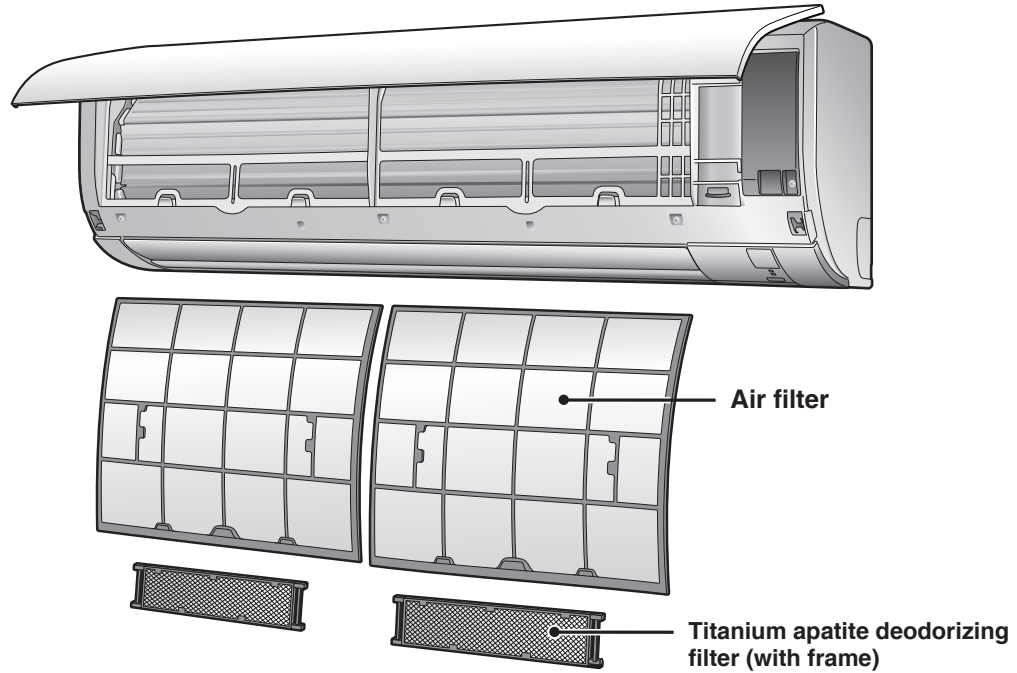

**Outdoor Unit**

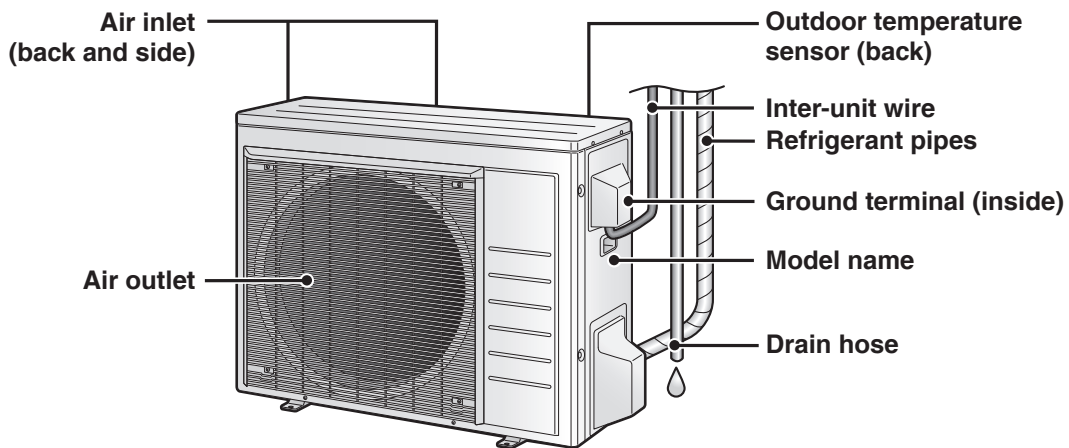

**Read Before Operation**

# Names of Parts

## Remote Controller

**Display (LCD)**

- Displays the current settings. (In this illustration, each section is shown with its displays on for the purpose of explanation.)

**AUTO button**

- Automatically selects an appropriate operation mode (COOL or HEAT) based on the indoor temperature and starts the operation. ▶Page 11

**Direct operation buttons**

- Starts the COOL, DRY, HEAT or FAN ONLY operation. ▶Page 11

**TEMPERATURE adjustment button**

- Changes the temperature setting. ▶Page 12

**COMFORT button**

- COMFORT AIRFLOW operation. ▶Page 15

**POWERFUL button**

- POWERFUL operation. ▶Page 15

**OFF TIMER button (NIGHT SET mode)** ▶Page 18

**ON TIMER button** ▶Page 17

**Signal transmitter**

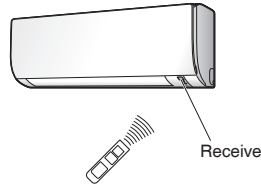

- To use the remote controller, aim the transmitter at the indoor unit. If there is anything blocking the signals between the unit and the remote controller, such as a curtain, the unit may not operate.
- The maximum transmission distance is about 23ft (7m).

**OFF button**

- Stops the operation. ▶Page 12

**FAN setting button**

- Selects the airflow rate setting. ▶Page 13

**ECONO button**

- ECONO operation. ▶Page 16

**SWING button**

- Adjusts the airflow direction. ▶Page 14

**TIMER CANCEL button**

- Cancels the timer setting. ▶Page 18

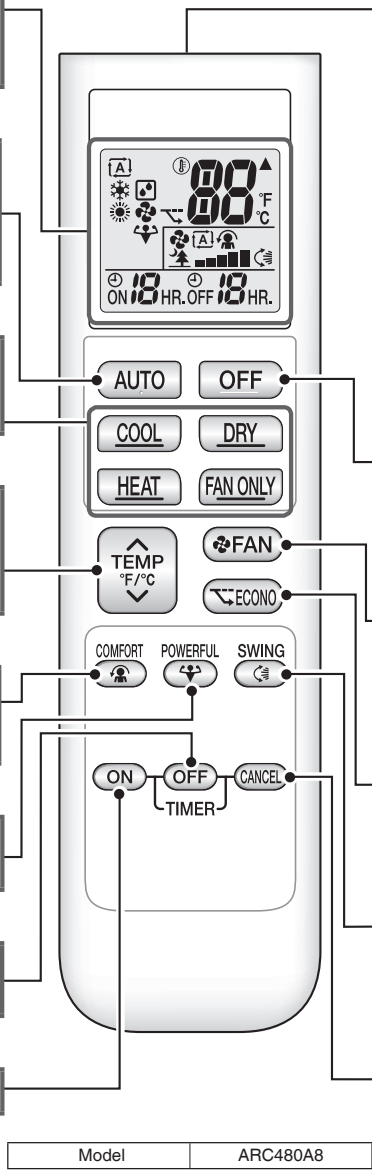

Model      ARC480A8

**Read Before Operation**

# Preparation Before Operation

## CAUTION

**Incorrect handling of batteries can result in injury from battery leakage, rupturing or heating, or lead to equipment failure.**

**Please observe the following precautions and use safely.**

- If the alkaline solution from the batteries should get in the eyes, do not rub the eyes. Instead, immediately flush the eyes with tap water and seek the attention of a medical professional.
- Keep batteries out of reach of children. In the event that batteries are swallowed, seek the immediate attention of a medical professional.
- Do not expose batteries to heat or fire. Do not disassemble or modify batteries. The insulation or gas release vent inside the battery may be damaged, resulting in battery leakage, rupturing, or heating.
- Do not damage or peel off labels on the batteries.

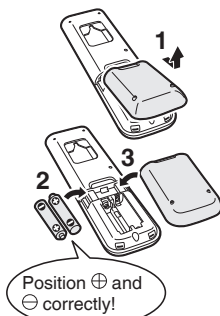

### To insert the batteries

- 1. Remove the back cover by sliding and then slightly lifting it.**
- 2. Insert 2 dry batteries AAA.LR03 (alkaline).**
- 3. Replace the back cover.**

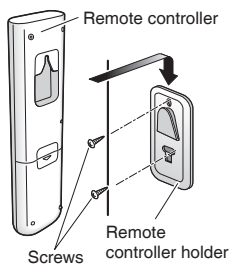

### To attach the remote controller holder to a wall

- 1. Choose a place where the signals reach the unit.**
- 2. Attach the holder to a wall, a pillar, or similar location with the screws supplied with the holder.**
- 3. Hang the remote controller on the remote controller holder.**

### Fahrenheit/Celsius display switch

▶ Press  and  (TIMER button) simultaneously for about 5 seconds.

- The temperature will be displayed in Celsius when it is presently displayed in Fahrenheit, and vice versa.
- The switch operation is only possible when the temperature is being displayed.
- A reception sound will go off for the transmission of set temperature to the indoor unit at the time of setting the Fahrenheit/Celsius display change function.

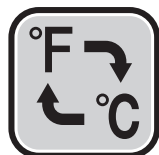

### Turn on the circuit breaker

- After the power is turned on, the flap of the indoor unit opens and closes once to set the reference position.

## NOTE

### Notes on batteries

- To avoid possible injury or damage from battery leakage or rupturing, remove the batteries when not using the product for long periods of time.
- The standard replacement time is about 1 year. Both batteries should be replaced at the same time. Be sure to replace them with new dry batteries AAA.LR03 (alkaline).
- If the remote controller display begins to fade and signal reception begins to decline, replace the batteries with new batteries. Owing to usage conditions, battery consumption may be accelerated.
- The batteries supplied with the remote controller are for initial operation. The batteries may run out in less than 1 year.

### Notes on remote controller

- Do not drop the remote controller. Do not get it wet.
- If dirt becomes an issue, wipe with a soft dry cloth.

### Fahrenheit/Celsius display change function of remote controller

- The set temperature may increase when the display is changed to Celsius from Fahrenheit, because a fraction of 0.5°C is rounded up.
- Example: A set temperature of 65°F (equivalent to 18.5°C) will be converted into 19°C. When the display is changed to Fahrenheit again, the set temperature will be converted into 66°F (equivalent to 19°C) instead of the original set temperature (65°F) but a set temperature of 66°F (equivalent to 19°C) will be converted into 19°C with no temperature change.



**Basic Operation**



# AUTO · COOL · DRY · HEAT · FAN ONLY Operation



The air conditioner operates with the operation mode of your choice.

**To start operation**

**AUTO operation**

- To automatically select an appropriate temperature and operation mode.

Press **AUTO** .



**COOL operation**

- To lower the temperature.

Press **COOL** .



**DRY operation**

- To lower the humidity.

Press **DRY** .



**HEAT operation**

- To raise the temperature.

Press **HEAT** .



**FAN ONLY operation**

- To circulate air in the room.

Press **FAN ONLY** .



- The OPERATION lamp lights green.

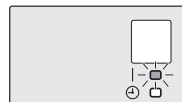

Display

**NOTE**

**Notes on AUTO operation**

- In AUTO operation, the system selects an appropriate operation mode (COOL or HEAT) based on the indoor temperature and starts the operation.
- The system automatically reselects setting at a regular interval to bring the indoor temperature to the user-setting level.

**Note on DRY operation**

- Eliminates humidity while maintaining the indoor temperature as much as possible. It automatically controls temperature and airflow rate, so manual adjustment of these functions is unavailable.

**Basic Operation**

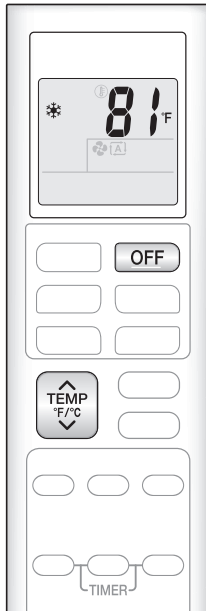

**To stop operation**

Press **OFF** .

- The OPERATION lamp goes off.

**To change the temperature setting**

Press **TEMP F/°C** .

- Press **▲** to raise the temperature and press **▼** to lower the temperature.

COOL operation	HEAT operation	AUTO operation	DRY or FAN ONLY operation
64-90°F (18-32°C)	50-86°F (10-30°C)	64-86°F (18-30°C)	The temperature setting cannot be changed.

**Tips for saving energy**

**Keeping the temperature setting at a moderate level helps save energy.**

- Recommended temperature setting
  - For cooling: 78-82°F (26-28°C)
  - For heating: 68-75°F (20-24°C)

**Cover windows with a blind or a curtain.**

- Blocking sunlight and air from outdoors increases the cooling (heating) effect.

**Keep the air filters clean.**

- Clogged air filters cause inefficient operation and waste energy. Clean them once in about every 2 weeks. [▶ Page 20, 23](#)

**If you are not going to use the air conditioner for a long period, for example in spring or autumn, turn off the circuit breaker.**

- The air conditioner always consumes a small amount of electricity even while it is not operating.



**Basic Operation**



# Adjusting the Airflow Rate



You can adjust the airflow rate to increase your comfort.

**To adjust the airflow rate setting**

Press **FAN**.

- Each pressing of **FAN** changes the airflow rate setting in sequence.



- When the airflow is set to “”, quiet operation starts and noise from the indoor unit will become quieter. However, it may become difficult to cool (or warm) the room.
- In the quiet operation mode, the airflow rate is set to a weak level.

AUTO, COOL, HEAT and FAN ONLY operation				DRY operation
				The airflow rate setting cannot be changed. (only AUTO)
				AUTO

**NOTE**

**Note on airflow rate setting**

- At smaller airflow rates, the cooling (heating) effect is also smaller.

**Note on AUTO airflow rate**

- When using AUTO airflow rate, the airflow rate is adjusted according to conditions in the room.



## Adjusting the Airflow Direction

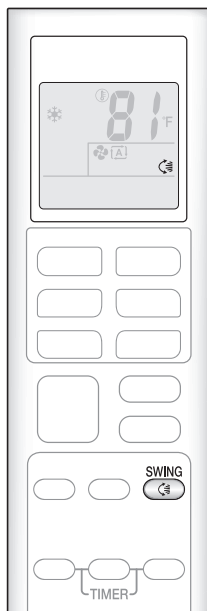

You can adjust the airflow direction to increase your comfort.

### CAUTION

- Always use a remote controller to adjust the angles of the flap. Moving the flap forcibly by hand may cause a malfunction.
- Be careful when adjusting the louvers. Inside the air outlet, a fan is rotating at a high speed.

### To start auto swing

#### Up and down airflow direction

Press **SWING** .

- “” is displayed on the LCD.
- The flap (horizontal blade) will begin to swing.

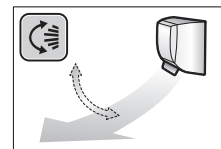

### To set the flap at the desired position

- This function is effective while the flap is in auto swing mode.

Press **SWING**  when the flap reaches the desired position.

- “” disappears from the LCD.

### To adjust the louvers at desired position

Hold the knobs and move the louvers (vertical blades).

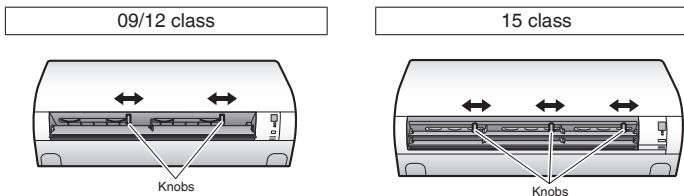

### NOTE

#### Notes on airflow direction setting

- The movable range of the flap varies according to the operation mode.
- If the airflow rate becomes weak during operation, the flap will stop.  
When up and down airflow direction is set, the flap will stop in an upward position.

#### Movable range of the flap

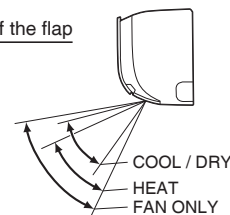

**Useful Functions**



## COMFORT AIRFLOW Operation

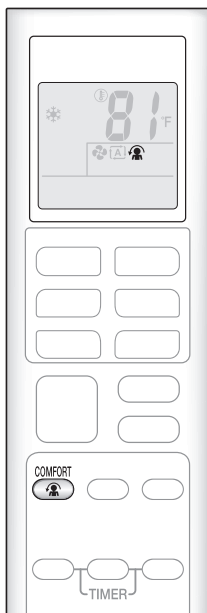

The flow of air will be in the upward direction while in COOL and DRY operation and in the downward direction while in HEAT operation, which will provide a comfortable airflow that will not come in direct contact with people.

### To start COMFORT AIRFLOW operation

Press  .

- “” is displayed on the LCD.

	COOL and DRY operation	HEAT operation	FAN operation
Flap direction	Goes up	Goes down	Not available
Airflow rate	AUTO		

- When in AUTO operation, the flap direction differs based on the operation mode (COOL or HEAT) as shown in the table above.

### To cancel COMFORT AIRFLOW operation

Press  again.

- “” disappears from the LCD.
- The flap will return to the memory position from before COMFORT AIRFLOW operation.



## POWERFUL Operation



POWERFUL operation quickly maximizes the cooling (heating) effect in any operation mode. In this mode, the air conditioner operates at maximum capacity.

### To start POWERFUL operation

Press  .

- “” is displayed on the LCD.
- POWERFUL operation ends in 20 minutes. Then the system automatically operates again with the previous settings which were used before POWERFUL operation.

### To cancel POWERFUL operation

Press  again.

- “” disappears from the LCD.

**Useful Functions**



# ECONO Operation

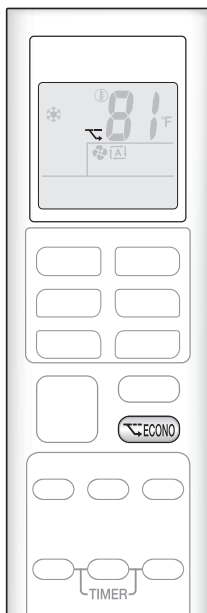

ECONO operation enables efficient operation by limiting the maximum power consumption.

This function is useful to prevent the circuit breaker from tripping when the unit operates alongside other appliances on the same circuit.

**To start ECONO operation**

▶ Press .

- “” is displayed on the LCD.
- Not available in FAN ONLY mode.

**To cancel ECONO operation**

▶ Press again.

- “” disappears from the LCD.

**NOTE**

**Notes on COMFORT AIRFLOW operation**

- The airflow rate will be set to AUTO.
- If the up and down airflow direction is selected, the COMFORT AIRFLOW operation will be canceled.

**Notes on POWERFUL operation**

- Pressing causes the settings to be canceled, and “” disappears from the LCD.
- POWERFUL operation will not increase the capacity of the air conditioner if the air conditioner is already in operation with its maximum capacity demonstrated.

**- In COOL, HEAT and AUTO operation**

To maximize the cooling (heating) effect, the capacity of outdoor unit increases and the airflow rate becomes fixed at the maximum setting. The temperature and airflow settings cannot be changed in COOL and HEAT operation. Airflow settings cannot be changed in AUTO operation.

**- In DRY operation**

The temperature setting is lowered by 4.5°F (2.5°C) and the airflow rate is slightly increased.

**- In FAN ONLY operation**

The airflow rate is fixed at the maximum setting.

**Notes on ECONO operation**

- This operation is performed with lower power and therefore may not provide a sufficient cooling (heating) effect.
- Pressing causes the settings to be canceled, and “” disappears from the LCD.
- If the power consumption level is already low, switching to ECONO operation will not reduce the power consumption.

**Some useful functions can be used together.**

COMFORT AIRFLOW + ECONO	Available
POWERFUL + COMFORT AIRFLOW	Not available*
POWERFUL + ECONO	Not available*

\*Priority is given to the function of whichever button is pressed last.

**TIMER Operation**



# ON/OFF TIMER Operation

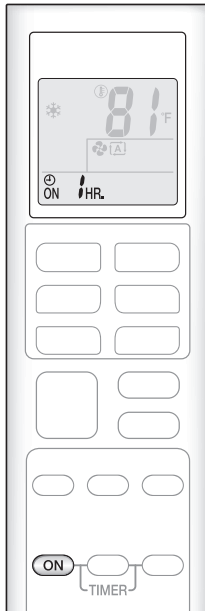

Timer functions are useful for automatically switching the air conditioner on or off in the morning or at night. You can also use the ON TIMER and OFF TIMER together.

**To use ON TIMER operation**

● Press **ON** .

- Each pressing of **ON** changes the time setting by 1 hour. The time can be set between 1 and 12 hours.
- The TIMER lamp lights orange.

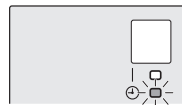

Display

**NOTE**

**In the following cases, set the timer again.**

- After the circuit breaker has turned off.
- After a power failure.
- After replacing the batteries in the remote controller.

**TIMER Operation**

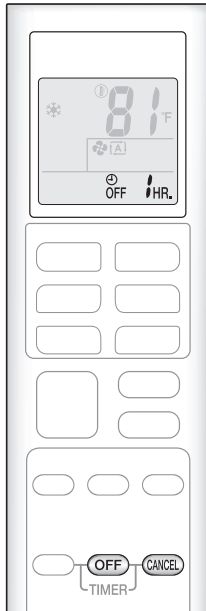

**To use OFF TIMER operation**

▶ Press **OFF** .

- Each pressing of **OFF** changes the time setting by 1 hour. The time can be set between 1 and 12 hours.
- The TIMER lamp lights orange.

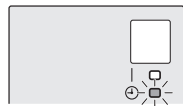

Display

**To cancel ON/OFF TIMER operation**

▶ Press **CANCEL** .

**To combine ON TIMER and OFF TIMER operation**

- A sample setting for combining the 2 timers is shown below.
- “ON” and “OFF” are displayed on the LCD.

**[Example]**



**When setting while the unit is operating**

- Stops the unit 1 hour later and starts it 7 hours after that.



**When setting while the unit is stopped**

- Starts the unit 2 hours later and stops it 3 hours after that.

**NOTE**

**NIGHT SET mode**

- When the OFF TIMER is set, the air conditioner automatically adjusts the temperature setting (0.9°F (0.5°C) up in COOL, 3.6°F (2.0°C) down in HEAT) to prevent excessive cooling (heating) during sleeping hours.



**Care**

# Care and Cleaning 09/12 class

## CAUTION

- Before cleaning, be sure to stop the operation and turn off the circuit breaker.
- Do not touch the aluminum fins of the indoor unit. If you touch those parts, this may cause an injury.

### ■ Quick reference

#### Cleaning parts

**Front panel**

- Wipe with a soft cloth which has been moistened with water or neutral detergent.
- Only neutral detergent may be used.

**If dirty**



**Air filter**

- Vacuum dust or wash the filter.

**Once every 2 weeks**

▶ Page 20

**Indoor unit, outdoor unit and remote controller**

- Wipe them with a soft cloth.

**If dirty**

**Titanium apatite deodorizing filter (without frame)**

- Vacuum dust or replace the filter.

<b>[Cleaning]</b>	<b>[Replacement]</b>
<b>Once every 6 months</b>	<b>Once every 3 years</b>
<small>▶ Page 21</small>	<small>▶ Page 21</small>

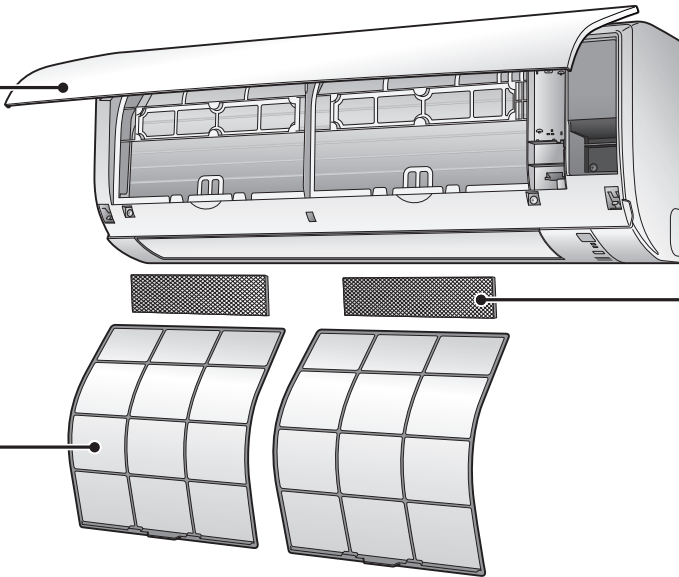

## NOTE

**For cleaning, do not use any of the following:**

- Water hotter than 104°F (40°C)
- Volatile liquid such as benzene, gasoline and thinner
- Polishing compounds
- Rough materials such as a scrubbing brush
- Sprays such as deodorizers



■ Air filter

**1. Open the front panel.**

- Hold the front panel by the sides and open it.

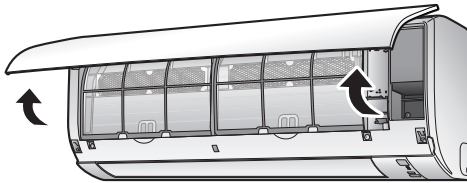

**2. Pull out the air filters.**

- Push the filter tab at the center of each air filter a little upwards, then pull it down.

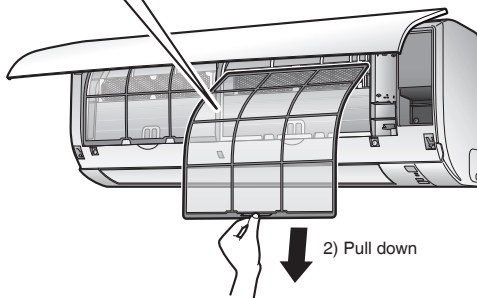
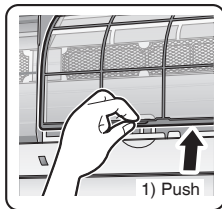

**3. Wash the air filters with water or clean them with vacuum cleaner.**

- It is recommended to clean the air filters every 2 weeks.

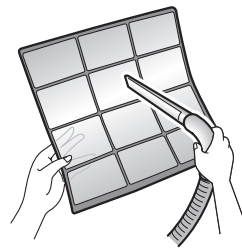

**If the dust does not come off easily**

- Wash the air filters with neutral detergent thinned with lukewarm water, then dry them up in the shade.



**4. Reattach the filters.**

**5. Close the front panel slowly.**

- Press the panel at both sides and the center.

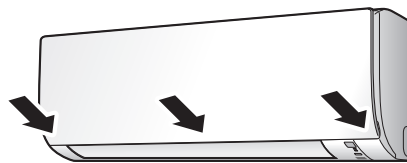

- Make sure that the front panel is securely fixed.

Care

# Care and Cleaning 09/12 class

## ■ Titanium apatite deodorizing filter

**1. Open the front panel and pull out the air filters.** ▶Page 20

**2. Take off the titanium apatite deodorizing filters.**

- Remove the filters from the tabs.

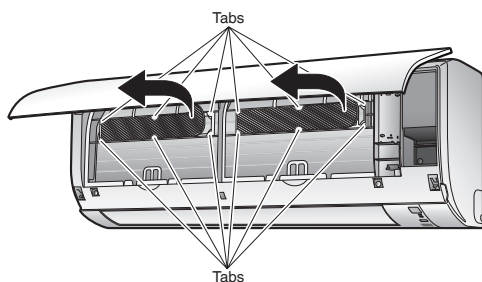

**3. Clean or replace the titanium apatite deodorizing filters.**

### [Cleaning]

**3-1 Vacuum dust, and soak in lukewarm water or water for about 10 to 15 minutes if very dirty.**



**3-2 After washing, shake off remaining water and let them dry in the shade.**

- Do not wring out the filter to remove water from it.

### [Replacement]

**Remove the filter from the tabs and prepare a new one.**

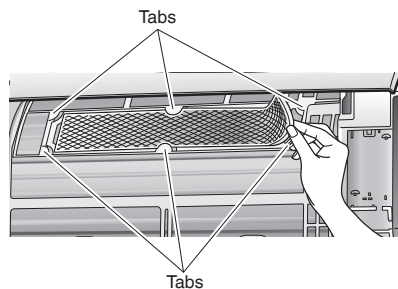

- Dispose of the old filter as non-flammable waste.

**4. Insert the titanium apatite deodorizing filters as they were.**

- When attaching the filter, check that the filter is properly set in the tabs.

**5. Reattach the filters.** ▶Page 20

**6. Close the front panel slowly.**

▶Page 20

### NOTE

- Operation with dirty filters:
  - cannot deodorize the air,
  - cannot clean the air,
  - results in poor heating or cooling,
  - may cause odor.
- Dispose of old filters as non-flammable waste.
- To order a titanium apatite deodorizing filter, contact the dealer where you bought the air conditioner.

Item	Titanium apatite deodorizing filter 1 set (2 pieces)
Part No.	KAF970A46 (without frame)

# Care and Cleaning 15 class

## CAUTION

- Before cleaning, be sure to stop the operation and turn off the circuit breaker.
- Do not touch the aluminum fins of the indoor unit. If you touch those parts, this may cause an injury.

### ■ Quick reference

#### Cleaning parts

##### Front panel

- Wipe with a soft cloth which has been moistened with water or neutral detergent.
- Only neutral detergent may be used.

**If dirty**



##### Air filter

- Vacuum dust or wash the filter.

**Once every 2 weeks**

▶ Page 23

##### Indoor unit, outdoor unit and remote controller

- Wipe them with a soft cloth.

**If dirty**

##### Titanium apatite deodorizing filter (with frame)

- Vacuum dust or replace the filter.

[Cleaning]

**Once every 6 months**

▶ Page 24

[Replacement]

**Once every 3 years**

▶ Page 24

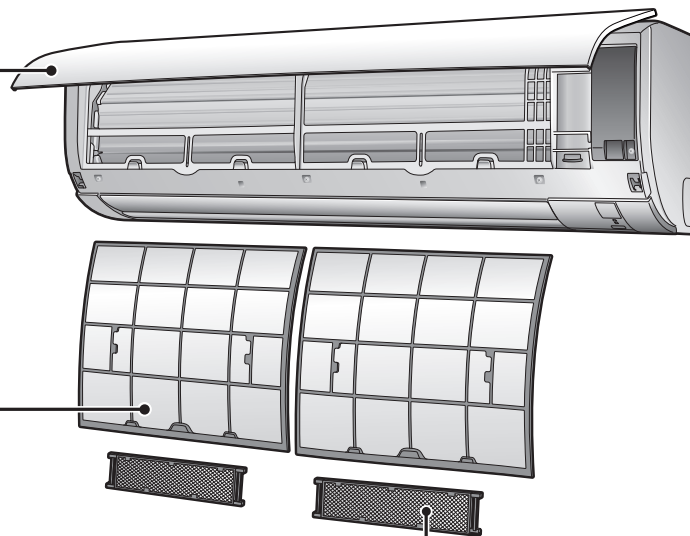

## NOTE

For cleaning, do not use any of the following:

- Water hotter than 104°F (40°C)
- Volatile liquid such as benzine, gasoline and thinner
- Polishing compounds
- Rough materials such as a scrubbing brush
- Sprays such as deodorizers



Care

# Care and Cleaning 15 class

## ■ Air filter

### 1. Open the front panel.

- Hold the front panel by the sides and open it.

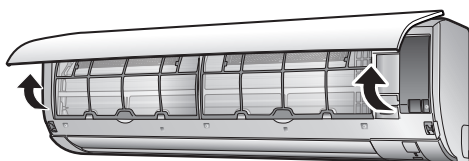

### 2. Pull out the air filters.

- Push the filter tab at the center of each air filter a little upwards, then pull it down.

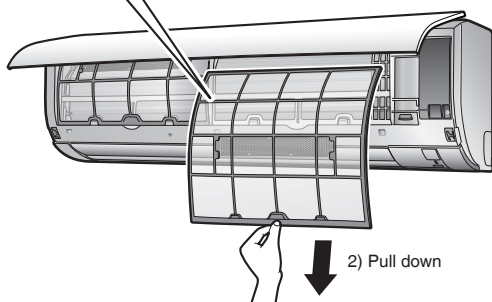
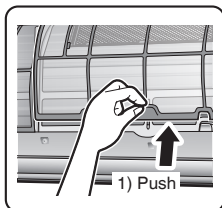

### 3. Wash the air filters with water or clean them with vacuum cleaner.

- It is recommended to clean the air filters every 2 weeks.

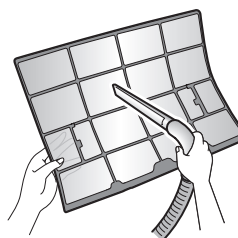

#### If the dust does not come off easily

- Wash the air filters with neutral detergent thinned with lukewarm water, then dry them up in the shade.
- Be sure to remove the titanium apatite deodorizing filter. Refer to "Titanium apatite deodorizing filter" on the next page.



### 4. Reattach the filters.

### 5. Close the front panel slowly.

- Press the front panel at both sides and in the central area.

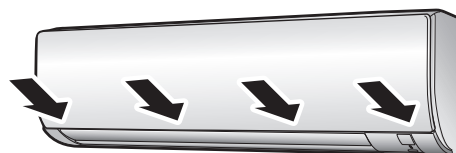

- Make sure that the front panel is securely fixed.

■ Titanium apatite deodorizing filter

**1. Open the front panel and pull out the air filters.** ▶ Page 23

**2. Take off the titanium apatite deodorizing filters.**

- Hold the recessed parts of the frame and unhook the 4 claws.
- Remove the filters from the tab.

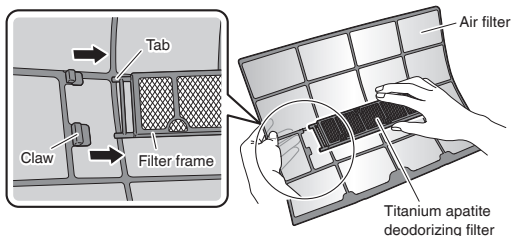

**3. Clean or replace the titanium apatite deodorizing filters.**

[Cleaning]

**3-1 Vacuum dust, and soak in lukewarm water or water for about 10 to 15 minutes if very dirty.**

- Do not remove the filter from the frame when washing with water.



**3-2 After washing, shake off remaining water and let them dry in the shade.**

- Do not wring out the filter to remove water from it.

[Replacement]

**Remove the filter from the filter frame and prepare a new one.**

- Do not throw away the filter frame. Reuse the filter frame when replacing the titanium apatite deodorizing filter.

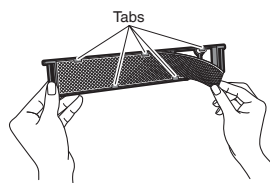

- Dispose of the old filter as non-flammable waste.

**4. Set the titanium apatite deodorizing filters as they were.**

- When attaching the filter, check that the filter is properly set in the tabs.

**5. Reattach the filters.** ▶ Page 23

**6. Close the front panel slowly.** ▶ Page 23

NOTE

- Operation with dirty filters:
  - cannot deodorize the air,
  - cannot clean the air,
  - results in poor heating or cooling,
  - may cause odor.
- Dispose of old filters as non-flammable waste.
- To order a titanium apatite deodorizing filter, contact the dealer where you bought the air conditioner.

Item	Titanium apatite deodorizing filter 1 set (2 pieces)
Part No.	KAF970A46 (without frame)
	KAF970A45 (with frame)

## Care

## Care and Cleaning All models

### ■ Prior to a long period of non-use

#### 1. Operate the FAN ONLY mode for several hours on a mild day to dry out the inside.

- Press **FAN ONLY**.

#### 2. After operation stops, turn off the circuit breaker for the room air conditioner.

#### 3. Clean the air filters and reattach them. ▶ Page 20, 23

#### 4. To prevent battery leakage, take out the batteries from the remote controller.

- When starting to use the air conditioner again, make sure that the drain hose outlet is not blocked, then turn on the circuit breaker.  
An operational check of each component will be carried out automatically. (Also, put the batteries into the remote controller.)

### ■ We recommend periodical maintenance

- In certain operating conditions, the inside of the air conditioner may get foul after several seasons of use, resulting in poor performance. It is recommended to have periodical maintenance by a qualified contractor in addition to regular cleaning by the user.
- For qualified contractor maintenance, please contact the dealer where you bought the air conditioner.

When the Need Arises

# FAQ

## Indoor unit

### The flaps do not start swinging immediately.

- The air conditioner is adjusting the position of the flaps. The flaps will start moving soon.

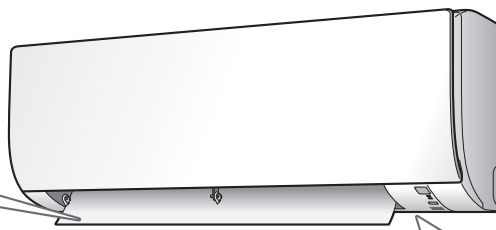

### The air conditioner stops generating airflow during HEAT operation.

- Once the set temperature is reached, the airflow rate is reduced and operation stopped in order to avoid generating a cool airflow. Operation will resume automatically when the indoor temperature falls.

### HEAT operation stops suddenly and a flowing sound is heard.

- The outdoor unit is defrosting. HEAT operation starts after the frost on the outdoor unit has been removed. This can take about 4 to 12 minutes.

### Operation does not start soon.

- **When the unit is turned on again soon after being turned off.**
- **When the mode was reselected.**
  - This is to protect the air conditioner. You should wait for about 3 minutes.

### Different sounds are heard.

- **A sound like flowing water**
  - This sound is generated because the refrigerant in the air conditioner is flowing.
  - This is a pumping sound of the water in the air conditioner and can be heard when the water is pumped out from the air conditioner during COOL or DRY operation.
- **Blowing sound**
  - This sound is generated when the flow of the refrigerant in the air conditioner is switched over.
  - If the outdoor temperature is low, this sound is generated when the direction of the flow of the refrigerant in the piping changes at the start of defrost operation, after HEAT operation is stopped and the room temperature is stabilized.
- **Ticking sound**
  - This sound is generated when the cabinet and frame of the air conditioner slightly expand or shrink as a result of temperature changes.
- **Whistling sound**
  - This sound is generated when refrigerant flows during defrosting operation.
- **Clicking sound during operation or idle time**
  - This sound is generated when the refrigerant control valves or the electrical parts operate.
- **Clopping sound**
  - This sound is heard from the inside of the air conditioner when the exhaust fan is activated while the room doors are closed. Open the window or turn off the exhaust fan.

## Outdoor unit

### Operating sound is loud.

- When frost forms on the heat exchanger of the outdoor unit, the operating sound level increases slightly.

### The outdoor unit emits water or steam.

- **In HEAT operation**
  - The frost on the outdoor unit melts into water or steam when the air conditioner is in defrosting operation.
- **In COOL or DRY operation**
  - Moisture in the air condenses into water on the cool surface of the outdoor unit piping and drips.

### Blowing sound

- If the outdoor temperature is low, this sound is generated when the direction of the flow of the refrigerant in the piping changes at the start of defrost operation, after HEAT operation is stopped and the room temperature is stabilized.

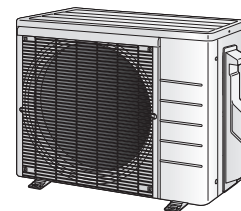



**When the Need Arises**

# Troubleshooting

Before making an inquiry or a request for repair, please check the following.  
If the problem persists, consult your dealer.



**Not a problem**

This case is not a problem.



**Check**

Please check again before requesting repairs.

**The air conditioner does not operate**

Case	Description / what to check
OPERATION lamp is off.	<ul style="list-style-type: none"> <li>Has the circuit breaker been tripped or the fuse blown?</li> <li>Is there a power failure?</li> <li>Are batteries set in the remote controller?</li> </ul>
OPERATION lamp is blinking.	<ul style="list-style-type: none"> <li>Turn off the power with the circuit breaker and restart operation with the remote controller.</li> </ul> If the OPERATION lamp is still blinking, check the error code and consult your dealer. <b>▶Page 31, 32</b>

**The air conditioner suddenly stops operating**

Case	Description / what to check
OPERATION lamp is on.	<ul style="list-style-type: none"> <li>To protect the system, the air conditioner may stop operating after sudden large voltage fluctuations. It automatically resumes operation in about 3 minutes.</li> </ul>
OPERATION lamp is blinking.	<ul style="list-style-type: none"> <li>Are the air filters dirty? Clean the air filters.</li> <li>Is there anything blocking the air inlet or air outlet of the indoor unit or outdoor unit? Stop operation and after turning off the circuit breaker, remove the obstruction. Then restart operation with the remote controller. If the OPERATION lamp is still blinking, check the error code and consult your dealer. <b>▶Page 31, 32</b></li> </ul>

**The air conditioner does not stop operating**

Case	Description / what to check
The air conditioner continues operating even after operation is stopped.	<ul style="list-style-type: none"> <li><b>Immediately after the air conditioner is stopped</b> <ul style="list-style-type: none"> <li>The outdoor unit fan continues rotating for about another 1 minute to protect the system.</li> </ul> </li> <li><b>While the air conditioner is not in operation</b> <ul style="list-style-type: none"> <li>When the outdoor temperature is high, the outdoor unit fan may start rotating to protect the system.</li> </ul> </li> </ul>

**The room does not cool down / warm up**

Case	Description / what to check
Air does not come out.	<ul style="list-style-type: none"> <li><b>In HEAT operation</b> <ul style="list-style-type: none"> <li>The air conditioner is warming up. Wait for about 1 to 4 minutes.</li> <li>During defrosting operation, hot air does not flow out of the indoor unit.</li> </ul> </li> <li><b>When the air conditioner operates immediately after the circuit breaker is turned on</b> <ul style="list-style-type: none"> <li>The air conditioner is preparing to operate. Wait for about 3 to 10 minutes.</li> </ul> </li> </ul>
Air does not come out / Air comes out.	<ul style="list-style-type: none"> <li><b>Is the airflow rate setting appropriate?</b> <ul style="list-style-type: none"> <li>Is the airflow rate setting low, such as "Indoor unit quiet" or "Airflow rate 1"? Increase the airflow rate setting.</li> </ul> </li> <li><b>Is the set temperature appropriate?</b></li> <li><b>Is the adjustment of the airflow direction appropriate?</b></li> </ul>

**When the Need Arises**

**The room does not cool down / warm up**

Case	Description / what to check
Air comes out.	<ul style="list-style-type: none"> <li><input type="checkbox"/> • Is there any furniture directly under or beside the indoor unit?</li> <li><input type="checkbox"/> • Is the air conditioner in ECONO operation? ▶ <b>Page 16</b></li> <li><input type="checkbox"/> • Are the air filters dirty?</li> <li><input type="checkbox"/> • Is there anything blocking the air inlet or air outlet of the indoor unit or outdoor unit?</li> <li><input type="checkbox"/> • Is a window or door open?</li> <li><input type="checkbox"/> • Is an exhaust fan turning?</li> <li><input type="checkbox"/> • Depending on the room conditions, number of occupants, or outdoor temperature and humidity, the set temperature may not be reached.</li> </ul>

**Water or mist comes out**

Case	Description / what to check
Mist comes out of the indoor unit.	<ul style="list-style-type: none"> <li><input checked="" type="checkbox"/> • This happens when the air in the room is cooled into mist by the cold airflow during COOL or other operation.</li> </ul>
Water is leaking from the indoor unit.	<ul style="list-style-type: none"> <li><input type="checkbox"/> • If the drain hose is crushed or clogged, water from the indoor unit may be unable to drain and start leaking. Stop operation of the unit immediately and contact your dealer.</li> </ul>

**Remote controller**

Case	Description / what to check
The unit does not receive signals from the remote controller or has a limited operating range.	<ul style="list-style-type: none"> <li><input checked="" type="checkbox"/> • The batteries may be exhausted. Replace both batteries with new dry batteries AAA.LR03 (alkaline). For details, refer to “<b>Preparation Before Operation</b>”. ▶ <b>Page 10</b></li> <li><input type="checkbox"/> • Signal communication may be disabled if an electronic-starter-type fluorescent lamp (such as inverter-type lamps) is in the room. Consult your dealer if that is the case.</li> <li><input type="checkbox"/> • The remote controller may not function correctly if the transmitter is exposed to direct sunlight.</li> <li><input type="checkbox"/> • Is there a device in the room that redirects remote controller signals? Some appliances such as TV speakers are equipped with these devices. If there is such a device in the room, the signals it emits may interfere with signals from the remote controller, preventing reception.</li> <li><input type="checkbox"/> • Infrared rays from smartphones and game consoles may interfere with signals from the remote controller, preventing reception.</li> </ul>
LCD is faint, is not working, or the display is erratic.	<ul style="list-style-type: none"> <li><input checked="" type="checkbox"/> • The batteries may be exhausted. Replace both batteries with new dry batteries AAA.LR03 (alkaline). For details, refer to “<b>Preparation Before Operation</b>”. ▶ <b>Page 10</b></li> </ul>
Other electric devices start operating.	<ul style="list-style-type: none"> <li><input checked="" type="checkbox"/> • If the remote controller activates other electric devices, move them away or consult your dealer.</li> </ul>

**Air has an odor**

Case	Description / what to check
The air conditioner gives off an odor.	<ul style="list-style-type: none"> <li><input checked="" type="checkbox"/> • The room odor absorbed in the unit is discharged with the airflow. We recommend you to have the indoor unit cleaned. Please consult your dealer.</li> </ul>
	<ul style="list-style-type: none"> <li><input checked="" type="checkbox"/> • The indoor unit is blowing out room odor it has absorbed (the smell of walls or carpeting, furniture, clothes, and so on). If the air conditioner has been used for a long time, there is a chance that a dirty heat exchanger or fan are emitting an odor. We recommend you to have the indoor unit cleaned. Please consult your dealer. Do not spray the air conditioner unit with any deodorizers.</li> </ul>

**When the Need Arises**

# Troubleshooting

## Others

Case	Description / what to check
The air conditioner suddenly starts behaving strangely during operation.	<input type="checkbox"/> • The air conditioner may malfunction due to lightning or radio. If the air conditioner malfunctions, turn off the power with the circuit breaker and restart the operation with the remote controller.
The ceiling and walls around the indoor unit are black and dirty.	<input checked="" type="checkbox"/> • Due to the circulation pattern of the air and static electricity, the air conditioner is causing airborne dirt and dust to stick to walls and other surfaces. Depending on the wallpaper type, dirt may adhere more easily. A thorough cleaning of the area around the air conditioner is recommended.

### Notes on the operating conditions

- If operation continues under any conditions other than those listed in the table,
  - A safety device may activate to stop the operation.
  - Dew may form on the indoor unit and drip from it when COOL or DRY operation is selected.
- \*1 Cutting the jumper on the outdoor unit PCB will extend the cooling operation range to 14°F (–10°C).  
 Installing an air direction adjustment grille (sold separately) will further extend the operation range to –4°F (–20°C).  
 Please consult your dealer.
- \*2 Installing a drain pan heater (sold separately) will further extend the heating operation range to –13°F (–25°C).  
 Please consult your dealer.

Mode	Operating conditions
COOL / DRY	Outdoor temperature : 50*1 - 115°F (10*1 - 46°C) *1 –4°F (–20°C) if an air direction adjustment grille (sold separately) is installed. Indoor temperature : 64 - 90°F (18 - 32°C) Indoor humidity : 80% max.
HEAT	Outdoor temperature : 5*2 - 75°F (–15*2 - 24°C) *2 –13°F (–25°C) if a drain pan heater (sold separately) is installed. Indoor temperature : 50 - 86°F (10 - 30°C)

**When the Need Arises**

**■ Call your dealer immediately**

 **WARNING**

**When an abnormality (such as a burning smell) occurs, stop operation and turn off the circuit breaker.**

- Continued operation in an abnormal condition may result in problems, electric shock or fire.
- Consult the dealer where you bought the air conditioner.

**Do not attempt to repair or modify the air conditioner by yourself.**

- Incorrect work may result in electric shock or fire.
- Consult the dealer where you bought the air conditioner.

**If one of the following symptoms takes place, call your dealer immediately.**

- The power cord is abnormally hot or damaged.
- An abnormal sound is heard during operation.
- The circuit breaker cuts off the operation frequently.
- A switch or a button often fails to work properly.
- There is a burning smell.
- Water leaks from the indoor unit.

Turn off the circuit breaker and call your dealer. 

- **After a power failure**
  - The air conditioner automatically resumes operation in about 3 minutes. Please wait for a while.
- **Lightning**
  - If there is a risk lightning could strike in the neighborhood, stop operation and turn off the circuit breaker to protect the system.

**■ Disposal requirements**

- Dismantling of the unit, handling of the refrigerant, oil and other parts, should be done in accordance with the relevant local and national regulations.

**When the Need Arises**

# Troubleshooting

## The OPERATION lamp blinks

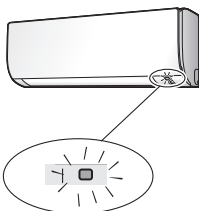

■ Check the interval time between blinks of the OPERATION lamp.

[Blink interval of about 0.5 seconds]  
 This is a notification of an abnormality.  
 Check the error code following the procedure below, and respond according to the instructions in the table.



■ Fault diagnosis by remote controller

1. When **CANCEL** is held down for about 5 seconds, “00” blinks in the temperature display section.
2. While pointing the remote controller at the indoor unit, press **CANCEL** repeatedly.  
 A beep indicates a non-corresponding error code.  
 A long beep indicates a corresponding error code.
3. When a long beep is produced, check the error code and respond according to the instructions in the table.
  - To cancel the code display, hold down **CANCEL** for about 5 seconds (the code display also clears if no button is pressed for a while).

CODE	Cause	Description / what to check
E7	The fan of the outdoor unit is stopped. • Is there any foreign matter inside the outdoor unit?	After turning off the circuit breaker, remove the foreign matter, then turn the power on again and operate.
L3, L4, L5	The temperature inside the outdoor unit has become too high, so operation has stopped. • Is there anything blocking the air outlet of the outdoor unit?	After turning off the circuit breaker, remove the obstruction, then turn the power on again and operate.
Other error codes, or if the error code cannot be checked		An abnormality has occurred.

In the case of error code U0 or F3

When the Need Arises

	CODE	MEANING
SYSTEM	00	NORMAL
	UA	INDOOR-OUTDOOR UNIT COMBINATION FAULT
	U0	REFRIGERANT SHORTAGE
	U2	DROP VOLTAGE OR MAIN CIRCUIT OVERVOLTAGE
	U4	FAILURE OF TRANSMISSION (BETWEEN INDOOR UNIT AND OUTDOOR UNIT)
INDOOR UNIT	A1	INDOOR PCB DEFECTIVENESS
	A5	HIGH PRESSURE CONTROL OR FREEZE-UP PROTECTOR
	A6	FAN MOTOR FAULT
	C4	FAULTY HEAT EXCHANGER TEMPERATURE SENSOR
	C9	FAULTY SUCTION AIR TEMPERATURE SENSOR
OUTDOOR UNIT	EA	COOLING-HEATING SWITCHING ERROR
	E1	CIRCUIT BOARD FAULT
	E3*	HIGH PRESSURE SWITCH (HPS) ACTIVATED
	E5	OL (COMPRESSOR OVERLOAD) STARTED, HIGH PRESSURE SWITCH (HPS) ACTIVATED*
	E6	FAULTY COMPRESSOR START UP
	E7	DC FAN MOTOR FAULT
	E8	OVERCURRENT INPUT
	F3	HIGH TEMPERATURE DISCHARGE PIPE CONTROL
	F6	HIGH PRESSURE CONTROL (IN COOLING)
	H0	SENSOR FAULT
	H6	OPERATION HALT DUE TO FAULTY POSITION DETECTION SENSOR
	H8	DC CURRENT SENSOR FAULT
	H9	FAULTY SUCTION AIR TEMPERATURE SENSOR
	J3	FAULTY DISCHARGE PIPE TEMPERATURE SENSOR
	J6	FAULTY HEAT EXCHANGER TEMPERATURE SENSOR
	L3	ELECTRICAL PARTS HEAT FAULT
	L4	HIGH TEMPERATURE AT INVERTER CIRCUIT HEATSINK
L5	OUTPUT OVERCURRENT	
P4	FAULTY INVERTER CIRCUIT HEATSINK TEMPERATURE SENSOR	

\*The contents of the error differ depending on the connected outdoor unit.

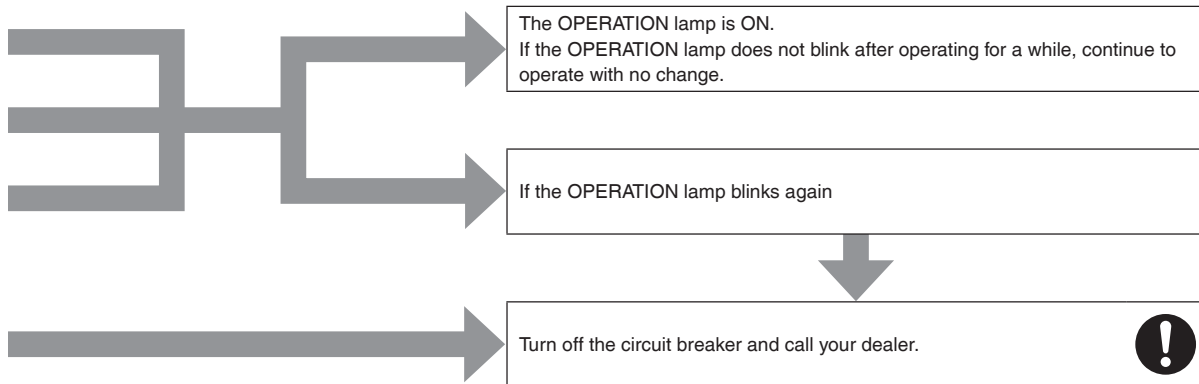

## 13.2 FTX18/24

### Read Before Operation

# Safety Considerations

Refer also to the General Safety Considerations in the separate booklet.



**Read the precautions in this manual carefully before operating the unit.**

Read these **Safety Considerations for Operations** carefully before operating an air conditioner or heat pump.

Make sure that the unit operates properly during the startup operation. Instruct the user on how to operate and maintain the unit.

Inform users that they should store this operation manual with the installation manual for future reference.

Meanings of **DANGER**, **WARNING**, **CAUTION**, and **NOTE** Symbols:

**⚠ DANGER** ..... Indicates an imminently hazardous situation which, if not avoided, will result in death or serious injury.

**⚠ WARNING** ..... Indicates a potentially hazardous situation which, if not avoided, could result in death or serious injury.

**⚠ CAUTION** ..... Indicates a potentially hazardous situation which, if not avoided, may result in minor or moderate injury. It may also be used to alert against unsafe practices.

**⚠ NOTE** ..... Indicates situations that may result in equipment or property damage accidents only.

#### ⚠ DANGER

- Do not install the unit in an area where flammable materials are present due to risk of explosion resulting in serious injury or death.
- Any abnormalities in the operation of the air conditioner or heat pump, such as smoke or fire, could result in severe injury or death. Turn off the power and contact your dealer immediately.
- Refrigerant gas may produce toxic gas if it comes into contact with fire, such as from a fan heater, stove, or cooking device. Exposure to this gas could cause severe injury or death.
- For refrigerant leakage, consult your dealer. Refrigerant gas is heavier than air and replaces oxygen. A massive leak could lead to oxygen depletion, especially in basements, and an asphyxiation hazard could occur leading to serious injury or death.
- If equipment utilizing a burner is used in the same room as the air conditioner or heat pump, there is the danger of oxygen deficiency which could lead to an asphyxiation hazard resulting in serious injury or death. Be sure to ventilate the room sufficiently to avoid this hazard.
- Safely dispose of the packing materials. Packing materials, such as nails and other metal or wooden parts, may cause stabs or other injuries.
- Tear apart and throw away plastic packaging bags so that children will not play with them. Children playing with plastic bags face the danger of death by suffocation.

#### ⚠ WARNING

- Contact your dealer for repair and maintenance. Improper repair and maintenance may result in water leakage, electric shock, and fire. Only use accessories made by Daikin that are specifically designed for use with the equipment and have them installed by a professional.
- Contact your dealer to move and reinstall the air conditioner or heat pump. Incomplete installation may result in water leakage, electric shock, and fire.
- Never let the indoor unit or the remote controller get wet. Water can cause an electric shock or a fire.
- Never use flammable spray such as hair spray, lacquer, or paint near the unit. Flammable spray may cause a fire.
- When a fuse blows out, never replace it with one of incorrect ampere ratings or different wires. Always replace any blown fuse with a fuse of the same specification.
- Never remove the fan guard of the unit. A fan rotating at high speed without the fan guard is very dangerous.
- Never inspect or service the unit by yourself. Contact a qualified service person to perform this work.
- Turn off all electrical power before doing any maintenance to avoid the risk of serious electric shock; never sprinkle or spill water or liquids on the unit.
- Do not touch the switch with wet fingers. Touching a switch with wet fingers can cause electric shock.
- Do not allow children to play on or around the unit to prevent injury.
- The heat exchanger fins are sharp enough to cut. To avoid injury wear gloves or cover the fins while working around them.
- Do not put a finger or other objects into the air inlet or air outlet. The fan is rotating at high speed and will cause injury.
- Check the unit foundation for damage on a continuous basis, especially if it has been in use for a long time. If left in a damaged condition the unit may fall and cause injury.
- Placing a flower vase or other containers with water or other liquids on the unit could cause a shock or fire if a spill occurs.
- Do not touch the air outlet or horizontal blades while the swing flap is in operation because fingers could get caught and injured.
- Never touch the internal parts of the controller. Do not remove the front panel because some parts inside are dangerous to touch. To check and adjust internal parts, contact your dealer.
- Do not use means to accelerate the defrosting process or to clean, other than those recommended by the manufacturer.
- The appliance must be stored in a room without continuously operating ignition sources (for example: open flames, an operating gas appliance or an operating electric heater).
- Do not pierce or burn.
- Be aware that refrigerants may not contain an odor.

**Read Before Operation**

**⚠ CAUTION**

- Do not use the air conditioner or heat pump for any other purposes other than comfort cooling or heating. Do not use the unit for cooling precision instruments, food, plants, animals or works of art.
- Do not place items under the indoor unit as they may be damaged by condensates that may form if the humidity is above 80% or if the drain outlet gets blocked.
- Before cleaning, stop the operation of the unit by turning the power off or by pulling the supply cord out from its receptacle. Otherwise, an electric shock and injury may result.
- Do not wash the air conditioner or heat pump with excessive water. An electric shock or fire may result.
- Avoid placing the controller in a spot which may be splashed with water. Water entering the controller may cause an electric shock or damage the internal electronic parts.
- Do not operate the air conditioner or heat pump when using a room-fumigation type of insecticide. Failure to observe this could cause the chemicals to be deposited in the unit and can endanger the health of those who are hypersensitive to chemicals.
- Do not turn off the power immediately after stopping operation. Always wait for at least 5 minutes before turning off the power. Otherwise, water leakage may occur.
- The appliance is not intended for use by young children or infirm persons without supervision.
- The remote controller should be kept away from children so they cannot play with it.
- Consult with the installation contractor for cleaning.
- Incorrect cleaning of the inside of the air conditioner or heat pump could make the plastics parts break and cause water leakage or electric shock.
- Do not touch the air inlet or aluminum fin of the air conditioner or heat pump as they can cut and cause injury.
- Do not place objects in direct proximity of the outdoor unit. Do not let leaves and other debris accumulate around the unit. Leaves are a hotbed for small animals which can enter the unit. Once inside the unit, animals can cause the unit to malfunction, and cause smoke or fire when they make contact with electrical parts.

**⚠ NOTE**

- Never press the button of the remote controller with a hard, pointed object. The remote controller may be damaged.
- Never pull or twist the electric wire of the remote controller. It may cause the unit to malfunction.
- Do not place appliances that produce open flames in places that are exposed to the airflow of the unit or under the indoor unit. It may cause incomplete combustion or deformation of the unit due to the heat.
- Do not expose the controller to direct sunlight. The LCD display can become discolored and may fail to display the data.

- Do not wipe the controller operation panel with benzine, thinner, chemical dust cloth, etc. The panel may get discolored or the coating can peel off. If it is heavily dirty, soak a cloth in water-diluted neutral detergent, squeeze it well and wipe the panel clean. Then wipe it with another dry cloth.
- Dismantling of the unit, disposal of the refrigerant, oil, and additional parts, should be done in accordance with the relevant local, state, and national regulations.
- Operate the air conditioner or heat pump in a sufficiently ventilated area and not surrounded by obstacles. Do not use the air conditioner or heat pump in the following places.
  - a. Places with a mist of mineral oil, such as cutting oil.
  - b. Locations such as coastal areas where there is a lot of salt in the air.
  - c. Locations such as hot springs where there is a lot of sulfur in the air.
  - d. Locations such as factories where the power voltage varies a lot.
  - e. In cars, boats, and other vehicles.
  - f. Locations such as kitchens where oil may splatter or where there is steam in the air.
  - g. Locations where equipment produces electromagnetic waves.
  - h. Places with an acid or alkaline mist.
  - i. Places where fallen leaves can accumulate or where weeds can grow.
- Take snow protection measures. Contact your dealer for the details of snow protection measures, such as the use of a snow protection hood.
- Do not attempt to do electrical work or grounding work unless you are licensed to do so. Consult with your dealer for electrical work and grounding work.
- Pay attention to operating sound. Be sure to use the following places:
  - a. Places that can sufficiently withstand the weight of the air conditioner or heat pump yet can suppress the operating sound and vibration.
  - b. Places where warm air from the air outlet of the outdoor unit or the operating sound of the outdoor unit does not annoy neighbors.
- Make sure that there are no obstacles close to the outdoor unit. Obstacles close to the outdoor unit may drop the performance of the outdoor unit or increase the operating sound of the outdoor unit.
- Consult your dealer if the air conditioner or heat pump in operation generates unusual noise.
- Make sure that the drainpipe is installed properly to drain water. If no water is discharged from the drainpipe while the air conditioner or heat pump is in the cooling mode, the drainpipe may be clogged with dust or dirt and water leakage from the indoor unit may occur. Stop operating the air conditioner or heat pump and contact your dealer.
- Do not spray the air conditioner unit with any deodorizers, etc. It may cause the unit to malfunction.

FTP002M-U



**Read Before Operation**

# Names of Parts

## Indoor Unit

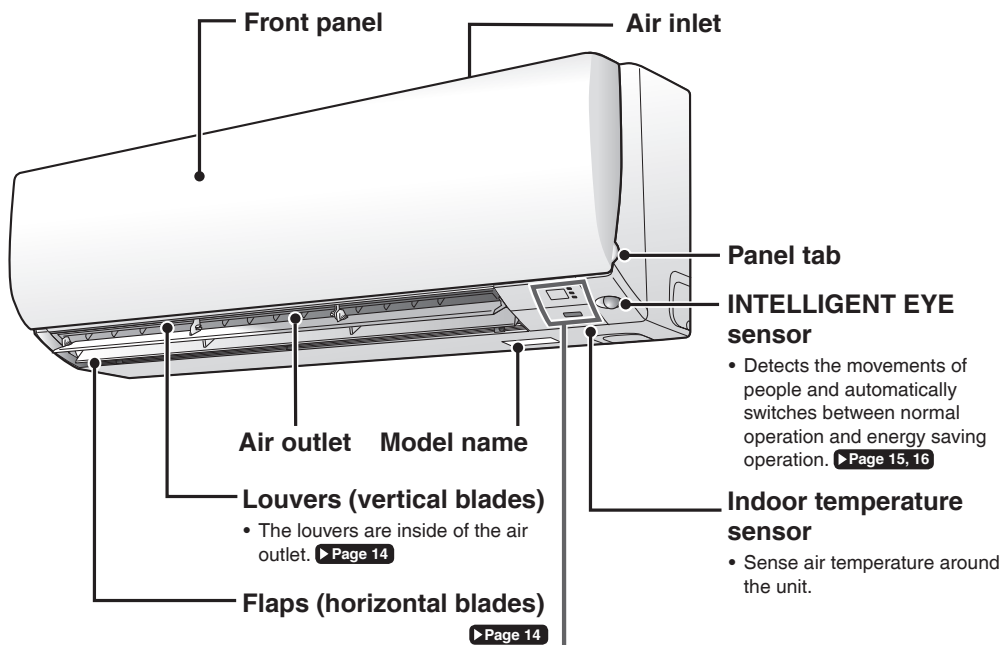

### Display

**Signal receiver**

- Receives signals from the remote controller.
- When the unit receives a signal, you will hear a beep sound.

Case	Sound type
Operation start	beep-beep
Setting changed	beep
Operation stop	long beep

**OPERATION lamp (green)**

**TIMER lamp (orange)**

▶ Page 19, 20, 23

**INTELLIGENT EYE lamp (green)**

▶ Page 15

**Indoor unit ON/OFF switch**

- Press this switch once to start operation. Press once again to stop it.
- For the operation mode setting, refer to the following table.

Mode	Temperature setting	Airflow rate
AUTO	77°F (25°C)	AUTO

- This switch can be used when the remote controller is missing or out of batteries.

**Read Before Operation**

■ **Open the front panel**

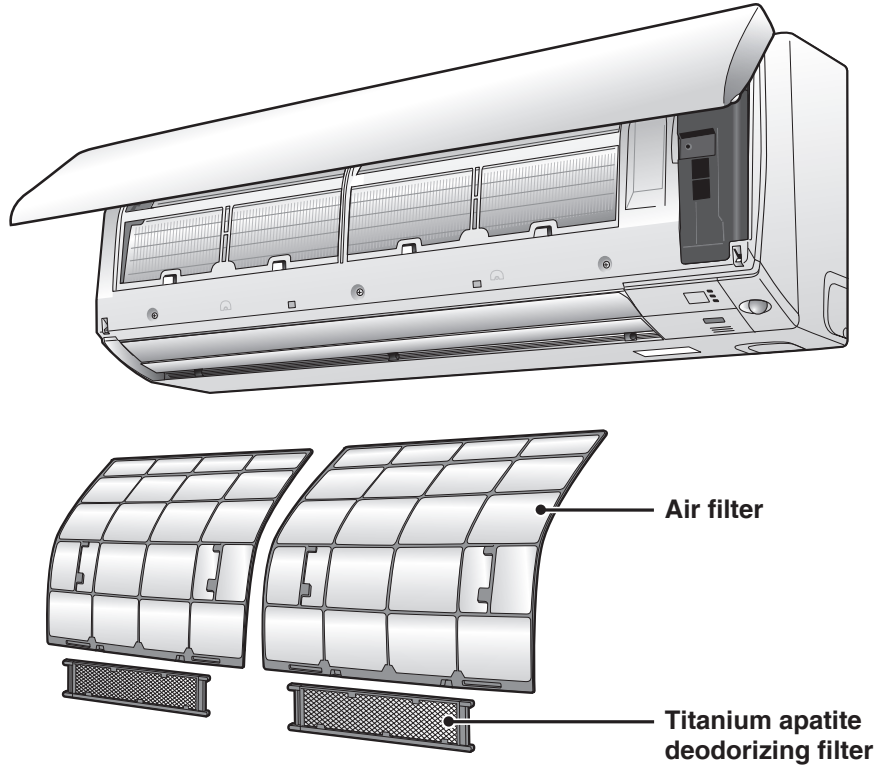

**Outdoor Unit**

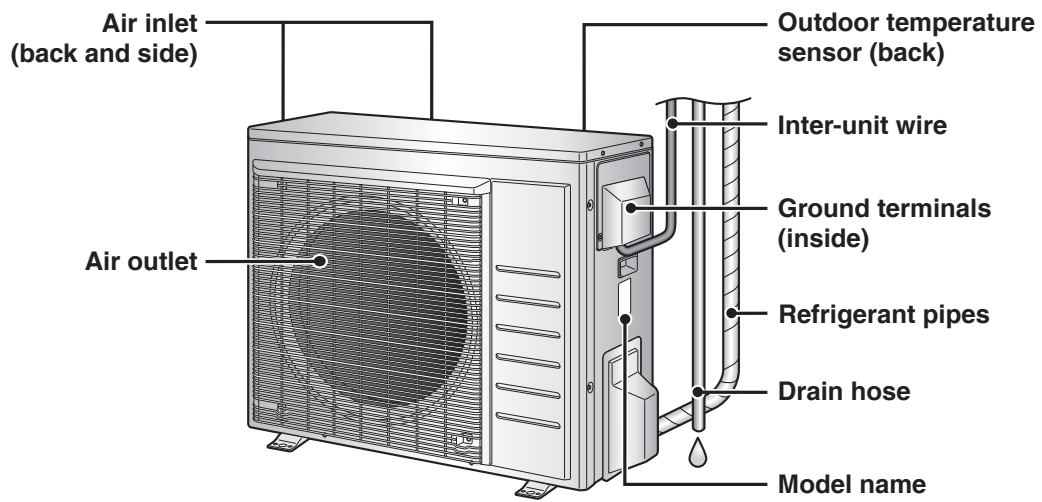

**Read Before Operation**

# Names of Parts

## Remote Controller

**Signal transmitter**

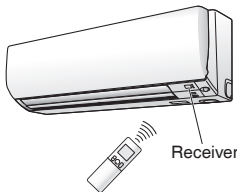

Receiver

- To use the remote controller, aim the transmitter at the indoor unit. If there is anything blocking the signals between the unit and the remote controller, such as a curtain, the unit may not operate.
- The maximum transmission distance is about 23ft (7m).

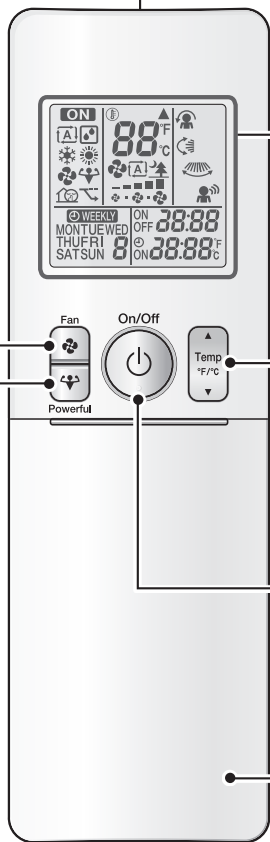

**Display (LCD)**

- Displays the current settings. (In this illustration, each section is shown with all its displays on for the purpose of explanation.)

**TEMPERATURE adjustment button**

- Changes the temperature setting. [▶ Page 12](#)

**ON/OFF button**

- Press this button once to start operation. Press once again to stop it. [▶ Page 11](#)

**Front cover**

- Open the front cover. [▶ Page 8](#)

**FAN setting button**

- Selects the airflow rate setting. [▶ Page 13](#)

**POWERFUL button**

- POWERFUL operation. [▶ Page 17](#)

Model	ARC466A37
-------	-----------

**Read Before Operation**

■ **Open the front cover**

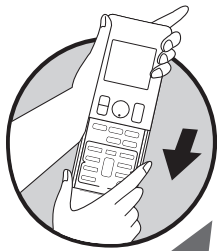

**MODE selector button**

- Selects the operation mode. (AUTO/DRY/COOL/HEAT/FAN) ▶ [Page 11](#)

**COMFORT/SENSOR button**

- COMFORT AIRFLOW / INTELLIGENT EYE operation. ▶ [Page 15](#)

**ECONO/QUIET button**

- ECONO/QUIET OUTDOOR UNIT operation. ▶ [Page 18](#)

**SWING button**

- Adjusts the airflow direction. ▶ [Page 14](#)

**OFF TIMER button (NIGHT SET mode)**

▶ [Page 20](#)

**TIMER CANCEL button**

- Cancels the timer setting. ▶ [Page 19, 20](#)
- Cannot be used for the WEEKLY TIMER operation.

Weekly

◀ : WEEKLY button

◊ : PROGRAM button

Copy

▶ : COPY button

Back

◀ : BACK button

Next

▶ : NEXT button

- WEEKLY TIMER operation. ▶ [Page 21](#)

**ON TIMER button**

▶ [Page 19](#)

**SELECT button**

- Changes the clock, ON/OFF TIMER and WEEKLY TIMER settings.

**CLOCK button** ▶ [Page 10](#)

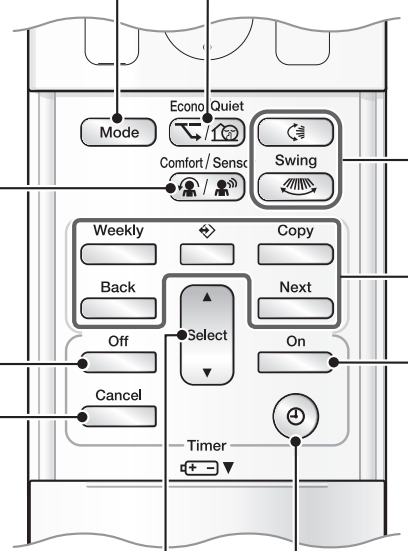

**Read Before Operation**

# Preparation Before Operation

## CAUTION

**Incorrect handling of batteries can result in injury from battery leakage, rupturing or heating, or lead to equipment failure. Please observe the following precautions and use safely.**

- If the alkaline solution from the batteries should get in the eyes, do not rub the eyes. Instead, immediately flush the eyes with tap water and seek the attention of a medical professional.
- Keep batteries out of reach of children. In the event that batteries are swallowed, seek the immediate attention of a medical professional.
- Do not expose batteries to heat or fire. Do not disassemble or modify batteries. The insulation or gas release vent inside the battery may be damaged, resulting in battery leakage, rupturing, or heating.
- Do not damage or peel off labels on the batteries.

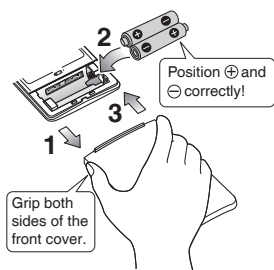

### To insert the batteries

- 1. Slide the front cover to take it off.**
- 2. Insert 2 dry batteries AAA.LR03 (alkaline).**
- 3. Replace the front cover.**

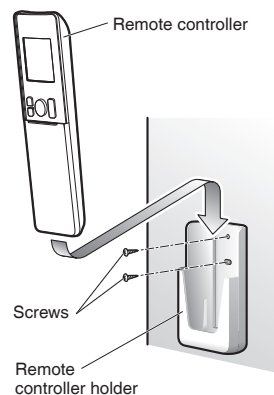

### To attach the remote controller holder to a wall

- 1. Choose a place where the signals reach the unit.**
- 2. Attach the holder to a wall, a pillar, or similar location with the screws supplied with the holder.**
- 3. Place the remote controller in the remote controller holder.**

### Fahrenheit/Celsius display switch

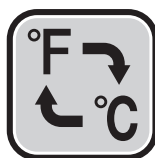

Press  and  (TIMER button)

**simultaneously for about 5 seconds.**

- The temperature will be displayed in Celsius when it is presently displayed in Fahrenheit, and vice versa.
- The switch operation is only possible when the temperature is being displayed.
- A reception sound will go off for the transmission of set temperature to the indoor unit at the time of setting the Fahrenheit/Celsius display change function.

## NOTE

### Notes on batteries

- To avoid possible injury or damage from battery leakage or rupturing, remove the batteries when not using the product for long periods of time.
- The standard replacement time is about 1 year. Both batteries should be replaced at the same time. Be sure to replace them with new dry batteries AAA.LR03 (alkaline).
- If the remote controller display begins to fade and signal reception begins to decline, replace the batteries with new batteries. Owing to usage conditions, battery consumption may be accelerated.
- The batteries supplied with the remote controller are for initial operation. The batteries may run out in less than 1 year.

### Notes on remote controller

- Do not drop the remote controller. Do not get it wet.
- If dirt becomes an issue, wipe with a soft dry cloth.

**Read Before Operation**

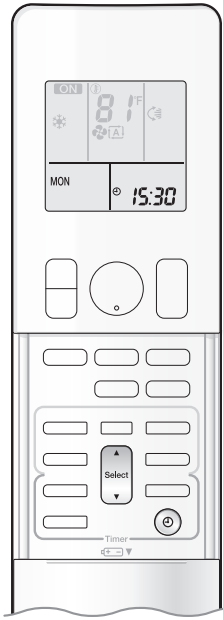

**Turn on the circuit breaker**

- After the power is turned on, the flaps of the indoor unit open and close once to set the reference position.

**To set the clock**

**1. Press**  .



“0:00” is displayed on the LCD.  
“MON” and “” blink.

**2. Press**  to set the current day of the week.

Display	Day of the week
MON	Monday
TUE	Tuesday
WED	Wednesday
THU	Thursday
FRI	Friday
SAT	Saturday
SUN	Sunday

**3. Press**  .



“” blinks.

**4. Press**  to set the clock to the present time.

- Holding down  or  rapidly increases or decreases the displayed time.

**5. Press**  .

- Point the remote controller at the indoor unit when pressing the buttons.



“.” blinks.

**NOTE**

**Fahrenheit/Celsius display change function of remote controller**

- The set temperature may increase when the display is changed to Celsius from Fahrenheit, because a fraction of 0.5°C is rounded up.
- Example: A set temperature of 65°F (equivalent to 18.5°C) will be converted into 19°C.  
When the display is changed to Fahrenheit again, the set temperature will be converted into 66°F (equivalent to 19°C) instead of the original set temperature (65°F) but a set temperature of 66°F (equivalent to 19°C) will be converted into 19°C with no temperature change.

**Note on setting the clock**

- If the indoor unit's internal clock is not set to the correct time, the ON/OFF TIMER and WEEKLY TIMER will not operate punctually.

**Basic Operation**



# AUTO · DRY · COOL · HEAT · FAN Operation

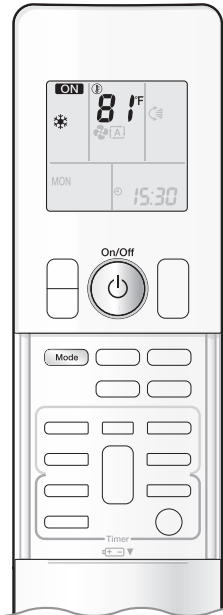

The air conditioner operates with the operation mode of your choice. From the next time on, the air conditioner will operate with the same operation mode.

**To start operation**

**1. Press  and select an operation mode.**

- Each pressing of the button changes the mode setting in sequence.

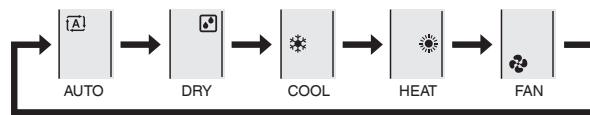

**2. Press .**

- “**ON**” is displayed on the LCD.
- The OPERATION lamp lights green.



Display

**To stop operation**

**Press  again.**

- “**ON**” disappears from the LCD.
- The OPERATION lamp goes off.

**NOTE**

**Notes on AUTO operation**

- In AUTO operation, the system selects an appropriate operation mode (COOL or HEAT) based on the indoor temperature and starts the operation.
- The system automatically reselects setting at a regular interval to bring the indoor temperature to the user-setting level.

**Note on DRY operation**

- Eliminates humidity while maintaining the indoor temperature as much as possible. It automatically controls temperature and airflow rate, so manual adjustment of these functions is unavailable.

Basic Operation

To change the temperature setting

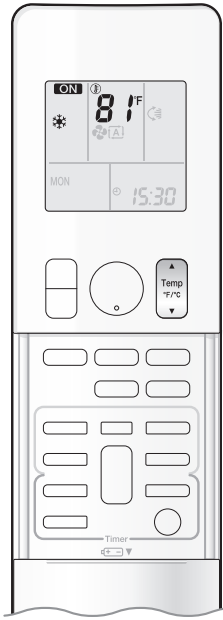

Press  .

- Press ▲ to raise the temperature and press ▼ to lower the temperature.

COOL operation	HEAT operation	AUTO operation	DRY or FAN operation
64-90°F (18-32°C)	50-86°F (10-30°C)	64-86°F (18-30°C)	The temperature setting cannot be changed.

Tips for saving energy

Keeping the temperature setting at a moderate level helps save energy.

- Recommended temperature setting
  - For cooling: 78-82°F (26-28°C)
  - For heating: 68-75°F (20-24°C)

Cover windows with a blind or a curtain.

- Blocking sunlight and air from outdoors increases the cooling (heating) effect.

Keep the air filters clean.

- Clogged air filters cause inefficient operation and waste energy. Clean them once in about every 2 weeks. [▶ Page 29](#)

If you are not going to use the air conditioner for a long period, for example in spring or autumn, turn off the circuit breaker.

- The air conditioner always consumes a small amount of electricity even while it is not operating.





**Basic Operation**



# Adjusting the Airflow Rate



You can adjust the airflow rate to increase your comfort.

**To adjust the airflow rate setting**

Press .

- Each pressing of changes the airflow rate setting in sequence.

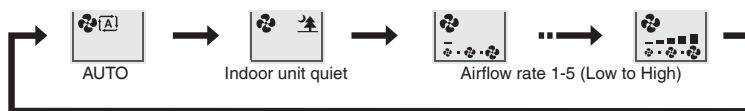

- When the airflow is set to “”, quiet operation starts and noise from the indoor unit will become quieter.
- In the quiet operation mode, the airflow rate is set to a weak level.

AUTO, COOL, HEAT and FAN operation			DRY operation
			The airflow rate setting cannot be changed.

**NOTE**

**Note on airflow rate setting**

- At smaller airflow rates, the cooling (heating) effect is also smaller.

**Note on AUTO airflow rate**

- When using AUTO airflow rate, the airflow rate is adjusted according to conditions in the room.



## Adjusting the Airflow Direction

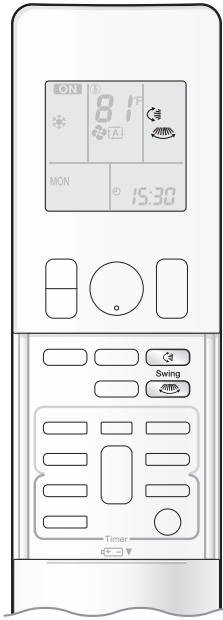

You can adjust the airflow direction to increase your comfort.

### CAUTION

- Always use a remote controller to adjust the angles of the flaps and louvers.
  - If you attempt to move the flaps and louvers forcibly by hand when they are swinging, the mechanism may be damaged.
  - Inside the air outlet, a fan is rotating at a high speed.

### To start auto swing

#### Up and down airflow direction

Press .

- “” is displayed on the LCD.
- The flaps (horizontal blades) will begin to swing.

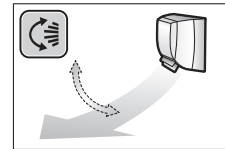

#### Right and left airflow direction



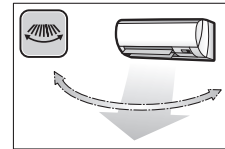

Press .

- “” is displayed on the LCD.
- The louvers (vertical blades) will begin to swing.



#### The 3-D airflow direction

Press  and .

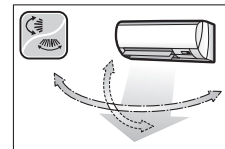

- “” and “” are displayed on the LCD.
- The flaps and louvers move in turn.
- To cancel 3-D airflow, press either  or  again. The flaps or louvers will stop moving.



### To set the flaps or louvers at the desired position

- This function is effective while the flaps or louvers are in auto swing mode.

Press  and  when the flaps or louvers reach the desired position.

- In the 3-D airflow, the flaps and louvers move in turn.
- “” or “” disappears from the LCD.

### NOTE

#### Notes on airflow direction setting

- The movable range of the flaps varies according to the operation mode.
- If the airflow rate becomes weak during operation, the flaps and louvers will stop. When up and down airflow direction is set, the flaps will stop in an upward position.
- When the airflow rate setting is low, or when 3-D airflow direction is set, the room temperature may not reach the set temperature (for example, if the air conditioner is blowing air toward the wall). In that case, change the airflow direction or the airflow rate.

#### Note on 3-D airflow

- Using 3-D airflow circulates cold air, which tends to be collected at the bottom of the room, and hot air, which tends to collect near the ceiling, throughout the room, preventing areas of cold and hot developing.

Movable range of the flaps

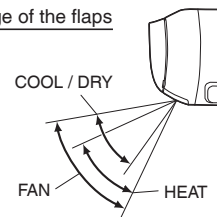

**Useful Functions**



# COMFORT AIRFLOW / INTELLIGENT EYE Operation

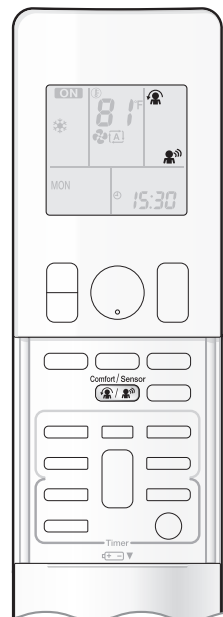

**COMFORT AIRFLOW operation:**

The flow of air will be in the upward direction while in COOL and DRY operation and in the downward direction while in HEAT operation, which will provide a comfortable airflow that will not come in direct contact with people.

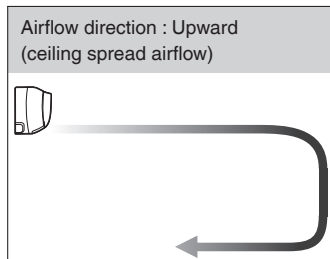

COOL and DRY operation

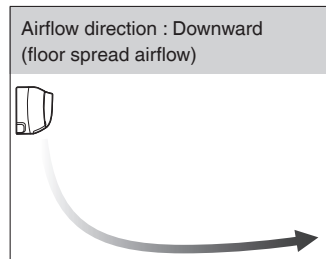

HEAT operation

**INTELLIGENT EYE operation:** The INTELLIGENT EYE sensor detects human movement. If no one is in the room for more than 20 minutes, the operation automatically changes to energy saving operation.

**CAUTION**

- Do not place large objects near the INTELLIGENT EYE sensor. Also keep heating units and humidifiers outside the sensor's detection area. This sensor can detect undesirable objects.
- Do not hit or violently push the INTELLIGENT EYE sensor. This can lead to damage and malfunction.



**To start operation**

Press  and select the desired mode.

- Each time  is pressed, a different setting option is displayed on the LCD.
- When INTELLIGENT EYE is selected, the INTELLIGENT EYE lamp lights green.



Display

- By selecting “ ” from the following icons, the air conditioner will switch to COMFORT AIRFLOW operation combined with INTELLIGENT EYE operation.



- When the flaps (horizontal blades) are swinging, selecting any of the modes above will cause the flaps (horizontal blades) to stop.

**To cancel operation**

Press  until no icon is displayed.

- If the INTELLIGENT EYE operation was being used, the INTELLIGENT EYE lamp goes off.

**Useful Functions**

**INTELLIGENT EYE operation is useful for energy saving**

■ People are detected in the sensing area.

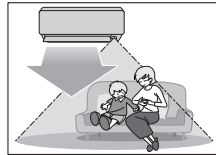

The air conditioner is in normal operation while the sensor is detecting human movement.

■ No people are detected in the sensing area.

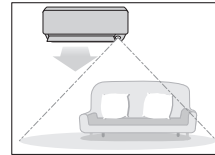

The air conditioner will switch to energy saving mode after 20 minutes.

**Energy saving operation**

- If no presence is detected in the room for 20 minutes, the energy saving operation will start, and the INTELLIGENT EYE lamp goes off. If human movement is detected again, the INTELLIGENT EYE lamp lights up and energy saving operation terminates.
- This operation changes the temperature by  $-3.6^{\circ}\text{F}$  ( $-2^{\circ}\text{C}$ ) in HEAT /  $+3.6^{\circ}\text{F}$  ( $+2^{\circ}\text{C}$ ) in COOL /  $+3.6^{\circ}\text{F}$  ( $+2^{\circ}\text{C}$ ) in DRY operation from the set temperature.
- When the room temperature exceeds  $86^{\circ}\text{F}$  ( $30^{\circ}\text{C}$ ), the operation changes the temperature by  $+1.8^{\circ}\text{F}$  ( $+1^{\circ}\text{C}$ ) in COOL /  $+1.8^{\circ}\text{F}$  ( $+1^{\circ}\text{C}$ ) in DRY operation from the set temperature.
- This operation decreases the airflow rate slightly in FAN operation only.

**NOTE**

**Note on COMFORT AIRFLOW operation**

- The airflow rate will be set to AUTO. If the up and down airflow direction is selected, COMFORT AIRFLOW operation will be canceled.

**Notes on INTELLIGENT EYE operation**

- Application range is as follows.

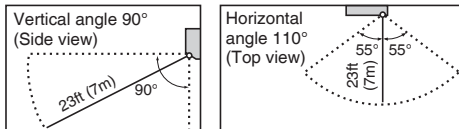

- The sensor may not detect moving objects further than 23ft (7m) away. (Please see the application range)
- Sensor detection sensitivity changes according to the indoor unit location, the speed of passers-by, temperature range, etc.
- The sensor could also mistakenly detect pets, sunlight, fluttering curtains and light reflected off of mirrors as passers-by.
- INTELLIGENT EYE operation will not switch on during POWERFUL operation.
- NIGHT SET mode (Page 20) will not switch on during use of INTELLIGENT EYE operation.

**Note on combination of COMFORT AIRFLOW operation and INTELLIGENT EYE operation**

- The airflow rate will be set to AUTO. If the up and down airflow direction is selected, COMFORT AIRFLOW operation will be canceled. Priority is given to the function of whichever button is pressed last.

**Useful Functions**



# POWERFUL Operation

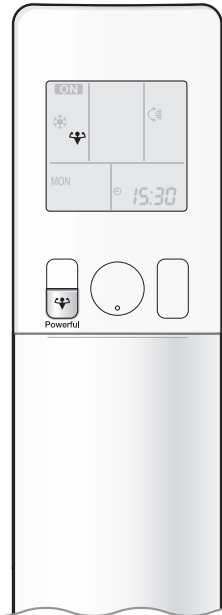

POWERFUL operation quickly maximizes the cooling (heating) effect in any operation mode. In this mode, the air conditioner operates at maximum capacity.

## To start POWERFUL operation

Press  during operation.

- “” is displayed on the LCD.
- POWERFUL operation ends in 20 minutes. Then the system automatically operates again with the previous settings which were used before POWERFUL operation.



## To cancel POWERFUL operation

Press  again.

- “” disappears from the LCD.

### NOTE

#### Notes on POWERFUL operation

- Pressing  causes the settings to be canceled, and “” disappears from the LCD.
- POWERFUL operation will not increase the capacity of the air conditioner if the air conditioner is already in operation with its maximum capacity demonstrated.

#### - In COOL, HEAT and AUTO operation

To maximize the cooling (heating) effect, the capacity of outdoor unit increases and the airflow rate becomes fixed at the maximum setting. The temperature and airflow settings cannot be changed.

#### - In DRY operation

The temperature setting is lowered by 4.5°F (2.5°C) and the airflow rate is slightly increased.

#### - In FAN operation

The airflow rate is fixed at the maximum setting.

#### Regarding the combination of POWERFUL and other operations

POWERFUL + COMFORT AIRFLOW	Not available*
POWERFUL + ECONO	
POWERFUL + QUIET OUTDOOR UNIT	

\*Priority is given to the function of whichever button is pressed last.

Useful Functions



# ECONO / QUIET OUTDOOR UNIT Operation

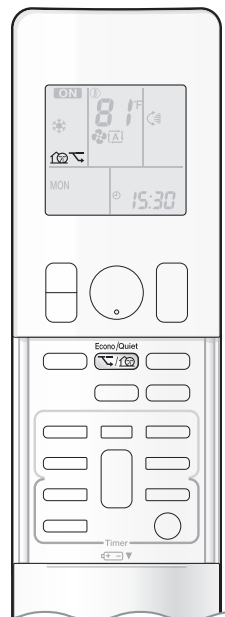

**ECONO operation** enables efficient operation by limiting the maximum power consumption.

This function is useful to prevent the circuit breaker from tripping when the unit operates alongside other appliances on the same circuit.

**QUIET OUTDOOR UNIT operation** lowers the noise level of the outdoor unit by changing the frequency and fan speed of the outdoor unit. This function is convenient during the night-time operation.

## To start operation

Press  and select the desired mode.

- Each time  is pressed, a different setting option is displayed on the LCD.





## To cancel operation

Press  until no icon is displayed.

### NOTE

#### Notes on ECONO operation

- Pressing  causes the settings to be canceled, and “” disappears from the LCD.
- If the power consumption level is already low, switching to ECONO operation will not reduce the power consumption.

#### Notes on QUIET OUTDOOR UNIT operation

- Even if the operation is stopped by using the remote controller or the indoor unit ON/OFF switch when using QUIET OUTDOOR UNIT operation, “” will remain displayed on the remote controller.
- QUIET OUTDOOR UNIT operation will not reduce the frequency nor fan speed if they already are operating at reduced levels.
- This operation is performed with lower power and therefore may not provide a sufficient cooling (heating) effect.

#### Possible combinations of ECONO / QUIET OUTDOOR UNIT operation and basic operations

	Operation mode				
	AUTO	DRY	COOL	HEAT	FAN
ECONO	✓	✓	✓	✓	—
QUIET OUTDOOR UNIT	✓	—	✓	✓	—

**TIMER Operation**



# ON/OFF TIMER Operation

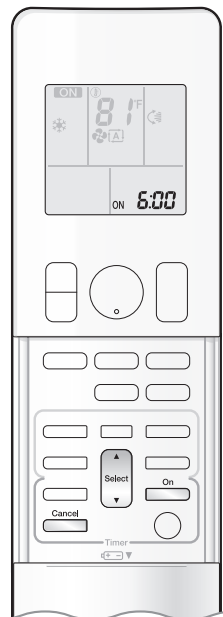

Timer functions are useful for automatically switching the air conditioner on or off in the morning or at night. You can also use the ON TIMER and OFF TIMER together.

**To use ON TIMER operation**

- Check that the clock is correct.  
If not, set the clock to the present time. ▶Page 10

**1. Press** .

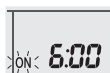

“6:00” is displayed on the LCD.  
“ON” blinks.

- “⌚” and day of the week disappear from the LCD.

**2. Press** **until the time setting reaches the point you like.**

- Each pressing of either button increases or decreases the time setting by 10 minutes.  
Holding down either button changes the setting rapidly.

**3. Press** **again.**

- “ON” and setting time are displayed on the LCD.
- The TIMER lamp lights orange. ▶Page 5



Display

**To cancel ON TIMER operation**

**Press** .

- “ON” and setting time disappear from the LCD.
- “⌚” and day of the week are displayed on the LCD.
- The TIMER lamp goes off.

**NOTE**

**Notes on TIMER operation**

- When TIMER is set, the present time is not displayed.
- When using the ON/OFF TIMER to start/stop operation, the actual operation start/stop time may differ from the time set. (Maximum of about 10 minutes)
- The ON/OFF TIMER remembers the time set previously.
- The ON TIMER will begin operation in the settings used previously for operation mode, temperature, airflow rate, and airflow direction.

**In the following cases, set the timer again.**

- After the circuit breaker has turned off.
- After a power failure.
- After replacing the batteries in the remote controller.

**TIMER Operation**

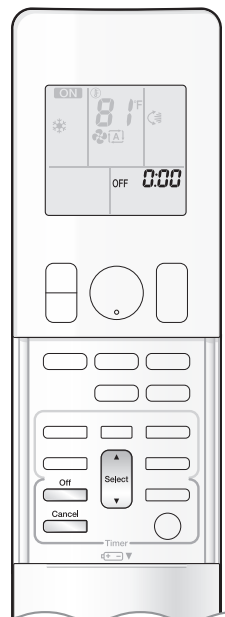

**To use OFF TIMER operation**

- Check that the clock is correct.  
If not, set the clock to the present time. ▶ Page 10

**1. Press**  .



“ 0:00 ” is displayed on the LCD.  
“ OFF ” blinks.

- “ ☉ ” and day of the week disappear from the LCD.

**2. Press**  **until the time setting reaches the point you like.**

- Each pressing of either button increases or decreases the time setting by 10 minutes.  
Holding down either button changes the time setting rapidly.

**3. Press**  **again.**

- “ OFF ” and setting time are displayed on the LCD.
- The TIMER lamp lights orange. ▶ Page 5



Display

**To cancel OFF TIMER operation**

**Press**  .

- “ OFF ” and setting time disappear from the LCD.
- “ ☉ ” and day of the week are displayed on the LCD.
- The TIMER lamp goes off.

**To combine ON TIMER and OFF TIMER operation**

- A sample setting for combining the 2 timers is shown below.

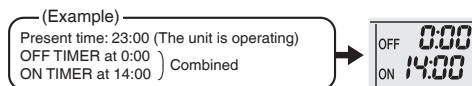

**NOTE**

**NIGHT SET mode**

- When the OFF TIMER is set, the air conditioner automatically adjusts the temperature setting (0.9°F (0.5°C) up in COOL, 3.6°F (2.0°C) down in HEAT) to prevent excessive cooling (heating) during sleeping hours.



**TIMER Operation**



# WEEKLY TIMER Operation

Up to 4 timer settings can be saved for each day of the week. This is convenient to adapt the WEEKLY TIMER to your family's lifestyle.

**Setting example of the WEEKLY TIMER**

The same timer settings are used from Monday through Friday, while different timer settings are used for the weekend.

<p><b>[Monday]</b></p>	<p>Make timer settings for programs 1-4. ▶ <b>Page 22</b></p>
<p><b>[Tuesday] to [Friday]</b></p>	<p>Use the copy mode to make settings for Tuesday to Friday, because these settings are the same as those for Monday. ▶ <b>Page 24</b></p>
<p><b>[Saturday]</b></p>	<p>No timer settings</p>
<p><b>[Sunday]</b></p>	<p>Make timer settings for programs 1-4. ▶ <b>Page 22</b></p>

- Up to 4 reservations per day and 28 reservations per week can be set using the WEEKLY TIMER. The effective use of the copy mode simplifies timer programming.
- The use of ON-ON-ON-ON settings, for example, makes it possible to schedule operating mode and set temperature changes. Furthermore, by using OFF-OFF-OFF-OFF settings, only the turn off time of each day can be set. This will turn off the air conditioner automatically if you forget to turn it off.

TIMER Operation

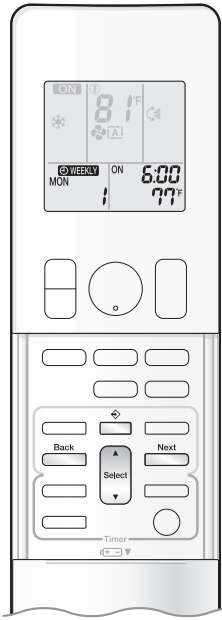

To use WEEKLY TIMER operation

Setting mode

- Make sure the day of the week and time are set.  
If not, set the day of the week and time. ▶ Page 10

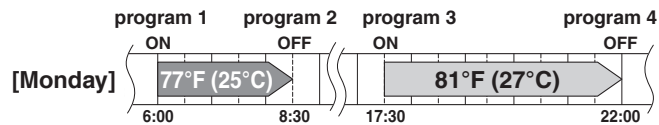

Setting Displays

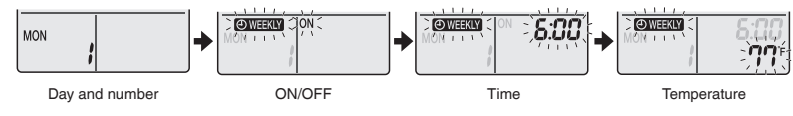

1. Press .

- The day of the week and the reservation number of the current day will be displayed.
- 1 to 4 settings can be made per day.

2. Press to select the desired day of the week and reservation number.

- Pressing changes the reservation number and the day of the week.

3. Press .

- The day of the week and reservation number will be set.
- “ WEEKLY” and “ON” blink.

4. Press to select the desired mode.

- Pressing changes the “ON” or “OFF” setting in sequence.



- In case the reservation has already been set, selecting “blank” deletes the reservation.
- Proceed to STEP 9 if “blank” is selected.
- To return to the day of the week and reservation number setting, press .

5. Press .

- The ON/OFF TIMER mode will be set.
- “ WEEKLY” and the time blink.

**TIMER Operation**



# WEEKLY TIMER Operation

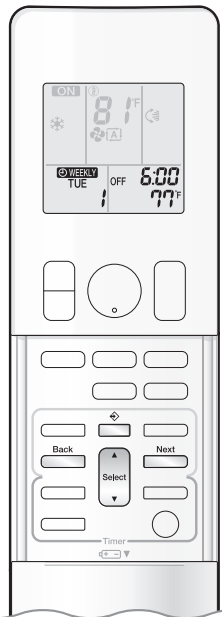

**6. Press to select the desired time.**

- The time can be set between 0:00 and 23:50 in 10-minute intervals.
- To return to the ON/OFF TIMER mode setting, press .
- Proceed to **STEP 9** when setting the OFF TIMER.

**7. Press .**

- The time will be set.
- “ WEEKLY” and the temperature blink.

**8. Press to select the desired temperature.**

- The temperature can be set between 50°F (10°C) and 90°F (32°C).  
 COOL or AUTO: The unit operates at 64°F (18°C) even if it is set at 50°F (10°C) to 63°F (17°C). [▶ Page 12](#)  
 HEAT or AUTO: The unit operates at 86°F (30°C) even if it is set at 87°F (31°C) to 90°F (32°C). [▶ Page 12](#)
- To return to the time setting, press .
- The set temperature is only displayed when the mode setting is on.

**9. Press .**

- Check for a receiving tone and that the OPERATION lamp blinks twice.
- The TIMER lamp lights orange.
- Temperature and time are set in the case of ON TIMER operation, and the time is set in the case of OFF TIMER operation.
- The next reservation screen will appear.
- To continue further settings, repeat the procedure from **STEP 4**.



Display

**10. Press to complete the setting.**

- “ WEEKLY” is displayed on the LCD and WEEKLY TIMER operation is activated.
- A reservation made once can be easily copied and the same settings used for another day of the week. Refer to [Copy mode](#). [▶ Page 24](#)

**NOTE**

**Notes on WEEKLY TIMER operation**

- Do not forget to set the clock on the remote controller first. [▶ Page 10](#)
- The day of the week, ON/OFF TIMER mode, time and set temperature (only for ON TIMER mode) can be set with the WEEKLY TIMER.  
 When set to ON TIMER mode, operation will begin in the settings used previously for operation mode, temperature, airflow rate, and airflow direction.
- WEEKLY TIMER and ON/OFF TIMER operation cannot be used at the same time. The ON/OFF TIMER operation has priority if it is set while WEEKLY TIMER is still active. The WEEKLY TIMER will enter the standby state, and “ WEEKLY” will disappear from the LCD. When the ON/OFF TIMER is up, the WEEKLY TIMER will automatically become active.
- Turning off the circuit breaker, power failure, and other similar events will render operation of the indoor unit’s internal clock inaccurate. Reset the clock. [▶ Page 10](#)
- can be used only for the time and temperature settings. It cannot be used to go back to the reservation number.

**TIMER Operation**

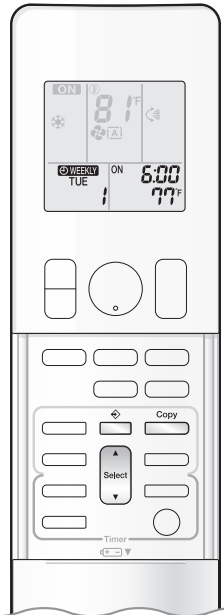

**Copy mode**

- A reservation made once can be copied to another day of the week. The whole reservation of the selected day of the week will be copied.

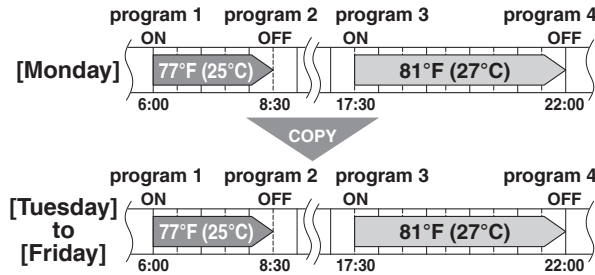

**Setting Displays**

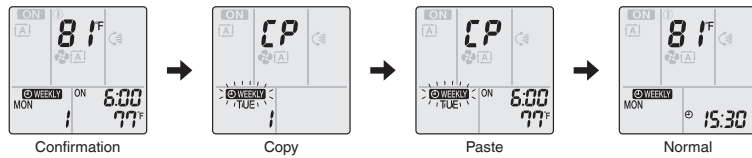

1. Press .
2. Press to confirm the day of the week to be copied.
3. Press .
  - The whole reservation of the selected day of the week will be copied.
4. Press to select the destination day of the week.
5. Press .
  - Check for a receiving tone and that the OPERATION lamp blinks twice.
  - The reservation will be copied to the selected day of the week. The whole reservation of the selected day of the week will be copied.
  - To continue copying the settings to other days of the week, repeat **STEP 4** and **STEP 5**.
6. Press to complete the setting.
  - “ WEEKLY” is displayed on the LCD and WEEKLY TIMER operation is activated.

**NOTE**

**Note on COPY MODE**

- The entire reservation of the source day of the week is copied in the copy mode.  
 In the case of making a reservation change for any day of the week individually after copying the content of weekly reservations, press and change the settings in the steps of **Setting mode** **Page 22**

**TIMER Operation**



# WEEKLY TIMER Operation

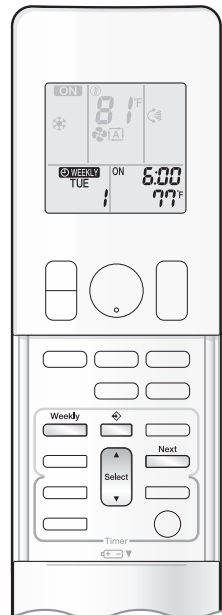

## Confirming a reservation

- The reservation can be confirmed.

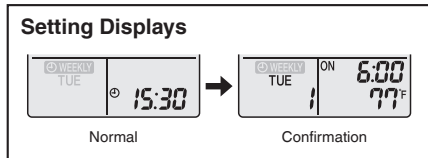

### 1. Press .

- The day of the week and the reservation number of the current day will be displayed.

### 2. Press to select the day of the week and the reservation number to be confirmed.

- Pressing displays the reservation details.
- To change the confirmed reserved settings, select the reservation number and press . The mode is switched to setting mode. Proceed to **Setting mode STEP 4.** [▶Page 22](#)

### 3. Press to exit the confirmation mode.

- “ ” is displayed on the LCD and WEEKLY TIMER operation is activated.

## To deactivate WEEKLY TIMER operation

### Press while “ ” is displayed on the LCD.

- “ ” disappears from the LCD.
- The TIMER lamp goes off.
- To reactivate the WEEKLY TIMER operation, press again.
- If a reservation deactivated with is activated once again, the last reservation mode will be used.

**NOTE**

- If not all the reservation settings are reflected, deactivate the WEEKLY TIMER operation once. Then press again to reactivate the WEEKLY TIMER operation.

**TIMER Operation**

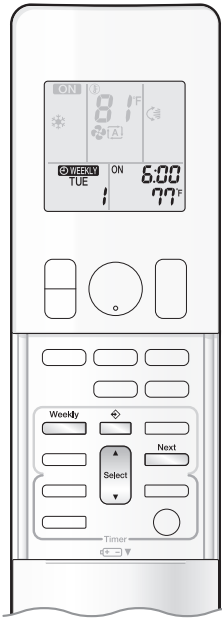

**To delete reservations**

**An individual reservation**

- 1. Press** .  
 • The day of the week and the reservation number will be displayed.
  - 2. Press** **to select the day of the week and the reservation number to be deleted.**
  - 3. Press** .  
 • “ WEEKLY” and “ON” or “OFF” blink.
  - 4. Press** **until no icon is displayed.**  
 • Pressing changes the ON/OFF TIMER mode in sequence.  
 • Selecting “blank” will cancel any reservation you may have.
- 
- 5. Press** .  
 • Check for a receiving tone and that the OPERATION lamp blinks twice.  
 • The selected reservation will be deleted.
  - 6. Press** .  
 • If there are still other reservations, WEEKLY TIMER operation will be activated.

**Reservations for each day of the week**

- This function can be used for deleting reservations for each day of the week.
  - It can be used while confirming or setting reservations.
- 1. Press** .  
 • The day of the week and the reservation number will be displayed.
  - 2. Press** **to select the day of the week to be deleted.**
  - 3. Hold** **for about 5 seconds.**  
 • Check for a receiving tone and that the OPERATION lamp blinks twice.  
 • The reservation of the selected day of the week will be deleted.
  - 4. Press** .  
 • If there are still other reservations, WEEKLY TIMER operation will be activated.

**All reservations**

- **Hold** **for about 5 seconds with the normal display.**  
 • Check for a receiving tone and that the OPERATION lamp blinks twice.  
 • “ WEEKLY” disappears from the LCD.  
 • The TIMER lamp goes off.  
 • All reservations will be deleted.  
 • This operation is not functional while the WEEKLY TIMER setting screen is displayed.

Care

# Care and Cleaning

## ⚠ CAUTION

- Before cleaning, be sure to stop the operation and turn off the circuit breaker.
- Do not touch the aluminum fins of the indoor unit. If you touch those parts, this may cause an injury.

### ■ Quick reference

#### Cleaning parts

**Front panel**

- Wipe with a soft cloth which has been moistened with water or neutral detergent.
- Wipe with a soft dry cloth.

**If dirty**



**Air filter**

- Vacuum dust or wash the filter.

**Once every 2 weeks**

▶ Page 29

**Titanium apatite deodorizing filter**

- Vacuum dust or replace the filter.

**[Cleaning]** **Once every 6 months** ▶ Page 30

**[Replacement]** **Once every 3 years** ▶ Page 30

**Indoor unit and remote controller**

- Wipe them with a soft cloth.

**If dirty**

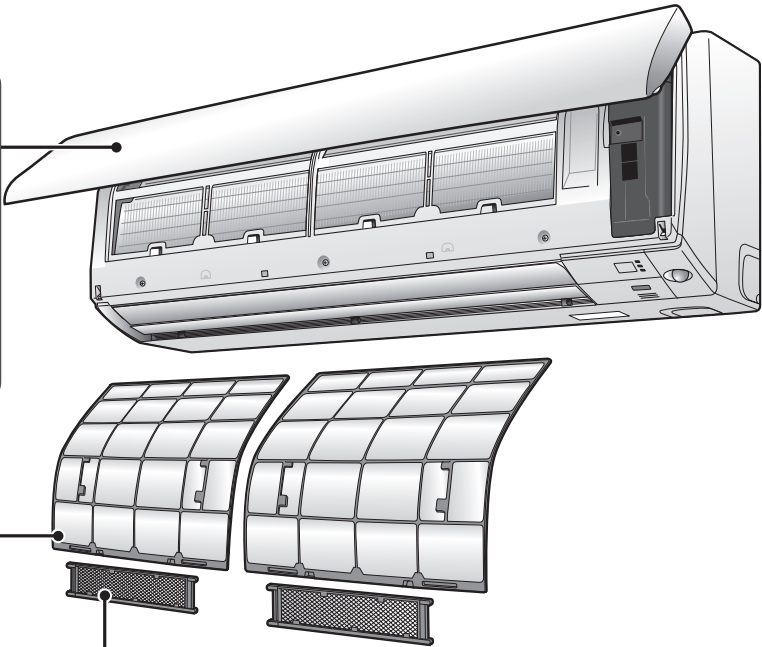

## NOTE

For cleaning, do not use any of the following:

- Water hotter than 104°F (40°C)
- Volatile liquid such as benzene, gasoline and thinner
- Polishing compounds
- Rough materials such as a scrubbing brush
- Sprays such as deodorizers



**⚠ CAUTION**

- When removing or attaching the front panel, stand on a solid, stable base and take care not to fall.
- When removing or attaching the front panel, support the panel securely with your hand to prevent it from falling.

**■ Front panel**

**1. Open the front panel.**

- Hold the front panel by the panel tabs on the 2 sides and open it.

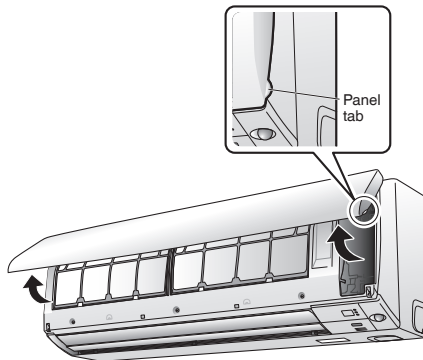

**2. Remove the front panel.**

- 1) Slide the front panel to either the left or right and pull it toward you to disengage one of the front panel shafts.

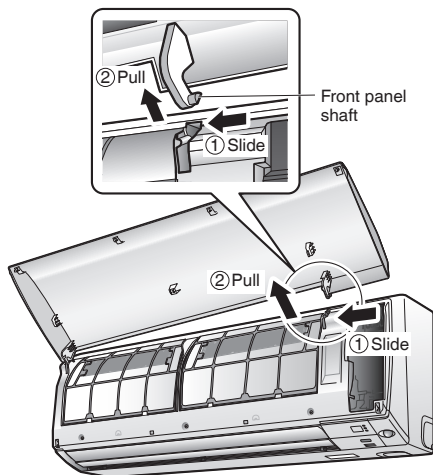

- 2) Disengage the front panel shaft on the other side in the same manner.
- 3) After disengaging both front panel shafts, pull the front panel toward yourself and remove it.

**3. Clean the front panel.**

- Wipe it with a soft damp cloth.
- Only neutral detergent may be used.
- In case of washing the panel with water, wipe it with a dry soft cloth, and let it dry in the shade after washing.

**4. Attach the front panel.**

- Align the front panel shaft on the left and right of the front panel with the grooves, then push them all the way in.

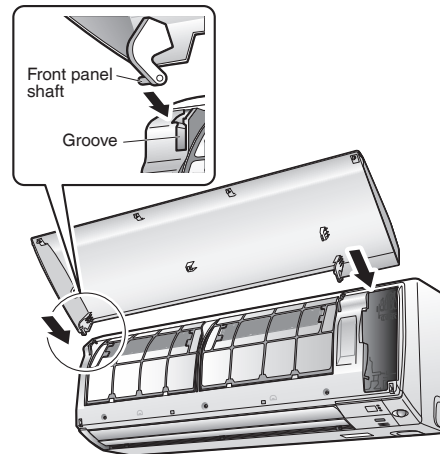

**5. Close the front panel slowly.**

- Press the front panel at both sides and in the central area.

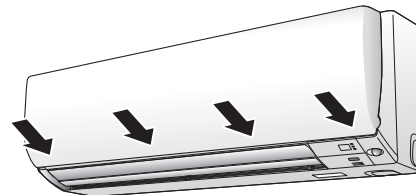

- Make sure that the front panel is securely fixed.



Care

# Care and Cleaning

## ■ Air filter

**1. Open the front panel.** ▶Page 28

**2. Pull out the air filters.**

- Push the filter tab at the center of each air filter a little upwards, then pull it down.

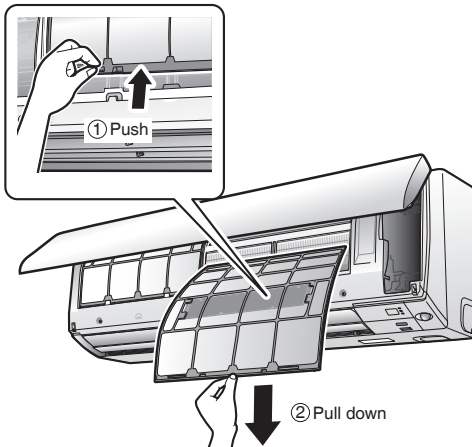

**3. Wash the air filters with water or clean them with a vacuum cleaner.**

- It is recommended to clean the air filters every 2 weeks.

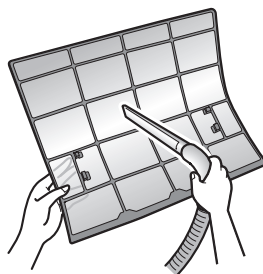

**If the dust does not come off easily**

- Wash the air filters with neutral detergent thinned with lukewarm water, then let them dry in the shade.
- Be sure to remove the titanium apatite deodorizing filter. Refer to "Titanium apatite deodorizing filter" on the next page.



**4. Reattach the filters.**

**5. Close the front panel slowly.**

▶Page 28

■ Titanium apatite deodorizing filter

**1. Open the front panel and pull out the air filters.** ▶ Page 28, 29

**2. Take off the titanium apatite deodorizing filters.**

- Hold the recessed parts of the frame and unhook the 4 claws.

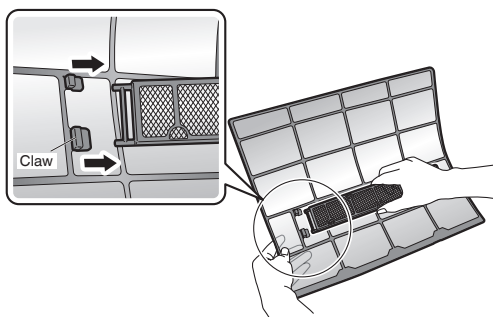

**3. Clean or replace the titanium apatite deodorizing filters.**

[Cleaning]

**3-1 Vacuum dust, and soak in lukewarm water or water for about 10 to 15 minutes if very dirty.**

- Do not remove the filter from the frame when washing with water.



**3-2 After washing, shake off remaining water and let them dry in the shade.**

- Do not wring out the filter to remove water from it.

[Replacement]

**Remove the filter from the filter frame and attach a new one.**

- Do not throw away the filter frame. Reuse the filter frame when replacing the titanium apatite deodorizing filter.
- When attaching the filter, check that the filter is properly set in the tabs.

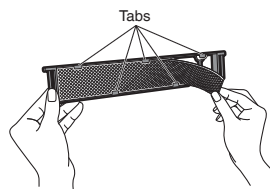

- Dispose of the old filter as non-flammable waste.

**4. Set the titanium apatite deodorizing filters as they were.**

**5. Reattach the filters.** ▶ Page 29

**6. Close the front panel slowly.** ▶ Page 28

NOTE

- Operation with dirty filters:
  - cannot deodorize the air,
  - cannot clean the air,
  - results in poor heating or cooling,
  - may cause odor.
- Dispose of old filters as non-flammable waste.
- To order a titanium apatite deodorizing filter, contact the dealer where you bought the air conditioner.

Item	Titanium apatite deodorizing filter (without frame) 1 set
Part No.	KAF970A46



## Care

## Care and Cleaning

---

### ■ Prior to a long period of non-use

#### **1. Operate the FAN mode for several hours on a fine day to dry out the inside.**

- 1) Press  and select “ and start the operation.

#### **2. After operation stops, turn off the circuit breaker for the room air conditioner.**

#### **3. Clean the air filters and reattach them.**

#### **4. To prevent battery leakage, take out the batteries from the remote controller.**

- When starting to use the air conditioner again, make sure that the drain hose outlet is not blocked, then turn on the circuit breaker.  
An operational check of each component will be carried out automatically. (Also, put the batteries into the remote controller.)

### ■ We recommend periodical maintenance

- In certain operating conditions, the inside of the air conditioner may get foul after several seasons of use, resulting in poor performance. It is recommended to have periodical maintenance by a qualified contractor in addition to regular cleaning by the user.
- For qualified contractor maintenance, please contact the dealer where you bought the air conditioner.

When the Need Arises

# FAQ

## Indoor unit

### The flaps do not start swinging immediately.

- The air conditioner is adjusting the position of the flaps. The flaps will start moving soon.

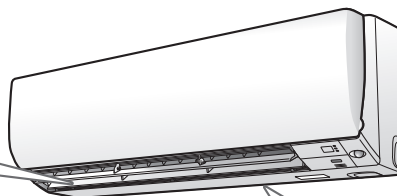

### The air conditioner stops generating airflow during HEAT operation.

- Once the set temperature is reached, the airflow rate is reduced and operation stopped in order to avoid generating a cool airflow. Operation will resume automatically when the indoor temperature falls.

### HEAT operation stops suddenly and a flowing sound is heard.

- The outdoor unit is defrosting. HEAT operation starts after the frost on the outdoor unit has been removed. This can take about 4 to 12 minutes.

### Operation does not start soon.

- **When the unit is turned on again soon after being turned off.**
- **When the mode was reselected.**
  - This is to protect the air conditioner. You should wait for about 3 minutes.

### Different sounds are heard.

- **A sound like flowing water**
  - This sound is generated because the refrigerant in the air conditioner is flowing.
  - This is a pumping sound of the water in the air conditioner and can be heard when the water is pumped out from the air conditioner during COOL or DRY operation.
- **Blowing sound**
  - This sound is generated when the flow of the refrigerant in the air conditioner is switched over.
  - If the outdoor temperature is low, this sound is generated when the direction of the flow of the refrigerant in the piping changes at the start of defrost operation, after HEAT operation is stopped and the room temperature is stabilized.
- **Ticking sound**
  - This sound is generated when the cabinet and frame of the air conditioner slightly expand or shrink as a result of temperature changes.
- **Whistling sound**
  - This sound is generated when refrigerant flows during defrosting operation.
- **Clicking sound during operation or idle time**
  - This sound is generated when the refrigerant control valves or the electrical parts operate.
- **Clipping sound**
  - This sound is heard from the inside of the air conditioner when the exhaust fan is activated while the room doors are closed. Open the window or turn off the exhaust fan.

## Outdoor unit

### Operating sound is loud.

- When frost forms on the heat exchanger of the outdoor unit, the operating sound level increases slightly.

### The outdoor unit emits water or steam.

- **In HEAT operation**
  - The frost on the outdoor unit melts into water or steam when the air conditioner is in defrosting operation.
- **In COOL or DRY operation**
  - Moisture in the air condenses into water on the cool surface of the outdoor unit piping and drips.

### Blowing sound

- If the outdoor temperature is low, this sound is generated when the direction of the flow of the refrigerant in the piping changes at the start of defrost operation, after HEAT operation is stopped and the room temperature is stabilized.

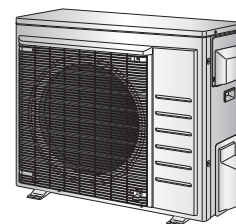



**When the Need Arises**

# Troubleshooting

Before making an inquiry or a request for repair, please check the following.  
If the problem persists, consult your dealer.



	<b>Not a problem</b> This case is not a problem.		<b>Check</b> Please check again before requesting repairs.
---	---	---	---

## The air conditioner does not operate

Case	Description / what to check
OPERATION lamp is off.	 <ul style="list-style-type: none"> <li>Has the circuit breaker been tripped or the fuse blown?</li> <li>Is there a power failure?</li> <li>Are batteries set in the remote controller?</li> </ul>
OPERATION lamp is blinking.	 <ul style="list-style-type: none"> <li>Turn off the power with the circuit breaker and restart operation with the remote controller. If the OPERATION lamp is still blinking, check the error code and consult your dealer.</li> </ul>

▶ Page 37, 38

## The air conditioner suddenly stops operating



Case	Description / what to check
OPERATION lamp is on.	 <ul style="list-style-type: none"> <li>To protect the system, the air conditioner may stop operating after sudden large voltage fluctuations. It automatically resumes operation in about 3 minutes.</li> </ul>
OPERATION lamp is blinking.	 <ul style="list-style-type: none"> <li>Are the air filters dirty? Clean the air filters.</li> <li>Is there anything blocking the air inlet or air outlet of the indoor unit or outdoor unit? Stop operation and after turning off the circuit breaker, remove the obstruction. Then restart operation with the remote controller. If the OPERATION lamp is still blinking, check the error code and consult your dealer.</li> </ul>

▶ Page 37, 38

## The air conditioner does not stop operating

Case	Description / what to check
The air conditioner continues operating even after operation is stopped.	 <ul style="list-style-type: none"> <li><b>Immediately after the air conditioner is stopped</b> <ul style="list-style-type: none"> <li>The outdoor unit fan continues rotating for about another 1 minute to protect the system.</li> </ul> </li> <li><b>While the air conditioner is not in operation</b> <ul style="list-style-type: none"> <li>When the outdoor temperature is high, the outdoor unit fan may start rotating to protect the system.</li> </ul> </li> </ul>

## The room does not cool down / warm up

Case	Description / what to check
Air does not come out.	 <ul style="list-style-type: none"> <li><b>In HEAT operation</b> <ul style="list-style-type: none"> <li>To prevent the release of cold air, air does not come out directly after operation is started. Please wait 1 to 4 minutes.</li> <li>During defrosting operation, hot air does not flow out of the indoor unit.</li> </ul> </li> <li><b>When the air conditioner operates immediately after the circuit breaker is turned on</b> <ul style="list-style-type: none"> <li>The air conditioner is preparing to operate. Wait for about 3 to 10 minutes.</li> </ul> </li> </ul>
Air does not come out / Air comes out.	 <ul style="list-style-type: none"> <li><b>Is the airflow rate setting appropriate?</b> <ul style="list-style-type: none"> <li>Is the airflow rate setting low, such as "Indoor unit quiet" or "Airflow rate 1"? Increase the airflow rate setting.</li> </ul> </li> <li><b>Is the set temperature appropriate?</b></li> <li><b>Is the adjustment of the airflow direction appropriate?</b></li> </ul>
Air comes out.	 <ul style="list-style-type: none"> <li>Is there any furniture directly under or beside the indoor unit?</li> <li>Is the air conditioner in ECONO operation or QUIET OUTDOOR UNIT operation? ▶ Page 18</li> <li>Are the air filters dirty?</li> <li>Is there anything blocking the air inlet or air outlet of the indoor unit or outdoor unit?</li> <li>Is a window or door open?</li> <li>Is an exhaust fan turning?</li> <li>Depending on the room conditions, number of occupants, or outdoor temperature and humidity, the set temperature may not be reached.</li> </ul>

**When the Need Arises**

**Water or mist comes out**

Case	Description / what to check
Mist comes out of the indoor unit.	<input checked="" type="checkbox"/> • This happens when the air in the room is cooled into mist by the cold airflow during COOL or other operation.
Water is leaking from the indoor unit	<input type="checkbox"/> • If the drain hose is crushed or clogged, water from the indoor unit may be unable to drain and start leaking. Stop operation of the unit immediately and contact your dealer.

**Remote controller**

Case	Description / what to check
The unit does not receive signals from the remote controller or has a limited operating range.	<input checked="" type="checkbox"/> • The batteries may be exhausted. Replace both batteries with new dry batteries AAA.LR03 (alkaline). For details, refer to “ <b>Preparation Before Operation</b> ”. ▶ <b>Page 9</b> <input type="checkbox"/> • Signal communication may be disabled if an electronic-starter-type fluorescent lamp (such as inverter-type lamps) is in the room. Consult your dealer if that is the case. <input type="checkbox"/> • The remote controller may not function correctly if the transmitter is exposed to direct sunlight. <input type="checkbox"/> • Is there a device in the room that redirects remote controller signals? Some appliances such as TV speakers are equipped with these devices. If there is such a device in the room, the signals it emits may interfere with signals from the remote controller, preventing reception. <input type="checkbox"/> • Infrared rays from smartphones and game consoles may interfere with signals from the remote controller, preventing reception.
LCD is faint, is not working, or the display is erratic.	<input checked="" type="checkbox"/> • The batteries may be exhausted. Replace both batteries with new dry batteries AAA.LR03 (alkaline). For details, refer to “ <b>Preparation Before Operation</b> ”. ▶ <b>Page 9</b>
Other electric devices start operating.	<input checked="" type="checkbox"/> • If the remote controller activates other electric devices, move them away or consult your dealer.







**Air has an odor**

Case	Description / what to check
The air conditioner gives off an odor.	<input checked="" type="checkbox"/> • The room odor absorbed in the unit is discharged with the airflow. We recommend you to have the indoor unit cleaned. Please consult your dealer.
	<input checked="" type="checkbox"/> • The indoor unit is blowing out room odor it has absorbed (the smell of walls or carpeting, furniture, clothes, and so on). If the air conditioner has been used for a long time, there is a chance that a dirty heat exchanger or fan are emitting an odor. We recommend you to have the indoor unit cleaned. Please consult your dealer. Do not spray the air conditioner unit with any deodorizers.

**When the Need Arises**

# Troubleshooting

## Others

Case	Description / what to check
The air conditioner suddenly starts behaving strangely during operation.	<p> • The air conditioner may malfunction due to lightning or radio. If the air conditioner malfunctions, turn off the power with the circuit breaker and restart the operation with the remote controller.</p>
HEAT operation cannot be selected, even though the unit is heat pump model.	<p> • Check that the jumper (J8) has not been cut. If it has been cut, contact your dealer.</p> 
The WEEKLY TIMER does not operate according to the settings.	<p> • Check if the ON/OFF TIMER and the WEEKLY TIMER are set to the same time. Change or deactivate the settings in the ON/OFF TIMER. <b>▶ Page 19, 20</b></p>
The ON/OFF TIMER does not operate according to the settings.	<p> • Check if the ON/OFF TIMER and the WEEKLY TIMER are set to the same time. Change or deactivate the settings in the WEEKLY TIMER. <b>▶ Page 21</b></p>
The ceiling and walls around the indoor unit are black and dirty.	<p> • Due to the circulation pattern of the air and static electricity, the air conditioner is causing airborne dirt and dust to stick to walls and other surfaces. Depending on the wallpaper type, dirt may adhere more easily. A thorough cleaning of the area around the air conditioner is recommended.</p>

### Notes on the operating conditions

- If operation continues under any conditions other than those listed in the table,
  - A safety device may activate to stop the operation.
  - Dew may form on the indoor unit and drip from it when COOL or DRY operation is selected.
- \*1 Turning on switch on the outdoor unit PCB will extend the cooling operation range to 14°F (–10°C).  
Installing an air direction adjustment grille (sold separately) will further extend the operation range to –4°F (–20°C).  
Please consult your dealer.
- \*2 Installing a drain pan heater (sold separately) will further extend the heating operation range to –13°F (–25°C).  
Please consult your dealer.

Mode	Operating conditions
COOL / DRY	Outdoor temperature: 50*1 - 115°F (10*1 - 46°C) *1 –4°F (–20°C) if an air direction adjustment grille (sold separately) is installed. Indoor temperature : 64 - 90°F (18 - 32°C) Indoor humidity : 80% max.
HEAT	Outdoor temperature: 5*2 - 75°F (–15*2- 24°C) *2 –13°F (–25°C) if a drain pan heater (sold separately) is installed. Indoor temperature : 50 - 86°F (10 - 30°C)

**When the Need Arises**

**■ Call your dealer immediately**

** WARNING**

**When an abnormality (such as a burning smell) occurs, stop operation and turn off the circuit breaker.**

- Continued operation in an abnormal condition may result in problems, electric shock or fire.
- Consult the dealer where you bought the air conditioner.

**Do not attempt to repair or modify the air conditioner by yourself.**

- Incorrect work may result in electric shock or fire.
- Consult the dealer where you bought the air conditioner.

**If one of the following symptoms takes place, call your dealer immediately.**

- The power cord is abnormally hot or damaged.
- An abnormal sound is heard during operation.
- The circuit breaker cuts off the operation frequently.
- A switch or a button often fails to work properly.
- There is a burning smell.
- Water leaks from the indoor unit.

Turn off the circuit breaker and call your dealer. 

- After a power failure**
  - The air conditioner automatically resumes operation in about 3 minutes. Please wait for a while.
- Lightning**
  - If there is a risk lightning could strike in the neighborhood, stop operation and turn off the circuit breaker to protect the system.

**■ Disposal requirements**

- Dismantling of the unit, handling of the refrigerant, oil and other parts, should be done in accordance with the relevant local and national regulations.



**When the Need Arises**

# Troubleshooting

## The OPERATION lamp blinks

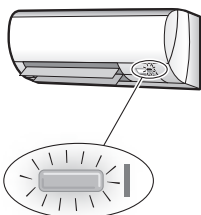

■ Check the interval time between blinks of the OPERATION lamp.

**[Blink interval of about 0.5 seconds]**  
 This is a notification of an abnormality.  
 Check the error code following the procedure below, and respond according to the instructions in the table.

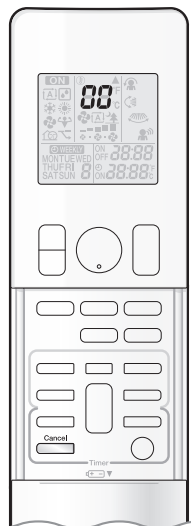

■ Fault diagnosis by remote controller

1. When is held down for about 5 seconds, "00" blinks in the temperature display section.
2. While pointing the remote controller at the indoor unit, press repeatedly.  
 A beep indicates a non-corresponding error code.  
 A long beep indicates a corresponding error code.
3. When a long beep is produced, check the error code and respond according to the instructions in the table.
  - To cancel the code display, hold down for about 5 seconds (the code display also clears if no button is pressed for a while).

CODE	Cause	Description / what to check
E7	The fan of the outdoor unit is stopped. • Is there any foreign matter inside the outdoor unit?	After turning off the circuit breaker, remove the foreign matter, then turn the power on again and operate.
L3, L4, L5	The temperature inside the outdoor unit has become too high, so operation has stopped. • Is there anything blocking the air outlet of the outdoor unit?	After turning off the circuit breaker, remove the obstruction, then turn the power on again and operate.
Other error codes, or if the error code cannot be checked		An abnormality has occurred.

In the case of error code U0 or F3

When the Need Arises

	CODE	MEANING
SYSTEM	00	NORMAL
	UA	INDOOR-OUTDOOR UNIT COMBINATION FAULT
	U0	REFRIGERANT SHORTAGE
	U2	DROP VOLTAGE OR MAIN CIRCUIT OVERVOLTAGE
	U4	FAILURE OF TRANSMISSION (BETWEEN INDOOR UNIT AND OUTDOOR UNIT)
INDOOR UNIT	A1	INDOOR PCB DEFECTIVENESS
	A6	FAN MOTOR FAULT
	C4	FAULTY HEAT EXCHANGER TEMPERATURE SENSOR
	C9	FAULTY SUCTION AIR TEMPERATURE SENSOR
OUTDOOR UNIT	EA	COOLING-HEATING SWITCHING ERROR
	E1	CIRCUIT BOARD FAULT
	E3	HIGH PRESSURE SWITCH (HPS) ACTIVATED
	E5	OL STARTED
	E6	FAULTY COMPRESSOR START UP
	E7	DC FAN MOTOR FAULT
	F3	HIGH TEMPERATURE DISCHARGE PIPE CONTROL
	H0	SENSOR FAULT
	H6	OPERATION HALT DUE TO FAULTY POSITION DETECTION SENSOR
	H8	DC CURRENT SENSOR FAULT
	H9	FAULTY SUCTION AIR TEMPERATURE SENSOR
	J3	FAULTY DISCHARGE PIPE TEMPERATURE SENSOR
	J6	FAULTY HEAT EXCHANGER TEMPERATURE SENSOR
	L3	ELECTRICAL PARTS HEAT FAULT
	L4	HIGH TEMPERATURE AT INVERTER CIRCUIT HEATSINK
	L5	OUTPUT OVERCURRENT
P4	FAULTY INVERTER CIRCUIT HEATSINK TEMPERATURE SENSOR	

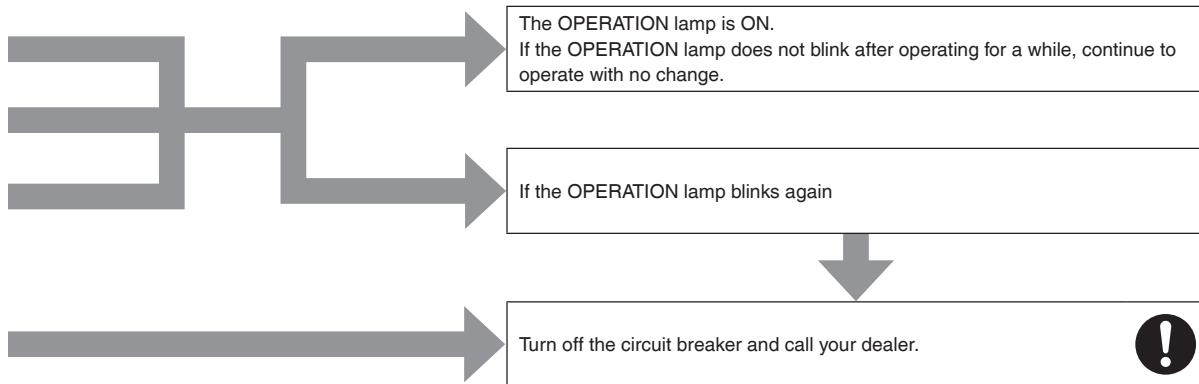

# Quick Reference

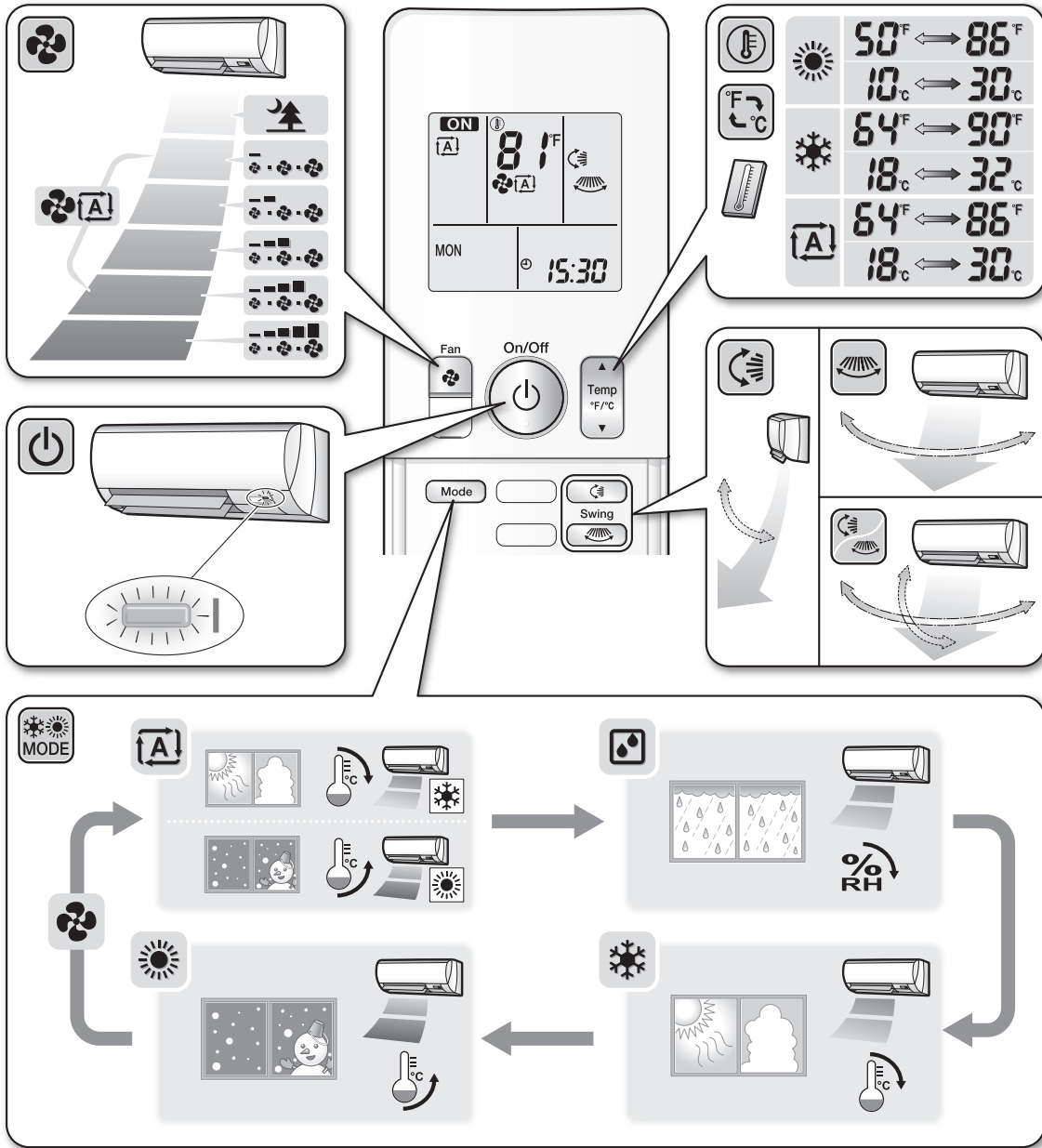

### 13.3 FVXS





# Safety Considerations

Refer also to the General Safety Considerations in the separate booklet.

	<b>Read the precautions in this manual carefully before operating the unit.</b>
---	---

Read these **Safety Considerations for Operations** carefully before operating an air conditioner or heat pump. Make sure that the unit operates properly during the startup operation. Instruct the user on how to operate and maintain the unit. Inform users that they should store this operation manual with the installation manual for future reference.

Meanings of **DANGER**, **WARNING**, **CAUTION**, and **NOTE** Symbols:

-  **DANGER** ..... Indicates an imminently hazardous situation which, if not avoided, will result in death or serious injury.
-  **WARNING** ..... Indicates a potentially hazardous situation which, if not avoided, could result in death or serious injury.
-  **CAUTION** ..... Indicates a potentially hazardous situation which, if not avoided, may result in minor or moderate injury. It may also be used to alert against unsafe practices.
-  **NOTE** ..... Indicates situations that may result in equipment or property damage accidents only.

—  **DANGER** —

- Do not install the unit in an area where flammable materials are present due to risk of explosion resulting in serious injury or death.
- Any abnormalities in the operation of the air conditioner or heat pump, such as smoke or fire, could result in severe injury or death. Turn off the power and contact your dealer immediately.
- Refrigerant gas may produce toxic gas if it comes into contact with fire, such as from a fan heater, stove, or cooking device. Exposure to this gas could cause severe injury or death.
- For refrigerant leakage, consult your dealer. Refrigerant gas is heavier than air and replaces oxygen. A massive leak could lead to oxygen depletion, especially in basements, and an asphyxiation hazard could occur leading to serious injury or death.
- If equipment utilizing a burner is used in the same room as the air conditioner or heat pump, there is the danger of oxygen deficiency which could lead to an asphyxiation hazard resulting in serious injury or death. Be sure to ventilate the room sufficiently to avoid this hazard.
- Safely dispose of the packing materials. Packing materials, such as nails and other metal or wooden parts, may cause stabs or other injuries.
- Tear apart and throw away plastic packaging bags so that children will not play with them. Children playing with plastic bags face the danger of death by suffocation.

—  **WARNING** —

- Contact your dealer for repair and maintenance. Improper repair and maintenance may result in water leakage, electric shock, and fire. Only use accessories made by Daikin that are specifically designed for use with the equipment and have them installed by a professional.
- Contact your dealer to move and reinstall the air conditioner or heat pump. Incomplete installation may result in water leakage, electric shock, and fire.
- Never let the indoor unit or the remote controller get wet. Water can cause an electric shock or a fire.
- Never use flammable spray such as hair spray, lacquer, or paint near the unit. Flammable spray may cause a fire.
- When a fuse blows out, never replace it with one of incorrect ampere ratings or different wires. Always replace any blown fuse with a fuse of the same specification.
- Never remove the fan guard of the unit. A fan rotating at high speed without the fan guard is very dangerous.
- Never inspect or service the unit by yourself. Contact a qualified service person to perform this work.
- Turn off all electrical power before doing any maintenance to avoid the risk of serious electric shock; never sprinkle or spill water or liquids on the unit.
- Do not touch the switch with wet fingers. Touching a switch with wet fingers can cause electric shock.
- Do not allow children to play on or around the unit to prevent injury.
- The heat exchanger fins are sharp enough to cut. To avoid injury wear gloves or cover the fins while working around them.
- Do not put a finger or other objects into the air inlet or air outlet. The fan is rotating at high speed and will cause injury.
- Check the unit foundation for damage on a continuous basis, especially if it has been in use for a long time. If left in a damaged condition the unit may fall and cause injury.
- Placing a flower vase or other containers with water or other liquids on the unit could cause a shock or fire if a spill occurs.
- Do not touch the air outlet or horizontal blades while the swing flap is in operation because fingers could get caught and injured.
- Never touch the internal parts of the controller. Do not remove the front panel because some parts inside are dangerous to touch. To check and adjust internal parts, contact your dealer.
- Do not use means to accelerate the defrosting process or to clean, other than those recommended by the manufacturer.
- The appliance must be stored in a room without continuously operating ignition sources (for example: open flames, an operating gas appliance or an operating electric heater).
- Do not pierce or burn.
- Be aware that refrigerants may not contain an odor.

— **⚠ CAUTION** —

- Do not use the air conditioner or heat pump for any other purposes other than comfort cooling or heating. Do not use the unit for cooling precision instruments, food, plants, animals or works of art.
- Do not place items under the indoor unit as they may be damaged by condensates that may form if the humidity is above 80% or if the drain outlet gets blocked.
- Before cleaning, stop the operation of the unit by turning the power off or by pulling the supply cord out from its receptacle. Otherwise, an electric shock and injury may result.
- Do not wash the air conditioner or heat pump with excessive water. An electric shock or fire may result.
- Avoid placing the controller in a spot which may be splashed with water. Water entering the controller may cause an electric shock or damage the internal electronic parts.
- Do not operate the air conditioner or heat pump when using a room-fumigation type of insecticide. Failure to observe this could cause the chemicals to be deposited in the unit and can endanger the health of those who are hypersensitive to chemicals.
- Do not turn off the power immediately after stopping operation. Always wait for at least 5 minutes before turning off the power. Otherwise, water leakage may occur.
- The appliance is not intended for use by young children or infirm persons without supervision.
- The remote controller should be kept away from children so they cannot play with it.
- Consult with the installation contractor for cleaning.
- Incorrect cleaning of the inside of the air conditioner or heat pump could make the plastics parts break and cause water leakage or electric shock.
- Do not touch the air inlet or aluminum fin of the air conditioner or heat pump as they can cut and cause injury.
- Do not place objects in direct proximity of the outdoor unit. Do not let leaves and other debris accumulate around the unit. Leaves are a hotbed for small animals which can enter the unit. Once inside the unit, animals can cause the unit to malfunction, and cause smoke or fire when they make contact with electrical parts.

— **⚠ NOTE** —

- Never press the button of the remote controller with a hard, pointed object. The remote controller may be damaged.
- Never pull or twist the electric wire of the remote controller. It may cause the unit to malfunction.
- Do not place appliances that produce open flames in places that are exposed to the airflow of the unit or under the indoor unit. It may cause incomplete combustion or deformation of the unit due to the heat.
- Do not expose the controller to direct sunlight. The LCD display can become discolored and may fail to display the data.

- Do not wipe the controller operation panel with benzine, thinner, chemical dust cloth, etc. The panel may get discolored or the coating can peel off. If it is heavily dirty, soak a cloth in water-diluted neutral detergent, squeeze it well and wipe the panel clean. Then wipe it with another dry cloth.
- Dismantling of the unit, disposal of the refrigerant, oil, and additional parts, should be done in accordance with the relevant local, state, and national regulations.
- Operate the air conditioner or heat pump in a sufficiently ventilated area and not surrounded by obstacles. Do not use the air conditioner or heat pump in the following places.
  - a. Places with a mist of mineral oil, such as cutting oil.
  - b. Locations such as coastal areas where there is a lot of salt in the air.
  - c. Locations such as hot springs where there is a lot of sulfur in the air.
  - d. Locations such as factories where the power voltage varies a lot.
  - e. In cars, boats, and other vehicles.
  - f. Locations such as kitchens where oil may splatter or where there is steam in the air.
  - g. Locations where equipment produces electromagnetic waves.
  - h. Places with an acid or alkaline mist.
  - i. Places where fallen leaves can accumulate or where weeds can grow.
- Take snow protection measures. Contact your dealer for the details of snow protection measures, such as the use of a snow protection hood.
- Do not attempt to do electrical work or grounding work unless you are licensed to do so. Consult with your dealer for electrical work and grounding work.
- Pay attention to operating sound. Be sure to use the following places:
  - a. Places that can sufficiently withstand the weight of the air conditioner or heat pump yet can suppress the operating sound and vibration.
  - b. Places where warm air from the air outlet of the outdoor unit or the operating sound of the outdoor unit does not annoy neighbors.
- Make sure that there are no obstacles close to the outdoor unit. Obstacles close to the outdoor unit may drop the performance of the outdoor unit or increase the operating sound of the outdoor unit.
- Consult your dealer if the air conditioner or heat pump in operation generates unusual noise.
- Make sure that the drainpipe is installed properly to drain water. If no water is discharged from the drainpipe while the air conditioner or heat pump is in the cooling mode, the drainpipe may be clogged with dust or dirt and water leakage from the indoor unit may occur. Stop operating the air conditioner or heat pump and contact your dealer.
- Do not spray the air conditioner unit with any deodorizers, etc. It may cause the unit to malfunction.

FTP002M-U

# Names of Parts

## Indoor Unit

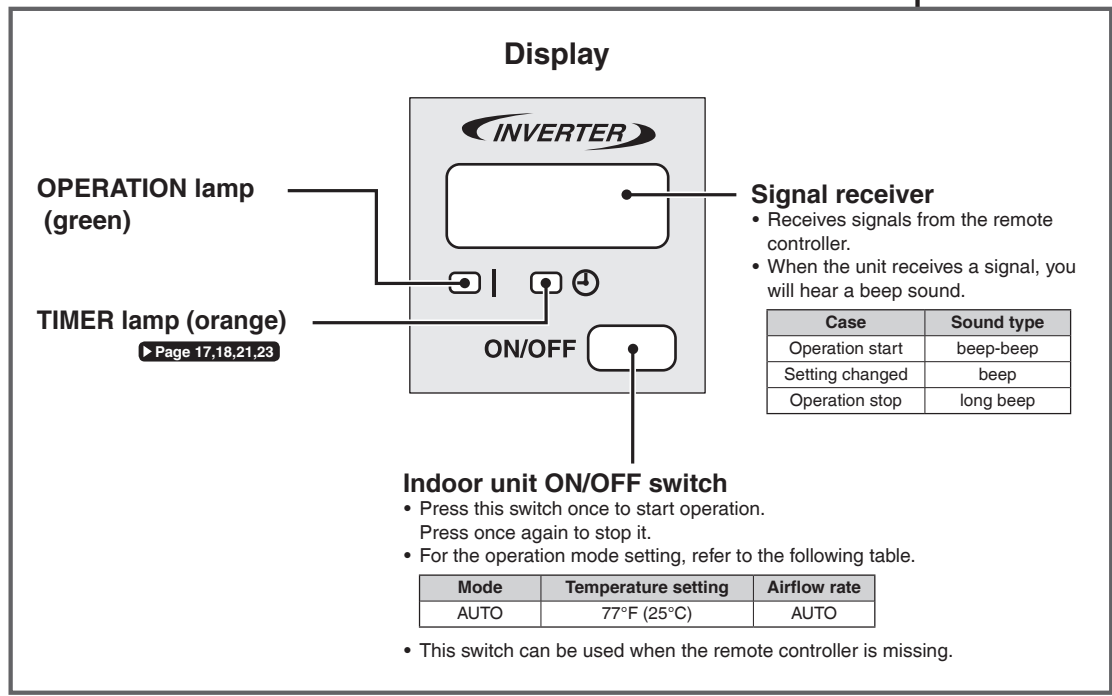
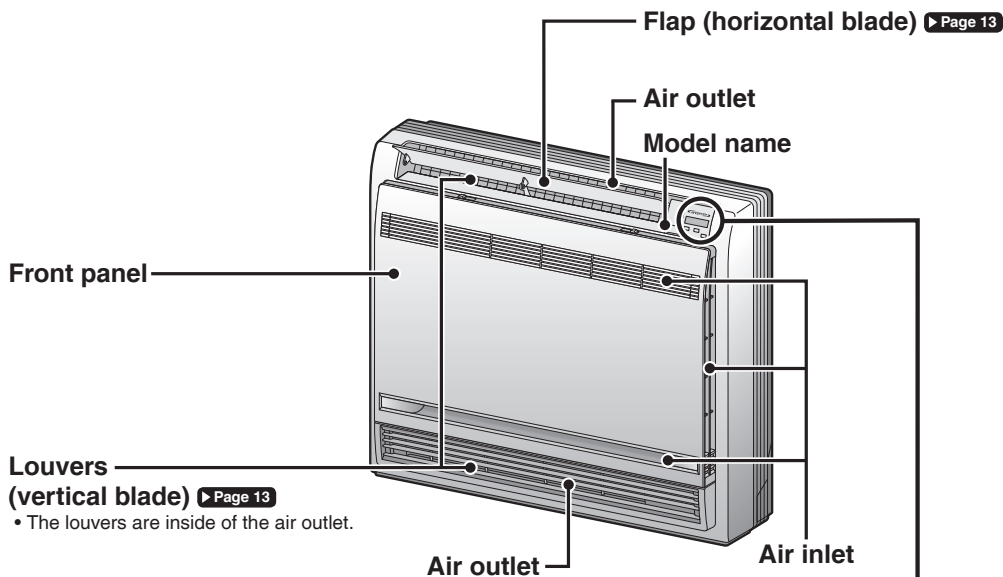

### ■ Open the front panel

- How to open the front panel: ▶ Page 28

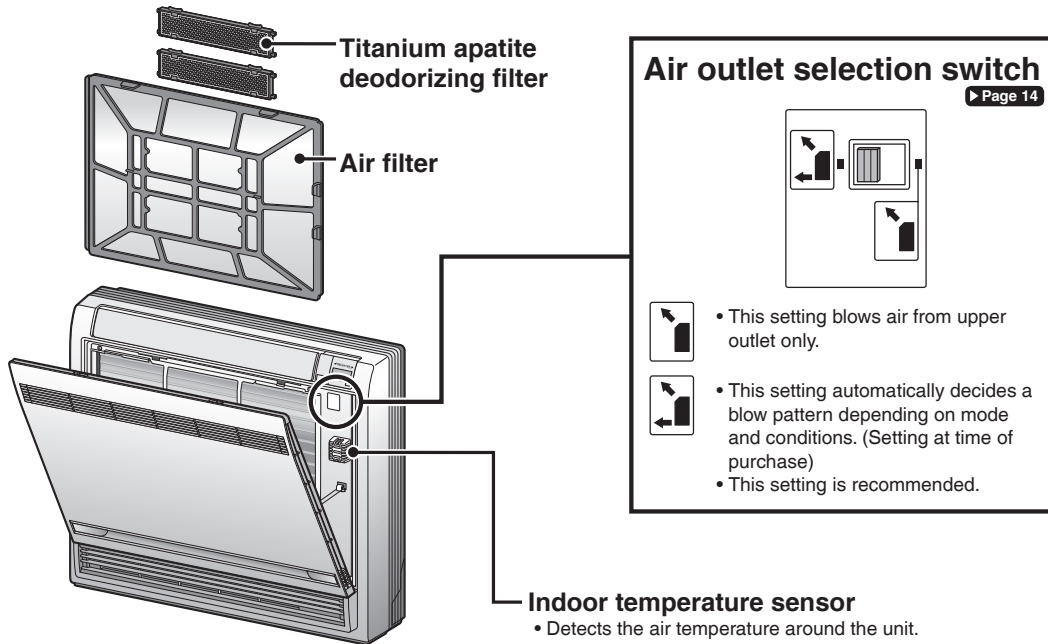

### Outdoor Unit

- The appearance of the outdoor unit may differ between different models.

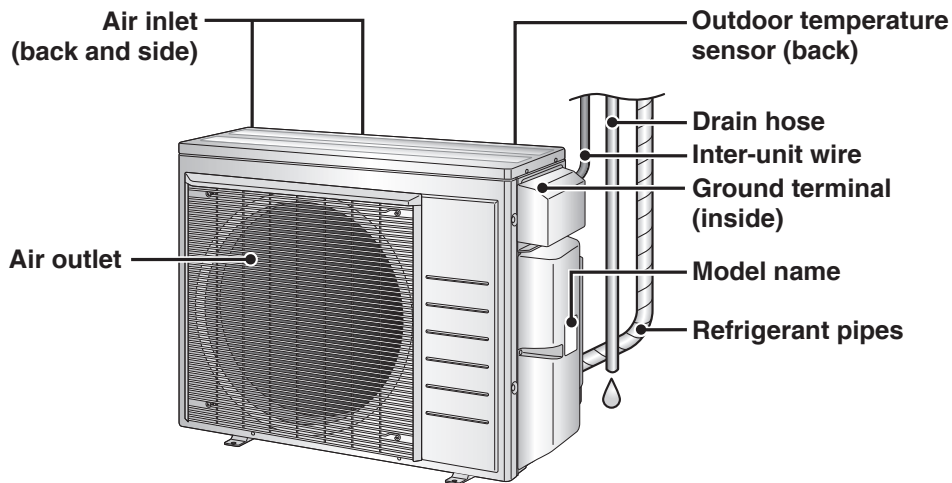

# Names of Parts

## Remote Controller

### Signal transmitter

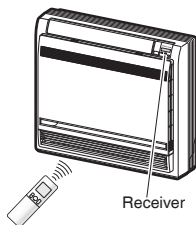

- To use the remote controller, aim the transmitter at the indoor unit. If there is anything blocking the signals between the unit and the remote controller, such as a curtain, the unit may not operate.
- The maximum transmission distance is about 23ft (7m).

### FAN setting button

- Selects the airflow rate setting. [▶ Page 12](#)

### POWERFUL button

- POWERFUL operation. [▶ Page 15](#)

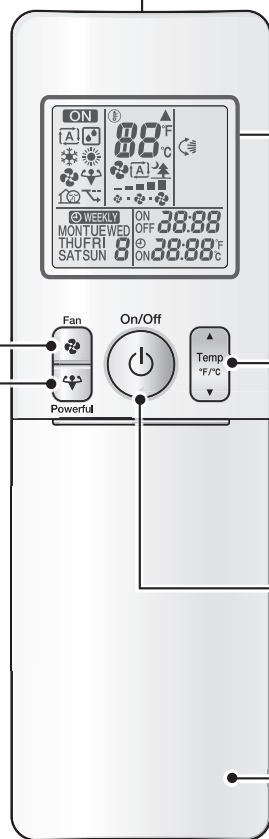

### Display (LCD)

- Displays the current settings. (In this illustration, each section is shown with all its displays on for the purpose of explanation.)

### TEMPERATURE adjustment button

- Changes the temperature setting. [▶ Page 11](#)

### ON/OFF button

- Press this button once to start operation. Press once again to stop it. [▶ Page 11](#)

### Front cover

- Open the front cover. [▶ Page 8](#)

Model	ARC466A21
-------	-----------



■ Open the front cover

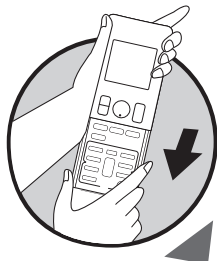

**MODE selector button**  
• Selects the operation mode.  
(AUTO/DRY/COOL/HEAT/FAN)  
▶ Page 11

**ECONO button**  
• ECONO operation. ▶ Page 15

**SWING button**  
• Adjusts the airflow direction.  
▶ Page 13

**QUIET button**  
• QUIET OUTDOOR UNIT operation.  
▶ Page 16

**OFF TIMER button (NIGHT SET mode)**  
▶ Page 18

**TIMER CANCEL button**  
• Cancels the timer setting.  
▶ Page 17,18  
• Cannot be used for the WEEKLY TIMER operation.

Weekly [ ] : WEEKLY button  
[ ] : PROGRAM button  
Copy [ ] : COPY button  
Back [ ] : BACK button  
Next [ ] : NEXT button  
• WEEKLY TIMER operation.  
▶ Page 19

**SELECT button**  
• Changes the clock, ON/OFF TIMER and WEEKLY TIMER settings.

**ON TIMER button**  
▶ Page 17

**CLOCK button** ▶ Page 10

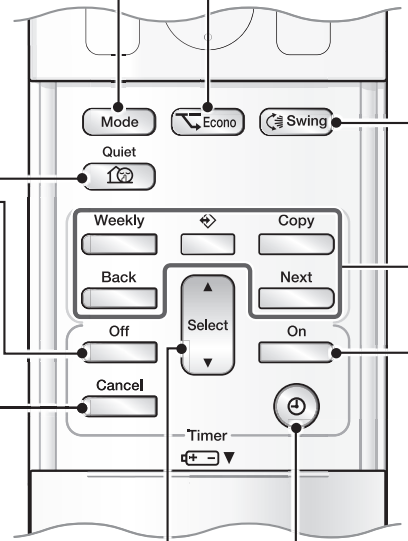

# Preparation Before Operation

## To insert the batteries

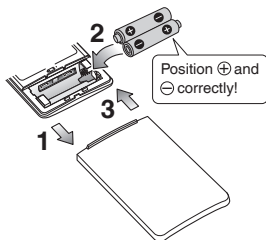

- 1.** Slide the front cover to take it off.
- 2.** Insert 2 dry batteries AAA.LR03 (alkaline).
- 3.** Replace the front cover.

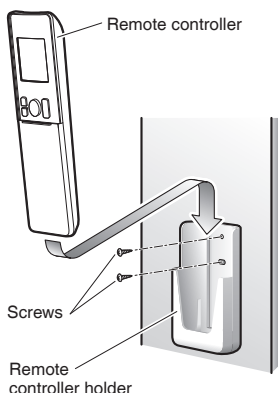

## To fix the remote controller holder to a wall

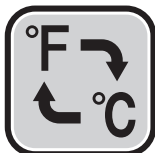

- 1.** Choose a place where the signals reach the unit.
- 2.** Attach the holder to a wall, a pillar, or similar location with the screws supplied with the holder.
- 3.** Place the remote controller in the remote controller holder.

## Fahrenheit/Celsius display switch



Press  and  (TIMER button) simultaneously for about 5 seconds.

- The temperature will be displayed in Celsius when it is presently displayed in Fahrenheit, and vice versa.
- The switch operation is only possible when the temperature is being displayed.

### NOTE

#### Notes on batteries

- When replacing the batteries, use batteries of the same type, and replace both old batteries together.
- The batteries will last for about 1 year. However, if the remote controller display begins to fade and the possible transmission range becomes shorter within a year, replace both batteries with new, size AAA.LR03 (alkaline) batteries.
- The batteries supplied with the remote controller are for initial operation. The batteries may run out in less than 1 year.

#### Note on remote controller

- Do not drop the remote controller. Do not get it wet.

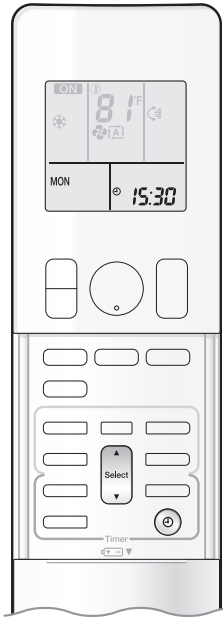

**Turn on the circuit breaker**

- After the power is turned on, the flaps of the indoor unit open and close once to set the reference position.

**To set the clock**

**1. Press**  .



“0:00” is displayed on the LCD.  
“MON” and “” blink.

**2. Press**  **to set the current day of the week.**

**3. Press**  .



“” blinks.

**4. Press**  **to set the clock to the present time.**

- Holding down  or  rapidly increases or decreases the displayed time.

**5. Press**  .

- Point the remote controller at the indoor unit when pressing the buttons.



“.” blinks.

**NOTE**

**Fahrenheit/Celsius display change function of remote controller**

- The set temperature may increase when the display is changed to Celsius from Fahrenheit, because a fraction of 0.5°C is rounded up.
- Example: A set temperature of 65°F (equivalent to 18.5°C) will be converted into 19°C.  
When the display is changed to Fahrenheit again, the set temperature will be converted into 66°F (equivalent to 19°C) instead of the original set temperature (65°F) but a set temperature of 66°F (equivalent to 19°C) will be converted into 19°C with no temperature change.
- A reception sound will go off for the transmission of set temperature to the indoor unit at the time of setting the Fahrenheit/Celsius display change function.

**Note on setting the clock**

- If the indoor unit's internal clock is not set to the correct time, the ON/OFF TIMER and WEEKLY TIMER will not operate punctually.



# AUTO · DRY · COOL · HEAT · FAN Operation



The air conditioner operates with the operation mode of your choice. From the next time on, the air conditioner will operate with the same operation mode.

## To start operation

### 1. Press and select an operation mode.

- Each pressing of the button changes the mode setting in sequence.

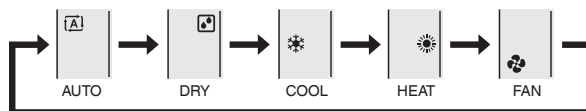

### 2. Press .

- “**ON**” is displayed on the LCD.
- The OPERATION lamp lights green.

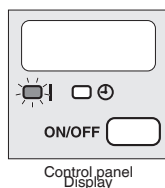

## To stop operation

### Press again.

- “**ON**” disappears from the LCD.
- The OPERATION lamp goes off.

## To change the temperature setting

### Press .

- Press ▲ to raise the temperature and press ▼ to lower the temperature.

COOL operation	HEAT operation	AUTO operation	DRY or FAN operation
64-90°F (18-32°C)	50-86°F (10-30°C)	64-86°F (18-30°C)	The temperature setting cannot be changed.

## NOTE

### Notes on AUTO operation

- In AUTO operation, the system selects an appropriate operation mode (COOL or HEAT) based on the indoor temperature and starts the operation.
- The system automatically reselects setting at a regular interval to bring the indoor temperature to the user-setting level.

### Note on DRY operation

- Eliminates humidity while maintaining the indoor temperature as much as possible. It automatically controls temperature and airflow rate, so manual adjustment of these functions is unavailable.



# Adjusting the Airflow Rate

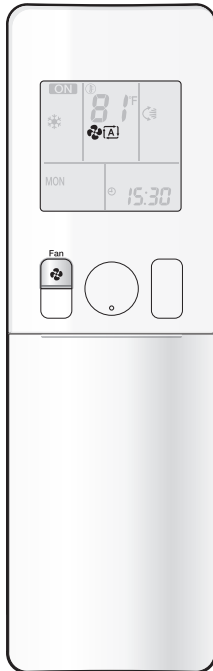



You can adjust the airflow rate to increase your comfort.



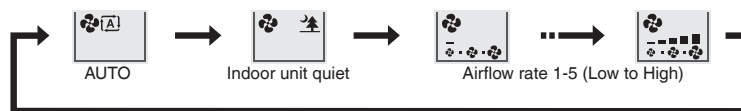

## To adjust the airflow rate setting

Press .

- Each pressing of  changes the airflow rate setting in sequence.



- When the airflow is set to “”, quiet operation starts and noise from the indoor unit will become quieter.
- In the quiet operation mode, the airflow rate is set to a weak level.

AUTO, COOL, HEAT and FAN operation	DRY operation
   	 <p>The airflow rate setting cannot be changed.</p>

## NOTE

### Note on airflow rate setting

- At smaller airflow rates, the cooling (heating) effect is also smaller.

## Tips for saving energy

### Keeping the temperature setting at a moderate level helps save energy.

- Recommended temperature setting
  - For cooling: 78-82°F (26-28°C)
  - For heating: 68-75°F (20-24°C)

### Cover windows with a blind or a curtain.

- Blocking sunlight and air from outdoors increases the cooling (heating) effect.

### Keep the air filter clean.

- A clogged air filter causes inefficient operation and wastes energy. Clean it once every 2 weeks. [▶ Page 29](#)

### If you are not going to use the air conditioner for a long period, for example in spring or autumn, turn off the circuit breaker.

- The air conditioner always consumes a small amount of electricity even while it is not operating.





## Adjusting the Airflow Direction



You can adjust the airflow direction to increase your comfort.

### CAUTION

- Always use a remote controller to adjust the angles of the flap. Moving the flap forcibly by hand may cause a malfunction.
- Be careful when adjusting the louvers. Inside the air outlet, a fan is rotating at a high speed.

### To start auto swing

#### Up and down airflow direction

Press .

- “” is displayed on the LCD.
- The flaps (horizontal blades) will begin to swing.

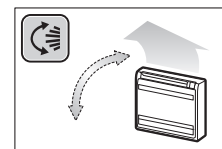

### To set the flap at the desired position

- This function is effective while the flap is in auto swing mode.

Press when the flap reaches the desired position.

- “” disappears from the LCD.

### To adjust the louvers at desired position

Hold the knobs and move the louvers (vertical blades).

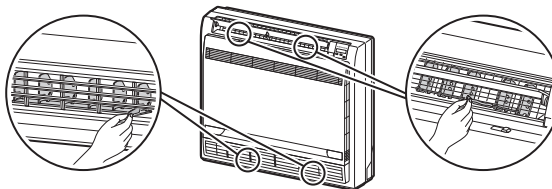

### NOTE

#### Note on airflow direction setting

- The movable range of the flap varies according to the operation mode.
- Unless “Swing” is selected, you should set the flap at a near-horizontal angle in FAN or HEAT operation and at an upward position in COOL or DRY operation to obtain the best performance.

Movable range of the flap

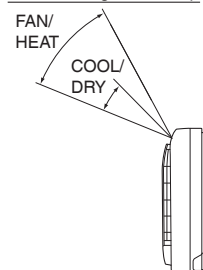







### Air outlet selection

- Make air outlet selection according to what suits you. [▶ Page 6](#)

#### When setting the air outlet selection switch to

- Air conditioner automatically decides the appropriate blowing pattern depending on the operating mode/situation.

Mode	Situation	Blowing pattern	
COOL (❄️)	When the operation is activated or when the room is not fully cooled.		Air is emitted from the upper and lower air outlets in order to reach the set temperature quickly.
	When the room has become fully cool, or when 1 hour has passed since turning on the air conditioner.		Air is emitted only from the upper air outlet so that air does not come into direct contact with people and indoor temperature is equalized.
HEAT (🔥)	When the operation is activated or when air emitted is of low temperature.		Air is emitted only from the upper air outlet so that air does not come into direct contact with people.
	At times other than the above situations.		Air is emitted from the upper and lower air outlets so that warm air is spread throughout the whole room.
DRY (☞)	Whenever in DRY mode.		Air is emitted only from the upper air outlet so that air does not come into direct contact with people.
FAN (🌀)	Whenever in FAN mode.		
AUTO (Ⓐ)	Operates in the actual operation mode of the air conditioner according to the descriptions in this table. (COOL or HEAT)		

#### When setting the air outlet selection switch to

- Regardless of the operating mode or situation, air is emitted from the upper air outlet.
- Use this switch when you do not want air coming out of the lower air outlet. (While sleeping, etc.)



## POWERFUL Operation

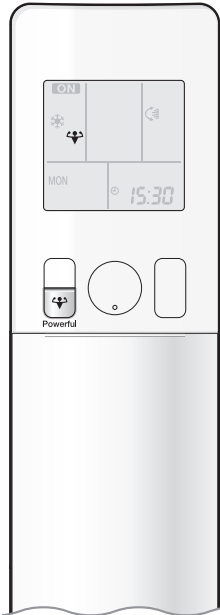

POWERFUL operation quickly maximizes the cooling (heating) effect in any operation mode. In this mode, the air conditioner operates at maximum capacity.

### To start POWERFUL operation

Press  during operation.

- “” is displayed on the LCD.
- POWERFUL operation ends in 20 minutes. Then the system automatically operates again with the previous settings which were used before POWERFUL operation.

### To cancel POWERFUL operation

Press  again.

- “” disappears from the LCD.



## ECONO Operation

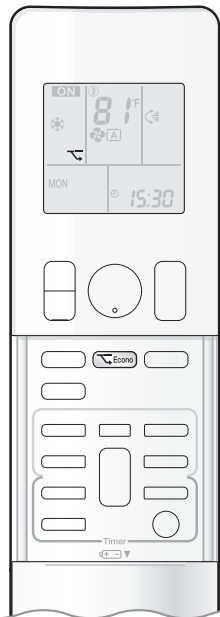

ECONO operation enables efficient operation by limiting the maximum power consumption.

This function is useful to prevent the circuit breaker from tripping when the unit operates alongside other appliances on the same circuit.

### To start ECONO operation

Press  during operation.

- “” is displayed on the LCD.
- Not available in FAN ONLY mode.

### To cancel ECONO operation

Press  again.

- “” disappears from the LCD.





# QUIET OUTDOOR UNIT Operation

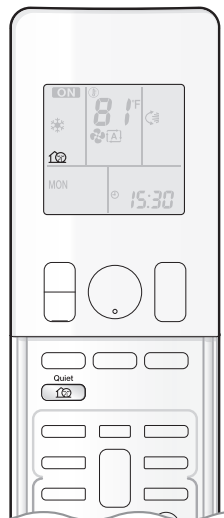

QUIET OUTDOOR UNIT operation lowers the noise level of the outdoor unit by changing the frequency and fan speed of the outdoor unit. This function is convenient during the night-time operation.

## To start QUIET OUTDOOR UNIT operation

Press .

- “” is displayed on the LCD.

## To cancel QUIET OUTDOOR UNIT operation

Press again.

- “” disappears from the LCD.

### NOTE

#### Notes on POWERFUL operation

- Pressing causes the settings to be canceled, and “” disappears from the LCD.
- POWERFUL operation will not increase the capacity of the air conditioner if the air conditioner is already in operation with its maximum capacity demonstrated.
  - In COOL, HEAT and AUTO operation  
To maximize the cooling (heating) effect, the capacity of outdoor unit increases and the airflow rate becomes fixed at the maximum setting. The temperature setting cannot be changed.
  - In DRY operation  
The temperature setting is lowered by 4.5°F (2.5°C) and the airflow rate is slightly increased.
  - In FAN ONLY operation  
The airflow rate is fixed at the maximum setting.
  - When using priority room setting  
Refer to “Note for Multi System”. ▶ Page 25

#### Notes on ECONO operation

- Pressing causes the settings to be canceled, and “” disappears from the LCD.
- If the power consumption level is already low, switching to ECONO operation will not reduce the power consumption.

#### Notes on QUIET OUTDOOR UNIT operation

- If using a multi system, the QUIET OUTDOOR UNIT operation will work only when this function is set on all operated indoor units. However, if using priority room setting, refer to “Note for Multi System”. ▶ Page 25
- Even if the operation is stopped by using the remote controller or the indoor unit ON/OFF switch when using QUIET OUTDOOR UNIT operation, “” will remain displayed on the remote controller.
- QUIET OUTDOOR UNIT operation will not reduce the frequency nor fan speed if they already are operating at reduced levels.
- This operation is performed with lower power and therefore may not provide a sufficient cooling (heating) effect.

#### Possible combinations of ECONO / QUIET OUTDOOR UNIT operation and basic operations

	Operation mode				
	AUTO	DRY	COOL	HEAT	FAN
ECONO	✓	✓	✓	✓	—
QUIET OUTDOOR UNIT	✓	—	✓	✓	—

Some useful functions can be used together.

QUIET OUTDOOR UNIT + ECONO	Available
POWERFUL + QUIET OUTDOOR UNIT	Not available*
POWERFUL + ECONO	Not available*

\*Priority is given to the function of whichever button is pressed last.



# ON/OFF TIMER Operation

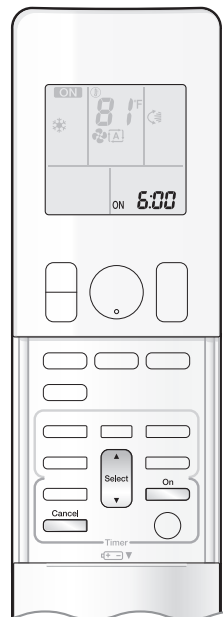

Timer functions are useful for automatically switching the air conditioner on or off at night or in the morning. You can also use the ON TIMER and OFF TIMER together.

## To use ON TIMER operation

- Check that the clock is correct.  
If not, set the clock to the present time. ▶Page 10

**1. Press** .

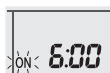

“6:00” is displayed on the LCD.  
“ON” blinks.

- “☀” and day of the week disappear from the LCD.

**2. Press** **until the time setting reaches the point you like.**

- Each pressing of either button increases or decreases the time setting by 10 minutes.  
Holding down either button changes the setting rapidly.

**3. Press** **again.**

- “ON” and setting time are displayed on the LCD.
- The TIMER lamp lights orange.

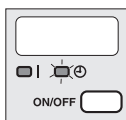

Display

## To cancel ON TIMER operation

**Press** .

- “ON” and setting time disappear from the LCD.
- “☀” and day of the week are displayed on the LCD.
- The TIMER lamp goes off.

### NOTE

#### Notes on TIMER operation

- When TIMER is set, the present time is not displayed.
- When using the ON/OFF TIMER to start/stop operation, the actual operation start/stop time may differ from the time set. (Maximum of about 10 minutes)

#### In the following cases, set the timer again.

- After the circuit breaker has turned off.
- After a power failure.
- After replacing the batteries in the remote controller.

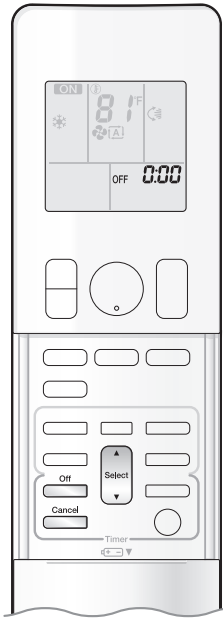

### To use OFF TIMER operation

- Check that the clock is correct.  
If not, set the clock to the present time. ▶ Page 10

#### 1. Press .



“ 0:00 ” is displayed on the LCD.  
“ OFF ” blinks.

- “ ☉ ” and day of the week disappear from the LCD.

#### 2. Press until the time setting reaches the point you like.

- Each pressing of either button increases or decreases the time setting by 10 minutes.  
Holding down either button changes the time setting rapidly.

#### 3. Press again.

- “ OFF ” and setting time are displayed on the LCD.
- The TIMER lamp lights orange.

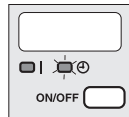

Display

### To cancel OFF TIMER operation

#### Press .

- “ OFF ” and setting time disappear from the LCD.
- “ ☉ ” and day of the week are displayed on the LCD.
- The TIMER lamp goes off.

### To combine ON TIMER and OFF TIMER operation

- A sample setting for combining the 2 timers is shown below.

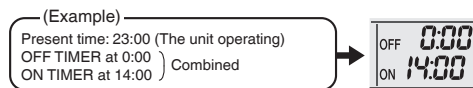

### NOTE

#### NIGHT SET mode

- When the OFF TIMER is set, the air conditioner automatically adjusts the temperature setting (0.9°F (0.5°C) up in COOL, 3.6°F (2.0°C) down in HEAT) to prevent excessive cooling (heating) during sleeping hours.



# WEEKLY TIMER Operation

Up to 4 timer settings can be saved for each day of the week. This is convenient to adapt the WEEKLY TIMER to your family's lifestyle.

## Setting example of the WEEKLY TIMER

The same timer settings are used from Monday through Friday, while different timer settings are used for the weekend.

<p><b>[Monday]</b></p>	<p>Make timer settings for programs 1-4. ▶ Page 20</p>
<p><b>[Tuesday] to [Friday]</b></p>	<p>Use the copy mode to make settings for Tuesday to Friday, because these settings are the same as those for Monday. ▶ Page 22</p>
<p><b>[Saturday]</b></p>	<p>No timer settings</p>
<p><b>[Sunday]</b></p>	<p>Make timer settings for programs 1-4. ▶ Page 20</p>

- Up to 4 reservations per day and 28 reservations per week can be set using the WEEKLY TIMER. The effective use of the copy mode simplifies timer programming.
- The use of ON-ON-ON-ON settings, for example, makes it possible to schedule operating mode and set temperature changes. Furthermore, by using OFF-OFF-OFF-OFF settings, only the turn off time of each day can be set. This will turn off the air conditioner automatically if you forget to turn it off.

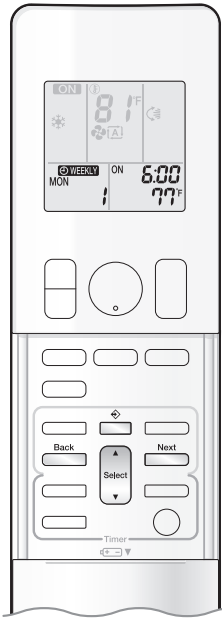

**To use WEEKLY TIMER operation**

**Setting mode**

- Make sure the day of the week and time are set.  
If not, set the day of the week and time. ▶ **Page 10**

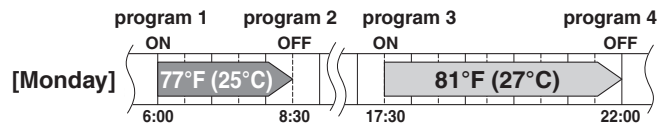

**Setting Displays**

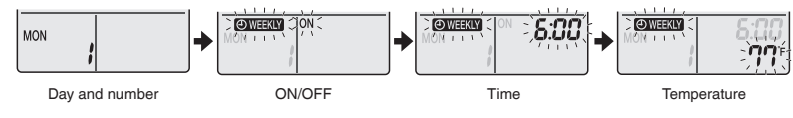

**1. Press [Up Arrow].**

- The day of the week and the reservation number of the current day will be displayed.
- 1 to 4 settings can be made per day.

**2. Press [Select] to select the desired day of the week and reservation number.**

- Pressing [Select] changes the reservation number and the day of the week.

**3. Press [Next].**

- The day of the week and reservation number will be set.
- "WEEKLY" and "ON" blink.

**4. Press [Select] to select the desired mode.**

- Pressing [Select] changes the "ON" or "OFF" setting in sequence.



- In case the reservation has already been set, selecting "blank" deletes the reservation.
- Proceed to **STEP 9** if "blank" is selected.
- To return to the day of the week and reservation number setting, press [Back].

**5. Press [Next].**

- The ON/OFF TIMER mode will be set.
- "WEEKLY" and the time blink.



# WEEKLY TIMER Operation

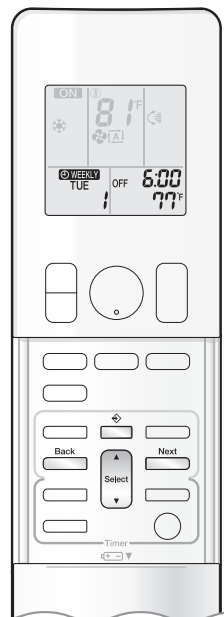



## 6. Press to select the desired time.

- The time can be set between 0:00 and 23:50 in 10-minute intervals.
- To return to the ON/OFF TIMER mode setting, press  .
- Proceed to **STEP 9** when setting the OFF TIMER.

## 7. Press .

- The time will be set.
- “  ” and the temperature blink.

## 8. Press to select the desired temperature.

- The temperature can be set between 50°F (10°C) and 90°F (32°C).  
COOL or AUTO: The unit operates at 64°F (18°C) even if it is set at 50°F (10°C) to 63°F (17°C).  **Page 11**  
HEAT or AUTO : The unit operates at 86°F (30°C) even if it is set at 87°F (31°C) to 90°F (32°C).  **Page 11**
- To return to the time setting, press  .
- The set temperature is only displayed when the mode setting is on.

## 9. Press .

- The temperature will be set and go to the next reservation setting.
- The temperature is set while in ON TIMER operation, and the time is set while in OFF TIMER operation.
- The next reservation screen will appear.
- To continue further settings, repeat the procedure from **STEP 4**.

## 10. Press to complete the setting.

- Be sure to direct the remote controller toward the indoor unit and check for a receiving tone and blinking of the OPERATION lamp.
- “  ” is displayed on the LCD and WEEKLY TIMER operation is activated.
- The TIMER lamp lights orange.

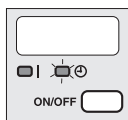





Display

- A reservation made once can be easily copied and the same settings used for another day of the week. Refer to **Copy mode** .  **Page 22**

### NOTE

#### Notes on WEEKLY TIMER operation

- Do not forget to set the clock on the remote controller first.  **Page 10**
- The day of the week, ON/OFF TIMER mode, time and set temperature (only for ON TIMER mode) can be set with the WEEKLY TIMER. Other settings for the ON TIMER are based on the settings just before the operation.
- WEEKLY TIMER and ON/OFF TIMER operation cannot be used at the same time. The ON/OFF TIMER operation has priority if it is set while WEEKLY TIMER is still active. The WEEKLY TIMER will enter the standby state, and “  ” will disappear from the LCD. When the ON/OFF TIMER is up, the WEEKLY TIMER will automatically become active.
- Only the time and set temperature with the WEEKLY TIMER are sent with the  . Set the WEEKLY TIMER only after setting the operation mode, the airflow rate and the airflow direction ahead of time.
- Turning off the circuit breaker, power failure, and other similar events will render operation of the indoor unit's internal clock inaccurate. Reset the clock.  **Page 10**
-  can be used only for the time and temperature settings. It cannot be used to go back to the reservation number.

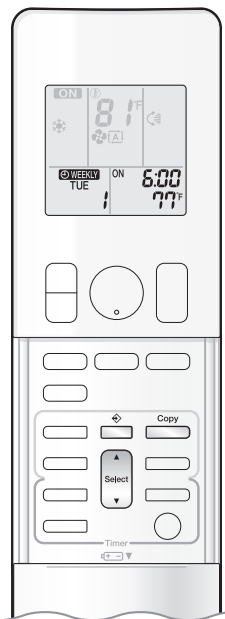

**Copy mode**

- A reservation made once can be copied to another day of the week. The whole reservation of the selected day of the week will be copied.

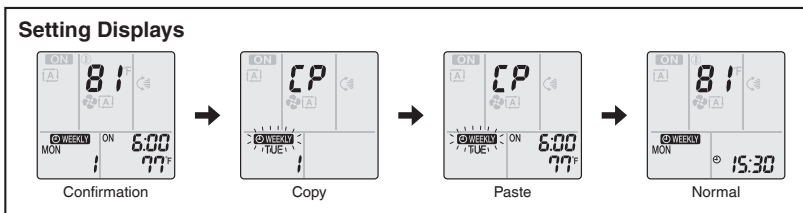
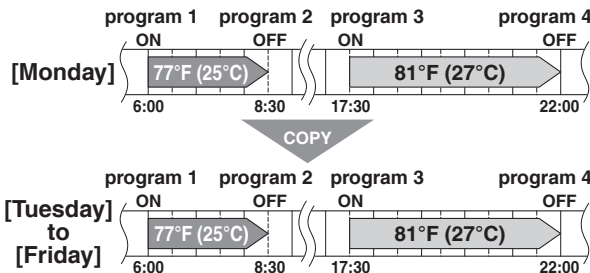

1. Press .
2. Press to confirm the day of the week to be copied.
3. Press .
  - The whole reservation of the selected day of the week will be copied.
4. Press to select the destination day of the week.
5. Press .
  - The reservation will be copied to the selected day of the week. The whole reservation of the selected day of the week will be copied.
  - To continue copying the settings to other days of the week, repeat **STEP 4** and **STEP 5**.
6. Press to complete the setting.
  - " WEEKLY " is displayed on the LCD and WEEKLY TIMER operation is activated.

**NOTE**

**Note on COPY MODE**

- The entire reservation of the source day of the week is copied in the copy mode.
- In the case of making a reservation change for any day of the week individually after copying the content of weekly reservations, press and change the settings in the steps of **Setting mode** **Page 20**



# WEEKLY TIMER Operation

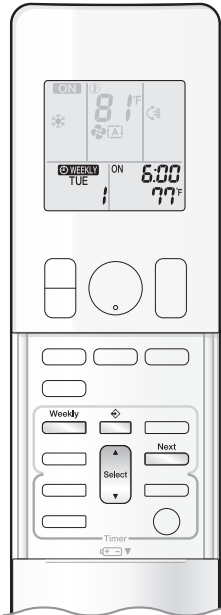

## Confirming a reservation

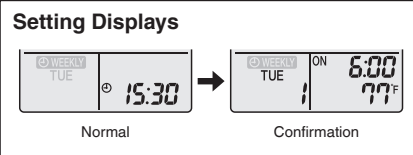

- The reservation can be confirmed.



### 1. Press .

- The day of the week and the reservation number of the current day will be displayed.

### 2. Press to select the day of the week and the reservation number to be confirmed.

- Pressing  displays the reservation details.
- To change the confirmed reserved settings, select the reservation number and press . The mode is switched to setting mode. Proceed to **Setting mode STEP 4.** [▶Page 20](#)

### 3. Press to exit the confirmation mode.

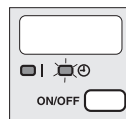

- “ WEEKLY” is displayed on the LCD and WEEKLY TIMER operation is activated.
- The TIMER lamp lights orange.



Display

## To deactivate WEEKLY TIMER operation

### Press while “ WEEKLY” is displayed on the LCD.

- “ WEEKLY” disappears from the LCD.
- The TIMER lamp goes off.
- To reactivate the WEEKLY TIMER operation, press  again.
- If a reservation deactivated with  is activated once again, the last reservation mode will be used.

## NOTE

- If not all the reservation settings are reflected, deactivate the WEEKLY TIMER operation once. Then press  again to reactivate the WEEKLY TIMER operation.



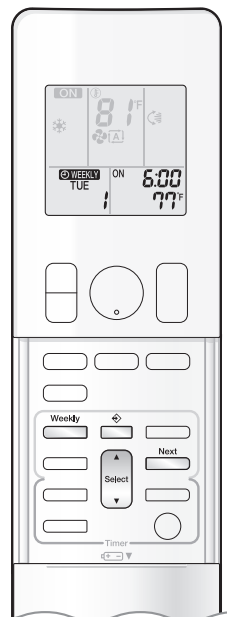

**To delete reservations**

**An individual reservation**

- 1. Press** .  
 • The day of the week and the reservation number will be displayed.
- 2. Press** **to select the day of the week and the reservation number to be deleted.**
- 3. Press** .  
 • “ WEEKLY” and “ON” or “OFF” blink.
- 4. Press** **until no icon is displayed.**  
 • Pressing changes the ON/OFF TIMER mode in sequence.  
 • Selecting “blank” will cancel any reservation you may have.



- 5. Press** .  
 • The selected reservation will be deleted.
- 6. Press** .  
 • If there are still other reservations, WEEKLY TIMER operation will be activated.

**Reservations for each day of the week**

- This function can be used for deleting reservations for each day of the week.
  - It can be used while confirming or setting reservations.
- 1. Press** .  
 • The day of the week and the reservation number will be displayed.
  - 2. Press** **to select the day of the week to be deleted.**
  - 3. Hold** **for about 5 seconds.**  
 • The reservation of the selected day of the week will be deleted.
  - 4. Press** .  
 • If there are still other reservations, WEEKLY TIMER operation will be activated.

**All reservations**

- **Hold** **for about 5 seconds with the normal display.**
  - Be sure to direct the remote controller toward the indoor unit and check for a receiving tone.
  - This operation cannot be used for the WEEKLY TIMER setting display.
  - All reservations will be deleted.

## Note for Multi System

A multi system has one outdoor unit connected to multiple indoor units.

### Selecting the operation mode

**When the priority room setting is active but the set unit is not operating or when the priority room setting is inactive**

When more than one indoor unit is operating, priority is given to the first unit that was turned on.

In this case, set the units that are turned on later to the same operation mode as the first unit.

Otherwise, they will enter the standby state, and the OPERATION lamp will blink; this does not indicate malfunction.

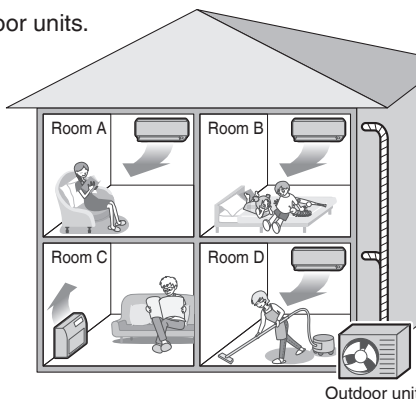

### NOTE

#### Notes on operation mode for a multi system

- COOL, DRY and FAN operation may be used at the same time.
- AUTO operation automatically selects COOL operation or HEAT operation based on the indoor temperature. Therefore, AUTO operation is available when selecting the same operation mode as that of the room with the first unit to be turned on.

### CAUTION

- Normally, the operation mode in the room where the unit is first started is given priority, but the following situations are exceptions to this rule. If the operation mode of the first room is FAN operation, then using HEAT operation in any room after this will give priority to HEAT operation. In this situation, the indoor unit operating in FAN mode will switch to standby, and the OPERATION lamp will blink.

#### With the priority room setting active

Refer to “Priority room setting” on the next page.

### NIGHT QUIET operation (Available only for COOL operation)

NIGHT QUIET operation requires initial programming during installation. Please consult your retailer or dealer for assistance. NIGHT QUIET operation reduces the operation noise of the outdoor unit during the night-time hours to prevent annoyance to neighbors.

- NIGHT QUIET operation is activated when the temperature drops 10.8°F (6°C) or more below the highest temperature recorded that day. When the temperature difference between the current outdoor temperature and the maximum outdoor temperature becomes less than 7.2°F (4°C), this function will be canceled.
- NIGHT QUIET operation slightly reduces the cooling efficiency of the unit.

### QUIET OUTDOOR UNIT operation

Refer to “QUIET OUTDOOR UNIT Operation”. ▶ Page 16

**When the priority room setting is active but the set unit is not operating or when the priority room setting is inactive**

When using the QUIET OUTDOOR UNIT operation feature with a multi system, set all indoor units to QUIET OUTDOOR UNIT operation using their remote controllers.

When canceling QUIET OUTDOOR UNIT operation, simply cancel the mode on one of the operating indoor units using their remote controller.

However QUIET OUTDOOR UNIT operation will remain displayed on the remote controllers for the other rooms.

We recommend you cancel operation in all rooms using their remote controllers.

#### With the priority room setting active

Refer to “Priority room setting” on the next page.

### COOL/HEAT mode lock

The COOL/HEAT mode lock requires initial programming during installation. Please consult your authorized dealer for assistance. The COOL/HEAT mode lock sets the unit forcibly to either COOL or HEAT operation. This function is convenient when you wish to set all indoor units connected to the multi system to the same operation mode.

#### NOTE

- The COOL/HEAT mode lock cannot be activated together with the priority room setting.

### Priority room setting

The priority room setting requires initial programming during installation. Please consult your authorized dealer for assistance. The room designated as the priority room takes priority in the following situations.

#### Operation mode priority

- As the operation mode of the priority room takes precedence, you can select a different operation mode from other rooms.

#### [Example]

- Room A is the priority room in this examples.  
When COOL operation is selected in room A while operating the following modes in room B, C and D:

Operation mode in room B, C and D	Status of room B, C and D when the unit in room A is in COOL operation
COOL or DRY or FAN	The current operation mode is maintained.
HEAT	The unit enters the standby mode. Operation resumes when the room A unit stops operating.
AUTO	If the unit is set to COOL operation, it continues. If the unit is set to HEAT operation, it enters the standby mode. Operation resumes when the room A unit stops operating.

#### Priority when POWERFUL operation is used

#### [Example]

- Room A is the priority room in this examples.  
The indoor units in rooms A, B, C and D are all operating. If the unit in room A enters POWERFUL operation, operation capacity will be concentrated in room A. In such a case, the cooling (heating) efficiency of the units in room B, C and D may be slightly reduced.

#### Priority when QUIET OUTDOOR UNIT operation is used

#### [Example]

- Room A is the priority room in this examples.  
Just by setting the unit in room A to QUIET operation, the air conditioner starts QUIET OUTDOOR UNIT operation. You do not have to set all the indoor units in operation to QUIET OUTDOOR UNIT operation.

# Care and Cleaning

## ⚠ CAUTION

- Before cleaning, be sure to stop the operation and turn off the circuit breaker.
- Do not touch the aluminum fins of the indoor unit. If you touch those parts, this may cause an injury.

### ■ Quick reference

#### Cleaning parts

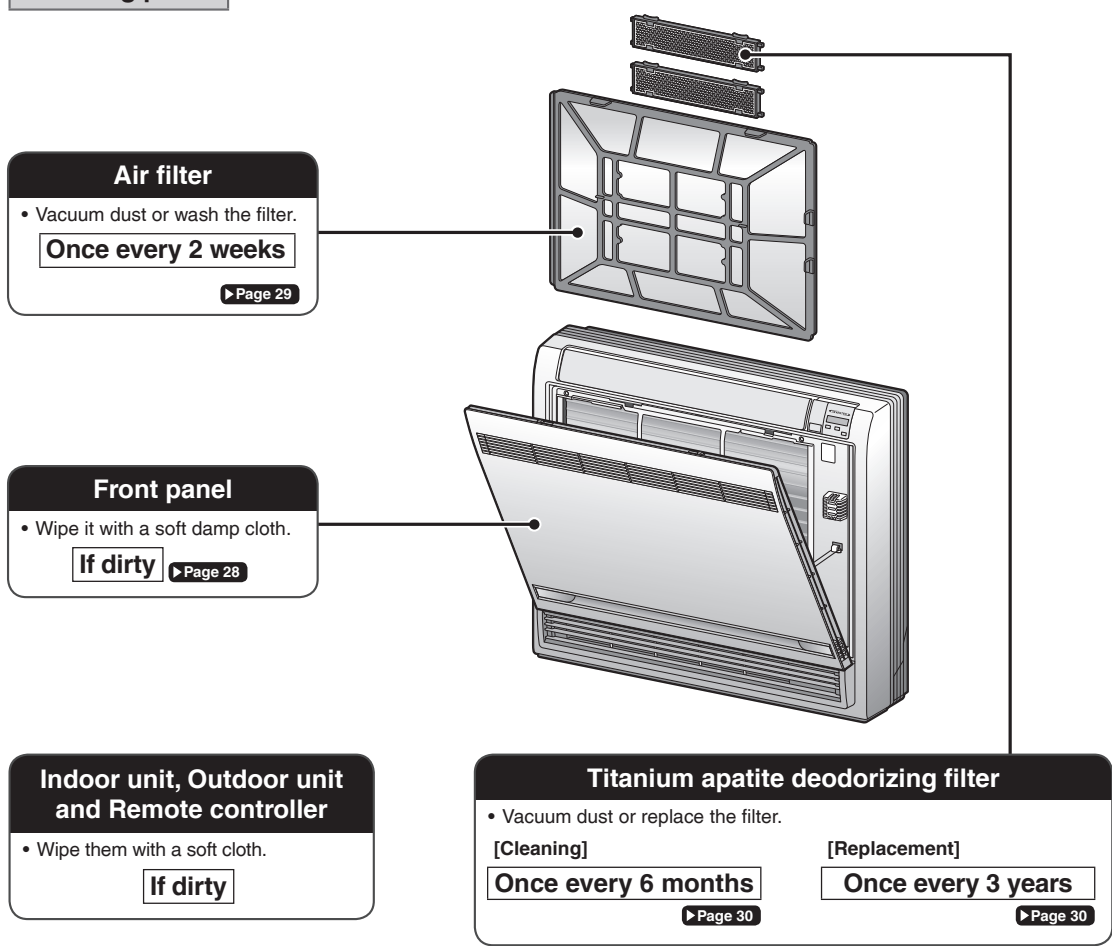

#### Notes on cleaning

**For cleaning, do not use any of the following:**

- Water hotter than 104°F (40°C)
- Volatile liquid such as benzene, petrol and thinner
- Polishing compounds
- Rough materials such as a scrubbing brush
- Sprays such as deodorizers



**⚠ CAUTION**

- When removing or attaching the front panel, stand on solid ground and use caution.
- When removing or attaching the front panel, support the panel securely with your hand to prevent it from falling.

**■ Front panel**

**1. Open the front panel.**

- Slide the 2 stoppers on the left and right sides inward until they click.

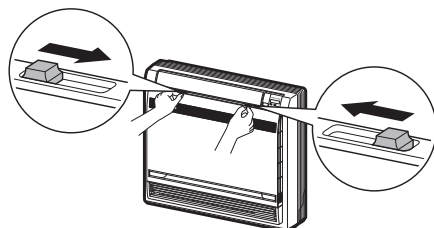

**2. Remove the front panel.**

- Remove the string.
- Allowing the front panel to fall forward will enable you to remove it.
- Disconnect the front panel hooks from the grooves.

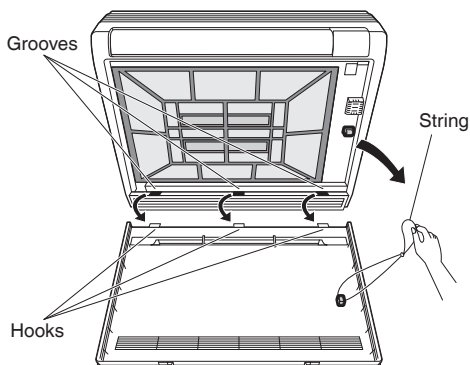

**3. Clean the front panel.**

- Wipe it with a soft damp cloth.
- Only neutral detergent may be used.
- Wash the panel with water, wipe it with a dry soft cloth, and let it dry in the shade after washing.

**4. Reattach the front panel.**

- Insert the front panel hooks into the grooves of the unit (3 places).
- Attach the string to the right, inner-side of the front grille.
- Close the panel slowly.

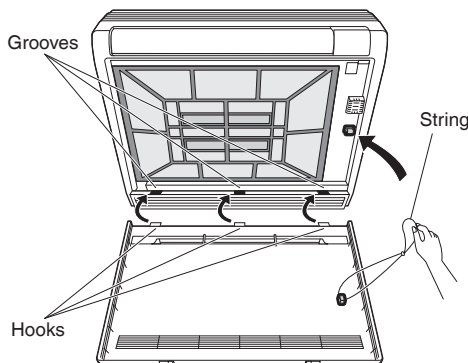

**5. Close the front panel slowly.**

- Slide the 2 stoppers on the left and right sides outward until they click.

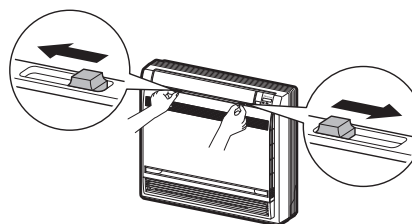

- Make sure that the front panel is securely fixed.

# Care and Cleaning

## ■ Air filter

**1. Open the front panel.** ▶Page 28

**2. Pull out the air filter.**

- Press the claws on the right and left of the air filter down slightly, then pull upward.

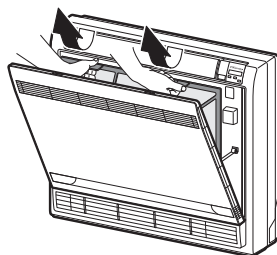

**3. Take off the titanium apatite deodorizing filters.**

- Hold the recessed parts of the frame and unhook the 4 claws.

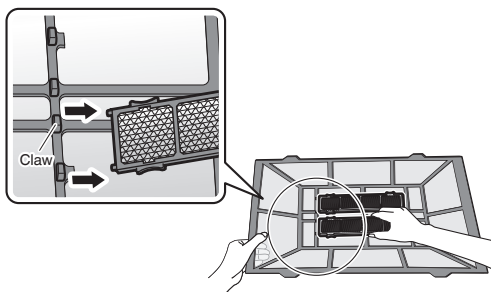

**4. Wash the air filter with water or clean it with a vacuum cleaner.**

- It is recommended to clean the air filter every 2 weeks.

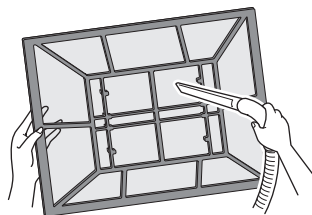

### If the dust does not come off easily

- Wash the air filter with neutral detergent thinned with lukewarm water, then let it dry in the shade.
- Be sure to remove the titanium apatite deodorizing filters. Refer to "Titanium apatite deodorizing filter" on the next page.

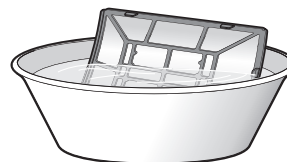

**5. Insert the titanium apatite deodorizing filters as they were.**

**6. Reattach the filters.**

**7. Close the front panel slowly.**

▶Page 28

■ Titanium apatite deodorizing filter

**1. Open the front panel and pull out the air filter.** ▶ Page 28,29

**2. Take off the titanium apatite deodorizing filters.**

- Hold the recessed parts of the frame and unhook the 4 claws.

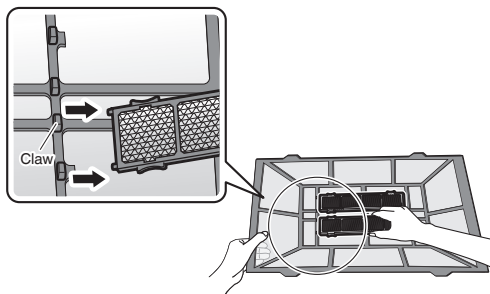

**3. Clean or replace the titanium apatite deodorizing filters.**

[Cleaning]

**3-1 Vacuum dust, and soak in lukewarm water or water for about 10 to 15 minutes if very dirty.**

- Do not remove the filter from the frame when washing with water.

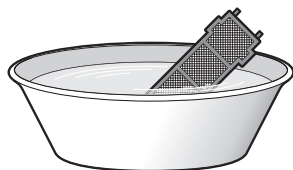

**3-2 After washing, shake off remaining water and let them dry in the shade.**

- Do not wring out the filter to remove water from it.

[Replacement]

**Remove the filter from the filter frame and prepare a new one.**

- Do not throw away the filter frame. Reuse the filter frames when replacing the titanium apatite deodorizing filters.

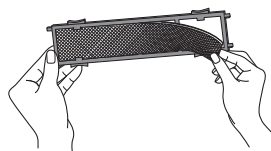

- Dispose of the old filter as non-flammable waste.

**4. Insert the titanium apatite deodorizing filters as they were.**

- When attaching the filter, check that the filter is properly set in the tabs.

**5. Reattach the filters.** ▶ Page 29

**6. Close the front panel slowly.**

▶ Page 28

**NOTE**

- Operation with dirty filters:
  - cannot deodorize the air,
  - cannot clean the air,
  - results in poor heating or cooling,
  - may cause odor.
- Dispose of old filters as non-flammable waste.
- To order a titanium apatite deodorizing filter, contact the dealer where you bought the air conditioner.



Item	Titanium apatite deodorizing filter (without frame) 1 set
Part No.	KAF968B42

## Care and Cleaning

---

### ■ Prior to a long period of non-use

#### **1. Operate the FAN mode for several hours to dry out the inside.**

- 1) Press  and select “”.
  - When a multi outdoor unit is connected, make sure the HEAT operation is not being used in other rooms before you use the FAN operation. [▶Page 25](#)
- 2) Press  and start the operation.

#### **2. After operation stops, turn off the circuit breaker for the room air conditioner.**

#### **3. Take out the batteries from the remote controller.**

### ■ We recommend periodical maintenance

- In certain operating conditions, the inside of the air conditioner may get foul after several seasons of use, resulting in poor performance. It is recommended to have periodical maintenance by a qualified contractor in addition to regular cleaning by the user.
- For qualified contractor maintenance, please contact the dealer where you bought the air conditioner.



# FAQ

## Indoor unit

### The flap does not start swinging immediately.

- The air conditioner is adjusting the position of the flap. The flap will start moving soon.

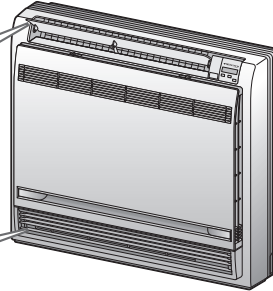

### Different sounds are heard.

- **A sound like flowing water**
  - This sound is generated because the refrigerant in the air conditioner is flowing.
  - This is a pumping sound of the water in the air conditioner and can be heard when the water is pumped out from the air conditioner during COOL or DRY operation.
  - The refrigerant flows in the air conditioner even if the air conditioner is not working when the indoor units in other rooms are in operation.
- **Blowing sound**
  - This sound is generated when the flow of the refrigerant in the air conditioner is switched over.
- **Ticking sound**
  - This sound is generated when the cabinet and frame of the air conditioner slightly expand or shrink as a result of temperature changes.
- **Whistling sound**
  - This sound is generated when refrigerant flows during defrosting operation.
- **Clicking sound during operation or idle time**
  - This sound is generated when the refrigerant control valves or the electrical parts operate.
- **Clopping sound**
  - This sound is heard from the inside of the air conditioner when the exhaust fan is activated while the room doors are closed. Open the window or turn off the exhaust fan.

### The air conditioner stops generating airflow during HEAT operation.

- Once the set temperature is reached, the airflow rate is reduced and operation stopped in order to avoid generating a cool airflow. Operation will resume automatically when the indoor temperature falls.

### HEAT operation stops suddenly and a flowing sound is heard.

- The outdoor unit is defrosting. HEAT operation starts after the frost on the outdoor unit has been removed. This can take about 4 to 12 minutes.

### Operation does not start soon.

- When  was pressed soon after operation was stopped.
- When the mode was reselected.
  - This is to protect the air conditioner. You should wait for about 3 minutes.

## Outdoor unit

### Operating sound is loud.

- When frost forms on the heat exchanger of the outdoor unit, the operating sound level increases slightly.

### The outdoor unit emits water or steam.

- **In HEAT operation**
  - The frost on the outdoor unit melts into water or steam when the air conditioner is in defrosting operation.
- **In COOL or DRY operation**
  - Moisture in the air condenses into water on the cool surface of the outdoor unit piping and drips.

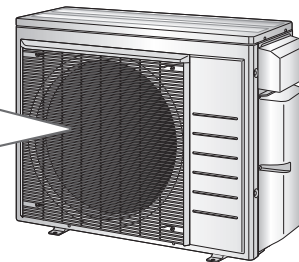

# Troubleshooting

Before making an inquiry or a request for repair, please check the following.  
If the problem persists, consult your dealer.



### Not a problem

This case is not a problem.



### Check

Please check again before requesting repairs.

## The air conditioner does not operate

Case	Description / what to check
OPERATION lamp is off.	<ul style="list-style-type: none"> <li>Has the circuit breaker been tripped or the fuse blown?</li> <li>Is there a power failure?</li> <li>Are batteries set in the remote controller?</li> </ul>
OPERATION lamp is blinking.	<ul style="list-style-type: none"> <li>Check the error code and consult your dealer. <a href="#">▶ Page 36</a></li> </ul>

## The air conditioner suddenly stops operating

Case	Description / what to check
OPERATION lamp is on.	<ul style="list-style-type: none"> <li>To protect the system, the air conditioner may stop operating after sudden large voltage fluctuations. It automatically resumes operation in about 3 minutes.</li> </ul>
OPERATION lamp is blinking.	<ul style="list-style-type: none"> <li>Is there anything blocking the air inlet or air outlet of the indoor unit or outdoor unit? Stop operation and after turning off the circuit breaker, remove the obstruction. Then restart operation with the remote controller. If the OPERATION lamp is still blinking, check the error code and consult your dealer. <a href="#">▶ Page 36</a></li> <li>Are operation modes all the same for indoor units connected to outdoor units in the multi system? If not, set all indoor units to the same operation mode and confirm that the lamps. Moreover, when the operation mode is in AUTO, set all indoor unit operation modes to COOL or HEAT for a moment and check again that the lamps are normal. If the lamps stop blinking after the above steps, there is no malfunction. <a href="#">▶ Page 25</a></li> </ul>

## The air conditioner does not stop operating

Case	Description / what to check
The air conditioner continues operating even after operation is stopped.	<ul style="list-style-type: none"> <li><b>Immediately after the air conditioner is stopped</b> <ul style="list-style-type: none"> <li>The outdoor unit fan continues rotating for about another 1 minute to protect the system.</li> </ul> </li> <li><b>While the air conditioner is not in operation</b> <ul style="list-style-type: none"> <li>When the outdoor temperature is high, the outdoor unit fan may start rotating to protect the system.</li> </ul> </li> </ul>

## The room does not cool down / warm up

Case	Description / what to check
Air does not come out.	<ul style="list-style-type: none"> <li><b>In HEAT operation</b> <ul style="list-style-type: none"> <li>The air conditioner is warming up. Wait for about 1 to 4 minutes.</li> <li>During defrosting operation, hot air does not flow out of the indoor unit.</li> </ul> </li> <li><b>When the air conditioner operates immediately after the circuit breaker is turned on</b> <ul style="list-style-type: none"> <li>The air conditioner is preparing to operate. Wait for about 3 to 20 minutes.</li> </ul> </li> </ul>
Air does not come out / Air comes out.	<ul style="list-style-type: none"> <li><b>Is the airflow rate setting appropriate?</b> <ul style="list-style-type: none"> <li>Is the airflow rate setting low, such as "Indoor unit quiet" or "Airflow rate 1"? Increase the airflow rate setting.</li> </ul> </li> <li><b>Is the set temperature appropriate?</b></li> <li><b>Is the adjustment of the airflow direction appropriate?</b></li> </ul>
Air comes out.	<ul style="list-style-type: none"> <li>Is there any furniture directly under or beside the indoor unit?</li> <li>Is the air conditioner in ECONO operation or QUIET OUTDOOR UNIT operation? <a href="#">▶ Page 15,16</a></li> <li>Is the air filter dirty?</li> <li>Is there anything blocking the air inlet or air outlet of the indoor unit or outdoor unit?</li> <li>Is a window or door open?</li> <li>Is an exhaust fan turning?</li> </ul>

**Mist comes out**

Case	Description / what to check
Mist comes out of the indoor unit.	<input checked="" type="checkbox"/> <ul style="list-style-type: none"> <li>This happens when the air in the room is cooled into mist by the cold airflow during COOL or other operation.</li> </ul>

**Remote controller**

Case	Description / what to check
The unit does not receive signals from the remote controller or has a limited operating range.	<input checked="" type="checkbox"/> <ul style="list-style-type: none"> <li>The batteries may be exhausted. Replace both batteries with new dry batteries AAA.LR03 (alkaline). For details, refer to "Preparation Before Operation". <b>▶ Page 9</b></li> <li>Signal communication may be disabled if an electronic-starter-type fluorescent lamp (such as inverter-type lamps) is in the room. Consult your dealer if that is the case.</li> <li>The remote controller may not function correctly if the transmitter is exposed to direct sunlight.</li> </ul>
LCD is faint, is not working, or the display is erratic.	<input checked="" type="checkbox"/> <ul style="list-style-type: none"> <li>The batteries may be exhausted. Replace both batteries with new dry batteries AAA.LR03 (alkaline). For details, refer to "Preparation Before Operation". <b>▶ Page 9</b></li> </ul>
Other electric devices start operating.	<input checked="" type="checkbox"/> <ul style="list-style-type: none"> <li>If the remote controller activates other electric devices, move them away or consult your dealer.</li> </ul>

**Air has an odor**

Case	Description / what to check
The air conditioner gives off an odor.	<input checked="" type="checkbox"/> <ul style="list-style-type: none"> <li>The room odor absorbed in the unit is discharged with the airflow. We recommend you to have the indoor unit cleaned. Please consult your dealer.</li> </ul>

**Others**

Case	Description / what to check
The air conditioner suddenly starts behaving strangely during operation.	<input type="checkbox"/> <ul style="list-style-type: none"> <li>The air conditioner may malfunction due to lightning or radio. If the air conditioner malfunctions, turn off the power with the circuit breaker and restart the operation with the remote controller.</li> </ul>
HEAT operation cannot be selected, even though the unit is heat pump model.	<input type="checkbox"/> <ul style="list-style-type: none"> <li>Check that the jumper (J8) has not been cut. If it has been cut, contact your dealer.</li> </ul> 
The ON/OFF TIMER does not operate according to the settings.	<input checked="" type="checkbox"/> <ul style="list-style-type: none"> <li>Check if the ON/OFF TIMER and the WEEKLY TIMER are set to the same time. Change or deactivate the settings in the WEEKLY TIMER. <b>▶ Page 19</b></li> </ul>

**Notes on the operating conditions**

- If operation continues under any conditions other than those listed in the table,
  - A safety device may activate to stop the operation. (With a multi connection in COOL operation, the safety device may work to stop the operation of the outdoor unit only.)
  - Dew may form on the indoor unit and drip from it when COOL or DRY operation is selected.
- \*1 Cutting the jumper on the outdoor unit PCB will extend the cooling operation range to 14°F (-10.0°C). Installing an air direction adjustment grille (sold separately) will further extend the operation range to -4°F (-20.0°C). Please consult your dealer.
- \*2 Installing a drain pan heater (sold separately) will further extend the heating operation range to -13°F (-25.0°C). Please consult your dealer.

Mode	Operating conditions
COOL / DRY	Outdoor temperature: [MXS, MXL, MXLH models]: 14 - 115°F (-10 - 46°C) [RXL models]: 50 <sup>1</sup> - 115°F (10 <sup>1</sup> - 46°C) *1 -4°F (-20°C) If an air direction adjustment grille (sold separately) is installed.
	Indoor temperature: 64 - 90°F (18 - 32°C)
	Indoor humidity: 80% max.
HEAT	Outdoor temperature: [MXS models]: 5 <sup>2</sup> - 75°F (-15 - 24°C) [MXL models]: 5 <sup>2</sup> - 75°F (-15 <sup>2</sup> - 24°C) [MXLH models]: -13 - 75°F (-25 - 24°C) [RXL models]: 5 <sup>2</sup> - 75°F (-15 <sup>2</sup> - 24°C) *2 -13°F (-25°C) If a drain pan heater (sold separately) is installed.
	Indoor temperature: 50 - 86°F (10 - 30°C)

# Troubleshooting

## The OPERATION lamp blinks

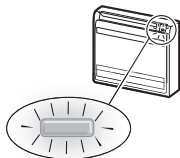

### ■ Check the interval time between blinks of the OPERATION lamp.

#### ■ If connecting to multiple indoor units

##### [Blink interval of about 2 to 3 seconds]

Check the operation mode of any indoor units connected in other rooms. Because this is a multi system air conditioner, it has one outdoor unit connected to multiple indoor units in different rooms.

If the operation mode is different from the operation mode of the indoor unit in another room, the OPERATION lamp may blink and operation may not be performed, or operation may stop while in progress.

COOL, DRY and HEAT operation may not be used at the same time.

##### [Blink interval of about 0.5 seconds]

This is a notification of an abnormality.

Check the error code following the procedure below, and respond according to the instructions in the table.



### ■ Fault diagnosis by remote controller



1. When  is held down for about 5 seconds, “00” blinks in the temperature display section.

2. While pointing the remote controller at the indoor unit, press  repeatedly.

A beep indicates a non-corresponding error code  
A long beep indicates a corresponding error code

3. When a long beep is produced, check the error code and respond according to the instructions in the table.

- To cancel the code display, hold down  for about 5 seconds (the code display also clears if no button is pressed for a while).

CODE	Cause	Description / what to check
E7	The fan of the outdoor unit is stopped. • Is there any foreign matter inside the outdoor unit?	After turning off the circuit breaker, remove the foreign matter, then turn the power on again and operate.
L3, L4, L5	The temperature inside the outdoor unit has become too high, so operation has stopped. • Is there anything blocking the air outlet of the outdoor unit?	After turning off the circuit breaker, remove the obstruction, then turn the power on again and operate.
Other error codes, or if the error code cannot be checked		An abnormality has occurred.

In the case of error code U0 or F3

	CODE	MEANING
SYSTEM	00	NORMAL
	UA	INDOOR-OUTDOOR UNIT COMBINATION FAULT
	U0	REFRIGERANT SHORTAGE
	U2	DROP VOLTAGE OR MAIN CIRCUIT OVERVOLTAGE
	U4	FAILURE OF TRANSMISSION (BETWEEN INDOOR UNIT AND OUTDOOR UNIT)
INDOOR UNIT	A1	INDOOR PCB DEFECTIVENESS
	A5	HIGH PRESSURE CONTROL OR FREEZE-UP PROTECTOR
	A6	FAN MOTOR FAULT
	C4	FAULTY HEAT EXCHANGER TEMPERATURE SENSOR
	C9	FAULTY SUCTION AIR TEMPERATURE SENSOR
OUTDOOR UNIT	EA	COOLING-HEATING SWITCHING ERROR
	E1	CIRCUIT BOARD FAULT
	E3*	HIGH PRESSURE SWITCH (HPS) ACTIVATED
	E5	OL (COMPRESSOR OVERLOAD) STARTED / HIGH PRESSURE SWITCH (HPS) ACTIVATED*
	E6	FAULTY COMPRESSOR START UP
	E7	DC FAN MOTOR FAULT
	F3	HIGH TEMPERATURE DISCHARGE PIPE CONTROL
	F6	HIGH PRESSURE CONTROL (IN COOLING)
	H0	SENSOR FAULT
	H6	OPERATION HALT DUE TO FAULTY POSITION DETECTION SENSOR
	H8	DC CURRENT SENSOR FAULT
	H9	FAULTY SUCTION AIR TEMPERATURE SENSOR
	J3	FAULTY DISCHARGE PIPE TEMPERATURE SENSOR
	J6	FAULTY HEAT EXCHANGER TEMPERATURE SENSOR
	L3	ELECTRICAL PARTS HEAT FAULT
L4	HIGH TEMPERATURE AT INVERTER CIRCUIT HEATSINK	
L5	OUTPUT OVERCURRENT	
P4	FAULTY INVERTER CIRCUIT HEATSINK TEMPERATURE SENSOR	

\*The contents of the error differ depending on the connected outdoor unit.

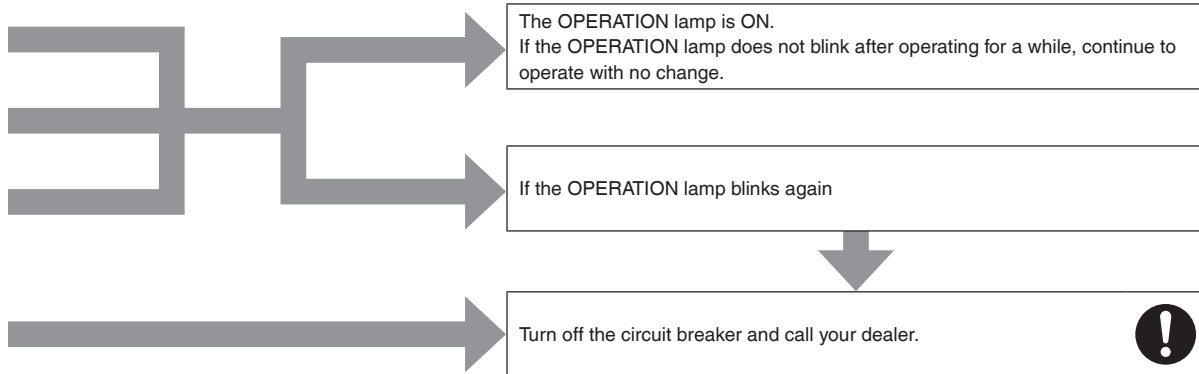

# Troubleshooting

## ■ Call your dealer immediately

### WARNING

**When an abnormality (such as a burning smell) occurs, stop operation and turn off the circuit breaker.**

- Continued operation in an abnormal condition may result in problems, electric shock or fire.
- Consult the dealer where you bought the air conditioner.

**Do not attempt to repair or modify the air conditioner by yourself.**

- Incorrect work may result in electric shock or fire.
- Consult the dealer where you bought the air conditioner.

**If one of the following symptoms takes place, call your dealer immediately.**

- The power cord is abnormally hot or damaged.
- An abnormal sound is heard during operation.
- The circuit breaker, a fuse, or the ground fault circuit interrupter cuts off the operation frequently.
- A switch or a button often fails to work properly.
- There is a burning smell.
- Water leaks from the indoor unit.

Turn off the circuit breaker and call your dealer. 

**■ After a power failure**

- The air conditioner automatically resumes operation in about 3 minutes. You should just wait for a while.

**■ Lightning**

- If there is a risk lightning could strike in the neighborhood, stop operation and turn off the circuit breaker to protect the system.

## ■ Disposal requirements

- Dismantling of the unit, handling of the refrigerant, oil and other parts, should be done in accordance with the relevant local and national regulations.

# Quick Reference

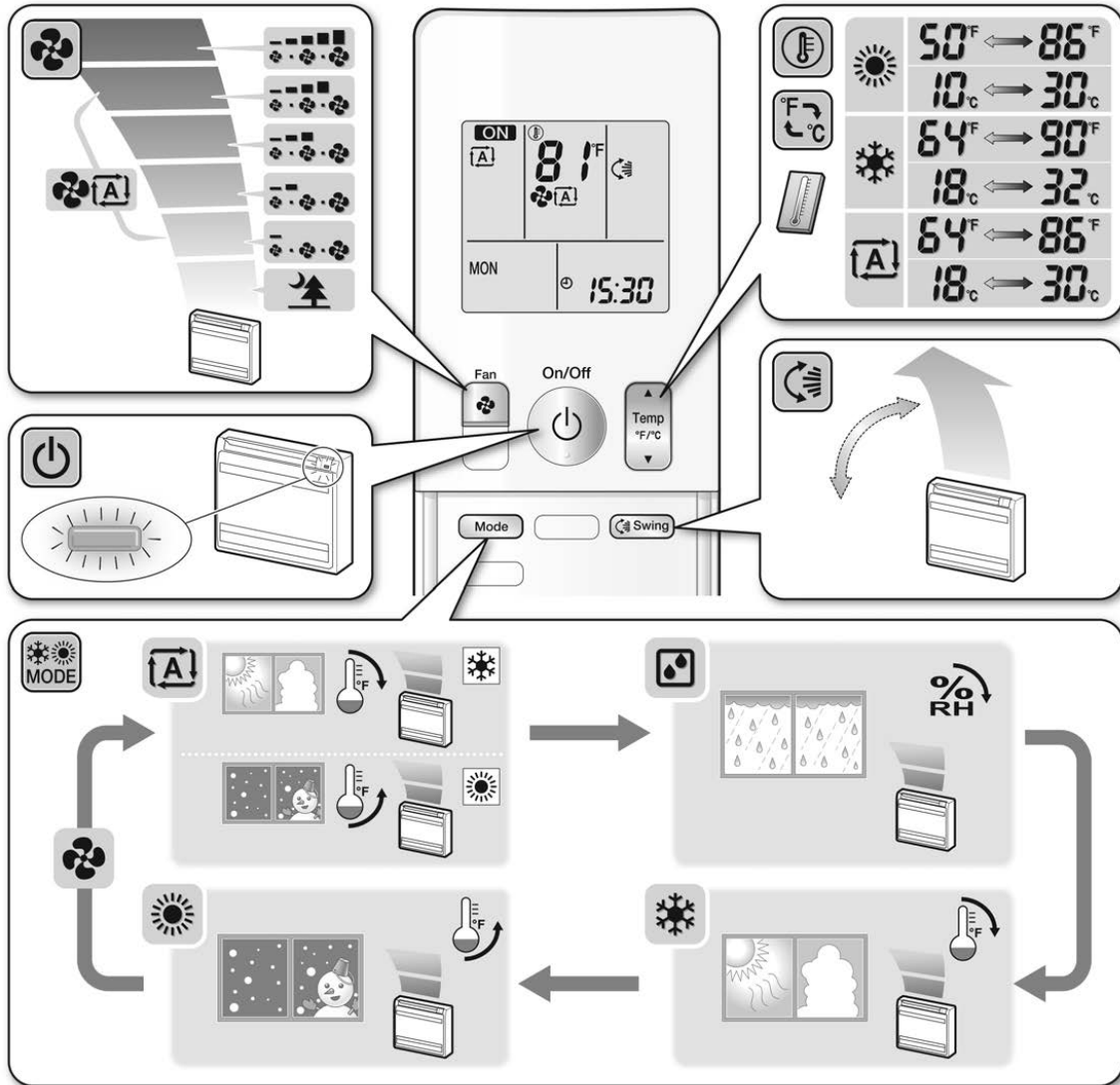

## 13.4 FDMQ

# Contents

### ■ Read Before Operation

Safety Considerations..... 1  
 Names of Parts ..... 4

### ■ Multi Connection

Note for Multi System ..... 5

### ■ Care

Care and Cleaning ..... 7

### ■ When the Need Arises

Troubleshooting ..... 9

The pictures in this document are for illustrative purposes only.

# Safety Considerations

Refer also to the General Safety Considerations in the separate booklet.



**Read the precautions in this manual carefully before operating the unit.**

Read these **Safety Considerations for Operations** carefully before operating an air conditioner or heat pump.

Make sure that the unit operates properly during the startup operation. Instruct the user on how to operate and maintain the unit. Inform users that they should store this operation manual with the installation manual for future reference.

Meanings of **DANGER**, **WARNING**, **CAUTION**, and **NOTE** Symbols:

**⚠ DANGER** ..... Indicates an imminently hazardous situation which, if not avoided, will result in death or serious injury.

**⚠ WARNING** ..... Indicates a potentially hazardous situation which, if not avoided, could result in death or serious injury.

**⚠ CAUTION** ..... Indicates a potentially hazardous situation which, if not avoided, may result in minor or moderate injury. It may also be used to alert against unsafe practices.

**⚠ NOTE** ..... Indicates situations that may result in equipment or property damage accidents only.

### — ⚠ DANGER —

- Do not install the unit in an area where flammable materials are present due to risk of explosion resulting in serious injury or death.
- Any abnormalities in the operation of the air conditioner or heat pump, such as smoke or fire, could result in severe injury or death. Turn off the power and contact your dealer immediately.
- Refrigerant gas may produce toxic gas if it comes into contact with fire, such as from a fan heater, stove, or cooking device. Exposure to this gas could cause severe injury or death.
- For refrigerant leakage, consult your dealer. Refrigerant gas is heavier than air and replaces oxygen. A massive leak could lead to oxygen depletion, especially in basements, and an asphyxiation hazard could occur leading to serious injury or death.
- If equipment utilizing a burner is used in the same room as the air conditioner or heat pump, there is the danger of oxygen deficiency which could lead to an asphyxiation hazard resulting in serious injury or death. Be sure to ventilate the room sufficiently to avoid this hazard.
- Safely dispose of the packing materials. Packing materials, such as nails and other metal or wooden parts, may cause stabs or other injuries.
- Tear apart and throw away plastic packaging bags so that children will not play with them. Children playing with plastic bags face the danger of death by suffocation.



### ⚠ WARNING

- Contact your dealer for repair and maintenance. Improper repair and maintenance may result in water leakage, electric shock, and fire. Only use accessories made by Daikin that are specifically designed for use with the equipment and have them installed by a professional.
- Contact your dealer to move and reinstall the air conditioner or heat pump. Incomplete installation may result in water leakage, electric shock, and fire.
- Never let the indoor unit or the remote controller get wet. Water can cause an electric shock or a fire.
- Never use flammable spray such as hair spray, lacquer, or paint near the unit. Flammable spray may cause a fire.
- When a fuse blows out, never replace it with one of incorrect ampere ratings or different wires. Always replace any blown fuse with a fuse of the same specification.
- Never remove the fan guard of the unit. A fan rotating at high speed without the fan guard is very dangerous.
- Never inspect or service the unit by yourself. Contact a qualified service person to perform this work.
- Turn off all electrical power before doing any maintenance to avoid the risk of serious electric shock; never sprinkle or spill water or liquids on the unit.
- Do not touch the switch with wet fingers. Touching a switch with wet fingers can cause electric shock.
- Do not allow children to play on or around the unit to prevent injury.
- The heat exchanger fins are sharp enough to cut. To avoid injury wear gloves or cover the fins while working around them.
- Do not put a finger or other objects into the air inlet or air outlet. The fan is rotating at high speed and will cause injury.
- Check the unit foundation for damage on a continuous basis, especially if it has been in use for a long time. If left in a damaged condition the unit may fall and cause injury.
- Do not touch the air outlet or horizontal blades while the swing flap is in operation because fingers could get caught and injured.
- Never touch the internal parts of the controller. Do not remove the front panel because some parts inside are dangerous to touch. To check and adjust internal parts, contact your dealer.
- Do not use means to accelerate the defrosting process or to clean, other than those recommended by the manufacturer.
- The appliance must be stored in a room without continuously operating ignition sources (for example: open flames, an operating gas appliance or an operating electric heater).
- Do not pierce or burn.
- Be aware that refrigerants may not contain an odor.

### ⚠ CAUTION

- Do not use the air conditioner or heat pump for any other purposes other than comfort cooling or heating. Do not use the unit for cooling precision instruments, food, plants, animals or works of art.
- Do not place items under the indoor unit as they may be damaged by condensates that may form if the humidity is above 80% or if the drain outlet gets blocked.
- Before cleaning, stop the operation of the unit by turning the power off or by pulling the supply cord out from its receptacle. Otherwise, an electric shock and injury may result.
- Do not wash the air conditioner or heat pump with excessive water. An electric shock or fire may result.
- Avoid placing the controller in a spot which may be splashed with water. Water entering the controller may cause an electric shock or damage the internal electronic parts.
- Do not operate the air conditioner or heat pump when using a room-fumigation type of insecticide. Failure to observe this could cause the chemicals to be deposited in the unit and can endanger the health of those who are hypersensitive to chemicals.
- Do not turn off the power immediately after stopping operation. Always wait for at least 5 minutes before turning off the power. Otherwise, water leakage may occur.
- The appliance is not intended for use by young children or infirm persons without supervision.
- The remote controller should be kept away from children so they cannot play with it.
- Consult with the installation contractor for cleaning.
- Incorrect cleaning of the inside of the air conditioner or heat pump could make the plastics parts break and cause water leakage or electric shock.
- Do not touch the air inlet or aluminum fin of the air conditioner or heat pump as they can cut and cause injury.
- Do not place objects in direct proximity of the outdoor unit. Do not let leaves and other debris accumulate around the unit. Leaves are a hotbed for small animals which can enter the unit. Once inside the unit, animals can cause the unit to malfunction, and cause smoke or fire when they make contact with electrical parts.

# Safety Considerations

— **⚠ NOTE** —

- Never press the button of the remote controller with a hard, pointed object. The remote controller may be damaged.
- Never pull or twist the electric wire of the remote controller. It may cause the unit to malfunction.
- Do not place appliances that produce open flames in places that are exposed to the airflow of the unit or under the indoor unit. It may cause incomplete combustion or deformation of the unit due to the heat.
- Do not expose the controller to direct sunlight. The LCD display can become discolored and may fail to display the data.
- Do not wipe the controller operation panel with benzine, thinner, chemical dust cloth, etc. The panel may get discolored or the coating can peel off. If it is heavily dirty, soak a cloth in water-diluted neutral detergent, squeeze it well and wipe the panel clean. Then wipe it with another dry cloth.
- Dismantling of the unit, disposal of the refrigerant, oil, and additional parts, should be done in accordance with the relevant local, state, and national regulations.
- Operate the air conditioner or heat pump in a sufficiently ventilated area and not surrounded by obstacles. Do not use the air conditioner or heat pump in the following places.
  - a. Places with a mist of mineral oil, such as cutting oil.
  - b. Locations such as coastal areas where there is a lot of salt in the air.
  - c. Locations such as hot springs where there is a lot of sulfur in the air.
  - d. Locations such as factories where the power voltage varies a lot.
  - e. In cars, boats, and other vehicles.
  - f. Locations such as kitchens where oil may splatter or where there is steam in the air.
  - g. Locations where equipment produces electromagnetic waves.
  - h. Places with an acid or alkaline mist.
  - i. Places where fallen leaves can accumulate or where weeds can grow.
- Take snow protection measures. Contact your dealer for the details of snow protection measures, such as the use of a snow protection hood.
- Do not attempt to do electrical work or grounding work unless you are licensed to do so. Consult with your dealer for electrical work and grounding work.
- Pay attention to operating sound. Be sure to use the following places:
  - a. Places that can sufficiently withstand the weight of the air conditioner or heat pump yet can suppress the operating sound and vibration.
  - b. Places where warm air from the air outlet of the outdoor unit or the operating sound of the outdoor unit does not annoy neighbors.

- Make sure that there are no obstacles close to the outdoor unit. Obstacles close to the outdoor unit may drop the performance of the outdoor unit or increase the operating sound of the outdoor unit.
- Consult your dealer if the air conditioner or heat pump in operation generates unusual noise.
- Make sure that the drainpipe is installed properly to drain water. If no water is discharged from the drainpipe while the air conditioner or heat pump is in the cooling mode, the drainpipe may be clogged with dust or dirt and water leakage from the indoor unit may occur. Stop operating the air conditioner or heat pump and contact your dealer.
- Do not spray the air conditioner unit with any deodorizers, etc. It may cause the unit to malfunction.

FFP002M-U

This is an appliance that is not accessible to the general public.

# Names of Parts

## Indoor Unit

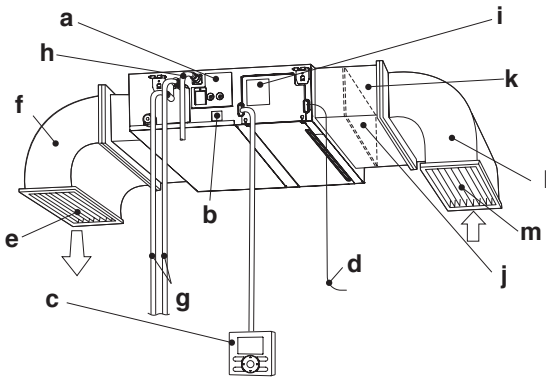

a	Drain discharge device (built-in)	g	Refrigerant piping
b	Drain pan inspection window	h	Drain piping
c	Remote controller (Wired type) The appearance of the remote controller may differ between different models.	i	Model name (Model name plate)
d	Wiring between the indoor and outdoor units	j	Air filter (Sold separately)
e	Air outlet grille (Field supply)	k	Suction filter chamber (Sold separately)
f	Exhaust duct (Field supply)	l	Suction duct (Field supply)
		m	Suction grille (Field supply)

## Remote controller

Wired type

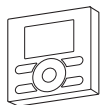

Wireless type

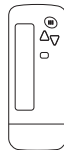

• For details on remote controller operation, refer to the operation manual included with the remote controller.

## Outdoor Unit

• The appearance of the outdoor unit may differ between different models.

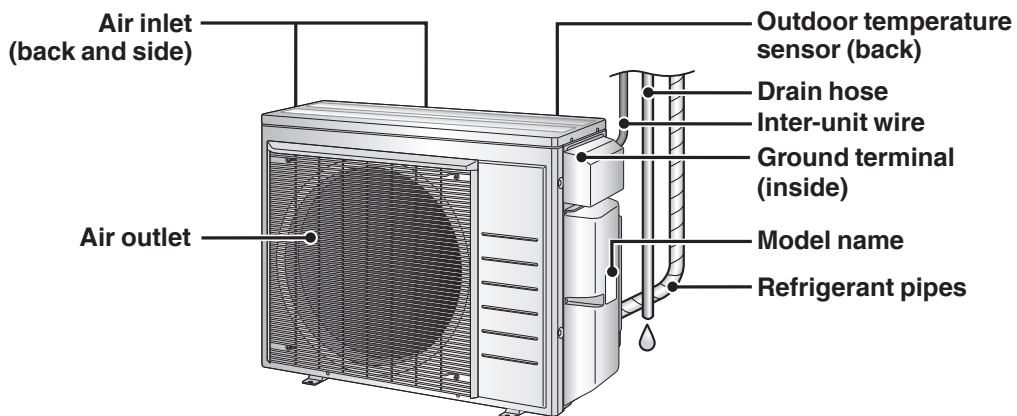

## Note for Multi System

A multi system has one outdoor unit connected to multiple indoor units.

### Selecting the operation mode

**When the priority room setting is active but the set unit is not operating or when the priority room setting is inactive**

When more than one indoor unit is operating, priority is given to the first unit that was turned on.

In this case, set the units that are turned on later to the same operation mode as the first unit.

Otherwise, they will enter the standby state, and when using the wired remote controller the centralized control icon "CENTRAL CONTROL" will light up; this does not indicate malfunction.

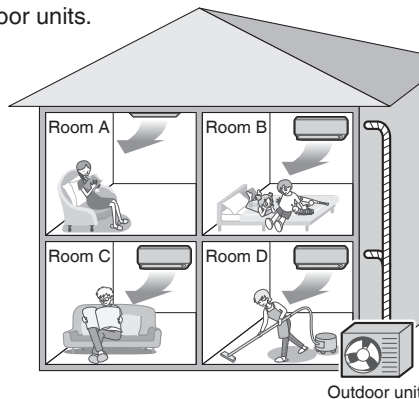

### NOTE

#### Notes on operation mode for a multi system

- COOL, DRY and FAN operation may be used at the same time.
- AUTO operation automatically selects COOL operation or HEAT operation based on the indoor temperature. Therefore, AUTO operation is available when selecting the same operation mode as that of the room with the first unit to be turned on.

### CAUTION

- Normally, the operation mode in the room where the unit is first started is given priority, but the following situations are exceptions to this rule. If the operation mode of the first room is FAN operation, then using HEAT operation in any room after this will give priority to HEAT operation. In this situation, the indoor unit operating in FAN mode will switch to standby, and when using the wired remote controller the centralized control icon "CENTRAL CONTROL" will light up.

### With the priority room setting active

Refer to "Priority room setting" on the next page.

### NIGHT QUIET mode (Available only for COOL operation)

NIGHT QUIET mode requires initial programming during installation. Please consult your retailer or dealer for assistance.

NIGHT QUIET mode reduces the operation noise of the outdoor unit during the night-time hours to prevent annoyance to neighbours.

- NIGHT QUIET mode is activated when the temperature drops 10.8°F (6°C) or more below the highest temperature recorded that day. When the temperature difference between the current outdoor temperature and the maximum outdoor temperature becomes less than 7.2°F (4°C), this function will be canceled.
- NIGHT QUIET mode slightly reduces the cooling efficiency of the unit.

### QUIET OUTDOOR UNIT operation (Function unavailable in the FDMQ series)

For details on QUIET OUTDOOR UNIT operation, refer to the operation manual included with the remote controller.

**When the priority room setting is active but the set unit is not operating or when the priority room setting is inactive**

When using the QUIET OUTDOOR UNIT operation feature with a multi system, set all indoor units to QUIET OUTDOOR UNIT operation using their remote controllers.

When canceling QUIET OUTDOOR UNIT operation, simply cancel the mode on one of the operating indoor units using their remote controller.

However QUIET OUTDOOR UNIT operation will remain displayed on the remote controllers for the other rooms.

We recommend you cancel operation in all rooms using their remote controllers.

### With the priority room setting active

Refer to "Priority room setting" on the next page.

### COOL/HEAT mode lock

The COOL/HEAT mode lock requires initial programming during installation. Please consult your authorized dealer for assistance. The COOL/HEAT mode lock sets the unit forcibly to either COOL or HEAT operation. This function is convenient when you wish to set all indoor units connected to the multi system to the same operation mode.

#### NOTE

- The COOL/HEAT mode lock cannot be activated together with the priority room setting.

### Priority room setting

The priority room setting requires initial programming during installation. Please consult your authorized dealer for assistance. The room designated as the priority room takes priority in the following situations.

#### Operation mode priority

- As the operation mode of the priority room takes precedence, you can select a different operation mode from other rooms.

#### [Example]

- Room A is the priority room in this example.  
When COOL operation is selected in room A while operating the following modes in room B, C and D:

Operation mode in room B, C and D	Status of room B, C and D when the unit in room A is in COOL operation
COOL or DRY or FAN	The current operation mode is maintained.
HEAT	The unit enters the standby mode. Operation resumes when the room A unit stops operating.
AUTO	If the unit is set to COOL operation, it continues. If the unit is set to HEAT operation, it enters the standby mode. Operation resumes when the room A unit stops operating.

#### Priority when QUIET OUTDOOR UNIT operation is used (Function unavailable in the FDMQ series)

#### [Example]

- Room A is the priority room in this example.  
Just by setting the unit in room A to QUIET operation, the air conditioner starts QUIET OUTDOOR UNIT operation. You do not have to set all the indoor units in operation to QUIET OUTDOOR UNIT operation.

#### Priority when POWERFUL operation is used (Function unavailable in the FDMQ series)

#### [Example]

- Room A is the priority room in this example.  
The indoor units in rooms A, B, C and D are all operating. If the unit in room A enters POWERFUL operation, operation capacity will be concentrated in room A. In such a case, the cooling (heating) efficiency of the units in room B, C and D may be slightly reduced.

# Care and Cleaning

## WARNING

- Only a qualified service person is allowed to perform maintenance.
- Before cleaning, be sure to stop unit operation and turn off the circuit breaker.  
Otherwise, an electric shock and injury may result.
- Contact a qualified person regarding the attachment of accessories and be sure to use only accessories specified by the manufacturer.  
If an accessory is attached incorrectly, water leakage, an electric shock, or fire may result.

## CAUTION

- When cleaning, use a sturdy and stable stand and watch your step.
- Do not touch the aluminium fins of the indoor unit. If you touch those parts, this may cause an injury.

### ■ How to clean the air filter

When the remote controller indicates "Time to clean filter", clean the air filter.

- It indicates after running for a certain time.

#### Notes on cleaning

For cleaning, do not use any of the following:

- Water hotter than 104°F (40°C)
- Volatile liquid such as benzene, gasoline and thinner
- Polishing compounds or liquid insecticide
- Rough materials such as a scrubbing brush
- Sprays such as deodorizers
- You may change the time of indication "Time to clean filter".



If the indoor unit is used in a space where the air is too contaminated, ask your local dealer for solution.

Contamination	Time until indication is displayed
Normal	2500 hours (equivalent to one year)
More contaminated	1250 hours (equivalent to a half year)

- If it becomes difficult to remove contamination from the air filter, replace the air filter.  
(Air filter for replacement is a separately sold accessory.)
- Do not remove the air filter except when cleaning. Unnecessary handling may damage the filter.  
(This product is not provided with an air filter as a standard accessory.)
- Do not attach objects other than the genuine air filter (e.g., kitchen paper) to the air inlet.  
Otherwise, the performance of the air conditioner will be degraded, and icing or water leakage may result.
- This product is a ceiling mounted duct type air conditioner.

#### Installing under roof

If the air filter (sold separately) is used, request a special contractor for the cleaning of the air filter.

#### Not installing under roof

Always use the long-life filter chamber (sold separately). Be sure to request your dealer for the installation of the long-life chamber. For the methods of mounting, dismantling, and cleaning the air filter, refer to the manual provided with the air filter.

- Be sure to use the separately sold filter chamber.  
Request your dealer for the installation of the filter chamber.
- Be sure to clean the air filter at the beginning of the cooling or heating season.  
(A decrease in the airflow volume of the air conditioner will result and the performance of the air conditioner will be degraded if the air filter is clogged with dust or dirt.)

Increase the frequency of cleaning if the unit is installed in a room where the air is extremely contaminated.

After completing cleaning and installing an air filter, turn off the indication of "Time to clean filter" on the remote controller.

- For details, refer to the operation manual attached to the remote controller.
- The indication can be turned off while the unit is either operating or stopped.

## ■ How to clean air outlet, outside panels and remote controller

- 1. Clean with soft cloth.**
- 2. When it is difficult to remove stains, use water or neutral detergent.**

### NOTE

- Do not wash the suction grille with water of 122°F (50°C) or higher. It may cause discoloration and deformation.
- When drying the suction grille, do not heat it with fire. It may cause burning.
- Do not use substances such as gasoline, benzene, thinner, polishing powder and liquid insecticide sold in the market. It may cause discoloration and deformation.

## ■ Prior to a long period of non-use

- 1. Operate the FAN mode for several hours on a fine day to dry out the inside.**

- 1) Press the "MODE" selector button and select "FAN" operation.
  - When a multi outdoor unit is connected, make sure the HEAT operation is not being used in other rooms before you use the FAN operation. ▶Page 5
- 2) Press the "ON/OFF" button and start operation.

- 2. After operation stops, turn off the circuit breaker for the room air conditioner.**

- 3. Clean the air filters and reattach them. ▶Page 7**

- 4. To prevent battery leakage, take out the batteries from the remote controller. (Only for the wireless remote controller)**

## ■ We recommend periodical maintenance

- In certain operating conditions, the inside of the air conditioner may get foul after several seasons of use, resulting in poor performance. It is recommended to have periodical maintenance by a specialist.
- For specialist maintenance, please contact the dealer where you bought the air conditioner.
- The maintenance cost must be borne by the user.

# Troubleshooting

Before making an inquiry or a request for repair, please check the following.  
If the problem persists, consult your dealer.



### Not a problem

This case is not a problem.



### Check

Please check again before requesting repairs.

Case	Description / what to check
<b>Operation does not start soon.</b> <ul style="list-style-type: none"> <li>When ON/OFF button was pressed soon after operation was stopped.</li> <li>When the mode was reselected.</li> </ul>	<input checked="" type="checkbox"/> <ul style="list-style-type: none"> <li>This is to protect the air conditioner. You should wait for about 3 minutes.</li> </ul>
<b>Air does not come out.</b>	<input checked="" type="checkbox"/> <ul style="list-style-type: none"> <li><b>In HEAT operation</b> <ul style="list-style-type: none"> <li>The air conditioner is warming up. Wait for about 1 to 4 minutes.</li> <li>During defrosting operation, hot air does not flow out of the indoor unit.</li> </ul> </li> <li><b>When the air conditioner operates immediately after the circuit breaker is turned on</b> <ul style="list-style-type: none"> <li>The air conditioner is preparing to operate. Wait for about 3 to 20 minutes.</li> </ul> </li> </ul>
<b>The HEAT operation stops suddenly and a flowing sound is heard.</b>	<input checked="" type="checkbox"/> <ul style="list-style-type: none"> <li>The system is taking away the frost on the outdoor unit. You should wait for about 4 to 12 minutes.</li> </ul>
<b>The outdoor unit emits water or steam.</b>	<input checked="" type="checkbox"/> <ul style="list-style-type: none"> <li><b>In HEAT mode</b> <ul style="list-style-type: none"> <li>The frost on the outdoor unit melts into water or steam when the air conditioner is in defrost operation.</li> </ul> </li> <li><b>In COOL or DRY mode</b> <ul style="list-style-type: none"> <li>Moisture in the air condenses into water on the cool surface of outdoor unit piping and drips.</li> </ul> </li> </ul>
<b>Mist comes out of the indoor unit.</b>	<input checked="" type="checkbox"/> <ul style="list-style-type: none"> <li>This happens when the air in the room is cooled into mist by the cold airflow during cooling operation.</li> </ul>
<b>The indoor unit gives out odor.</b>	<input checked="" type="checkbox"/> <ul style="list-style-type: none"> <li>This happens when smells of the room, furniture, or cigarettes are absorbed into the unit and discharged with the airflow. (If this happens, we recommend you to have the indoor unit washed by a technician. Consult your dealer where you bought the air conditioner.)</li> </ul>
<b>The outdoor fan rotates while the air conditioner is not in operation.</b>	<input checked="" type="checkbox"/> <ul style="list-style-type: none"> <li>After operation is stopped:                             <ul style="list-style-type: none"> <li>The outdoor fan continues rotating for another 1 minute for system protection.</li> </ul> </li> <li>While the air conditioner is not in operation:                             <ul style="list-style-type: none"> <li>When the outdoor temperature is very high, the outdoor fan starts rotating for system protection.</li> </ul> </li> </ul>
<b>The operation stopped suddenly. (OPERATION lamp* is on.)</b>	<input checked="" type="checkbox"/> <ul style="list-style-type: none"> <li>For system protection, the air conditioner may stop operating on a sudden large voltage fluctuation. It automatically resumes operation in about 3 minutes.</li> <li>Are operation modes all the same for indoor units connected to outdoor units in the <b>multi system</b>? If not, set all indoor units to the same operation mode.</li> </ul>
<b>The air conditioner does not operate. (OPERATION lamp* is off.)</b>	<input type="checkbox"/> <ul style="list-style-type: none"> <li>Hasn't the circuit breaker turned OFF or a fuse blown?</li> <li>Isn't it a power failure?</li> <li>Are batteries set in the remote controller?</li> <li>Is the timer setting correct?</li> </ul>
<b>Cooling (Heating) effect is poor.</b>	<input type="checkbox"/> <ul style="list-style-type: none"> <li>Are the air filters clean?</li> <li>Is there anything blocking the air inlet or the outlet of the indoor and the outdoor units?</li> <li>Is the temperature setting appropriate?</li> <li>Are the windows and doors closed?</li> <li>Are the airflow rate set appropriately?</li> </ul>
<b>Operation stops suddenly. (OPERATION lamp* is blinking.)</b>	<input type="checkbox"/> <ul style="list-style-type: none"> <li>Are the air filters clean?</li> <li>Is there anything blocking the air inlet or the outlet of the indoor and the outdoor units? Clean the air filters or take all obstacles away and turn the circuit breaker OFF. Then turn it ON again and try operating the air conditioner with the remote controller. If the lamp still blinks, call your dealer where you bought the air conditioner.</li> </ul>

\* The OPERATION lamp is on the receiver of the separately sold wireless remote controller or wired remote controller.



Case	Description / what to check
An abnormal functioning happens during operation.	 • The air conditioner may malfunction with lightning or radio waves. Turn the breaker OFF, turn it ON again and try operating the air conditioner with the remote controller.

**Notes on the operating conditions**

- If operation continues under any conditions other than those listed in the table,
  - A safety device may activate to stop the operation. (With a multi connection in COOL operation, the safety device may work to stop the operation of the outdoor unit only.)
  - Dew may form on the indoor unit and drip from it when COOL or DRY operation is selected.
- \*1 Cutting the jumper on the outdoor unit PCB will extend the cooling operation range to 14°F (-10.0°C). Installing an air direction adjustment grille (sold separately) will further extend the operation range to -4°F (-20.0°C). Please consult your dealer.
- \*2 Installing a drain pan heater (sold separately) will further extend the heating operation range to -13°F (-25.0°C). Please consult your dealer.

Mode	Operating conditions
COOL / DRY	Outdoor temperature: [MXS, MXL, MXLH models] : 14 - 115°F (-10 - 46°C) [RX, RXL models] : 50*1 - 115°F (10*1 - 46°C) *1 -4°F (-20°C) If an air direction adjustment grille (sold separately) is installed.
	Indoor temperature : 64 - 90°F (18 - 32°C) Indoor humidity : 80% max.
HEAT	Outdoor temperature: [MXS models] : 5 - 75°F (-15 - 24°C) [MXL models] : 5*2 - 75°F (-15*2 - 24°C) [MXLH models] : -13 - 75°F (-25 - 24°C) [RX models] : 5 - 75°F (-15 - 24°C) [RXL models] : 5*2 - 75°F (-15*2 - 24°C) *2 -13°F (-25°C) If a drain pan heater (sold separately) is installed.
	Indoor temperature : 50 - 86°F (10 - 30°C)

**■ Call your dealer immediately**

 **WARNING**

**When an abnormality (such as a burning smell) occurs, stop operation and turn off the circuit breaker.**

- Continued operation in an abnormal condition may result in problems, electric shock or fire.
- Consult the dealer where you bought the air conditioner.

**Do not attempt to repair or modify the air conditioner by yourself.**

- Incorrect work may result in electric shock or fire.
- Consult the dealer where you bought the air conditioner.

**If one of the following symptoms takes place, call your dealer immediately.**

- The power cord is abnormally hot or damaged.
- An abnormal sound is heard during operation.
- The circuit breaker cuts off the operation frequently.
- A switch or a button often fails to work properly.
- There is a burning smell.
- Water leaks from the indoor unit.

Turn off the circuit breaker and call your dealer.



**■ After a power failure**

- The air conditioner automatically resumes operation in about 3 minutes. You should just wait for a while.

**■ Lightning**

- If there is a risk lightning could strike in the neighborhood, stop operation and turn off the circuit breaker to protect the system.

**■ Disposal requirements**

- Dismantling of the unit, handling of the refrigerant, oil and other parts, should be done in accordance with the relevant local and national regulations.

## 13.5 General Safety Considerations (FTX, FDMQ, RXL)

### 1. General Safety Considerations

#### 1-1 About the documentation

- The original documentation is written in English. All other languages are translations.
- The precautions described in this document cover very important topics, follow them carefully.
- The installation of the system, and all activities described in the installation manual and in the installer references guide MUST be performed by an authorized installer.

#### 1-1-1 Meaning of warnings and symbols



**DANGER**

Indicates a situation that results in death or serious injury.



**DANGER: RISK OF ELECTROCUTION**

Indicates a situation that could result in electrocution.



**DANGER: RISK OF EXPLOSION**

Indicates a situation that could result in explosion.



**WARNING**

Indicates a situation that could result in death or serious injury.



**CAUTION**

Indicates a situation that could result in minor or moderate injury.



**NOTICE**

Indicates a situation that could result in equipment or property damage.



**INFORMATION**

Indicates useful tips or additional information.

Symbols used on the unit:

Symbol	Explanation
	Before installation, read the installation and operation manual, and the wiring instruction sheet.
	Before performing maintenance and service tasks, read the service manual.
	For more information, see the installer and user reference guide.
	The unit contains rotating parts. Be careful when servicing or inspecting the unit.

#### 1-2 For the user



**WARNING**

If you are NOT sure how to operate the unit, contact your installer.



**WARNING**

This appliance is not intended for use by persons, including children, with reduced physical, sensory or mental capabilities, or lack of experience and knowledge, unless they have been given supervision or instruction concerning use of the appliance by a person responsible for their safety.

Children should be supervised to ensure that they do not play with the appliance.

Cleaning and user maintenance must not be carried out by children without supervision.



**WARNING**

To prevent electrical shocks or fire:

- Do NOT rinse the unit.
- Do NOT operate the unit with wet hands.
- Do NOT place any objects containing water on the unit.



**CAUTION**

- Do NOT place any objects or equipment on top of the unit.
- Do NOT sit, climb or stand on the unit.

**1-3 For the installer**

**1-3-1 General**

If you are NOT sure how to install or operate the unit, contact your dealer.

The manual contains specific information about the required qualification of the working personnel for maintenance, service and repair operations.

Every working procedure that affects safety should only be carried out by competent persons.

 **DANGER**

- Do NOT touch the refrigerant piping, water piping or internal parts during and immediately after operation. It could be too hot or too cold. Give it time to return to normal temperature. If you must touch it, wear protective gloves.
- Do NOT touch any accidental leaking refrigerant.

 **WARNING**

Improper installation or attachment of equipment or accessories could result in electrical shock, short-circuit, leaks, fire or other damage to the equipment. Only use accessories, optional equipment and spare parts made or approved by Daikin.

 **WARNING**

Make sure installation, testing and applied materials comply with applicable legislation (on top of the instructions described in the Daikin documentation).

 **CAUTION**

Wear adequate personal protective equipment (protective gloves, safety glasses,...) when installing, maintaining or servicing the system.

 **WARNING**

Tear apart and throw away plastic packaging bags so that nobody, especially children, can play with them. Possible risk: suffocation.

 **WARNING**

Provide adequate measures to prevent that the unit can be used as a shelter by small animals. Small animals that make contact with electrical parts can cause malfunctions, smoke or fire.

 **CAUTION**

Do NOT touch the air inlet or aluminum fins of the unit.

 **CAUTION**

- Do NOT place any objects or equipment on top of the unit.
- Do NOT sit, climb or stand on the unit.

 **NOTICE**

Works executed on the outdoor unit are best done under dry weather conditions to avoid water ingress.

In accordance with the applicable legislation, it might be necessary to provide a logbook with the product containing at least: information on maintenance, repair work, results of tests, stand-by periods,...

Also, at least, following information MUST be provided at an accessible place at the product:

- Instructions for shutting down the system in case of an emergency
- Name and address of fire department, police and hospital
- Name, address and day and night telephone numbers for obtaining service
- ISO 5149 provides the necessary guidance for this logbook.

**1-3-2 Installation site**

- Provide sufficient space around the unit for servicing and air circulation as outlined in the unit installation manual.
- Make sure the installation site withstands the weight and vibration of the unit.
- Make sure the unit is level.

Do NOT install the unit in the following places:

- In potentially explosive atmospheres.
- In places where there is machinery that emits electromagnetic waves. Electromagnetic waves may disturb the control system, and cause malfunction of the equipment.
- In places where there is a risk of fire due to the leakage of flammable gases (example: thinner or gasoline), carbon fiber, or ignitable dust.
- In places where corrosive gas (example: sulfurous acid gas) is produced. Corrosion of copper pipes or soldered parts may cause the refrigerant to leak.

**1-3-3 Refrigerant**

If applicable. See the installation manual or installer reference guide of your application for more information.



**NOTICE**

Make sure refrigerant piping installation complies with applicable legislation. ISO 5149 is the applicable standard.



**NOTICE**

Make sure the field piping and connections are NOT subjected to stress.



**WARNING**

During tests, NEVER pressurize the product with a pressure higher than the maximum allowable pressure (as indicated on the nameplate of the unit).



**WARNING**

Take sufficient precautions in case of refrigerant leakage. If refrigerant gas leaks, ventilate the area immediately.

Possible risks:

- Excessive refrigerant concentrations in a closed room can lead to oxygen deficiency.
- In case of R410A or R32 refrigerant: Toxic gas might be produced if refrigerant gas comes into contact with fire.
- In case of CO<sub>2</sub> refrigerant: Refrigerant gas is toxic in high concentrations.



**DANGER: RISK OF EXPLOSION**

**Pump down – Refrigerant leakage.** If you want to pump down the system, and there is a leak in the refrigerant circuit:

- Do NOT use the unit's automatic pump down function, with which you can collect all refrigerant from the system into the outdoor unit. **Possible consequence:** Explosion of the compressor because of air going into the operating compressor.
- Use a separate recovery system so that the unit's compressor does NOT have to operate.



**WARNING**

ALWAYS recover the refrigerant. Do NOT release them directly into the environment. Use a vacuum pump to evacuate the installation.



**NOTICE**

- After all the piping has been connected, make sure there are no gas leaks.



**NOTICE**

- To avoid compressor breakdown, do NOT charge more than the specified amount of refrigerant.





**DANGER: RISK OF EXPLOSION**

Make sure there is no oxygen in the system. Refrigerant may only be charged after performing a leak test and vacuum drying.

**Possible consequence:** Explosion of the compressor because of oxygen going into the operating compressor.

- In case recharge is required, see the nameplate of the unit. It states the type of refrigerant and necessary amount.
- The unit is factory charged with refrigerant, but depending on pipe sizes and pipe lengths some systems require additional charging of refrigerant.
- Only use tools exclusively for the refrigerant type used in the system. This to ensure pressure resistance and prevent foreign materials from entering into the system.
- Charge the liquid refrigerant as follows:

If	Then
A siphon tube is present (i.e., the cylinder is marked with "Liquid filling siphon attached")	Charge with the cylinder upright. 
A siphon tube is NOT present	Charge with the cylinder upside down. 

- Open refrigerant cylinders slowly.
- Charge the refrigerant in liquid form. Adding it in gas form may prevent normal operation.



**CAUTION**

When the refrigerant charging procedure is done or when pausing, close the valve of the refrigerant tank immediately. If the valve is NOT closed immediately, remaining pressure might charge additional refrigerant. **Possible consequence:** Incorrect refrigerant amount.

1-3-4 Electrical

 **DANGER: RISK OF ELECTROCUTION**

- Turn OFF all power supplies before removing the switch box cover, connecting electrical wiring, or touching electrical parts.
- Disconnect the power supply for more than 1 minute, and measure the voltage at the terminals of main circuit capacitors or electrical components before servicing. The voltage MUST be less than 50V DC before you can touch electrical components. For the location of the terminals, see the wiring diagram.
- Do NOT touch electrical components with wet hands.
- Do NOT leave the unit unattended when the service cover is removed.

 **WARNING**

If NOT factory installed, a main switch or other means for disconnection, having a contact separation in all poles providing full disconnection under overvoltage category III conditions, MUST be installed in the fixed wiring.

 **WARNING**



- ONLY use copper wires.
- Make sure the field wiring complies with the applicable legislation.
- All field wiring MUST be performed in accordance with the wiring diagram supplied with the product.
- NEVER squeeze bundled cables and make sure they do NOT come in contact with the piping and sharp edges. Make sure no external pressure is applied to the terminal connections.
- Make sure to install ground wiring. Do NOT ground the unit to a utility pipe, surge absorber, or telephone ground. Incomplete grounding may cause electrical shock.
- Ensure that the REFRIGERATING SYSTEM is grounded prior to charging the system with refrigerant.
- Make sure to use a dedicated power circuit. NEVER use a power supply shared by another appliance.
- Make sure to install the required fuses or circuit breakers.
- Make sure to install a ground leakage protector where required by local codes. Failure to do so may cause electrical shock or fire.
- When installing the ground leakage protector, make sure it is compatible with the inverter (resistant to high frequency electric noise) to avoid unnecessary opening of the ground leakage protector.

 **CAUTION**

- When connecting the power supply: connect the ground cable first, before making the current-carrying connections.
- When disconnecting the power supply: disconnect the current-carrying cables first, before separating the ground connection.
- The length of the conductors between the power supply stress relief and the terminal block itself must be such that, in case the power supply is pulled loose from the stress relief, the current-carrying wires become taut before the ground wire becomes taut.

 **NOTICE**

Precautions when laying power wiring:

- Do NOT connect wiring of different thicknesses to the power terminal block (slack in the power wiring may cause abnormal heat).
- When connecting wiring which is the same thickness, do as shown in the figure above.
- For wiring, use the designated power wire and connect firmly, then secure to prevent outside pressure being exerted on the terminal board.
- Use an appropriate screwdriver for tightening the terminal screws. A screwdriver with a small head will damage the screw heads and make proper tightening impossible.
- Over-tightening the terminal screws may break them.

Install power cables at least 3.3ft away from televisions or radios to prevent interference. Depending on the radio waves, a distance of 3.3ft may not be sufficient.

 **WARNING**

- After finishing the electrical work, confirm that each electrical component and terminal inside the electrical components box is connected securely.
- Make sure all covers are closed before starting up the unit.

### 1-3-5 Disposal

When removing refrigerant from a system, either for servicing or decommissioning, it is recommended good practice that all refrigerant is removed safely.

- When transferring refrigerant into cylinders, ensure that only appropriate refrigerant recovery cylinders are employed.
- Ensure that the correct number of cylinders for holding the total system charge is available.
- Ensure that all cylinders to be used are designated for the recovered refrigerant and labelled for that refrigerant (i. e. special cylinders for the recovery of refrigerant).
- Cylinders should be complete with pressure-relief valve and associated shut-off valves in good working order.
- Empty recovery cylinders should be evacuated and, if possible, cooled before recovery occurs.
- The recovery equipment should be in good working order with a set of instructions concerning the equipment that is at hand and should be suitable for the recovery of all appropriate refrigerants including, when applicable, FLAMMABLE REFRIGERANT.
- In addition, a set of calibrated weighing scales should be available and in good working order.
- Hoses should be complete with leak-free disconnect couplings and in good condition.
- Consult the manufacturer if in doubt.
- The recovered refrigerant should be returned to the refrigerant supplier in the correct recovery cylinder, and the relevant waste transfer note should be arranged.
- Do not mix refrigerants in recovery units and especially not in cylinders.
- The evacuation process should be carried out prior to returning the compressor to the suppliers.
- Only electric heating of the compressor body should be employed to accelerate this process.
- When oil is drained from a system, oil drainage should be carried out safely.

### 1-4 Glossary

#### Your dealer

Sales distributor for the product.

#### Authorized installer

Technically skilled person who is qualified to install the product.

#### User

Person who is owner of the product and/or operates the product.

#### Applicable legislation

All international, national and local directives, laws, regulations and/or codes that are relevant and applicable for a certain product or domain.

#### Service company

Qualified company which can perform or coordinate the required service on the product.

#### Installation manual

Instruction manual specified for a certain product or application, explaining how to install, configure and maintain it.

#### Operation manual

Instruction manual specified for a certain product or application, explaining how to operate it.

#### Maintenance instructions

Instruction manual specified for a certain product or application, which explains (if relevant) how to install, configure, operate and/or maintain the product or application.

#### Accessories

Labels, manuals, information sheets and pieces of equipment that are delivered with the product and that need to be installed according to the instructions in the accompanying documentation.

#### Equipment sold separately

Equipment made or approved by Daikin that can be combined with the product according to the instructions in the accompanying documentation.

#### Field supply

Equipment NOT made by Daikin that can be combined with the product according to the instructions in the accompanying documentation.

## 13.6 General Safety Considerations (FVXS)

### 1. General Safety Considerations

#### 1-1 About the documentation

- The original documentation is written in English. All other languages are translations.
- The precautions described in this document cover very important topics, follow them carefully.
- The installation of the system, and all activities described in the installation manual and in the installer reference guide MUST be performed by an authorized installer.

#### 1-1-1 Meaning of warnings and symbols



**DANGER**

Indicates a situation that results in death or serious injury.



**DANGER: RISK OF ELECTROCUTION**

Indicates a situation that could result in electrocution.



**DANGER: RISK OF EXPLOSION**

Indicates a situation that could result in explosion.



**WARNING**

Indicates a situation that could result in death or serious injury.



**CAUTION**

Indicates a situation that could result in minor or moderate injury.



**NOTICE**

Indicates a situation that could result in equipment or property damage.



**INFORMATION**

Indicates useful tips or additional information.

Symbols used on the unit:

Symbol	Explanation
	Before installation, read the installation and operation manual, and the wiring instruction sheet.
	Before performing maintenance and service tasks, read the service manual.
	For more information, see the installer and user reference guide.
	The unit contains rotating parts. Be careful when servicing or inspecting the unit.

#### 1-2 For the user



**WARNING**

If you are NOT sure how to operate the unit, contact your installer.



**WARNING**

This appliance is not intended for use by persons, including children, with reduced physical, sensory or mental capabilities, or lack of experience and knowledge, unless they have been given supervision or instruction concerning use of the appliance by a person responsible for their safety.

Children should be supervised to ensure that they do not play with the appliance.

Cleaning and user maintenance must not be carried out by children without supervision.



**WARNING**

To prevent electrical shocks or fire:

- Do NOT rinse the unit.
- Do NOT operate the unit with wet hands.
- Do NOT place any objects containing water on the unit.



**CAUTION**

- Do NOT place any objects or equipment on top of the unit.
- Do NOT sit, climb or stand on the unit.

**1-3 For the installer**

**1-3-1 General**

If you are NOT sure how to install or operate the unit, contact your dealer.

The manual contains specific information about the required qualification of the working personnel for maintenance, service and repair operations.

Every working procedure that affects safety should only be carried out by competent persons.

 **DANGER**

- Do NOT touch the refrigerant piping, water piping or internal parts during and immediately after operation. It could be too hot or too cold. Give it time to return to normal temperature. If you must touch it, wear protective gloves.
- Do NOT touch any accidental leaking refrigerant.

 **WARNING**

Improper installation or attachment of equipment or accessories could result in electrical shock, short-circuit, leaks, fire or other damage to the equipment. Only use accessories, optional equipment and spare parts made or approved by Daikin.

 **WARNING**

Make sure installation, testing and applied materials comply with applicable legislation (on top of the instructions described in the Daikin documentation).

 **CAUTION**

Wear adequate personal protective equipment (protective gloves, safety glasses,...) when installing, maintaining or servicing the system.

 **WARNING**

Tear apart and throw away plastic packaging bags so that nobody, especially children, can play with them. Possible risk: suffocation.

 **WARNING**

Provide adequate measures to prevent that the unit can be used as a shelter by small animals. Small animals that make contact with electrical parts can cause malfunctions, smoke or fire.

 **CAUTION**

Do NOT touch the air inlet or aluminum fins of the unit.

 **CAUTION**

- Do NOT place any objects or equipment on top of the unit.
- Do NOT sit, climb or stand on the unit.

 **NOTICE**

Works executed on the outdoor unit are best done under dry weather conditions to avoid water ingress.

In accordance with the applicable legislation, it might be necessary to provide a logbook with the product containing at least: information on maintenance, repair work, results of tests, stand-by periods,...

Also, at least, following information MUST be provided at an accessible place at the product:

- Instructions for shutting down the system in case of an emergency
- Name and address of fire department, police and hospital
- Name, address and day and night telephone numbers for obtaining service
- ISO 5149 provides the necessary guidance for this logbook.

**1-3-2 Installation site**

- Provide sufficient space around the unit for servicing and air circulation as outlined in the unit installation manual.
- Make sure the installation site withstands the weight and vibration of the unit.
- Make sure the unit is level.

Do NOT install the unit in the following places:

- In potentially explosive atmospheres.
- In places where there is machinery that emits electromagnetic waves. Electromagnetic waves may disturb the control system, and cause malfunction of the equipment.
- In places where there is a risk of fire due to the leakage of flammable gases (example: thinner or gasoline), carbon fiber, or ignitable dust.
- In places where corrosive gas (example: sulfurous acid gas) is produced. Corrosion of copper pipes or soldered parts may cause the refrigerant to leak.



**1-3-3 Refrigerant**

If applicable. See the installation manual or installer reference guide of your application for more information.



**NOTICE**

Make sure refrigerant piping installation complies with applicable legislation. ISO 5149 is the applicable standard.



**NOTICE**

Make sure the field piping and connections are NOT subjected to stress.



**WARNING**

During tests, NEVER pressurize the product with a pressure higher than the maximum allowable pressure (as indicated on the nameplate of the unit).



**WARNING**

Take sufficient precautions in case of refrigerant leakage. If refrigerant gas leaks, ventilate the area immediately.

Possible risks:

- Excessive refrigerant concentrations in a closed room can lead to oxygen deficiency.
- In case of R410A or R32 refrigerant: Toxic gas might be produced if refrigerant gas comes into contact with fire.
- In case of CO<sub>2</sub> refrigerant: Refrigerant gas is toxic in high concentrations.



**DANGER: RISK OF EXPLOSION**

**Pump down – Refrigerant leakage.** If you want to pump down the system, and there is a leak in the refrigerant circuit:

- Do NOT use the unit's automatic pump down function, with which you can collect all refrigerant from the system into the outdoor unit. **Possible consequence:** Explosion of the compressor because of air going into the operating compressor.
- Use a separate recovery system so that the unit's compressor does NOT have to operate.



**WARNING**

ALWAYS recover the refrigerant. Do NOT release them directly into the environment. Use a vacuum pump to evacuate the installation.



**NOTICE**

- After all the piping has been connected, make sure there are no gas leaks.



**NOTICE**

- To avoid compressor breakdown, do NOT charge more than the specified amount of refrigerant.





**DANGER: RISK OF EXPLOSION**

Make sure there is no oxygen in the system. Refrigerant may only be charged after performing a leak test and vacuum drying.

**Possible consequence:** Explosion of the compressor because of oxygen going into the operating compressor.

- In case recharge is required, see the nameplate of the unit. It states the type of refrigerant and necessary amount.
- The unit is factory charged with refrigerant, but depending on pipe sizes and pipe lengths some systems require additional charging of refrigerant.
- Only use tools exclusively for the refrigerant type used in the system. This to ensure pressure resistance and prevent foreign materials from entering into the system.
- Charge the liquid refrigerant as follows:

If	Then
A siphon tube is present (i.e., the cylinder is marked with "Liquid filling siphon attached")	Charge with the cylinder upright. 
A siphon tube is NOT present	Charge with the cylinder upside down. 

- Open refrigerant cylinders slowly.
- Charge the refrigerant in liquid form. Adding it in gas form may prevent normal operation.



**CAUTION**

When the refrigerant charging procedure is done or when pausing, close the valve of the refrigerant tank immediately. If the valve is NOT closed immediately, remaining pressure might charge additional refrigerant. **Possible consequence:** Incorrect refrigerant amount.

1-3-4 Electrical



**DANGER: RISK OF ELECTROCUTION**

- Turn OFF all power supplies before removing the switch box cover, connecting electrical wiring, or touching electrical parts.
- Disconnect the power supply for more than 1 minute, and measure the voltage at the terminals of main circuit capacitors or electrical components before servicing. The voltage MUST be less than 50V DC before you can touch electrical components. For the location of the terminals, see the wiring diagram.
- Do NOT touch electrical components with wet hands.
- Do NOT leave the unit unattended when the service cover is removed.



**WARNING**

If NOT factory installed, a main switch or other means for disconnection, having a contact separation in all poles providing full disconnection under overvoltage category III conditions, MUST be installed in the fixed wiring.



**WARNING**

- ONLY use copper wires.
- Make sure the field wiring complies with the applicable legislation.
- All field wiring MUST be performed in accordance with the wiring diagram supplied with the product.
- NEVER squeeze bundled cables and make sure they do NOT come in contact with the piping and sharp edges. Make sure no external pressure is applied to the terminal connections.
- Make sure to install ground wiring. Do NOT ground the unit to a utility pipe, surge absorber, or telephone ground. Incomplete grounding may cause electrical shock.
- Ensure that the REFRIGERATING SYSTEM is grounded prior to charging the system with refrigerant.
- Make sure to use a dedicated power circuit. NEVER use a power supply shared by another appliance.
- Make sure to install the required fuses or circuit breakers.
- Make sure to install a ground leakage protector where required by local codes. Failure to do so may cause electrical shock or fire.
- When installing the ground leakage protector, make sure it is compatible with the inverter (resistant to high frequency electric noise) to avoid unnecessary opening of the ground leakage protector.



**CAUTION**

- When connecting the power supply: connect the ground cable first, before making the current-carrying connections.
- When disconnecting the power supply: disconnect the current-carrying cables first, before separating the ground connection.
- The length of the conductors between the power supply stress relief and the terminal block itself must be such that, in case the power supply is pulled loose from the stress relief, the current-carrying wires become taut before the ground wire becomes taut.



**NOTICE**

Precautions when laying power wiring:



- Do NOT connect wiring of different thicknesses to the power terminal block (slack in the power wiring may cause abnormal heat).
- When connecting wiring which is the same thickness, do as shown in the figure above.
- For wiring, use the designated power wire and connect firmly, then secure to prevent outside pressure being exerted on the terminal board.
- Use an appropriate screwdriver for tightening the terminal screws. A screwdriver with a small head will damage the screw heads and make proper tightening impossible.
- Over-tightening the terminal screws may break them.

Install power cables at least 3.3ft away from televisions or radios to prevent interference. Depending on the radio waves, a distance of 3.3ft may not be sufficient.



**WARNING**

- After finishing the electrical work, confirm that each electrical component and terminal inside the electrical components box is connected securely.
- Make sure all covers are closed before starting up the unit.

**1-3-5 Disposal**

When removing refrigerant from a system, either for servicing or decommissioning, it is recommended good practice that all refrigerant is removed safely.

- When transferring refrigerant into cylinders, ensure that only appropriate refrigerant recovery cylinders are employed.
- Ensure that the correct number of cylinders for holding the total system charge is available.
- Ensure that all cylinders to be used are designated for the recovered refrigerant and labelled for that refrigerant (i. e. special cylinders for the recovery of refrigerant).
- Cylinders should be complete with pressure-relief valve and associated shut-off valves in good working order.
- Empty recovery cylinders should be evacuated and, if possible, cooled before recovery occurs.
- The recovery equipment should be in good working order with a set of instructions concerning the equipment that is at hand and should be suitable for the recovery of all appropriate refrigerants including, when applicable, FLAMMABLE REFRIGERANT.
- In addition, a set of calibrated weighing scales should be available and in good working order.
- Hoses should be complete with leak-free disconnect couplings and in good condition.
- Consult the manufacturer if in doubt.
- The recovered refrigerant should be returned to the refrigerant supplier in the correct recovery cylinder, and the relevant waste transfer note should be arranged.
- Do not mix refrigerants in recovery units and especially not in cylinders.
- The evacuation process should be carried out prior to returning the compressor to the suppliers.
- Only electric heating of the compressor body should be employed to accelerate this process.
- When oil is drained from a system, oil drainage should be carried out safely.

**1-4 Glossary**

**Your dealer**

Sales distributor for the product.

**Authorized installer**

Technically skilled person who is qualified to install the product.

**User**

Person who is owner of the product and/or operates the product.

**Applicable legislation**

All international, national and local directives, laws, regulations and/or codes that are relevant and applicable for a certain product or domain.

**Service company**

Qualified company which can perform or coordinate the required service on the product.

**Installation manual**

Instruction manual specified for a certain product or application, explaining how to install, configure and maintain it.

**Operation manual**

Instruction manual specified for a certain product or application, explaining how to operate it.

**Maintenance instructions**

Instruction manual specified for a certain product or application, which explains (if relevant) how to install, configure, operate and/or maintain the product or application.

**Accessories**

Labels, manuals, information sheets and pieces of equipment that are delivered with the product and that need to be installed according to the instructions in the accompanying documentation.

**Equipment sold separately**

Equipment made or approved by Daikin that can be combined with the product according to the instructions in the accompanying documentation.

**Field supply**

Equipment NOT made by Daikin that can be combined with the product according to the instructions in the accompanying documentation.

### 13.7 <BRC1E73> Wired Remote Controller

# Safety Considerations



The original instructions are written in English. All other languages are translation of the original instructions.

Read these **SAFETY CONSIDERATIONS** carefully before operating the remote controller.





Train the customer to operate and maintain the remote controller.





Inform customers that they should store this Operations Manual with the Installation Manual for future reference.

Meanings of **WARNING** and **CAUTION** Symbols:







 <b>WARNING</b>	Indicates a potentially hazardous situation which, if not avoided, could result in death or serious injury.
 <b>CAUTION</b>	Indicates a potentially hazardous situation which, if not avoided, may result in minor or moderate injury. It may also be used to alert against unsafe practices.
 <b>NOTE</b>	Indicates situations that may result in equipment or property-damage accidents only.





- The following pictograms are used in this manual.

	Never do.		Always follow the instructions given.
	Keep water and moisture away.		Keep wet hands away.

 <b>WARNING</b>	
	<ul style="list-style-type: none"> <li>• <b>Do not modify or repair the remote controller.</b> Consult your Daikin dealer for any modification or for repairs.</li> </ul>
	<ul style="list-style-type: none"> <li>• <b>Do not relocate or reinstall the remote controller by yourself.</b> Improper installation may result in electric shocks or fire. Consult your Daikin dealer to relocate or for any reinstallation.</li> </ul>
	<ul style="list-style-type: none"> <li>• <b>Do not use flammable materials (e.g., hairspray or insecticide) near the remote controller.</b> Do not clean the product with organic solvents such as paint thinner. The use of organic solvents may cause cracking, damaging the product, causing electric shocks, or fire.</li> </ul>
	<ul style="list-style-type: none"> <li>• <b>Consult the dealer if the remote controller was submerged under water due to a natural disaster, such as a flood or hurricane.</b> <b>Do not operate the remote controller at this time or a malfunction, electric shock, or fire can occur.</b></li> </ul>

**—Items to be Strictly Observed—**

 <b>CAUTION</b>	
	<ul style="list-style-type: none"> <li>• <b>Do not allow children to play with the remote controller to avoid causing damage to the product.</b></li> </ul>
	<ul style="list-style-type: none"> <li>• <b>Never disassemble the remote controller.</b> Touching the interior parts may result in electric shocks or fire. Consult your Daikin dealer for internal inspections and adjustments.</li> </ul>
	<ul style="list-style-type: none"> <li>• <b>Do not touch the remote controller buttons with wet fingers.</b> <b>Touching the buttons with wet fingers can cause an electric shock.</b></li> </ul>
	<ul style="list-style-type: none"> <li>• <b>Do not wash the remote controller.</b> Doing so may cause electric leakage and result in electric shocks or fire.</li> </ul>
	<ul style="list-style-type: none"> <li>• <b>Never let the remote controller to get wet.</b> Water can cause damage to the remote controller, and may cause an electric shock or fire.</li> </ul>

 <b>NOTE</b>	
	<ul style="list-style-type: none"> <li>• <b>Never press the button of the remote controller with a hard and pointed object.</b> The remote controller may be damaged.</li> </ul>
	<ul style="list-style-type: none"> <li>• <b>Never pull or twist the electric wire of the remote controller.</b> It may cause the unit to malfunction.</li> </ul>
	<ul style="list-style-type: none"> <li>• <b>Do not wipe the remote controller with benzine, thinner, chemical dustcloth, etc.</b> The remote controller may get discolored or the coating peeled off. If it is heavily dirty, soak a cloth in water-diluted neutral detergent, squeeze it well and wipe the remote controller clean. And wipe it with another dry cloth.</li> </ul>

# Button Locations and Descriptions

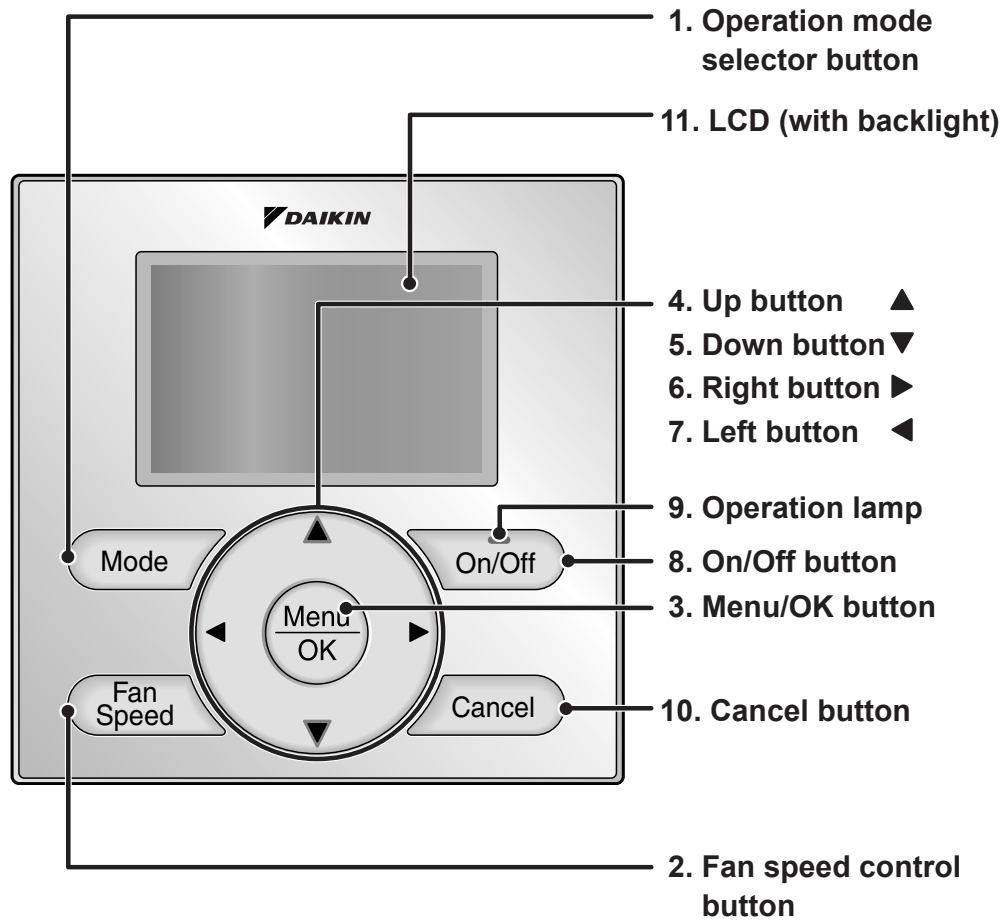

Functions other than basic operation items (i.e., On/Off, Operation Mode, Fan Speed, and Setpoint) are set from the menu screen.

**NOTE**

- Do not install the remote controller in places exposed to direct sunlight, the LCD will be damaged.
- Do not pull or twist the remote controller cord, the remote controller may be damaged.
- Do not use objects with sharp ends to press the buttons on the remote controller, damage may result.

### 1. Operation mode selector button

---

- Press this button to select the operation mode of your preference. **(See page 10.)**
- \* Available modes vary with the indoor unit model.

### 2. Fan speed control button

---

- Press this button to select the fan speed of your preference. **(See page 11.)**
- \* Available fan speeds vary with the indoor unit model.

### 3. Menu/OK button

---

- Used to enter the main menu. **(See page 20 for the menu items.)**
- Used to enter the selected item.

### 4. Up button ▲

---

- Used to raise the setpoint.
- The item above the current selection will be highlighted.  
(The highlighted items will be scrolled continuously when the button is continuously pressed.)
- Used to change the selected item.

### 5. Down button ▼

---

- Used to lower the setpoint.
- The item below the current selection will be highlighted.  
(The highlighted items will be scrolled continuously when the button is continuously pressed.)
- Used to change the selected item.

### 6. Right button ►

---

- Used to highlight the next items on the right-hand side.
- Each screen is scrolled in the right-hand direction.

### 7. Left button ◀

---

- Used to highlight the next items on the left-hand side.
- Each screen is scrolled in the left-hand direction.

### 8. On/Off button

---

- Press this button and system will start.
- Press this button again to stop the system.

### 9. Operation lamp

---

- This lamp illuminates solid green during normal operation.
- This lamp flashes if an error occurs.

### 10. Cancel button

---

- Used to return to the previous screen.

### 11. LCD (with backlight)

---

- The backlight will be illuminated for approximately 30 seconds by pressing any button.
- If two remote controllers are used to control a single indoor unit, only the controller accessed first will have backlight functionality.

# Names and Functions

## Liquid Crystal Display

- Three types of display mode (Standard, Detailed and Simple) are available.
- Standard display is set by default.
- Detailed and Simple displays can be selected in the main menu. (See page 40.)

### Standard display

- 10. Changeover controlled by the master indoor unit
- 9. Under centralized control

- 1. Operation mode
- 2. Fan Speed
- 6. Ventilation

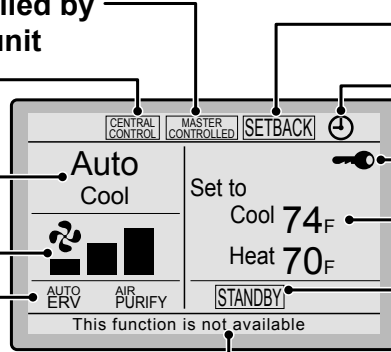

- 11. Setback
- 8. (⌚) Scheduled
- 7. (🔒) Key Lock
- 3. Setpoint
- 4. Stand by for Defrost/ Hot start
- 5. Message

<Standard display example>

### Detailed display

- The airflow direction, clock, and selectable item appear on Detailed display screen in addition to the items appearing on Standard display.

- 12. Airflow Direction (Displayed only when the indoor unit is turned on.)

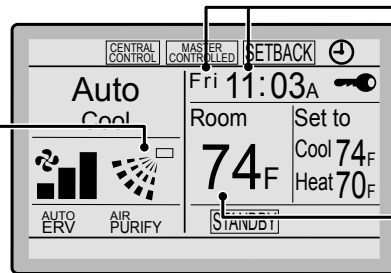

- 13. Current Day/Time (12/24 hour time display)
- 14. Selectable Display Item

<Detailed display example 1>

- No Fan speed display (with no fan speed control function)

- No Airflow Direction display (with no airflow direction settings)

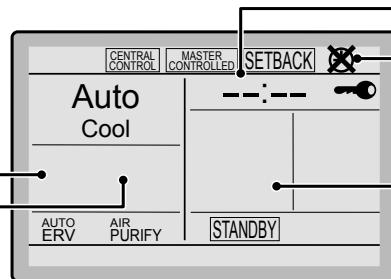

- No Clock display (when the clock has not been set yet)
- 15. (X) Unable to schedule
- No Selectable Display Item (with no selectable display item selected)

<Detailed display example 2>



**Simple display**

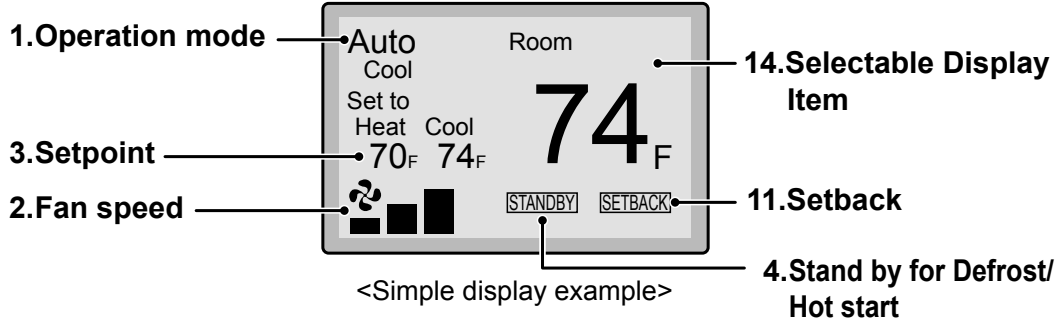

**Note for all display modes**

- Depending on the field settings, while the indoor unit is stopped, OFF may be displayed instead of the operation mode and/or the setpoint may not be displayed.

# Names and Functions

## 1. Operation mode

- Used to display the current operation mode: Cool, Heat, Vent, Fan, Dry or Auto.
- In Auto mode, the actual operation mode (Cool or Heat) will be also displayed.
- Operation mode cannot be changed when OFF is displayed. Operation mode can be changed after starting operation.

## 2. Fan Speed

- Used to display the fan speed that is set for the indoor unit.
- The fan speed will not be displayed if the connected model does not have fan speed control functionality.

## 3. Setpoint

- Used to display the setpoint for the indoor unit.
- Use the Celsius/Fahrenheit item in the main menu to select the temperature unit (Celsius or Fahrenheit).

## 4. Stand by for Defrost/Hot start

“” (See page 12.)

**If ventilation icon is displayed in this field:**

- Indicates that an energy recovery ventilator (ERV) is connected. For details, refer to the Operation Manual of the ERV.

## 5. Message

**The following messages may be displayed.**

“**This function is not available**”

- Displayed for a few seconds when an Operation button is pressed and the indoor unit does not provide the corresponding function.
- In a remote control group, the message will not appear if at least one of the indoor units provides the corresponding function.

“**Error: Push Menu button**”

“**Warning: Push Menu button**”

- Displayed if an error or warning is detected (see page 50).



“**Time to clean filter**”

“**Time to clean element**”

“**Time to clean filter & element**”

- Displayed as a reminder when it is time to clean the filter and/or element (see page 48).

## 6. Ventilation

- Displayed when an energy recovery ventilator is connected.
- **Ventilation Mode icon.** “ ” These icons indicate the current ventilation mode (ERV only) (AUTO, ERV, BYPASS).
- **Air Purify ICON** “ ” This icon indicates that the air purifying unit (Optional) is in operation.

## 7. Key Lock (See page 19.)

- Displayed when the key lock is set.

## 8. Scheduled (See page 30.)

- Displayed if the Schedule or Off timer is enabled.

## 9. Under Centralized control “”

- Displayed if the system is under the management of a multi-zone controller (Optional) and the operation of the system through the remote controller is limited.

## 10. Changeover controlled by the master indoor unit “” (VRV only)

- Displayed when another indoor unit on the system has the authority to change the operation mode between cool and heat.

### 11. Setback “” (See page 14.)

---

- The setback icon flashes when the unit is turned on by the setback control.

### 12. Airflow Direction “”

---

- Displayed when the airflow direction and swing are set (see page 23).
- If the connected indoor unit model does not include oscillating louvers this item will not be displayed.

### 13. Current Day/Time (12/24 hour time display)

---

- Displayed if the clock is set (see page 42).
- If the clock is not set, “-- : --” will be displayed.
- 12 hour time format is displayed by default.
- Select 12/24 hour time display option in the main menu under “Clock & Calendar”.

### 14. Selectable Display Item

---

- Room temperature is selected by default.
- For other choices see page 41.

### 15. Unable to schedule

---

- Displayed when the clock needs to be set.
- The schedule function will not work unless the clock is set.

# Basic Operation

## Cool/Heat/Auto/Fan Operation (SkyAir and VRV)

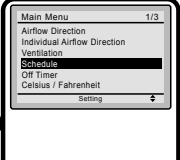
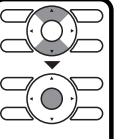
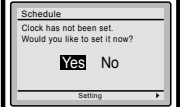
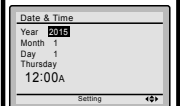
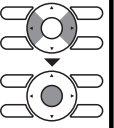
How to follow the operation manual	Operation procedure	Operation button display
<p><b>Operation screen display</b></p> <p>Describes screens that will be displayed on the remote controller in operation.</p>	<p><b>Operation procedure</b></p> <p>Explains the sequence of operation for the remote controller. Operate the buttons according to the procedure.</p>	<p><b>Operation button display</b></p> <p>Displays the location of buttons according to the procedure.</p>
<p><b>1</b></p> 	<ul style="list-style-type: none"> <li>• Display the main menu screen. (See page 22.)</li> <li>• Press <b>▼▲</b> buttons to select <b>Schedule</b> the main menu screen. Press <b>Menu/OK</b> button to display the timer screen.</li> </ul>	
<p><b>2</b></p>  	<ul style="list-style-type: none"> <li>• Before setting the schedule, the clock must be set.</li> <li>• If the clock has not been set, a screen like the one on the left will appear. Press <b>▶◀</b> buttons to select <b>Yes</b> and press <b>Menu/OK</b> button.</li> <li>• The date &amp; time screen will appear.</li> <li>• Set the current year, month, day, and time. (See clock settings on page 42.)</li> </ul>	

### Preparation

- For mechanical protection purposes, apply power to the outdoor units at least six hours before starting the operation of the system.

### Operation

**1**

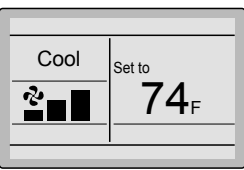

• Press **Mode** button several times until the desired mode Cool, Heat, Fan, or Auto mode is selected.

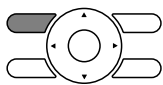

\* Unavailable operation modes are not displayed.

**Note**

- Both heat and cool mode may not be selected if the unit is master controlled. See page 16 if MASTER CONTROLLED icon flashes.

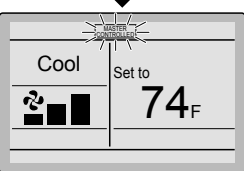

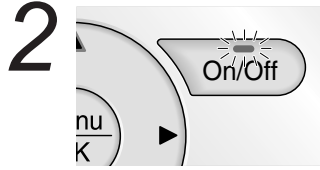

- Press **On/Off** button.  
The Operation lamp will illuminate solid green and the system will start operating.

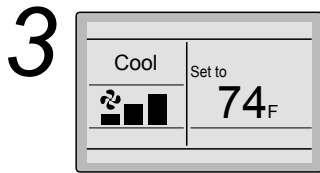
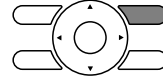

- The setpoint will increase by 1°F (or 1°C) when ▲ button is pressed and decrease by 1°F (or 1°C) when ▼ button is pressed.

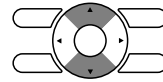

\* Setpoint is not available in fan or dry mode.

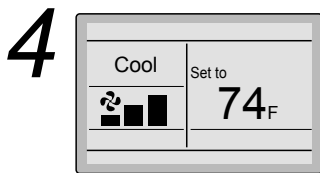

- To change the fan speed, press **Fan Speed** button and select the fan speed from;

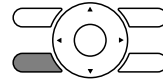

- Low/High/Auto for two-speed
- Low/Medium/High/Auto for three-speed
- Low/Med Low/Medium/Med High/High/Auto for five-speed depending on the indoor unit model.

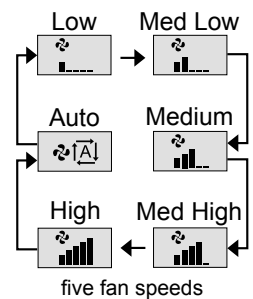
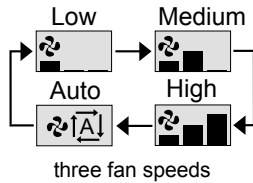

- \* Auto cannot be selected if the indoor unit does not have Auto Fan speed function.
- \* The system may change the fan speed automatically for equipment protection purposes.
- \* The system may turn off the fan when the room temperature is satisfied.
- \* It is normal for a delay to occur when changing the fan speed.
- \* If the Auto is selected for the fan speed, the fan speed varies automatically based on the difference between setpoint and room temperature.

# Basic Operation

5

- Adjust Airflow Direction from the main menu (see page 23).

\* If the connected indoor unit does not have oscillating louvers, this function will not be available.

6



- When **On/Off** button is pressed again, the system will stop operating and the Operation lamp will turn off.



\* When the system is stopped while in the heating mode, the fan will continue to operate for approximately one minute to remove residual heat from the indoor unit.

**Note**

- To prevent condensation water damage or system failure, do not shut off the power supply to the indoor unit immediately after operation. Wait at least five minutes for the condensate pump to finish draining residual water from the indoor unit.

## Characteristics of Heat Mode

The system automatically controls the following operating modes to prevent the reduction of heating capacity and space comfort.

**Defrost operation**

- The system will automatically go into defrost operation to prevent frost accumulation at the outdoor unit and subsequent loss of heating capacity.
- The indoor unit fan will stop, and “**STANDBY**” will be displayed on the remote controller.
- The system will finish the Defrost operation and return to normal usually within six to eight minutes. It won't last for more than ten minutes.

**Hot start**

- When the system starts heating operation, the indoor unit fan will operate with a delay in order to prevent a cold draft. (In that case, “**STANDBY**” will be displayed on the remote controller.)

# Dry Mode

## Preparation

- For equipment protection purposes, apply power to the outdoor units at least six hours before starting the operation of the system.
- The dry mode may not be selected if the remote controller is master controlled and the system is not already in the cooling mode of operation. (see page 18 for details)

## Operation

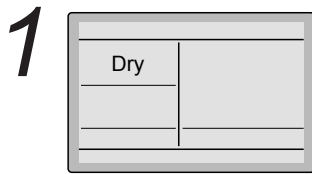

- Press **Mode** button several times until the Dry mode is selected.

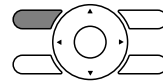

\* The dry mode may not be available depending on the type of indoor unit.



- Press **On/Off** button. The Operation lamp will illuminate solid green and the system will start operating.



\* In Dry mode, the system maintains automatic temperature and fan speed control. Therefore, temperature setpoint or fan speed settings are not available while the indoor unit is in the Dry mode.

3

- Adjust Airflow Direction from the main menu (see page 23).

\* If the connected indoor unit does not have oscillating louvers, this function will not be available.

# Basic Operation

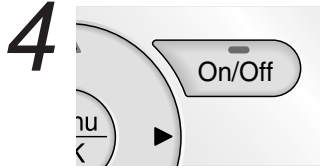

- When **On/Off** button is pressed again, the system will stop operating and the Operation lamp will turn off.



**Note**

- To prevent condensation water damage or system failure, do not shut off the power supply to the indoor unit immediately after operation. Wait at least five minutes for the condensate pump to finish draining residual water from the indoor unit.

## Characteristic of Dry mode

The Dry mode dehumidifies the space at reduced cooling capacity to prevent the room temperature from dropping to an uncomfortable level.

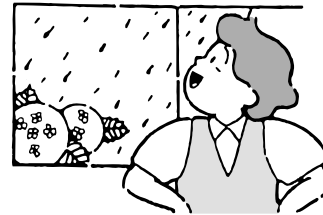

## Setback

The Setback function can be used to maintain the space temperature in an assigned range for an unoccupied period.

**Note**

- When enabled, the Setback mode becomes active when the indoor unit is turned off by either the user, a schedule event or an off timer.
- This function is not available by default. It can be enabled by the system installer.



**Operation**

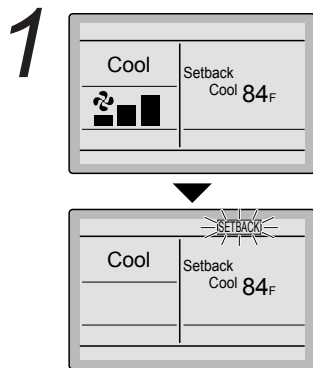

- The setback icon flashes when the unit is turned on by the setback control.

**Ventilation Mode** When the Indoor Unit is Interlocked with Energy Recovery Ventilator

**Preparation**

- For equipment protection purposes, apply power to the outdoor units at least six hours before starting the operation of the system.

**Operation**

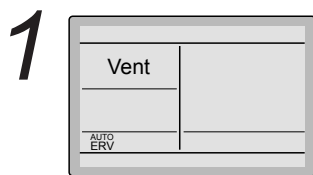

- When operating the energy recovery ventilator (ERV) between seasons without the indoor unit, set the control to ventilation mode.

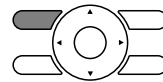

2

- Changes to the ventilation mode are made from the main menu.

\* Ventilation Mode: Auto, ERV, and Bypass

3

- Changes to the ventilation rate are made from the main menu.

\* Ventilation Rate: Low or High

# Basic Operation



- Press **On/Off** button.  
The Operation lamp will illuminate solid green and the system will start operating.



- When **On/Off** button is pressed again, the system will stop operating and the Operation lamp will turn off.



## Setting the Cool / Heat Changeover Master

(VRV only)

**Setting Changes** See page 18 for an explanation of the cool/heat changeover master indoor unit.

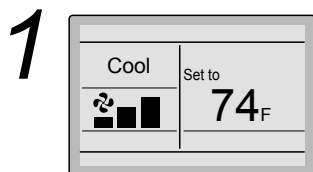

- Press **Mode** button on the remote controller of the changeover master indoor unit for at least four seconds while the backlight is illuminated.

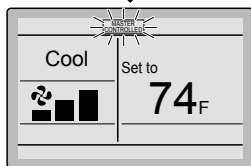
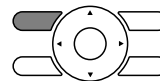

- The “**MASTER CONTROLLED**” icon on each remote controller for the indoor units connected to the same outdoor unit or Branch Selector unit will start flashing.
- \* Vent mode setting changes are possible regardless of the cool/heat changeover master indoor unit.  
\* If the outdoor unit is configured as cool/heat changeover master, all remote controllers serving the associated indoor units will display its “**MASTER CONTROLLED**” icon.
- Set the cool/heat changeover master indoor unit as outlined below.

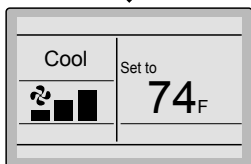
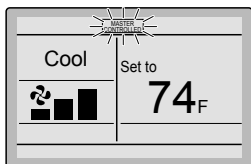

**Selection Settings** The icon "  " will flash on all remote controllers when the power is turned ON for the first time.

2





- Press **Mode** button on the remote controller of the indoor unit which is to serve as the cool/heat changeover master.

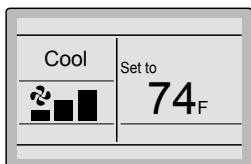

The remote controller for the changeover master indoor unit is established and the  icon is no longer displayed. Other remote controllers in the system (indoor units served by the same outdoor unit or indoor units served by the same branch selector unit) will now display the  icon.

3



- Press **Mode** button on the remote controller of the indoor unit designated as the cool/heat changeover master (the remote controller not displaying the  icon) repeatedly until the desired mode is selected. The display will change to **Fan, Dry, Auto, Cool, Heat** each time the button is pressed.
- Simultaneously, the other indoor units on the system will follow suit and change modes to reflect the new mode selected at the changeover master remote controller.



# Basic Operation

## Cool / Heat Mode Selection Availability

- “Cool”, “Heat”, and “Auto” are all only available for selection on the cool/heat changeover master indoor unit. The following table indicates the available operating modes of the other indoor units on the system based upon the selected mode of the master indoor unit.

When the master indoor unit is set to	The other indoor units in the system can be set to			
	Cool	Dry	Heat	Fan
Cool mode	✓	✓		✓
Dry mode	✓	✓		✓
Heat mode			✓	✓
Fan mode				✓
Auto mode (Cooling operation)	✓	✓		✓
Auto mode (Heating operation)			✓	✓

## Precautions for Selecting the Cool / Heat Changeover Master Indoor Unit

- The cool/heat changeover master must be set for a single indoor unit in the following applications

### (2-Pipe Heat Pump System)

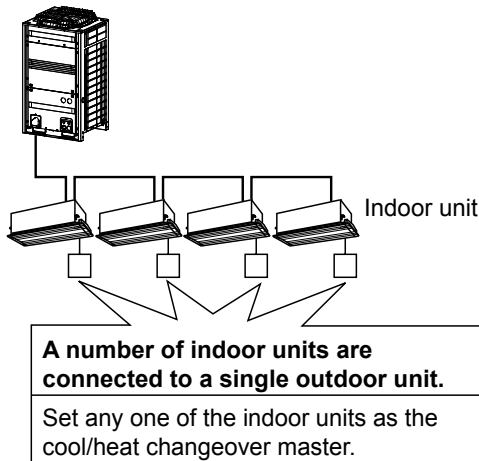

### (3-Pipe Heat Recovery System)

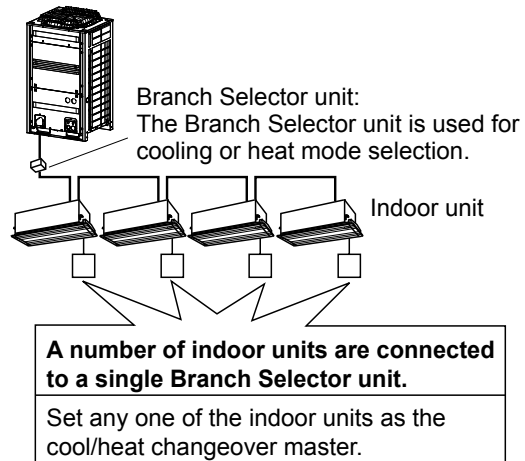

# Key Lock

**Operation** Confirm and cancel Key Lock settings in the basic display screen.

1

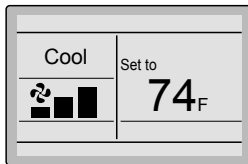

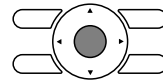

Basic screen

- Press **Menu/OK** button for at least four seconds while the backlight is illuminated.

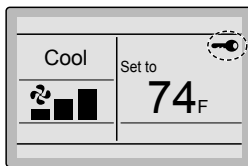

2



- “” is displayed. All buttons are disabled when the keys are locked.
- To cancel the key lock mode, continue pressing **Menu/OK** button for at least four seconds while the backlight is illuminated.

# Quick Reference

## ■ The main menu has the following items.

Menu item		Description	Reference page
<b>Airflow Direction</b>		<p><b>Used to configure airflow direction settings.</b></p> <ul style="list-style-type: none"> <li>The airflow direction louver is automatically operated up and down (left and right).</li> <li>The fixed airflow directions are configurable for five positions.</li> </ul> <p>* This function is not available on all indoor unit models.</p>	23
<b>Individual Airflow Direction</b> (depends on indoor unit model)	<b>Louver Setting</b>	<p>Set the airflow direction individually for each of the 4 louvers.</p> <ul style="list-style-type: none"> <li>Maximum 16 units (unit 0 till 15).</li> </ul>	25
	<b>Louver Setting List</b>	Setting table for louver.	26
	<b>Reset All Louvers Position</b>	Reset all louvers to factory default setting.	27
<b>Ventilation</b> (Ventilation operation settings for energy recovery ventilator)	<b>Ventilation Rate</b>	Used to set "Low" or "High"	28
	<b>Ventilation Mode</b>	Used to set Auto, ERV, or Bypass.	29
<b>Schedule</b>	<b>Daily Patterns</b>	<ul style="list-style-type: none"> <li>Day settings are selected from four patterns, i.e., "7Days", "Weekday/Sat/Sun", "Weekday/Weekend", and "Everyday".</li> </ul>	31
	<b>Settings</b>	<ul style="list-style-type: none"> <li>Set the startup time and operation stop time.                             <p>ON: Startup time, cooling and heating temperature setpoints can be configured.</p> <p>OFF: Operation stop time, cooling and heating setback temperature setpoints can be configured. ( --: Indicates that the setback function is disabled for this time period. )</p> <p>___: Indicates that the temperature setpoint and setback temperature setpoint for this time period is not specified. The last active setpoint will be utilized.</p> </li> <li>Up to five actions can be set for each day.</li> </ul>	32
<b>Off Timer</b>		<p><b>Used to set the run-time for the indoor unit using this controller.</b></p> <ul style="list-style-type: none"> <li>Possible to set in 10 minute increments from 30 to 180 minutes.</li> </ul>	35
<b>Celsius / Fahrenheit</b>		<ul style="list-style-type: none"> <li>Used to select whether temperature values will be displayed in Celsius or Fahrenheit.</li> </ul>	—

Menu item		Description	Reference page
<b>Filter Auto Clean</b>		Set the time when the filter needs to be automatically cleaned. For the detailed operation refer to the Operation Manual of the self cleaning decoration panel.	—
<b>Maintenance Information</b>		Used to display the maintenance information.	37
<b>Configuration</b>	<b>Draft Prevention</b> (Only available with Occ. sensor installed indoor unit model)	The draft prevention function can be <b>enabled</b> or <b>disabled</b> . When enabled, the Occ. sensor will adjust the louver's position to prevent air blowing directly on occupant.	38
	<b>Contrast Adjustment</b>	Used to make LCD contrast adjustment.	39
	<b>Display</b>	<b>Used to set the display mode.</b> <ul style="list-style-type: none"> <li>• Display mode Standard, Detailed, or Simple display</li> <li>• Detailed and Simple displays provide the selectable display item among Room Temp, System, None or Outside Air Temp.</li> </ul>	40
<b>Current Settings</b>		<ul style="list-style-type: none"> <li>• Used to display a list of current settings for available items.</li> </ul>	42
<b>Clock &amp; Calendar</b>	<b>Date &amp; Time</b>	<b>Used to configure date and time settings and corrections.</b> <ul style="list-style-type: none"> <li>• The default time display is 12H.</li> <li>• The clock will maintain accuracy to within ±30 seconds per month.</li> <li>• If there is a power failure for a period not exceeding 48 hours, the clock will continue working with the built-in backup power supply.</li> </ul>	42
	<b>12H/24H Clock</b>	The time can be displayed in either a 12 hour or a 24 hour time format.	45
<b>Daylight Saving Time</b>		Used to adjust the clock in observance of daylight saving time.	45
<b>Language</b>		The display language can be selected between <b>English, Francais, or Espanol.</b>	48

Note: Available setting items vary with the indoor unit model.

<b>Sub Remote Controller Menu Items</b>		
If two remote controllers are connected to a single indoor unit, the following menu items are not set in the sub remote controller. In this case, the following items should be configured in the main remote controller.		
<ul style="list-style-type: none"> <li>• Individual Airflow Direction</li> <li>• Schedule</li> <li>• Off timer</li> </ul>	<ul style="list-style-type: none"> <li>• Setback</li> <li>• Draft Prevention</li> </ul>	

# Menu Options

## Navigating the Main Menu Screen

### ■ Display Method for Main Menu

#### Operation

**1**

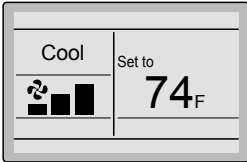

Basic screen

• Press **Menu/OK** button.



**2**

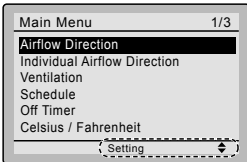

Main menu screen

• The main menu screen is displayed.

⇐ Instructions for navigating the main menu will appear.

**3**

- Selecting items from the main menu.
  1. Press ▼▲ buttons to select the desired item to be set.
  2. Press **Menu/OK** button to display the details for the selected item.

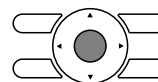
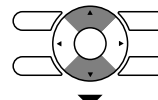

**4**

• To go back to the basic screen from the main menu, press **Cancel** button.



#### Note

- If a button is not pressed for 5 minutes during configuration, the controller will automatically revert to the basic screen.



# Airflow Direction

## ■ Configuring Airflow direction

### Operation

1

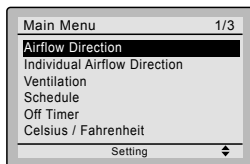

- Display the main menu screen. (See page 22.)
- Press ▼▲ buttons to select **Airflow Direction** and press **Menu/OK** button.

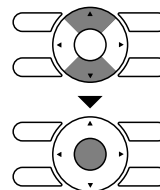

2

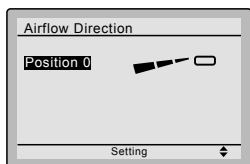

(1) Adjusting method when there is single airflow direction.

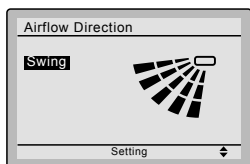
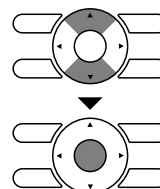

Airflow direction setting (up/down)

- Select the desired airflow direction from **Position 0** , **Position 1** , **Position 2** , **Position 3** , **Position 4** , **Swing** or **Auto** using ▼▲ buttons.
- Press **Menu/OK** button to confirm the settings and to return to the basic screen.

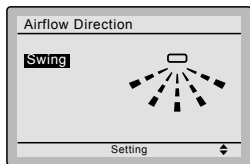

Airflow direction setting (left/right)

**Note**

- The airflow directions appear on the screen as follows:

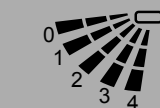

Up/down direction

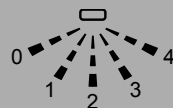

Left/right direction

- 0 : Position 0
- 1 : Position 1
- 2 : Position 2
- 3 : Position 3
- 4 : Position 4

**Notice**

These operation and screen are example of single airflow direction type indoor unit. It is different from Single flow cassette model.

# Menu Options

3

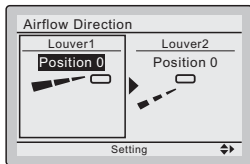

When front/back direction is selected

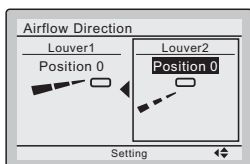

When left/right direction is selected

(2) Adjusting method for selecting dual airflow directions.

- Press ◀▶ buttons, to select front/back or left/right direction setting.



**Notice**

These operation and screen are example of dual airflow directions type indoor unit (Single flow cassette model).

4

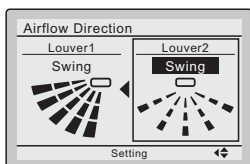
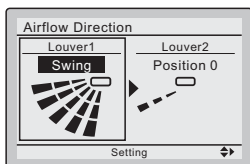
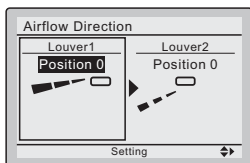

- Select the desired airflow direction from **Position 0** , **Position 1** , **Position 2** , **Position 3** , **Position 4** , **Swing** or **Auto** using ▼▲ buttons.

- Selecting **Swing** will cause the airflow direction louver to swing position 0 to 4.
- Setting **Auto** is not available when left/right direction is selected.

- Press **Menu/OK** button to confirm the settings and return to the basic screen.

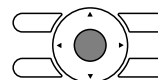

5

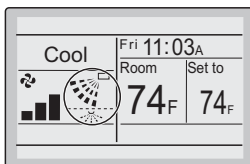

Basic screen (Detailed display)

- If dual airflow directions are set, then the dual airflow direction icons are displayed in the basic screen.

# Individual Airflow Direction

## ■ Louver Setting

### Operation

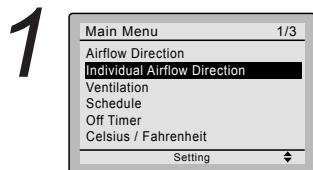

- Display the main menu screen. (See page 22.)
- Select **Individual Airflow Direction** and press **Menu/OK** button.

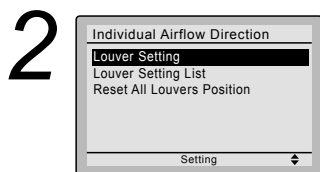
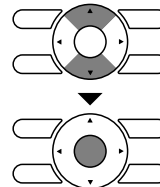

- Select **Louver Setting** and press **Menu/OK** button.

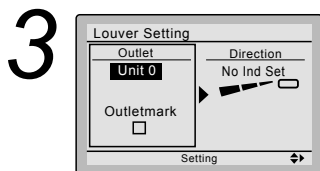
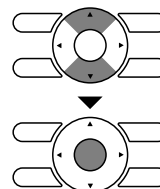

- Use ▼▲ buttons to select the unit and outlet mark.
- Maximum 16 units for each group (unit 0 till 15) can be selected.

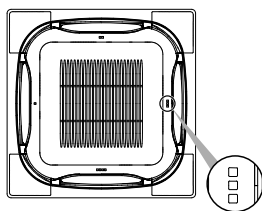

**Note**

In case of four outlets (cassette type), you can control each one of the four louvers individually (the following marks are beside each air outlet: □, □□, □□□, □□□□).

# Menu Options

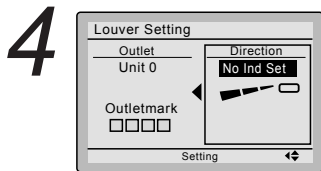

- Press ◀▶ button to select the airflow direction.
- Use ▼▲ buttons to change the airflow direction to the following:  
**No Ind Set** , **Position 0** , **Position 1** ,  
**Position 2** , **Position 3** , **Position 4** ,  
**Swing** or **Blocked** .  
**No Ind Set** : No Individual Louver Setting.  
**Blocked** : Individual airflow is blocked.
- Press **Menu/OK** button to confirm the settings and to return to the basic screen.

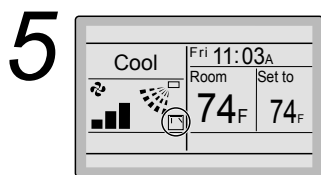
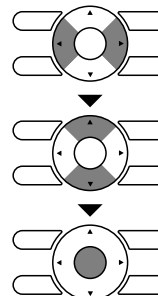

Basic screen  
(Detailed display)

- If individual airflow direction is set, then the individual airflow direction icon is displayed in the basic screen.

## ■ Louver Setting List

### Operation

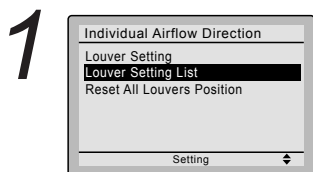

- Display the individual airflow direction screen. (See page 25.)
- Press ▼▲ buttons to select **Louver Setting List** and press **Menu/OK** button.

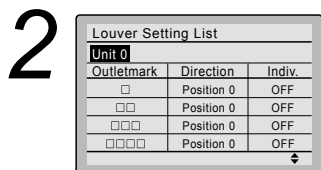
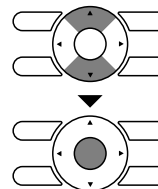

- A table shows the current settings. Press ▼▲ buttons to go to the next unit.
- Press **Cancel** button to return to the previous menu.

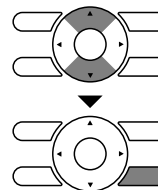

## ■ Reset All Louvers Position

### Operation

1

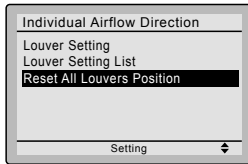

- Display the individual airflow direction screen.  
(See page 25.)
- Press ▼▲ buttons to select **Reset All Louvers Position** and press **Menu/OK** button.

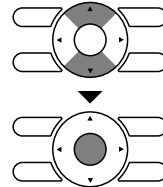

2

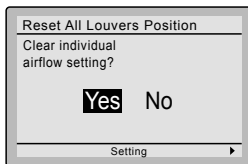

- Press ◀▶ buttons to select **Yes**.
- Press **Menu/OK** button to confirm the reset and to return to the basic screen.

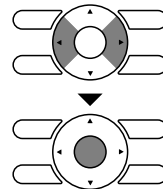

## Operational Details and Functions

There are two types of airflow direction settings.

### Airflow direction swing

The louvers automatically oscillate up and down.

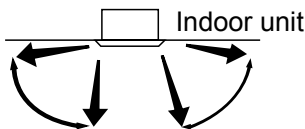

(Automatic swing)

(Automatic swing)

### Airflow direction

You can select from one of five fixed directions. (This has no relation to the angle of the louvers.)

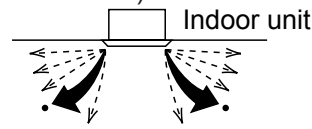

(Desired position)

(Desired position)

### Movement of airflow direction louver

Under the operating conditions shown next, airflow direction is controlled automatically. Actual operation may be different than what is displayed on the remote controller.

# Menu Options

<b>Operating condition</b>	<ul style="list-style-type: none"> <li>• Room temperature is higher than the remote controller's setpoint (in heating operation).</li> <li>• When defrosting (in heating operation). (The airflow discharges horizontally to avoid creating a draft for the room occupants.)</li> <li>• Under continuous operation with the airflow discharging horizontally.</li> </ul>
----------------------------	--

## Ventilation

### ■ Ventilation screen display properties

#### Operation

1

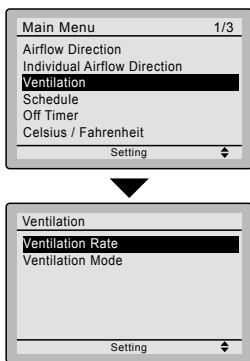

- Display the main menu screen.  
(See page 22.)
- Press ▼▲ buttons to select **Ventilation** on the main menu screen.  
(For models with no ventilation function, **Ventilation** will not be displayed on the main menu screen.)  
Press **Menu/OK** button to display the ventilation screen.

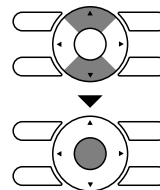

### ■ Changing the ventilation rate

#### Operation

1

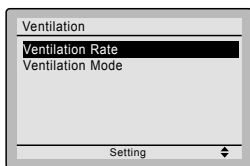

- Navigate to the ventilation screen  
(see above).
- Press ▼▲ buttons to select **Ventilation Rate** on the ventilation screen.  
Press **Menu/OK** button to display the ventilation rate screen.

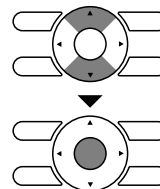

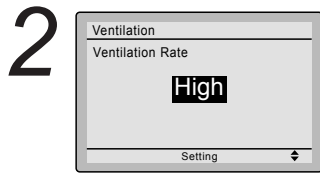

- Press ▼▲ buttons to toggle between the **Low** and **High** settings.

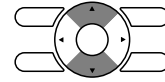

\* Only modes that can be set are displayed.

3

- Selecting and confirming the desired ventilation rate will take you back to the basic screen.

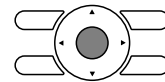

(Pressing **Cancel** button takes you back to the previous screen without changing the ventilation rate.)

## ■ Changing the ventilation mode

### Operation

1

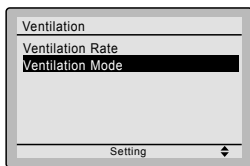

- Display the ventilation screen. (See page 28.)
- Press ▼▲ buttons to select **Ventilation Mode** on the ventilation screen. Press **Menu/OK** button to display the ventilation mode screen.

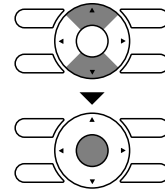

2

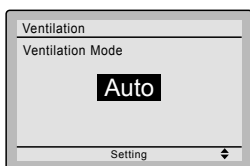

- Pressing ▼▲ buttons cycles through the settings in the order shown below.

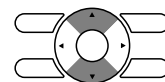

\* Only modes that can be set are displayed.

# Menu Options

3

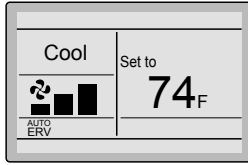

- Selecting and confirming the desired ventilation mode will take you back to the basic screen.  
(Pressing **Cancel** button takes you back to the previous screen without changing the ventilation mode. )



## Ventilation Mode

### Auto mode

Using information from the indoor unit (cool, heat, fan, and setpoint) and the energy recovery ventilator unit (indoor and outdoor temperatures), the ventilation mode is automatically changed between ERV and Bypass.

### ERV mode

Outside air is passed through the ERV core and is supplied to the conditioned space.

### Bypass mode

Outside air is supplied to the conditioned space without passing through the ERV core.

## Schedule

### ■ Setting the schedule

**Operation** The schedule will disappear when a multizone controller is connected, but can be re-enabled by the system installer.

1

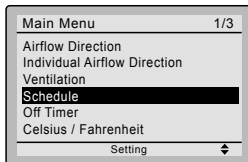

- Display the main menu screen.  
(See page 22.)
- Press ▼▲ buttons to select **Schedule**.  
Press **Menu/OK** button to display the schedule screen.

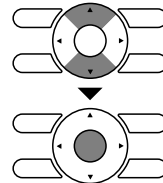



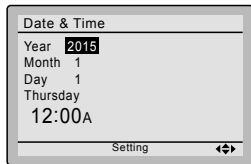
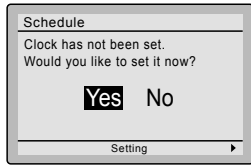

- Before setting the schedule, the clock must be set.
- If the clock has not been set, a screen like the one on the left will appear. Press ◀▶ buttons to select **Yes** and press **Menu/OK** button.
- The date & time screen will appear.
- Set the current year, month, day, and time. (See clock settings on page 42.)

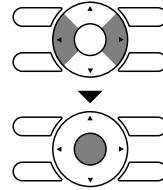

2

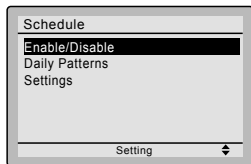

- Press ▼▲ buttons to select the desired function on the schedule screen and press **Menu/OK** button.

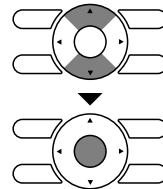

## ■ Daily Patterns

### Operation

1

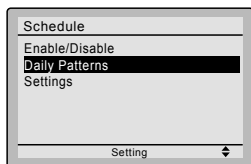

- The schedule screen will appear.
- Press ▼▲ buttons to select **Daily Patterns** on the schedule screen. The daily patterns screen will appear when **Menu/OK** button is pressed.

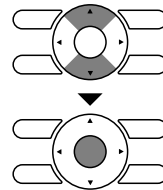

2

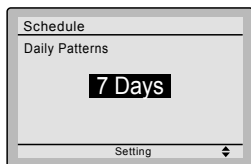

- Press ▼▲ buttons to select **7 Days**, **Weekday/Sat/Sun**, **Weekday/Weekend** or **Everyday** on the daily patterns screen. The confirmation screen will appear when **Menu/OK** button is pressed.

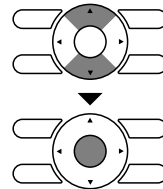

# Menu Options

3

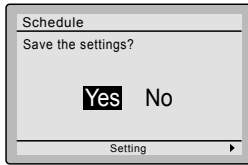

- Press ◀▶ buttons to select **Yes** on the confirmation screen.
- Pressing **Menu/OK** button enters the daily patterns in the schedule and takes you back to the main menu screen.

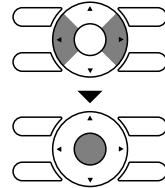

## ■Settings

### Operation

1

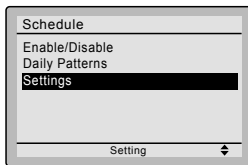

- The schedule screen will appear.
- Press ▼▲ buttons to select **Settings** on the schedule screen.
- The settings screen will appear when **Menu/OK** button is pressed.

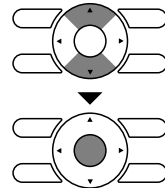

2

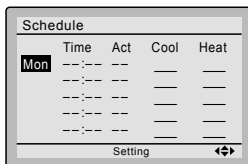

- Press ▼▲ buttons to select the day to be set.
- \* It cannot be selected in the case of **EVDY**.

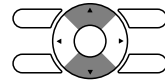

3

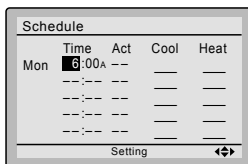

- Input the time for the selected day.
- Press ◀▶ buttons to move the highlighted item and press ▼▲ buttons to input the desired operation start time.
- Each press of ▼▲ buttons moves the numbers by 1 hour or 1 minute.

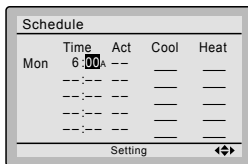
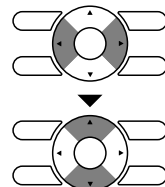

4

Schedule				
	Time	Act	Cool	Heat
Mon	6:00a	Act		
	--:--			
	--:--			
	--:--			
	--:--			
Setting				

Schedule				
	Time	Act	Cool	Heat
Mon	6:00a	ON	90F	60F
	--:--			
	--:--			
	--:--			
	--:--			
Setting				

- Press ◀▶ buttons to move the highlighted item and press ▼▲ buttons to configure ON/OFF/-- settings. --, ON, or OFF changes in sequence when ▼▲ buttons are pressed.

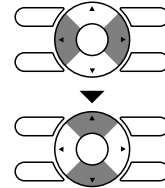

- ON: The temperature setpoints can be configured.
- OFF: The setback temperature setpoints can be configured.
- : The temperature setpoints and setback temperature setpoints become disabled.

Schedule				
	Time	Act	Cool	Heat
Mon	6:00a	ON	75F	70F
	8:00a	OFF	75F	
	--:--			
	--:--			
	--:--			
Setting				

- The cooling and heating temperature setpoints for both ON and OFF (Setback) are configured.

- \_: Indicates that the temperature setpoint and setback temperature setpoint for this time period is not specified. The last active setpoint will be utilized.
- : Indicates that the setback function is disabled for this time period.

5

Schedule				
	Time	Act	Cool	Heat
Mon	6:00a	ON	75F	70F
	8:00a	OFF	85F	50F
	5:30p	ON	75F	70F
	10:00p	--		
	--:--			
	--:--			
Setting				

Schedule				
	Time	Act	Cool	Heat
Mon	6:00a	ON	75F	70F
	8:00a	OFF	85F	50F
	5:30p	ON	75F	70F
	10:00p	OFF	82F	62F
	--:--			
	--:--			
Setting				

Schedule				
	Time	Act	Cool	Heat
Tue	6:00a	ON	75F	70F
	8:00a	OFF	85F	50F
	5:30p	ON	75F	70F
	10:00p	OFF	82F	62F
	--:--			
	--:--			
Setting				

A maximum of five actions per day can be set.

- Press **Menu/OK** button when settings for each day are completed. The confirmation screen will appear.

To copy the settings for the previous day, press **Mode** button so that the existing settings will be copied.  
Example: The contents for Monday are copied by pressing **Mode** button after selecting Tuesday.

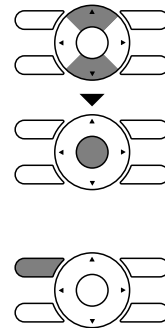

# Menu Options

6

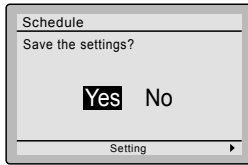

- Press ◀▶ buttons to select **Yes** on the confirmation screen. Pressing **Menu/OK** button confirms the settings for each day and takes you back to the basic screen.

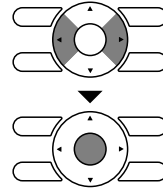

## Enabling or disabling the schedule

### Operation

1

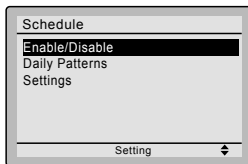

- Display the schedule screen. (See page 30.)
- Press ▼▲ buttons to select **Enable / Disable** on the schedule screen. Press **Menu/OK** button to display the enable/disable screen.

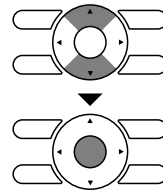

2

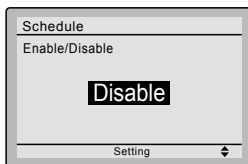

- Press ▼▲ buttons to select **Enable** or **Disable** on the enable/disable screen. Press **Menu/OK** button after selecting the item. The confirmation screen is displayed.

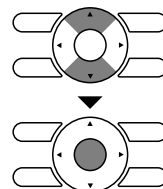

3

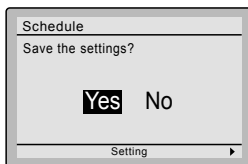

- Press ◀▶ buttons to select **Yes** on the confirmation screen. Pressing **Menu/OK** button confirms the enable/disable setting for the schedule and takes you back to the basic screen.

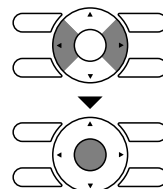

# Off Timer

## ■ Configuring and Confirming the Off Timer settings

### Operation

1

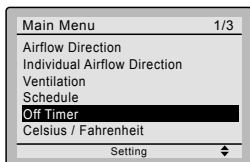

- Display the main menu screen.

(See page 22.)

- Press ▼▲ buttons to select the **Off Timer** on the main menu screen. Press **Menu/OK** button to display the off timer screen.

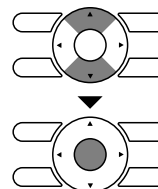

2

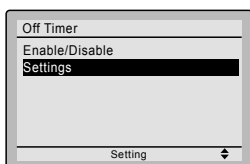

- Press ▼▲ buttons to select **Settings** on the off timer screen. Press **Menu/OK** button to display the configuration screen.

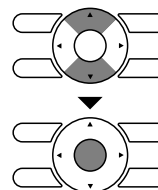

3

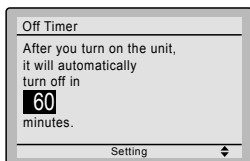

- Use ▼▲ buttons to set the time from operation start until the unit automatically stops. Selections can be made in increments of 10 minutes from 30 to 180 minutes. Holding down the button causes the number to change continuously.
- Select the desired time and press **Menu/OK** button. The confirmation screen will appear.

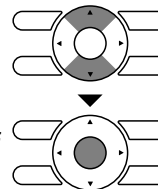

4

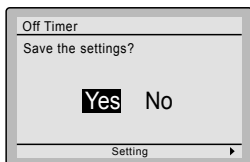

- Press ◀▶ button to select **Yes** on the confirmation screen. Pressing **Menu/OK** button confirms the off timer and takes you back to the basic screen.

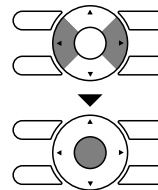

# Menu Options



## Enabling or disabling the off timer

### Operation

1

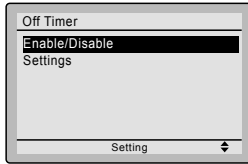

- Navigate to the off timer screen. (See page 35.)
- Press ▼▲ buttons to select **Enable/Disable** on the off timer screen. Press **Menu/OK** button to display the enable/disable screen.

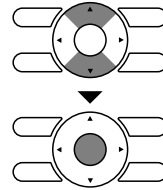

2

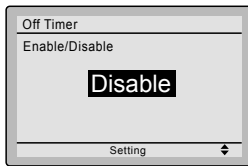

- Press ▼▲ buttons to select **Enable** or **Disable** on the enable/disable screen. Press **Menu/OK** button after selecting the item. Then the confirmation screen is displayed.

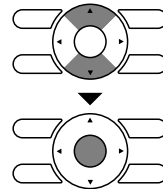

3

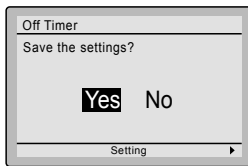

- Press ◀▶ button to select **Yes** on the confirmation screen. Pressing **Menu/OK** button confirms the enable/disable for the off timer and takes you back to the basic screen.

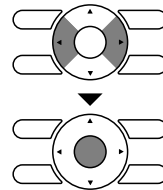

# Maintenance Information

## ■ Displaying the service contact and model information

### Operation

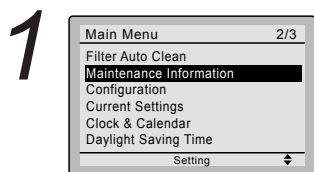

- Display the main menu screen. (See page 22.)
- Press ▼▲ buttons to select **Maintenance Information** on the main menu screen and press **Menu/OK** button.

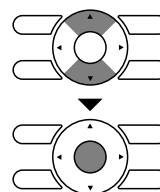

- The phone number for the contact is displayed at the top of the screen. (If it has not yet been entered, it will not be displayed.)
  - The model information of the indoor and outdoor units for your product will be displayed on the bottom of the screen. (For some models the product code may be displayed.)
- \* The model name will not be displayed if the indoor unit PCB has been replaced.

\* The error code history may also be displayed. If the Operation lamp is not flashing, the unit is working properly. The error code history is no longer displayed if you press **On/Off** button for more than 4 seconds.



# Menu Options

## Configuration

### ■ Draft Prevention

#### Operation

- 1

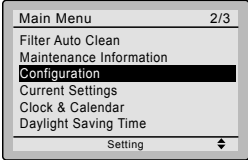

- Display the main menu screen.  
(See page 22.)
  - Press ▼▲ buttons to select **Configuration** and press **Menu/OK** button.

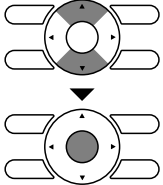

---

- 2

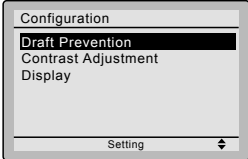

- Press ▼▲ buttons to select **Draft Prevention** and press **Menu/OK** button.

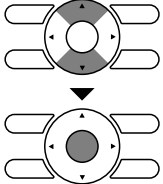

---

- 3

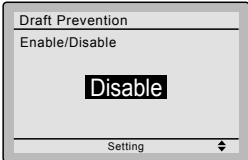

- Press ▼▲ buttons to select **Enable** or **Disable** .
  - The confirmation screen will appear when **Menu/OK** button is pressed.

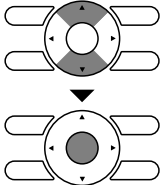

---

- 4

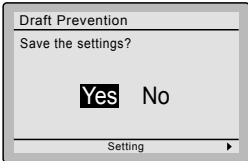

- Press ◀▶ buttons to select **Yes** .
  - Press **Menu/OK** button to confirm the settings and to return to the basic screen.

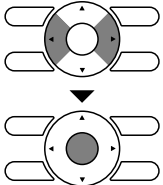



## ■ Contrast Adjustment

### Operation

1

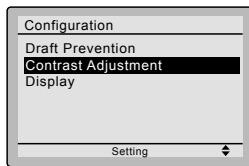

- Navigate to the configuration screen. (See page 38.)
- Press ▼▲ buttons to select **Contrast Adjustment** on the configuration screen. Press **Menu/OK** button to display the contrast adjustment screen.

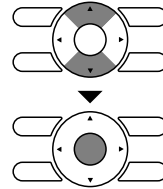

2

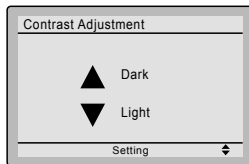

- On the contrast adjustment screen press ▼▲ buttons until you reach the desired contrast. After setting, press **Menu/OK** button and return to the basic screen.

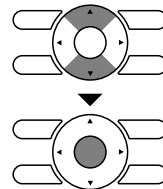

# Menu Options

## ■ Display Display Mode

### Operation

1

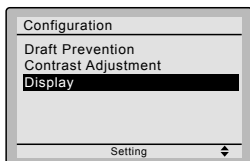

- Navigate to the configuration screen.  
(See page 38.)
- Press ▼▲ buttons to select **Display** on the configuration screen. Press **Menu/OK** button to display the display screen.

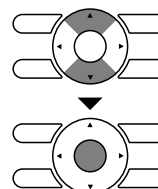

2

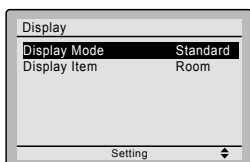

- Press ▼▲ buttons to select **Display Mode** on the display screen. Press **Menu/OK** button to display the display mode screen.

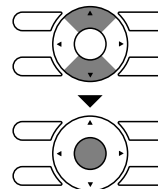

3

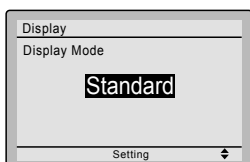

- Press ▼▲ buttons to select **Standard**, **Detailed** or **Simple** on the display screen.
- Press **Menu/OK** button to confirm the settings and return to the basic screen.

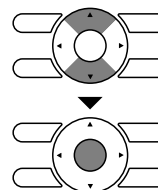

\* Refer to **Display Item** to change the selectable display item for Detailed and Simple display modes. (See page 41.)

# Display Item

## Operation

1

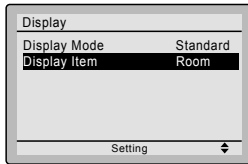

- Navigate to the display screen.  
(See page 40.)
- Press ▼▲ buttons to select **Display Item** on the display screen. Press **Menu/OK** button to display the display item screen.

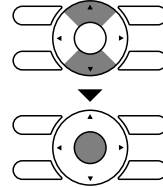

2

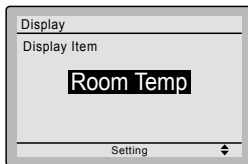

- Pressing ▼▲ buttons displays the following.

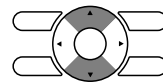

\* Some models may not display these items even if they are selected.

- Be sure to read the following notes regarding display of room temperature and outside air temperature.

### Room Temp

..... The temperature at the remote controller.  
The temperature that is detected may be affected by the location of the remote controller.

### Outside Air Temp

..... The temperature at the outdoor unit.  
The temperature that is detected may be affected by factors such as the location of the unit (for example, if it is in direct sunlight) and unit operation during defrosting.

- After setting, press **Menu/OK** button to confirm settings and return to the basic screen.

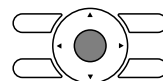

# Menu Options

## Current Settings

### Confirming the current settings

#### Operation

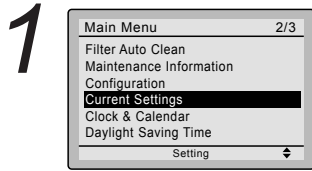

- Display the main menu screen. (See page 22.)
- Press ▼▲ buttons to select **Current Settings** on the main menu screen and press **Menu/OK** button.

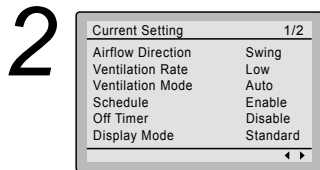
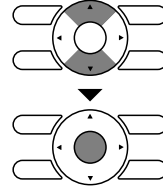

- A list showing the current setting status will appear. Press ◀▶ buttons to go to the next item.
- Pressing **Cancel** button takes you back to the main menu screen.

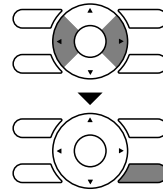

Display items	
Airflow Direction	Off Timer
Ventilation Rate	Display Mode
Ventilation Mode	Display Item
Schedule	Filter Auto Clean

\* Display items may differ depending on the model. Only the items that can be set are displayed.

## Clock & Calendar

### Date & Time

#### Operation

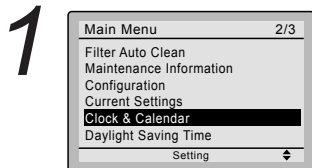

- Display the main menu screen. (See page 22.)
- Press ▼▲ buttons to select **Clock & Calendar** on the main menu screen. Press **Menu/OK** button to display the clock & calendar screen.

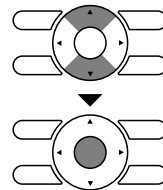

**2**

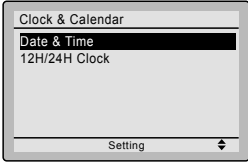

- Press ▼▲ buttons to select **Date & Time** on the clock & calendar screen. Press **Menu/OK** button to display the date & time screen.

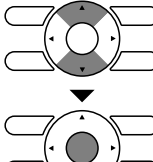

**3**

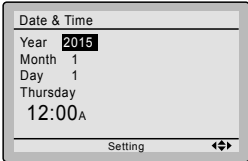

- Select **Year** with ◀▶ buttons. Change the year with ▼▲ buttons. Holding down the button causes the number to change continuously.

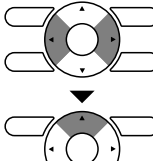

**4**

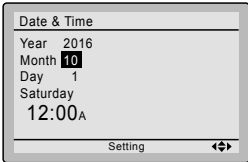

- Select **Month** with ◀▶ buttons. Change the month with ▼▲ buttons. Holding down the button causes the number to change continuously.

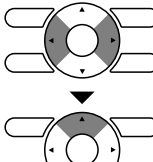

**5**

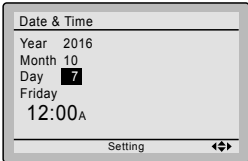

- Select **Day** with ◀▶ buttons. Change the day with ▼▲ buttons. Holding down the button causes the number to change continuously. Days of the week change automatically.

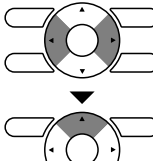

**6**

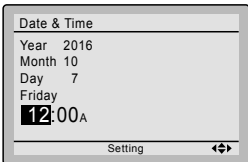

- Select **Hour** with ◀▶ buttons. Change the hour with ▼▲ buttons. Holding down the button causes the number to change continuously.

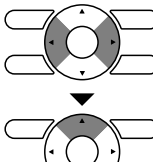

# Menu Options

7

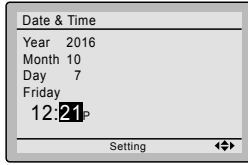

- Select **Minute** with ◀▶ buttons. Change the minute with ▼▲ buttons. Holding down the button causes the number to change continuously.
- Press **Menu/OK** button. The confirmation screen will appear.

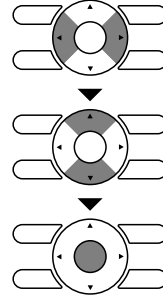

Note:

The date can be set between January 1, 2015 and December 31, 2099.

8

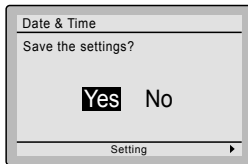

- Press ◀▶ button to select **Yes** on the confirmation screen. Press **Menu/OK** button to confirm the clock and return to the basic screen.

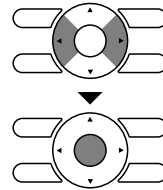

\* When setting the schedule, the display returns to the settings screen.

## ■ 12H/24H CLOCK

### Operation

1

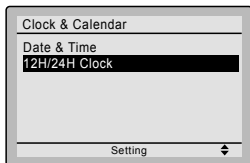

- Display the clock & calendar screen. (See page 42.)
- Press ▼▲ buttons to select **12H/24H Clock** on the clock & calendar screen. The 12H/24H clock screen will appear when **Menu/OK** button is pressed.

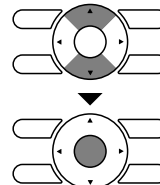

2

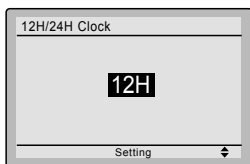

- By default, the time display is set to the 12H format.
- Press ▼▲ buttons to select **12H** **24H** on the 12H/24H clock screen.
- The confirmation screen will appear when **Menu/OK** button is pressed.

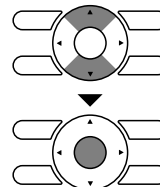

3

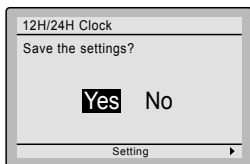

- Press ◀▶ buttons to select **Yes** on the confirmation screen. Pressing **Menu/OK** button confirms the 12H or 24H and takes you back to the basic screen.

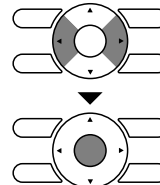

## Daylight Saving Time

### ■ How to display Daylight Saving Time

#### Operation

1

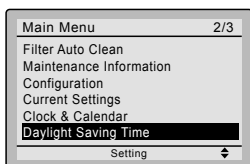

- Display the main menu screen. (See page 22.)
- Press ▼▲ buttons to select **Daylight Saving Time** on the main menu screen. Press **Menu/OK** button to display the daylight saving time screen.

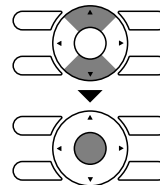

# Menu Options

## Enabling or disabling Daylight Saving Time

### Operation

1

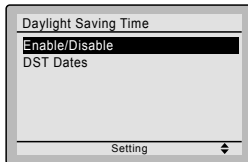

- Display the daylight saving time screen. (See page 45.)
- Press ▼▲ buttons to select **Enable/Disable** on the daylight saving time screen. Press **Menu/OK** button to display the enable/disable screen.

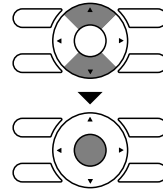

2



- Press ▼▲ buttons to select **Enable** or **Disable** on the enable/disable screen.
- Press **Menu/OK** button to display the setting confirmation screen.

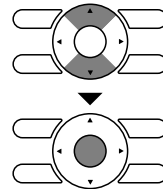

3

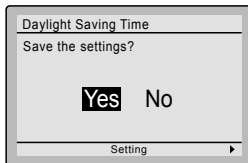

- Press ◀▶ buttons to select **Yes** on the setting confirmation screen. Pressing **Menu/OK** button confirms the daylight saving time enable/disable setting and takes you back to the basic screen.

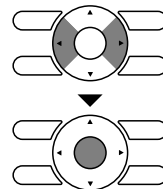

## Setting the date

### Operation

1

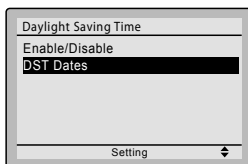

- Display the daylight saving time screen. (See page 45.)
- Press ▼▲ buttons to select **DST Dates** on the daylight saving time screen. Press **Menu/OK** button to display the duration setting screen.

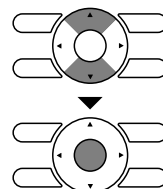



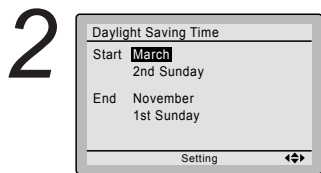

- Press ▼▲ buttons to select the start month and the end month.
- Press ◀▶ buttons to select a week. Press ▼▲ buttons to select the start week and the end week.

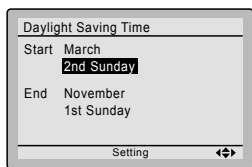
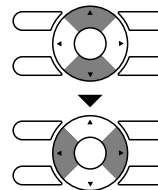

- After setting the Start and End dates, press **Menu/OK** button to display the setting confirmation screen.

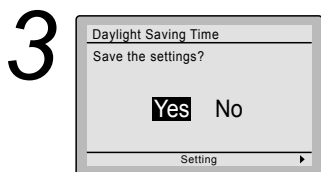
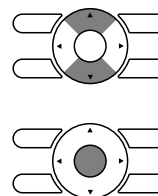

- Press ◀▶ buttons to select **Yes** on the setting confirmation screen. Pressing **Menu/OK** button confirms the Daylight Saving Time settings and takes you back to the basic screen.

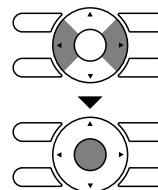

### When Daylight Saving Time is enabled

When the time in the remote controller reaches 2:00 a.m. on the specified start date, the clock is automatically set forward by one hour. When the time in the remote controller reaches 2:00 a.m. on the end date, the clock is automatically set back by one hour.

# Menu Options

## Language

### Selectable Languages

#### Operation

1

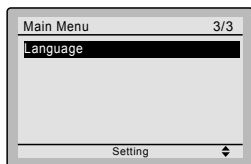

- Display the main menu screen. (See page 22.)
- Press ▼▲ buttons to select **Language** on the main menu screen and press **Menu/OK** button.

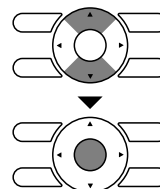

2



- Press ▼▲ buttons to select the preferred language on the language screen. **English/Français/Español** are available.
- Press **Menu/OK** button to confirm the settings and return to the basic screen.

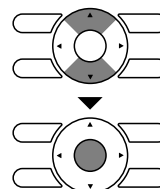

# Maintenance

## Reset Filter Indicator

#### Operation

1

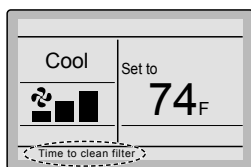

- When it is time to clean or replace the filter, one of the following messages will be displayed on the bottom of the basic screen.

- Time to clean filter**
- Time to clean filter & element**
- Time to clean element**

\* This is not displayed when Simple display is set.

- Wash, clean, or replace the filter or element.  
For details, refer to the operation manual supplied with the indoor unit.

2

- Reset the filter indicator when the filter or element is cleaned or replaced.
- Press **Menu/OK** button.  
The main menu screen will be displayed.



3

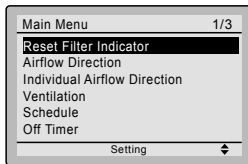

- Press ▼▲ buttons to select **Reset Filter Indicator** on the main menu screen and press **Menu/OK** button.

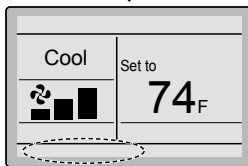
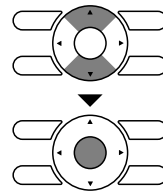

- The displayed message “Time to clean filter” is no longer displayed on the basic screen when the filter sign is reset.

## Maintaining the Unit and LCD Display

- Wipe the LCD and surface of the remote controller with a dry cloth when they become dirty.
  - If the dirt on the surface cannot be removed, soak the cloth in neutral detergent diluted with water, squeeze the cloth tightly, and clean the surface. Wipe the surface with a dry cloth.
- Note**
- Do not use any paint thinner, organic solvent, or strong acid.

# Reference Information

## Error Code Display

■ Contact your Daikin dealer in the following cases

### Operation

1

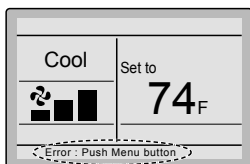

• If an error occurs, either one of the following items will flash in the basic screen.

**Error: Push Menu button**

- \* The Operation lamp will flash.
- \* For Simple display, the message is not displayed, and only the Operation lamp flashes.

**Warning: Push Menu button**

- \* The Operation lamp will not flash.
- \* For Simple display, the message is not displayed, and the Operation lamp does not flash, either.

• Press **Menu/OK** button.

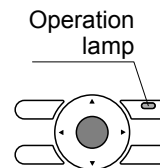

2

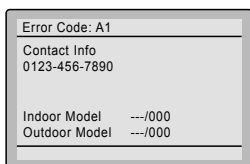

- The error code will flash and the service contact and model name or code may be displayed.
- Notify your Daikin dealer of the Error code and model name or code.

## After-sale Service

### Warning

- **Do not relocate or reinstall the remote controller by yourself.**  
Improper installation may result in electric shocks or fire.  
Consult your Daikin dealer.



### ■ Advise your Daikin Dealer of the following items

- Model name
- Date of installation
- Failure conditions: As precise as possible.
- Your address, name, and telephone number

### ■ Repairs after Warranty Period

Consult your Daikin dealer.

### ■ Inquiry about After-sale Service

Contact your Daikin dealer.

### 13.8 <BRC082A43> Wireless Remote Controller for FDMQ

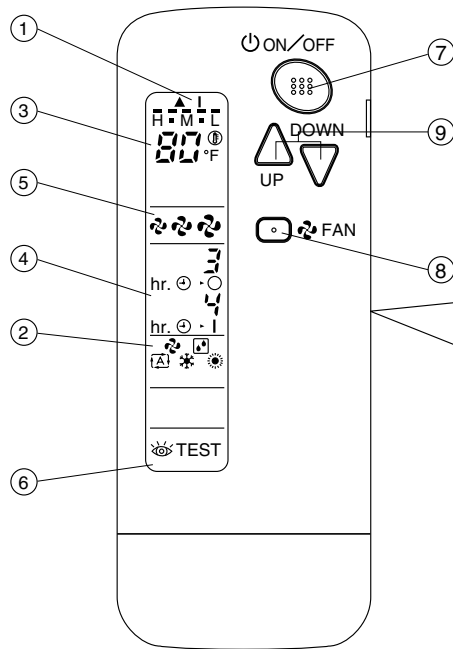

Fig. 1-1

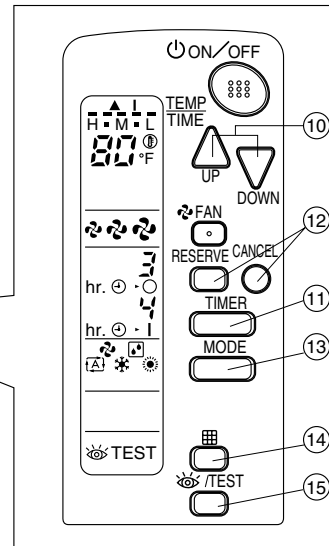

Fig. 1-2

The situation which opened the front cover of the remote control

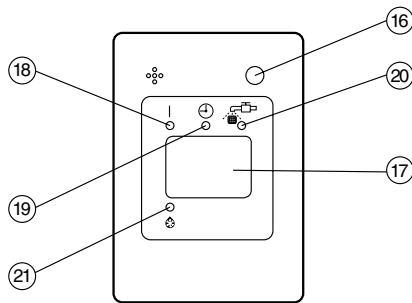

Fig. 1-3

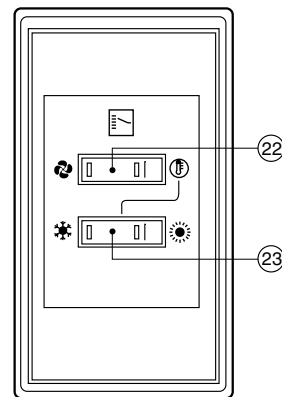

Fig. 2

COOL/HEAT CHANGEOVER  
REMOTE CONTROL SWITCH

- Not necessary to use with some of our product types.

## CONTENTS

ILLUSTRATIONS .....3  
 1. SAFETY CONSIDERATIONS .....4  
 2. NAMES AND FUNCTIONS OF THE OPERATING SECTION .....4  
 3. HANDLING FOR WIRELESS REMOTE CONTROLLER.....5  
 4. OPERATION PROCEDURE .....6  
 5. NOT MALFUNCTION OF THE AIR CONDITIONER .....9  
 6. HOW TO DIAGNOSE TROUBLE SPOTS.....9

### 1. SAFETY CONSIDERATIONS

Please read these "SAFETY CONSIDERATIONS" carefully before installing air conditioning equipment and be sure to install it correctly. After completing the installation, make sure that the unit operates properly during the start-up operation. Please instruct the customer on how to operate the unit and keep it maintained.

Also, inform customers that they should store this operation manual along with the installation manual for future reference. This air conditioner comes under the term "appliances not accessible to the general public".

Meaning of warning, caution and note symbols.

**⚠ WARNING** ..... Indication a potentially hazardous situation which, if not avoided, could result in death or serious injury.

**⚠ CAUTION** ..... Indication a potentially hazardous situation which, if not avoided, may result in minor or moderate injury. It may also be sued to alert against unsafe practices.

**⚠ NOTE**.....Indication situation that may result in equipment or property-damage-only accidents.

**Keep these warning sheets handy so that you can refer to them if needed.**

Also, if this equipment is transferred to a new user, make sure to hand over this operation manual to the new user.

#### ⚠ WARNING

- **It is not good for your health to expose your body to the air flow for a long time.**
- **In order to avoid electric shock, fire or injury, or if you detect any abnormality such as smell of fire, turn off power and call your dealer for instructions.**
- **Ask your dealer for installation of the air conditioner.** Incomplete installation performed by yourself may result in a water leakage, electric shock, and fire.
- **Ask your dealer for improvement, repair, and maintenance.** Incomplete improvement, repair, and maintenance may result in a water leakage, electric shock, and fire.
- **Do not put a finger, a rod or other objects into the air inlet or outlet. As the fan is rotating at high speed, it will cause injury.**
- **Ask your dealer to move and reinstall the air conditioner.** Incomplete installation may result in a water leakage, electric shock, and fire.

- **Do not touch the switch with wet fingers.** Touching a switch with wet fingers can cause electric shock.
- **Do not operate the air conditioner with a wet hand.** Otherwise, you could receive an electric shock.

#### ⚠ CAUTION

- **Do not use the air conditioner for other purposes.** In order to avoid any quality deterioration, do not use the unit for cooling precision instruments, food, plants, animals or works of art.
- **To avoid oxygen deficiency, ventilate the room sufficiently if equipment with burner is used together with the air conditioner.**
- **Do not allow a child to mount on the unit or avoid placing any object on it.** Falling or tumbling may result in injury.
- **Do not let children play on and around the unit.** If they touch the unit carelessly, it may result in injury.
- **Do not place a flower vase and anything containing water.** Water may enter the unit, causing an electric shock or fire.
- **Do not operate the air conditioner when using a room fumigation - type insecticide.** Failure to observe could cause the chemicals to become deposited in the unit, which could endanger the health of those who are hypersensitive to chemicals.
- **Never use flammable spray such as hair spray, lacquer or paint near the unit.** It may cause a fire.

### 2. NAMES AND FUNCTIONS OF THE OPERATING SECTION (Fig. 1-1~3, 2)

1	<b>DISPLAY "▲" "I" (SIGNAL TRANSMISSION)</b> This lights up when a signal is being transmitted.
2	<b>DISPLAY "⊗" "⊙" "⊠" "⊡" "⊢" "⊣" "⊤" (OPERATION MODE)</b> This display shows the current OPERATION MODE. For VRV system, "⊠" is not installed.
3	<b>DISPLAY "TEMP" "OFF" (SET TEMPERATURE)</b> This display shows the set temperature.
4	<b>DISPLAY "hr. ⓪ 3 hr. ⓪ 4" (PROGRAMMED TIME)</b> This display shows PROGRAMMED TIME of the system start or stop.
5	<b>DISPLAY "⊗" "⊙" "⊠" "⊡" (FAN SPEED)</b> This display shows the set fan speed.
6	<b>DISPLAY "TEST" (INSPECTION/ TEST OPERATION)</b> When the INSPECTION/TEST OPERATION BUTTON is pressed, the display shows the system mode is in.
7	<b>ON/OFF BUTTON</b> Press the button and the system will start. Press the button again and the system will stop.

8	<b>FAN SPEED CONTROL BUTTON</b> Press this button to select the fan speed, HIGH, MEDIUM or LOW, of your choice.
9	<b>TEMPERATURE SETTING BUTTON</b> Use this button for SETTING TEMPERATURE. (Operates with the front cover of the remote controller closed.)
10	<b>PROGRAMMING TIMER BUTTON</b> Use this button for programming "START and/or STOP" time. (Operates with the front cover of the remote controller opened.)
11	<b>TIMER MODE START/STOP BUTTON</b> Refer to page 7.
12	<b>TIMER RESERVE/CANCEL BUTTON</b> Refer to page 7.
13	<b>OPERATION MODE SELECTOR BUTTON</b> Press this button to select OPERATION MODE.
14	<b>FILTER SIGN RESET BUTTON</b> Refer to the section of MAINTENANCE in the operation manual attached to the indoor unit.
15	<b>INSPECTION/TEST OPERATION BUTTON</b> This button is pressed for inspection or test operation. Do not use for normal operation.
16	<b>EMERGENCY OPERATION SWITCH</b> This switch is readily used if the remote controller does not work.
17	<b>RECEIVER</b> This receives the signals from the remote controller.
18	<b>OPERATING INDICATOR LAMP (Red)</b> This lamp stays lit while the air conditioner runs. It flashes when the unit is in trouble.
19	<b>TIMER INDICATOR LAMP (Green)</b> This lamp stays lit while the timer is set.
20	<b>AIR FILTER CLEANING TIME INDICATOR LAMP (Red)</b> Lights up when it is time to clean the air filter.
21	<b>DEFROST LAMP (Orange)</b> Lights up when the defrosting operation has started. (For cooling only type this lamp does not turn on.)
22	<b>FAN/AIR CONDITIONING SELECTOR SWITCH</b> Set the switch to "🌀" (FAN) for FAN and "🌡️" (A/C) for HEAT or COOL.
23	<b>COOL/HEAT CHANGEVER SWITCH</b> Set the switch to "❄️" (COOL) for COOL and "☀️" (HEAT) for HEAT.

- NOTE**
- For the sake of explanation, all indications are shown on the display in Fig. 1-1 contrary to actual running situations.
  - Fig. 1-2 shows the remote controller with the front cover opened.
  - Fig. 2 shows this remote controller can be used in conjunction with the one provided with the VRV system.
  - If the air filter cleaning time indicator lamp lights up, clean the air filter as explained in the operation manual provided with the indoor unit. After cleaning and reinstalling the air filter, press the filter sign reset button on the remote controller. The air filter cleaning time indicator lamp on the receiver will go out.
  - The DEFROST lamp will flash when the power is turned on. This is not a malfunction.

### 3. HANDLING FOR WIRELESS REMOTE CONTROLLER

- **Precautions in handling remote controller**
- **Direct the transmitting part of the remote controller to the receiving part of the air conditioner.**  
If something blocks the transmitting and receiving path of the indoor unit and the remote controller as curtains, it will not operate.

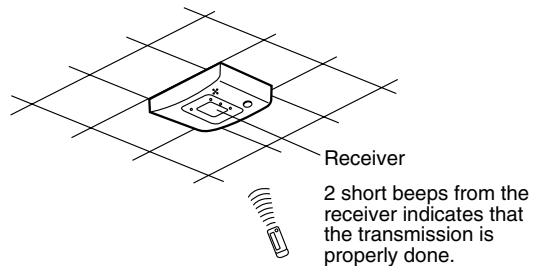

- **Transmitting distance is approximately 23 ft..**
- **Do not drop or get it wet.**  
It may be damaged.
- **Never press the button of the remote controller with a hard, pointed object.**  
The remote controller may be damaged.
- **Installation site**  
It is possible that signals will not be received in rooms that have electronic fluorescent lighting. Please consult with the salesman before buying new fluorescent lights. If the remote controller operated some other electrical apparatus, move that machine away or consult your dealer.

**Placing the remote controller in the remote controller holder**  
Install the remote controller holder to a wall or a pillar with the attached screw. (Make sure it transmits.)



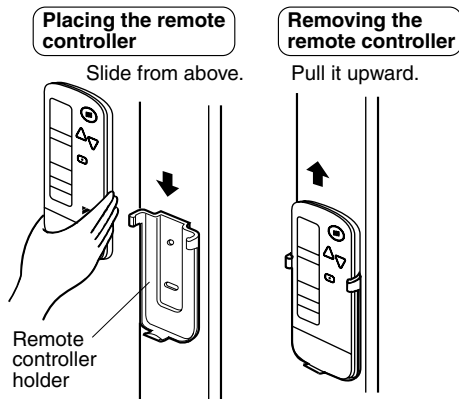

**How to put the dry cell batteries**

- (1) Remove the back cover of the remote controller to the direction pointed by the arrow mark.
- (2) Put the dry cell batteries. Use two LR03<AM4> dry cell batteries. Put the dry cell batteries correctly to fit their (+) and (-).
- (3) Close the back cover as before.

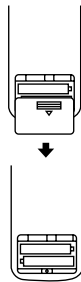

**When to change batteries**

Under normal use, batteries last about 1 year. However, change them whenever the indoor unit doesn't respond or responds slowly to commands, or if the display becomes dark.

**CAUTION**

- Replace all batteries at the same time, do not use new and old batteries intermixed.
- In case the remote controller is not used for a long time take out all batteries in order to prevent liquid leak of the battery.

**IN THE CASE OF CENTRALIZED CONTROL SYSTEM**

If the indoor unit is under centralized control, it is necessary to switch the remote controller's setting. In this case, contact your dealer.

**4. OPERATION PROCEDURE**

- Contact your dealer to confirm your system type.
- To protect the unit, turn on the main power switch 6 hours before operation.
- If the main power supply is turned off during operation, operation will restart automatically after the power turns back on again.

**COOLING, HEATING, AUTOMATIC, FAN, AND PROGRAM DRY OPERATION**

Operate in the following order.

- AUTOMATIC OPERATION can be selected only by Heat pump system or Heat recovery system.

**<<(FOR SYSTEMS WITHOUT COOL/HEAT CHANGEOVER REMOTE CONTROL SWITCH (Fig. 1-1~2 on page 3))>>**

**1 OPERATION MODE SELECTOR**

Press OPERATION MODE SELECTOR button several times and select the OPERATION MODE of your choice as follows.

- COOLING OPERATION ..... “❄️”
- HEATING OPERATION ..... “🔥”
- AUTOMATIC OPERATION ..... “🔄”
  - In this operation mode, COOL/HEAT changeover is automatically conducted.
  - For VRV system, “🔄” is not installed.
- FAN OPERATION ..... “🌀”
- DRY OPERATION ..... “💧”
  - The function of this program is to decrease the humidity in your room with the minimum temperature decrease.
  - The microchip automatically determines TEMPERATURE and FAN SPEED.
  - This system does not go into operation if the room temperature is below 60°F.

**2 ON/OFF**

Press ON/OFF button.

OPERATING INDICATOR lamp lights up or goes off and the system starts or stops OPERATION.

**NOTE**

- Do not turn off power immediately after the unit stops. Then, wait no less than 5 minutes. Water is leaking or there is something else wrong with the unit.

**<<(FOR SYSTEMS WITH COOL/HEAT CHANGEOVER REMOTE CONTROL SWITCH (Fig. 2 on page 3))>>**

**1 OPERATION MODE SELECTOR**

(1) Select OPERATION MODE with the COOL/HEAT CHANGEOVER REMOTE CONTROL SWITCH as follows.

- COOLING OPERATION ..... “❄️”
- HEATING OPERATION ..... “🔥”
- FAN OPERATION ..... “🌀”
- DRY OPERATION ..... “💧”

- See “FOR SYSTEM WITHOUT COOL/HEAT CHANGEOVER REMOTE CONTROL SWITCH” for details on dry operation.

(2) Press **OPERATION MODE SELECTOR** button several times and select “”.  
(This operation is only available during dry operation.)



**Press ON/OFF button.**  
OPERATING INDICATOR lamp lights up or goes off and the system starts or stops OPERATION.

- NOTE**
- Do not turn off power immediately after the unit stops. Then, wait no less than 5 minutes.  
Water is leaking or there is something else wrong with the unit.

**[EXPLANATION OF HEATING OPERATION]**  
**DEFROST OPERATION**

- As the frost on the coil of an outdoor unit increase, heating effect decreases and the system goes into DEFROST OPERATION.
- The fan operation stops and the DEFROST lamp of the indoor unit goes on.
- After 6 to 8 minutes (maximum 10 minutes) of DEFROST OPERATION, the system returns to HEATING OPERATION.

**Heating capacity & Outdoor air temperature**



- Heating capacity drops as outdoor air temperature lowers. If feeling cold, use another heater at the same time as this air conditioner.
- Hot air is circulated to warm the room. It will take some time from when the air conditioner is first started until the entire room becomes warm. The internal fan automatically turns at low speed until the air conditioner reaches a certain temperature on the inside. In this situation, all you can do is wait.
- If hot air accumulates on the ceiling and feet are left feeling cold, it is recommended to use a circulator. For details, contact the place of purchase.

**ADJUSTMENT**



For programming TEMPERATURE and FAN SPEED, follow the procedure shown below.



**Press TEMPERATURE SETTING button and program the setting temperature.**

-  Each time this button is pressed, setting temperature rises 1°F.
-  Each time this button is pressed, setting temperature lowers 1°F.

**In case of automatic operation**

-  Each time this button is pressed, setting temperature shifts to “H” side.
-  Each time this button is pressed, setting temperature shifts to “L” side.

[°F]

	H	•	M	•	L
Setting temperature	77	73	71	70	66

- The setting is impossible for fan operation.

- NOTE**
- The setting temperature range of the remote controller is 60°F to 90°F.



**Press FAN SPEED CONTROL button.**  
High, Medium or Low fan speed can be selected. The microchip may sometimes control the fan speed in order to protect the unit.

**PROGRAM TIMER OPERATION**



- Operate in the following order.
- The timer is operated in the following 2 ways.
    - Programming the stop time (⊕ · ○)  
.... The system stops operating after the set time has elapsed.
    - Programming the start time (⊕ · |)  
.... The system starts operating after the set time has elapsed.
  - The timer can be programmed a maximum of 72 hours.
  - The start and the stop time can be simultaneously programmed.



**Press the TIMER MODE START/STOP button several times and select the mode on the display.**  
The display flashes.  
For setting the timer stop .... “⊕ · ○”  
For setting the timer start .... “⊕ · |”



**Press the PROGRAMMING TIMER button and set the time for stopping or starting the system.**

-  When this button is pressed, the time advances by 1 hour.
-  When this button is pressed, the time goes backward by 1 hour.



**Press the TIMER RESERVE button.**  
The timer setting procedure ends.  
The display changes from flashing light to a constant light.



**Press the TIMER CANCEL button to cancel programming.**  
The display vanishes.

For example.

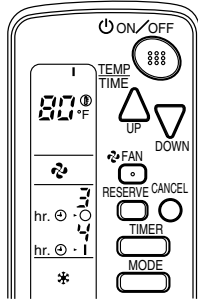

When the timer is programmed to stop the system after 3 hours and start the system after 4 hours, the system will stop after 3 hours and then 1 hour later the system will start.

**NOTE**

- After the timer is programmed, the display shows the remaining time.

**HOW TO SET MASTER REMOTE CONTROLLER (For VRV system)**

- When the system is installed as shown below, it is necessary to designate the master remote controller.

**■ For Heat pump system**

When 1 outdoor unit is connected with several indoor units.

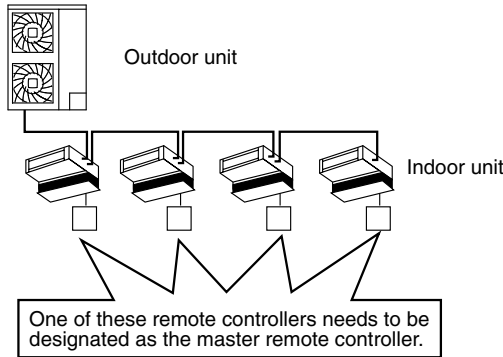

**■ For Heat recovery system**

When 1 BS unit is connected with several indoor units.

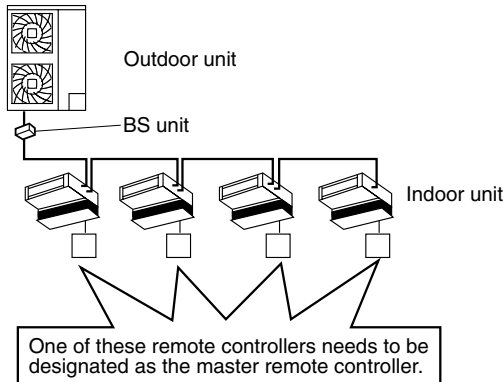

- Only the master remote controller can select HEATING, COOLING or AUTOMATIC OPERATION.

When the indoor unit with master remote controller is set to “COOL”, you can switch over operation mode between “FAN”, “DRY” and “COOL”.

When the indoor unit with master remote controller is set to “HEAT”, you can switch over operation mode between “FAN” and “HEAT”.

When the indoor unit with master remote controller is set to “FAN”, you cannot switch operation mode.

1 long beep ..... When attempting settings than that consented above.

Only with Heat recovery system, you can set the indoor unit to AUTOMATIC. Attempting to do so.

**How to designate the master remote controller**

Operate in the following order.



**Continuously press the OPERATION MODE SELECTOR button for 4 seconds.**

The displays showing “⊕” of all slave indoor unit connected to the same outdoor unit or BS unit flash.



**Press the OPERATION MODE SELECTOR button to the indoor unit that you wish to designate as the master remote controller. Then designation is completed. This indoor unit is designated as the master remote controller and the display showing “⊕” vanishes.**

- To change settings, repeat steps ① and ②.

**EMERGENCY OPERATION**

When the remote controller does not work due to battery failure or the absence there of, use this switch which is located beside the discharge grille on the indoor unit. When the remote controller does not work, but the battery low indicator on it is not lit, contact your dealer.

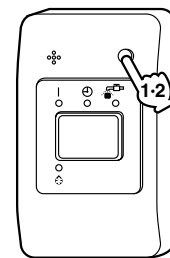

**[START]**

**1 Press the EMERGENCY OPERATION switch.**

The machine runs in the previous mode.

**[STOP]**

**2 Press the EMERGENCY OPERATION switch again.**

**PRECAUTIONS FOR GROUP CONTROL SYSTEM OR 2 REMOTE CONTROLLERS CONTROL SYSTEM**

This system provides 2 other control systems beside individual control (1 remote controller controls 1 indoor unit) system. Confirm the following if your unit is of the following control system type.

- **Group control system**  
1 remote controller controls up to 16 indoor units.  
All indoor units are equally set.
- **2 remote controllers control system**  
2 remote controllers control 1 indoor unit.  
(In case of group control system, 1 group of indoor units)  
The unit follows individual operation.

**NOTE**

- Cannot have 2 remote controllers control system with only wireless remote controllers. (It will be a 2 remote controllers control system having 1 wired and 1 wireless remote controllers.)
- Under 2 remote controllers control system, wireless remote controller cannot control timer operation.
- Only the operating indicator lamp out of 3 other lamps on the indoor unit display functions.
- Contact your dealer in case of changing the combination or setting of group control and 2 remote controllers control systems.

**5. NOT MALFUNCTION OF THE AIR CONDITIONER**

The following symptoms do not indicate air conditioner malfunction.

- **THE SYSTEM DOES NOT OPERATE**
  - **The system does not restart immediately after the ON/OFF button is pressed.**  
If the OPERATING INDICATOR lamp lights, the system is in normal condition. It does not restart immediately because a safety device operates to prevent overload of the system. After 3 minutes, the system will turn on again automatically.
  - **The system does not restart immediately when TEMPERATURE SETTING button is returned to the former position after pushing the button.**  
It does not restart immediately because a safety device operates to prevent overload of the system. After 3 minutes, the system will turn on again automatically.
  - **If the reception beep is rapidly repeated 3 times. (It sounds only 2 times when operating normally.)**  
Control is set to the optional controller for centralized control.
  - **If the DEFROST lamp on the indoor unit's display is lit when heating is started.**  
This indication is to warn against cold air being blown from the unit. There is nothing wrong with the equipment.
- **The unit stops operation from time to time.**
  - **With "U4" "U5" displayed on the remote controller, the unit stops, but it resumes operation in a few minutes.**  
Since electric noises produced from other equipment than the air conditioner interrupt communication between the units, the unit stops operation.  
If these electric noises subside, operation is restarted automatically.
- **COOLING / HEATING changeover is impossible.**
  - **If the indoor unit emits a receiving sound "1 long beep".**  
It is because the indoor unit under the control of operation changeover is set to the mode that cannot be selected.

- **Display Indicates only a part.**
  - **Even if the unit is in operation, the display shows only operational indication. Even if the indication is shown, the indication other than operation disappears after a while.**  
It is because the remote controller is set to multi-system.
- **Display disappears or shows all indication.**
  - **It happens when the button of the remote controller is pressed.**  
It is because the battery is dead.
- **No favorable cooling is achieved.**
  - **The unit is in DRY OPERATION.**  
DRY OPERATION is carried out to perform operation such that the room temperature is not decreased as much as possible.

**6. HOW TO DIAGNOSE TROUBLE SPOTS**

■ **EMERGENCY STOP**  
When the air conditioner stops in emergency, the run lamp on the indoor unit starts blinking. Take the following steps yourself to read the malfunction code that appears on the display. Contact your dealer with this code. It will help pinpoint the cause of the trouble, speeding up the repair.

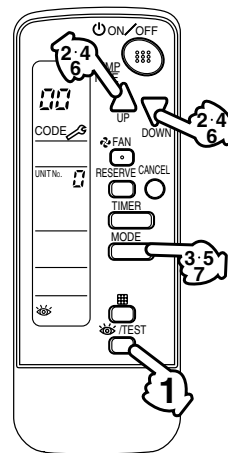

**Press the INSPECTION/TEST OPERATION button to select the inspection mode "I".**

"I" appears on display and blinks. "UNIT No." lights up.



**Press PROGRAMMING TIMER button and change the unit number.**

Press to change the unit number until the indoor unit beeps and perform the following operation according to the number of beeps.

- Number of beeps**
- 3 short beeps..... Perform all steps from ③ to ⑥.
  - 1 short beep..... Perform ③ and ⑥ steps.
  - 1 long beep..... Normal state



**Press OPERATION MODE SELECTOR button.**

“ ” on the left-hand of the malfunction code blinks.



**Press PROGRAMMING TIMER button and change the malfunction code.**

Press until the indoor unit 2 beeps.



**Press OPERATION MODE SELECTOR button.**

“ ” on the right-hand of the malfunction code blinks.



**Press PROGRAMMING TIMER button and change the malfunction code.**

Press until the indoor unit makes 1 long beep.

The malfunction code is fixed when the indoor unit makes 1 long beep.



**Reset of the display**

**Press OPERATION MODE SELECTOR button to get the display back to the normal state.**

**■ IN CASE BESIDES EMERGENCY STOP**

- **The unit does not operate at all.**
  - Check if the receiver is exposed of sunlight or strong light. Keep receiver away from light.
  - Check if there are batteries in the remote controller. Place the batteries.
  - Check if the indoor unit number and wireless remote controller number are equal.

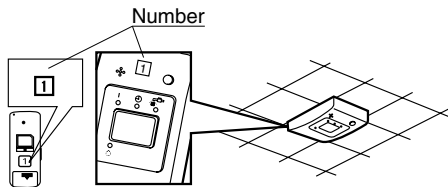

Operate the indoor unit with the remote controller of the same number.  
Signal transmitted from 1 remote controller of a different number cannot be accepted. (If the number is not mentioned, it is considered as “1”.)

**■ The system operates but it does not sufficiently cool or heat.**

- If the set temperature is not proper. (See page 7)
- If the FAN SPEED is set to LOW SPEED. (See page 7)

**Contact the place of purchase in the following case.**

**! WARNING**

When you detect a burning odor, shut OFF power immediately and contact the place of purchase. Using the equipment in anything but proper working condition can result in equipment damage, electric shock or fire.

**[Trouble]**

- **The OPERATING INDICATOR lamp of the indoor unit is flashing and the unit does not work at all.**

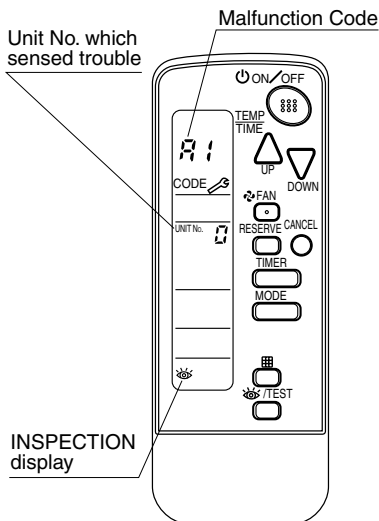

Check the malfunction code (A1 - UF) on the remote controller and contact the place of purchase. (Refer to indoor unit installation manual.)

# 14. Options

## 14.1 Option List

### 14.1.1 Indoor Unit

#### FTX Series

	Option Name	09/12 Class	15 Class	18/24 Class
1	Wired remote controller ★1	BRC944B2 + KRP067A41	BRC944B2 + KRP980B2	BRC944B2
2	Wired remote controller cord (shielded wire)	Length 9.8 ft (3m)	BRCW901A03	
		Length 26.3 ft (8m)	BRCW901A08	
3	Wireless LAN connection adaptor	AZAI6WSCDKB + KRP067A41	AZAI6WSCDKB + KRP980B2	AZAI6WSCDKB
4	Wiring adaptor for timer clock / remote controller ★2 (normal open pulse contact / normal open contact)	KRP413BB1S + KRP067A41	KRP413BB1S + KRP980B2	KRP413BB1S
5	Central remote controller ★3	DCS302C71		
6	Unified ON/OFF controller ★3	DCS301C71		
7	Schedule timer controller ★3	DST301BA61		
8	Interface adaptor for DIII-NET (residential air conditioner)	KRP928BB2S + KRP067A41	KRP928BB2S + KRP980B2	KRP928BB2S
9	Titanium apatite deodorizing filter (without frame) ★4	KAF970A46		
10	Remote controller loss prevention with chain	KKF936A4		KKF910A4

- Notes:** ★1 3 m (BRCW901A03) or 8 m (BRCW901A08) length wired remote controller cord is necessary.  
 ★2 Timer clock and other devices; obtained locally.  
 ★3 An interface adaptor (KRP928BB2S) is also required for each indoor unit.  
 ★4 Standard accessory.

#### FVXS Series

	Option Name	Model Name
1	Wireless LAN connection adaptor	AZAI6WSCDKB
2	Wiring adaptor for timer clock / remote controller ★1 (normal open pulse contact / normal open contact)	KRP413BB1S
3	Central remote controller ★2	DCS302C71
4	Unified ON/OFF controller ★2	DCS301C71
5	Schedule timer controller ★2	DST301BA61
6	Interface adaptor for DIII-NET (residential air conditioner)	KRP928BB2S
7	Titanium apatite deodorizing filter (without frame)	KAF968A42 or KAF968B42
8	Remote controller loss prevention with chain	KKF910A4

- Notes:** ★1 Timer clock and other device ; obtained locally.  
 ★2 An interface adaptor (KRP928BB2S) is also required for each indoor unit.

#### FDMQ Series

	Option Name	Model Name
1	Remote controller (required)	Wired type ★1
		Wireless type
2	Wireless LAN connection adaptor	AZAI6WSCDKA
3	Central remote controller	DCS302C71
4	Unified ON/OFF controller	DCS301C71
5	Schedule timer controller	DST301BA61
6	Remote sensor	KRCS01-4B
7	Wiring adaptor ★2	KRP1C74
8	Installation box for adaptor PCB	KRP4A98
9	Remote controller loss prevention with chain	KKF910A4

- Notes:** ★1 Wiring for wired remote controller should be obtained locally.  
 ★2 Installation box for adaptor PCB (KRP4A98) is necessary.

### 14.1.2 Outdoor Unit

	Option Name	09/12 Class	15/18/24 Class
1	Air direction adjustment grille	KPW937F4	KPW063B4
2	Back protection wire net	KKG067A41	KKG063A42
3	Drain plug ★	KKP937A4	
4	Drain pan heater	FTDBHMS	FTDBHML
		KEH067A41E KEH067A41EA	KEH063A4E KEH063A4EA
5	Snow hood (intake side plate)	KPS067A41	KPS063A41
6	Snow hood (intake rear plate)	KPS067A42	KPS063A44
7	Snow hood (outlet)	KPS067A44	KPS063A47

**Notes:** ★ Standard accessory

## 14.2 <BRC944B2> Wired Remote Controller Installation Manual

### ⚠ CAUTION

1. No switch box or staple is supplied. Prepare them locally.
2. No remote controller cord is supplied. Prepare the optional remote controller cord 4 wire.
3. Be sure to turn off the power to any apparatus connected prior to mounting.
4. Prior to mounting equipment, touch something metallic such as a doorknob to remove static electricity from your body. Never touch the remote controller board or the adapter board.
5. Keep the wiring away from any other power source lines to avoid electric noise (external noise).
6. Select a flat surface, wherever possible, to mount the remote controller. To prevent deformation of the cases, do not overtighten the mounting screws.

#### 1. Securing the remote controller lower case

Insert a bladed screwdriver into the concave (凹) in the remote controller lower case to remove the upper case assembly (two locations).

The remote controller board is located on the upper case. Take care not to scratch the board with the screwdriver.

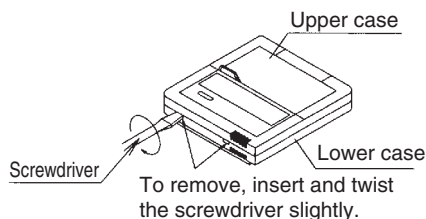

#### (1) Exposed mounting

Secure the remote controller lower case with the two supplied wood screws.



#### (2) Embedded mounting

Secure the remote controller lower case with the two supplied machine screws.

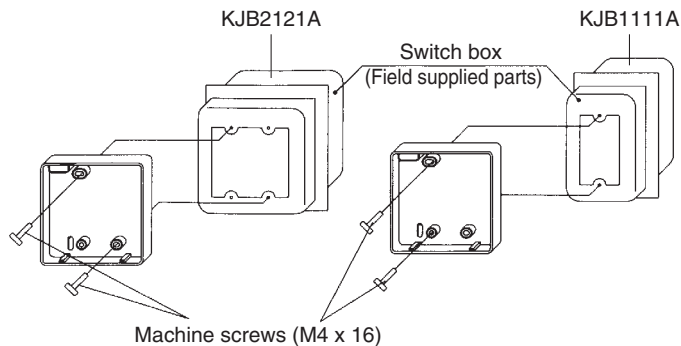

For the field supplied switch box, use optional accessories KJB1111A or KJB2121A.



**2. Securing the remote control adapter**

Remove the upper case of the remote control adapter and secure the lower case assembly.

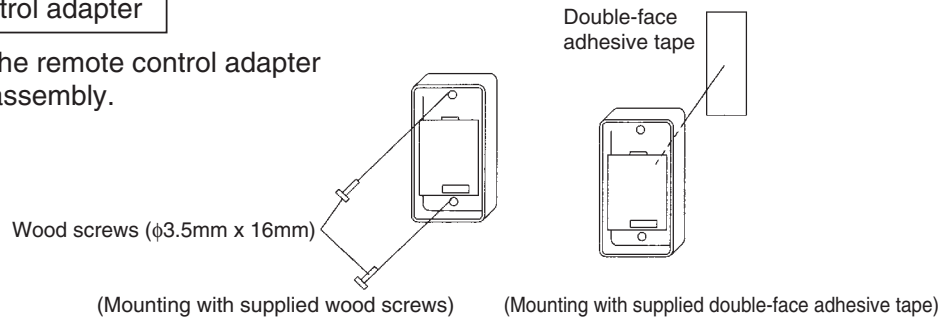

**3. Wiring**

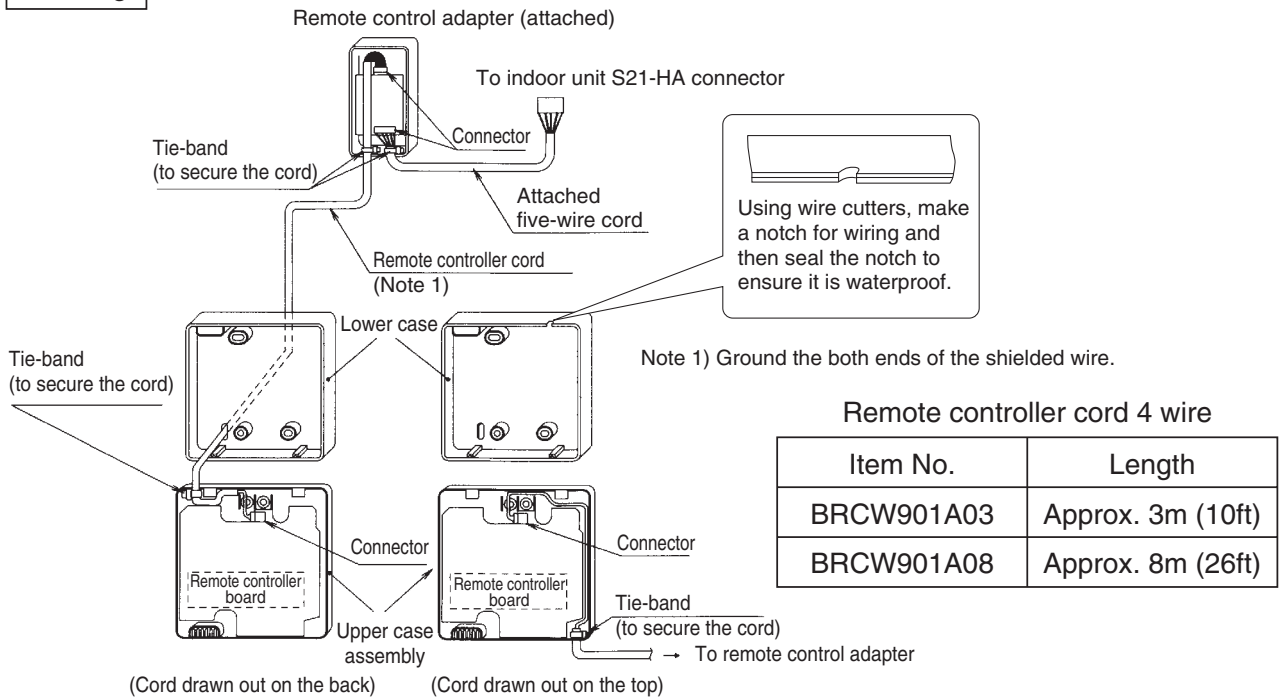

**4. Placing the upper case assembly of the remote controller and the upper case of the remote controller adapter back into their original positions**

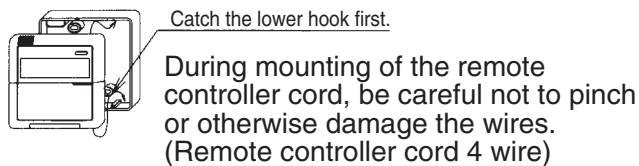

**5. Temperature indication change**

To change from Celsius temperature indication to Fahrenheit one

Press and hold down  at the same time for 5 seconds while the Celsius temperature is indicated.

← See Operation Manual



### 14.3 <BRC944B2> Wired Remote Controller Operation Manual

## Controller Commands and their Corresponding Functions

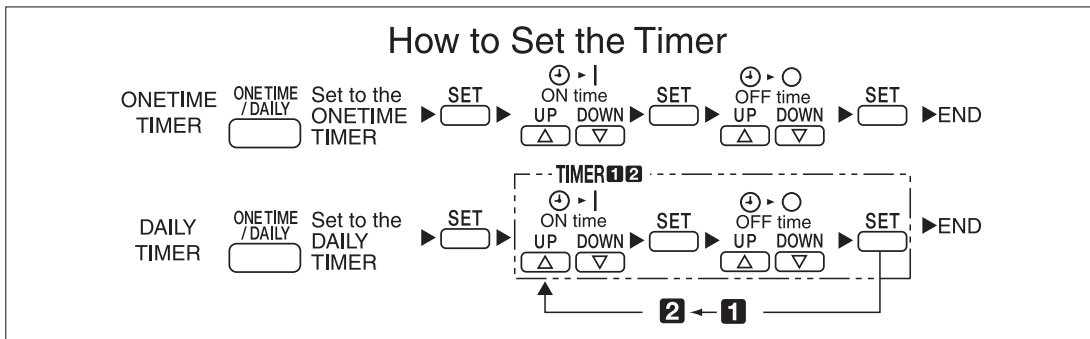
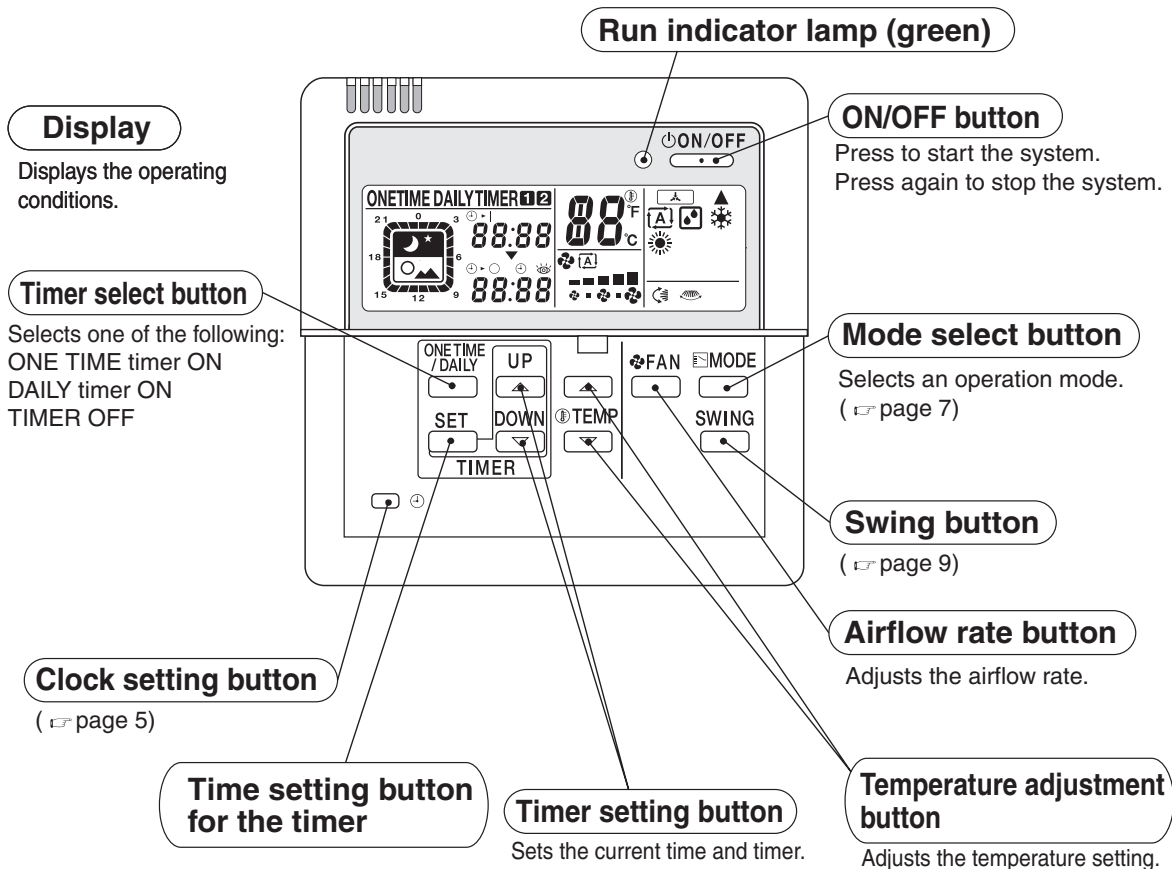

**CAUTION**

- This remote controller cannot be used together with a standard wireless remote controller. Otherwise, what appears on this remote controller's display may fail to correspond to actual operating conditions.

# Preparation before Operation

## ■ Checking the power

If nothing appears on the remote controller's display, turn on the circuit breaker.

## ■ Setting the current time

**1** Press .



The current time starts blinking.  
0:00 lights up.



**2** Press and set the current time.

- Hold the button down to rapidly advance the time.

**3** Press .

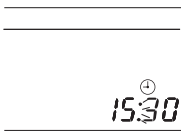

: blinks.  
(This completes the current time setting)

- The clock's accuracy is ±30 seconds per month.

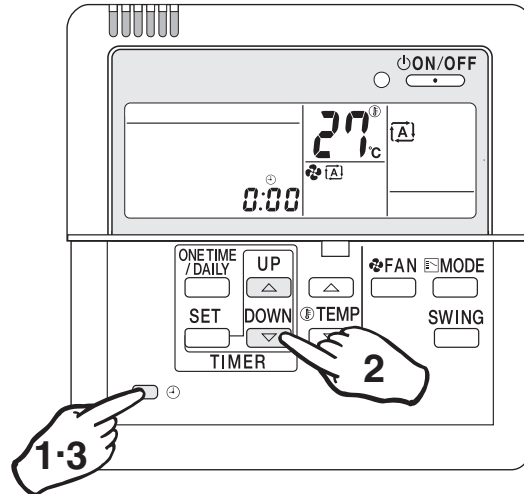

## Notes

### To use the unit efficiently

- Avoid overcooling or overheating. Moderate room temperature setting contributes to power saving.
 

Recommended temperature setting

For cooling ..... 26~28°C (79°F~82°F)

For heating ..... 20~22°C (68°F~72°F)
- Hang a blind or a curtain on the window. This will enhance the cooling/heating effect by intercepting direct sunlight and drafts.
- A clogged air filter reduces the cooling/heating effect and wastes energy. Clean the air filter monthly (every two weeks as required) or so.

### Please take note of the following points

- Electric power is consumed even when the air conditioner is not in operation.
- When the unit is not used for a long period of time such as during off-season, turn off the breaker.

### Operating conditions

- If the operation is continued under any conditions other than the following, the safety device may work to stop the operation. Also, dew may form on the indoor unit and drip from it. (Cooling/DRY)

Cooling	Outdoor temp.	-10 to 46°C (14°F to 115°F)
	Room temp.	18 to 32°C (64°F to 90°F)
	Indoor humidity	Less than 80%
DRY	Outdoor temp.	-10 to 46°C (14°F to 115°F)
	Room temp.	18 to 32°C (64°F to 90°F)
	Indoor humidity	Less than 80%
Heating	Outdoor temp.	-15 to 20°C (5°F to 68°F)
	Room temp.	Less than 27°C

- Operation limit differ according to the model.

# Preparation before Operation

## ■ Setting Temperature Indication change

Temperature indication can be changed between Celsius and Fahrenheit before use.

### To change from Celsius temperature indication to Fahrenheit one

- 1 Press and hold down  at the same time for 5 seconds while the Celsius temperature is indicated.

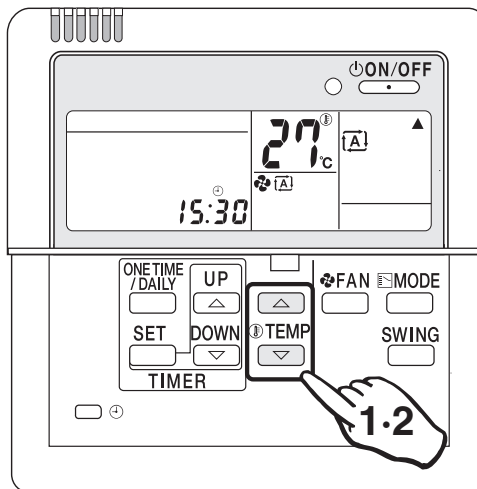

### To change from Fahrenheit temperature indication to Celsius one

- 2 Press and hold down  at the same time for 5 seconds while the Fahrenheit temperature is indicated.



## Notes

### ■ Temperature indication change between Celsius and Fahrenheit on the remote controller

- Change the temperature indication in the modes other than the DRY mode.  
In the DRY mode, temperature indication setting cannot be changed because the temperature is not indicated.
- When the Fahrenheit temperature indication is changed to Celsius one, the temperature value (0.5°C) will be rounded up. Thus, the preset temperature may be changed.

#### Example:

A preset temperature of 65°F (equivalent to 18.5°C) will be changed to 19°C (66°F) by changing the temperature indication. In this case, if you change the Celsius temperature indication again to the Fahrenheit one, the preset temperature is shown not as 65°F but as 66°F (equivalent to 19°C). If the preset temperature is 66°F (equivalent to 19°C) and is changed to the Celsius temperature indication, the indication becomes 19°C (66°F). In this case, no change by the temperature indication change is observed.

- When the temperature indication change is set, the preset temperature is transmitted to the indoor unit so that the reception sound will be heard from the indoor unit.

# Automatic·DRY·Cooling·Heating Operation

Select your desired operation mode.  
Once preset, the system can get restarted in the same operation mode.

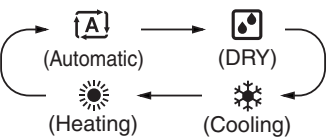
- 1** Press  to select your desired operation mode.
- Each time the button is pressed, the mode changes as follows.
- 

Heat pump model

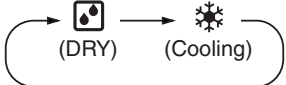

Cooling only model
- The system does not have the FAN mode.

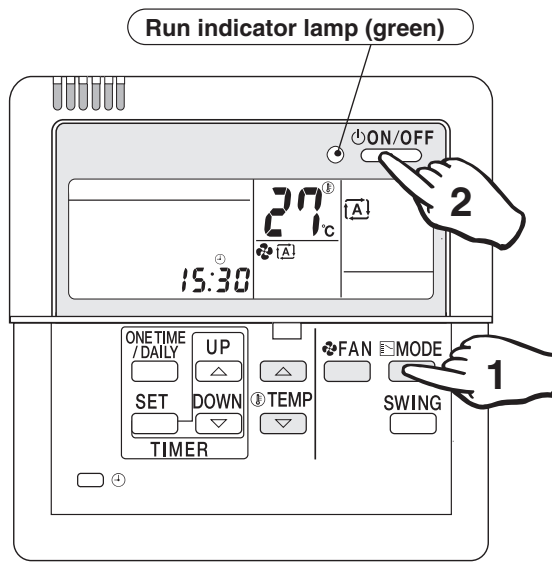

- 2** Press  .  
The run indicator lamp lights up.

**■ To stop the operation:**

- Press  again.  
The run indicator lamp goes out.

**Automatic operation**

- In Automatic, the temperature setting and operation mode (DRY, Cooling or Heating) are automatically selected according to the room temperature and outdoor temperature at the time of starting operation.

**DRY operation**







- In this mode, humidity is removed from the air.

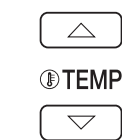

**Note**

- While running in the DRY mode, you may feel cool or warm air from the air outlet. In this case, readjust the airflow direction with the vertical airflow direction louvers. (except Duct Connected type)

■ To adjust the temperature and airflow rate:

Operation mode Setting to be adjusted	Automatic	Cooling	Heating	DRY
 (Temperature)	Temperature is adjustable. Recommended temperature Cooling : 26°C-28°C (79°F~82°F) Heating : 20°C-22°C (68°F~72°F)			Temperature cannot be adjusted.
 (Airflow rate)	Five levels of airflow rate setting from "  " to "  " plus "  " are available. 			Airflow rate cannot be adjusted.

- When the unit runs in the cooling or heating mode at a low airflow rate, the cooling or heating effect may be insufficient.

■ To adjust the airflow direction:

(  page 9)

**Heating operation**

- Since the heating operation is performed by taking the heat from outdoor into the room, the heating capacity decreases as the outdoor temperature lowers. If the room is not heated sufficiently, it is recommended to use other heating appliance at the same time.
- Since the air conditioner heats the whole room by circulating hot air, it takes some time to heat the entire room completely.
- If the outdoor unit gets frosted during heating operation, the heating capacity is decreased. In this case, the unit starts defrosting operation.
- No hot air comes out of the indoor unit during defrosting operation.

# Adjusting Airflow Direction

Adjust the airflow direction for maximum comfort.

## To adjust the Airflow Direction

- 1 Press  during operation.
  - Each time the button is pressed, the airflow direction louvers change their movement.

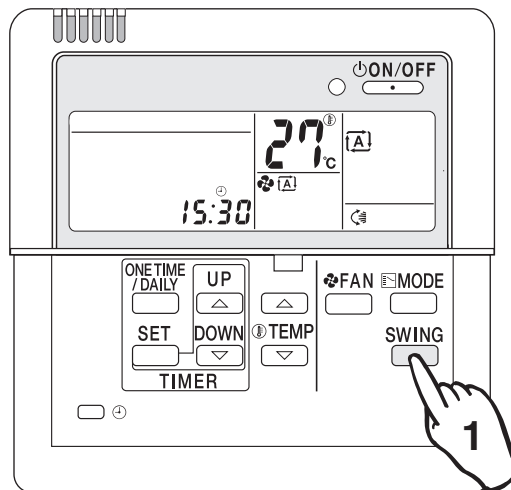

## ■ Wall Mounted Types (without horizontal swing function)

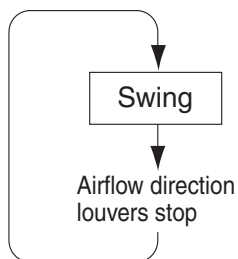

The horizontal airflow direction louvers move up and down.

The louvers stop just when the button is pressed.

### Adjustment of horizontal airflow direction

- The automatic moving range of the horizontal airflow direction louvers varies depending on the operation mode.



#### Notes

- In fixing the horizontal airflow direction, keep the horizontal airflow direction louvers tilted downward in the heating mode, and keep them nearly horizontal level in the cooling or DRY mode. This will enhance the cooling and heating effect.
- On the air conditioners with vertical and horizontal swing function, be sure to adjust the airflow directions using the remote controller. Do not forcibly adjust louvers by hand or a malfunction may occur.

■ **Wall Mounted Type (with horizontal swing function)**

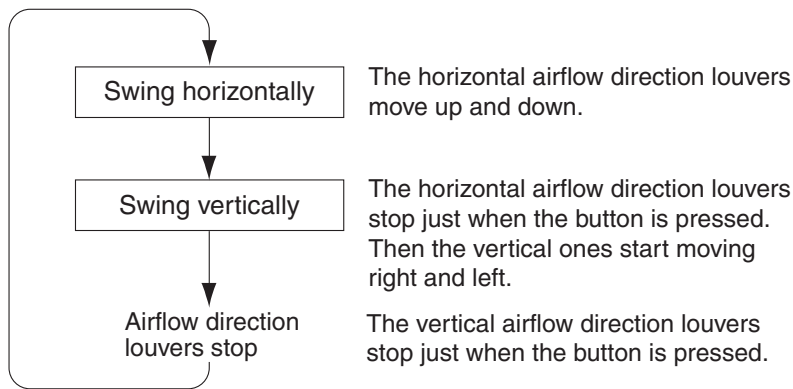

- The vertical and horizontal louvers cannot move at the same time.

■ **Duct Connected Type (without swing function)**

This function cannot be used.



**Note**

- The operating procedure and remote controller display are different depending on the indoor unit being connected. Read **How to Adjust the Airflow Direction** in the air conditioner's Operation Manual.



# Timer Operation

The Timer Operation feature automatically turns off operation when you go to sleep and turns it back on when you wake up.

Use the DAILY Timer mode on weekdays, and the ONE TIME timer mode on weekends.

## ■ To select the ONE TIME timer mode:

1 Press  to select the ONE TIME timer mode.

- Each time the button is pressed, the modes change as follows.

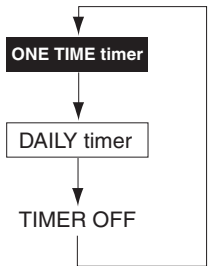

The timer lamp lights up.

## ■ To cancel the timer settings:

1 Press  to clear the timer settings.

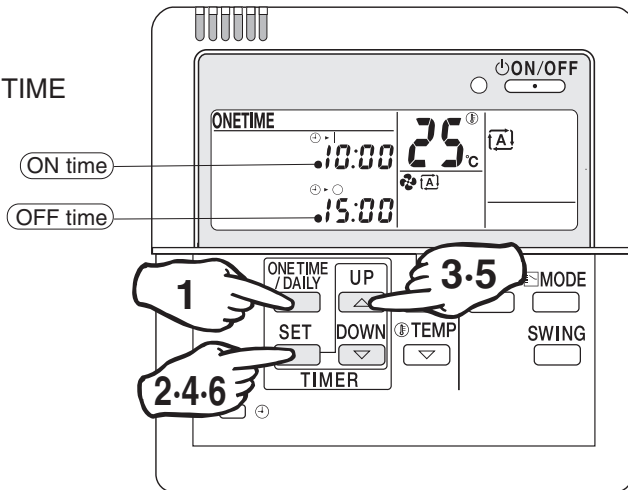
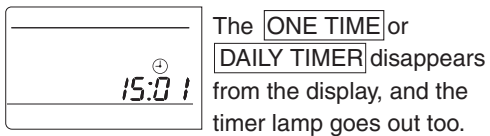

(Timer settings displayed)



### Notes

- Even when the timer has been off, its programmed settings are still in memory.
- If the system has the timer control ON but you start and stop it manually using the ON/OFF button before the designated ON time, the system will restart again at the programmed ON time.

### Precautions in setting the timer

- Before starting the timer operation, make sure the current time is correct. If not, set the clock correctly. (☞ page 5)
- In making time settings, --:-- is displayed to make it easy to disable the timer too.
- If one minute has passed before making any timer setting, the previous timer settings are reintroduced and the timer is on standby. In this case, use the  (time setting) button and make your desired timer settings.

### Timer operation

- When the ON timer is programmed, the system starts one hour (maximum) earlier so that the temperature set by the remote controller is reached just in time.
- When the ONE TIME timer is programmed, the current time is no longer displayed.

### ■ ONE TIME timer

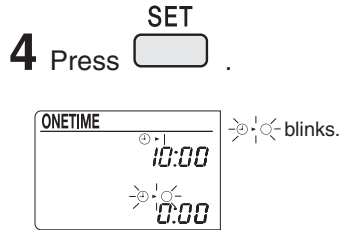
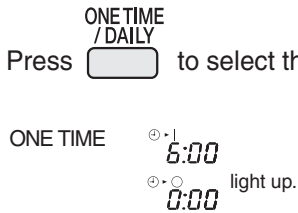

Once the timer has been activated and then deactivated, it is in the OFF mode. The ON or OFF timers can be programmed.

**1** Press  to select the ONE TIME timer. **4** Press .



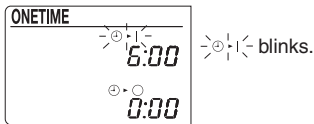

**2** Press .

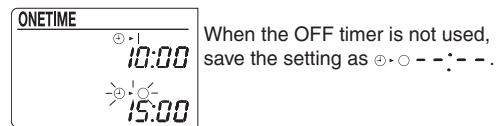

**5** Press   to make the OFF timer setting.



**3** Press   to make the ON timer setting.

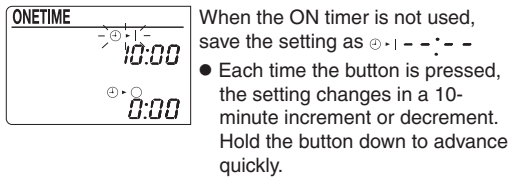

**6** Press  .  
(The ONE TIME timer is now programmed.)

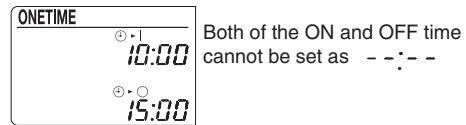

#### Example of display with the ONE TIME timer programmed

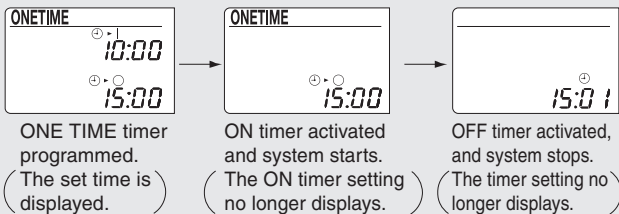

#### Notes

- In the following cases, reset the clock (the time setting is kept in the memory).
  - The circuit breaker has been activated.
  - The power fails.

# Timer Operation

## ■ To select the DAILY timer mode:

1 Press  to select the DAILY timer mode.

- Each time the button is pressed, the modes change as follows.

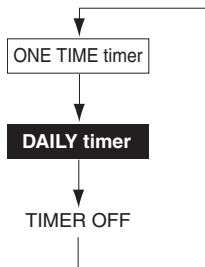

The timer lamp lights up.

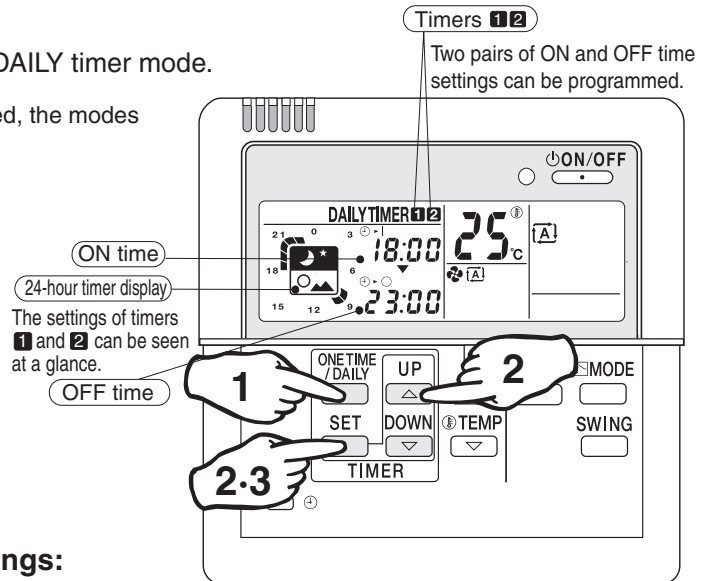

(Timer settings displayed)

## ■ To cancel the timer settings:

1 Press  to clear the timer settings.

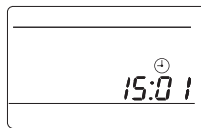

The **ONE TIME** or **DAILY TIMER**, and the timer lamp are no longer displayed.

### Example of display with DAILY timer programmed

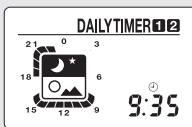

Timers **1** and **2** programmed.

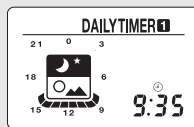

Timer **1** alone programmed.





### Note







- The system starts and stops repeatedly until the DAILY timer is set off. Before you leave home for a long time, set the DAILY timer off.

### ■ DAILY timer

After programming, the system starts and stops each day at the preset times. Two pairs of time settings can be programmed.

(Example: 8:00 ~ 10:00, and 18:00 ~ 23:00)

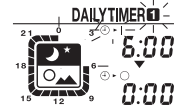
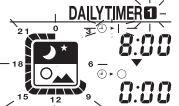
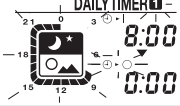
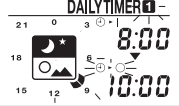
- 1 Press  to select the DAILY timer.  lights up. DAILY timer indication appears.
- 2 Make the ON and OFF time settings. ● Take the steps from ① to ⑧.  
Program example: 8:00 ~ 10:00, and 18:00 ~ 23:00

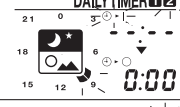
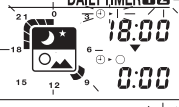
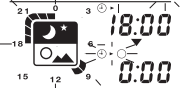
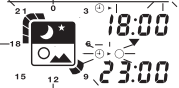
Settings		Procedure	
		Press 	Press  to make the timer setting. 
 1	ON time setting ● When the timer 1 is not used, save the setting as ①-1--:--	① 	② 
	OFF time setting	③ 	④ 
 2	ON time setting ● When the timer 2 is not used, save the setting as ⑤-1--:--	⑤ 	⑥ 
	OFF time setting	⑦ 	⑧ 

- 3 Press . The DAILY timer is now programmed.



#### Note

- If the following appears on the display, the timer must be reprogrammed.

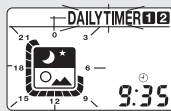

The 24-hour timer display is blinking.

This means that Timers 1 and 2 are programmed for the same time settings. New time settings must be made.



The 24-hour timer display is blinking.

This means that the timer has not been programmed yet.

# Cleaning

## Cleaning the remote controller

- Wipe it clean with soft, dry cloth.  
Do not use any water hotter than 40°C (104°F), or volatile liquids such as benzene, gasoline and thinner, polishing powder, or anything hard such as a scrub brush.

## When the unit is not used for a long time

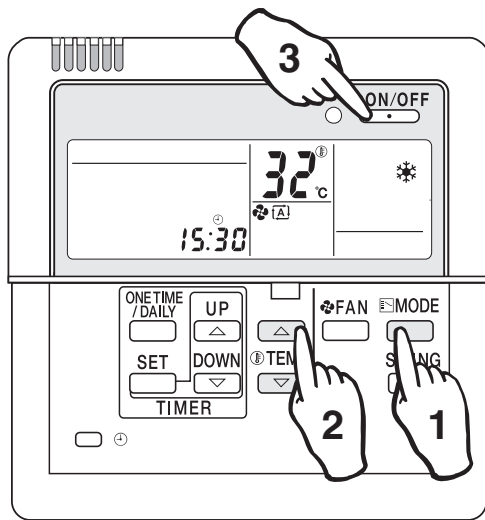

- ① On a sunny day, keep the system running for half a day in the FAN mode to dry it up inside.

### FAN mode

- 1 Press to select the cooling mode.
  - The airflow rate remains the same, and is not adjustable.
  - Run the system when the room temperature is below 28°C (82°F).
- 2 Press to adjust the set temperature to 32°C (90°F).
- 3 Press .
  - ② Finally turn off the circuit breaker dedicated for the room air conditioner.
  - ③ Clean the air filter and place it back into position.

### 14.4 <BRCW901A03/08> Wired Remote Controller Cord

#### Safety Precautions

- Turn OFF the controlled equipment when connecting the equipment.
- Hold the plug of the connector when connecting or disconnecting the connector.

#### Precautions for Use

- This remote controller cable is of thin-profile BRC944-series remote controller units.
- Be sure to ground both ends of the shield wire.
- Install the controlled equipment after reading through the installation manual of the equipment.

#### Complete Parts

##### • Remote Controller Cable

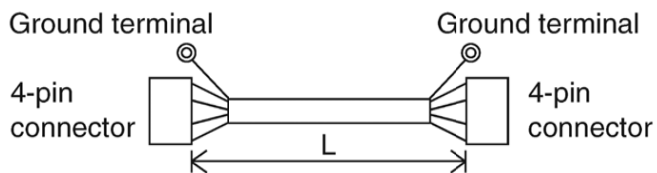

Parts number	L
BRCW901A03	Approx. 3m
BRCW901A08	Approx. 8m

##### • Installation Manual



##### • Packing Case

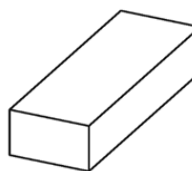

## 14.5 <KRP413BB1S> Wiring Adaptor for Timer Clock/Remote Controller

### Safety Precautions

- Read these safety precautions carefully before installing the unit, and be sure to install the unit properly.
- This manual classifies precautions to the user into the following two categories. These warnings and cautions are for your safety. Follow them.

<b>⚠ WARNING</b>	Faulty installation can result in death or serious injury.
<b>⚠ CAUTION</b>	Faulty installation can result in serious injury, damage to property, or other serious consequences.

- After installation is complete, test the unit to confirm that it is working properly, and instruct the owner its proper use.

### ⚠ WARNING

- Installation should be left to the dealer from whom you purchased the unit, or another qualified professionals.
- Install the unit securely according to the installation manual. Faulty installation may lead to electric shock or fire.
- Be sure to use the supplied or specified parts. Using other parts may lead to electric shock or fire.
- Install the unit securely in a location that will support its weight. If installed in a poor location or improperly installed, the unit may not work as intended.
- For electrical work, follow local electric standards and the installation manual. Faulty installation may lead to fire or electric shock.
- Do not bundle the power cord, or attempt to extend it by splicing it with another cord or by using an extension cord. Do not place any other load on the power circuit used for the unit. Improper wiring may lead to electric shock, heat generation or fire.
- Use dedicated wiring for all electrical connections, and be sure to arrange the wiring so that force applied to the wiring will not damage the terminals. Poor wiring or installation may cause electric shock, heat generation or fire.

### ⚠ CAUTION

- Before installation, unplug the air conditioner to ensure safety. Failure to do so may cause electric shock.
- Static electricity may damage electric components. Before connecting cables and communication lines, and operating the switches, be sure to discharge any electrical charge from your body (by, for example, touching the earth line)
- Do not install the unit in a location where it may be exposed to flammable gases. If gas leaks and build up around the unit, it may catch fire.
- Do not place the wiring close to the power cord, inter-unit cable, or pipes which generate noise. Treat the wiring with care.

### 1. Functions and Features

- On/Off setting
- Switching between Instantaneous Contact/Normal Contact
- Connection with fan coil remote controller
- Automatic reset after power failure
- Output of normal operation signals/malfunction signals

### 2. Field Wiring

For interconnecting wiring, use Daikin KDC100A12 cable (not supplied) or other similar cable. Use a vinyl-covered wire or cable with four conductors each with a thickness of 0.2 to 1.25 mm<sup>2</sup>.

#### ■ Optional cable KDC100A12 (without connectors)

Specifications: 0.2 mm<sup>2</sup> × 4 core (sheathed)  
 Outer diameter: φ5.3  
 Length: 100 m  
 Colour: Grey

Note : Keep any wiring for the control unit away from the power cord to prevent electrical noise.

## Installation ①

### 1 Installation diagram

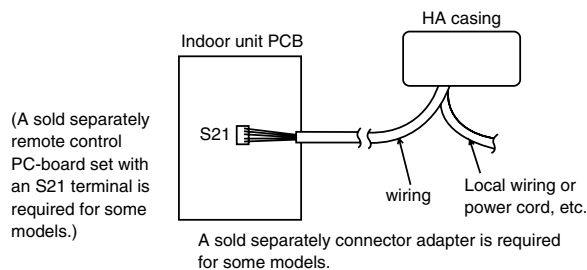

### 2 Components

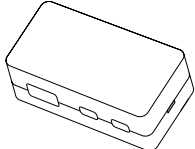
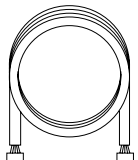
① HA casing ASSY (Remote Control PCB is attached in the HA casing.) 	② Wiring (approx. 0.8 m) (Cannot be made longer.) 
③ Accessories Binding band (6 pcs.) • Screws for attaching to the wall (3 pcs.)	
④ Installation manual	

## Installation ②

### Attaching HA Case ASSY

- Use the 3 supplied screws to attach the HA casing ASSY.

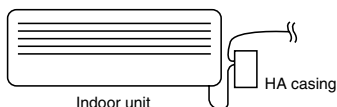

Install the HA casing ASSY as close to the indoor unit as possible.

#### ① Removal of upper HA casing

- (1) Insert a flat-blade screwdriver into the groove between the upper and lower HA casings.

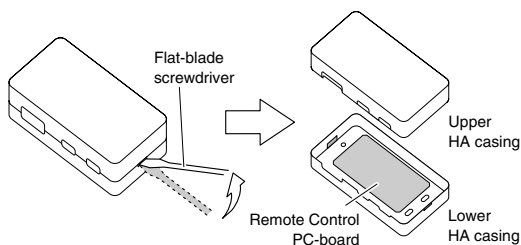

- (2) Lift the handle of the screwdriver upward.

- ② Mount and secure the lower HA casing directly on the wall with the provided screws inserted into the screw holes (a round hole and two ellipse holes) of the casing.

**NOTE** Mount the HA casing in a direction where the wiring through-holes will be hidden in order to prevent infants from putting their fingers into the HA casing and the LED light on the internal PC-board from leaking outside.

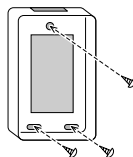

- ③ After connecting the cables (refer to the following sections), replace the case front. Be careful not to damage the wiring in the case.

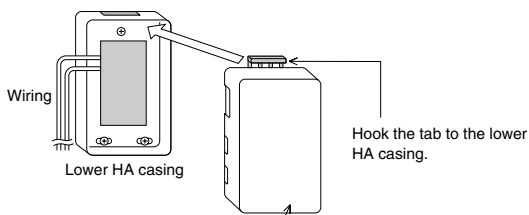

Press the lower part of the upper HA casing and press fit it onto the lower HA casing.  
Press the upper HA casing precisely until a clicking sound is heard.

## Wiring ①

### 1. Wiring

- ① Connect one end of the wiring to connector S21 of the PCB in the indoor unit.
- ② Connect the other end of the wiring to connector S6 of the Remote Control PCB.
- ③ Connect field wiring according to the functions assigned to each connection terminal of the Remote Control PCB.
- ④ Secure all wires.

#### 1 Securing wires in the HA casing ASSY

##### ① Connection of wiring

Connect the wiring to the connector terminals.

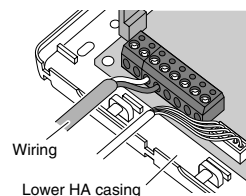

##### ② Fixation of wiring

- (1) Insert the provided binding band under the pillar of the HA casing and secure the covers of the wiring with the binding band.

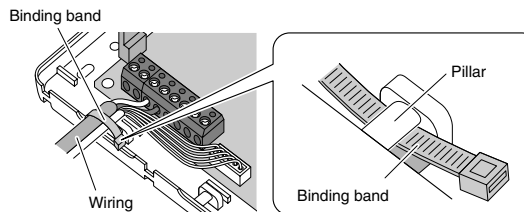

- (2) Insert the second binding band into the groove on the side of the HA casing and fix the wiring securely so that the wiring will not be disconnected.

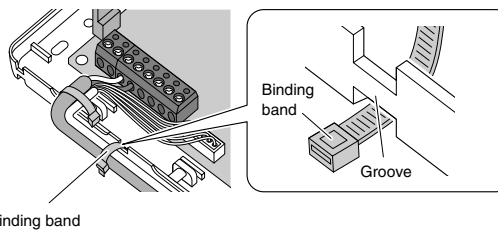

#### A large number of wires

Make a slit with an appropriate tool, such as a cutter knife, on the thin part of the upper HA casing along the frame. Then cut the part with an appropriate tool, such as a pair of nippers.

(NOTE) Cut off only the thin part required for wiring.

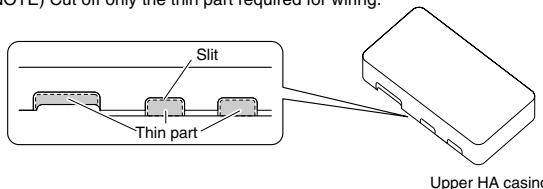

#### 2 Securing wires in the indoor unit

- The method for securing wire varies depending on the model of the air conditioner. See your air conditioner installation manual for details.



## Wiring ②

### 2. Automatic Reset After Power Failure

- This PCB stores the following data in the event of a power failure (the storage period is limitless).
    - ① On/Off (see Note 1)
    - ② Operation modes (see Note 2)
    - ③ Temperature setting
    - ④ Air flow rate
    - ⑤ On/Off status of remote controller
- (Note 1 When SW1-2 is in Off mode, the unit will not be activated.)  
 (Note 2 The following settings apply to the models below.)

Mode before the power outage	COOLING	HEATING
Room air conditioner		
Models with Humid heating and Reheating dehumidifying functions.	DRY COOLING	HUMID HEATING
Models with Reheating dehumidifying function.		HEATING

(Note 3 Not all settings will be saved (e.g., humidity or swing settings will not be saved).)  
 (Note 4 Since a stop due to a momentary power failure cannot be detected, automatic reset may not be possible.)

### 3. Monitor Signal Output (normal operation and malfunction)

- Maximum length of the wiring is 100 m. No external power supply is required.

#### 1 Monitor signal output for LED

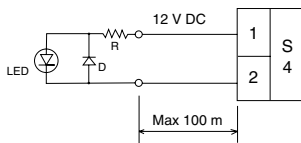

#### Locally procured parts

Item	Manufacturer	Type
LED	Rohm	SLR-342
D	Rohm	1SS133
R		510 ohm 1/4W

#### 2 Monitor signal output (normal operation and malfunction) using external relay contacts

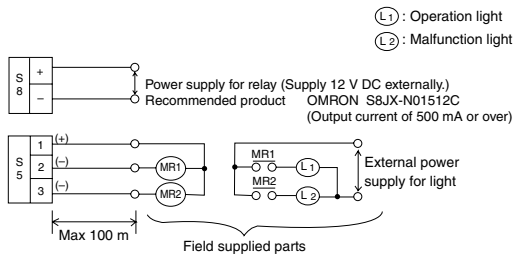

#### Field procured parts (Recommended external relay contacts)

Manufacturer	Type	Coil rated voltage	Coil resistance
Omron	MY relay	12 V DC	160 ohm ± 10%

### 4. Connection with Remote Controller

Example connections with three kinds of remote controllers are shown below. Note: These connections cannot be used in combination.

#### 1 Remote control with switch (field supply)

- Set SW1-1 to Off and select Operation Mode 1.



##### <Instantaneous Contact>

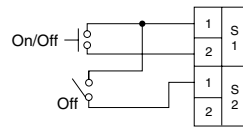

- The remote controller most recently used (local or air conditioner) takes precedence.
- Use a remote controller with a pulse width of 100 msec or more.

##### <Normal Contact>

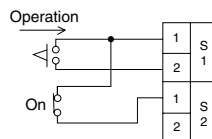

- Power On/Off cannot be controlled from the unit's remote controller. (Three beeps for signal reception will be heard continuously when the wireless remote controller is operated.)
- When power is restored after a power failure in this mode, On or Off is determined according to the current settings of the remote controller.

#### 2 Fan coil remote controller

- Set SW1-1 to On and select Operation Mode 2.
- Most settings (power On/Off, air flow rate, mode change) cannot be made using the air conditioner's remote controller.
- When power is restored after a power failure in this mode, On or Off is determined according to the current settings of the remote controller.
- When the Cooling/Heating mode is changed, use the air conditioner's remote controller to adjust the temperature.

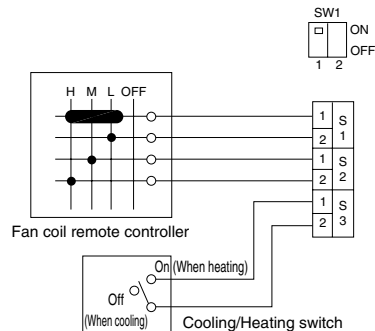

## Test Operation and Confirmation

### 1. When the System is Not Working

- Is the air conditioner working properly?
- Are the connectors of the wiring properly connected?
- Are the remote controller and field wiring properly connected?
- Are all switch settings correct?
- If there is nothing apparently wrong, conduct a diagnostic check using the following procedure.

**■ Diagnostic check**

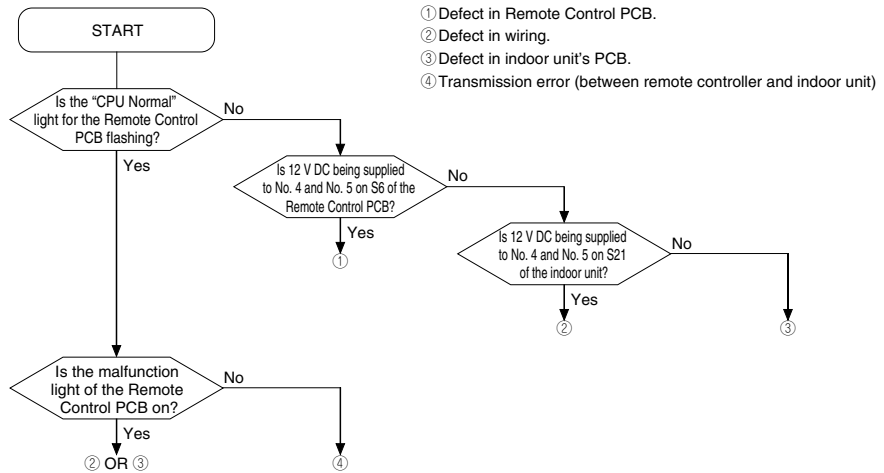

### 2. Switch Settings and Connection Terminals

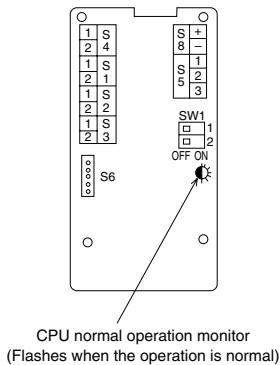

SW1-1	Selecting the operation mode	OFF	Operation mode 1 (Used with the exception of fan coil remote controller settings)	
		ON	Operation mode 2 (Used with fan coil remote controller settings)	
SW1-2	Selecting On/Off when power is restored after a power failure	OFF	Always Off	
		ON	Off if operation was in Off mode before power failure; On if operation was in On mode before power failure	
S1	SW1-1: OFF (Operation mode 1)	S1 (1) - S2 (1)	Instantaneous contact	Normal contact
		S1 (1) - S1 (2)	OPEN	CLOSE
S2	SW1-1: ON (Operation mode 2)	S1 (1) - S1 (2)	Pulse input	OPEN, Not activated
		S2 (2), S3	On/Off switching	CLOSE, Activated
S3	SW1-1: ON (Operation mode 2)	S2 (2), S3	Not used	
		S1, S2 OPEN	Not activated	
S4	(1) - (2)	S1 (1) - S1 (2) CLOSE	On, airflow: L tap	
		S1 (1) - S2 (1) CLOSE	On, airflow: M tap	
S5	(1) - (3)	S1 (1) - S2 (2) CLOSE	On, airflow: H tap	
		S3 (With the remote controller only)	OPEN	Cooling
S6 connector	Connect with connector S21 on the PCB of the indoor unit	CLOSE	Heating	
S4	(1) - (2)	Voltage on (12 V DC), normal operation light output		
S5	(1) - (2)	Normal operation light output (power for light required)		
S5	(1) - (3)	Malfunction light output (power for light required)		
S6 connector	Connect with connector S21 on the PCB of the indoor unit			
S8	(+) - (-)	Relay 12 V DC power supply terminal (Field supplied parts)		

## 14.6 <KRP928BB2S> Interface Adaptor for DIII-NET

### Safety Precautions

- Read these Safety Precautions carefully to ensure correct installation. This manual classifies precautions into WARNING and CAUTION.

**WARNING** : Failure to follow WARNING is very likely to result in such grave consequences as death or serious injury.

**CAUTION** : Failure to follow CAUTION may result in serious injury or property damage, and in certain circumstances, may result in a grave consequence.

Be sure to follow all the precautions below ; they are all important for ensuring safety.

#### WARNING

- Installation should be left to the dealer or another qualified professional.**  
Improper installation by yourself may cause malfunction, electrical shock, or fire.
- Install the set according to the instructions given in this manual.**  
Incomplete or improper installation may cause malfunction, electrical shock, or fire.
- Be sure to use the standard attachments or the genuine parts.**  
Use of other parts may cause malfunction, electrical shock, or fire.
- Disconnect power to the connected equipment before starting installation.**  
Failure to do so may cause malfunction, electrical shock, or fire.
- A ground fault circuit interrupter / an earth leakage circuit breaker should be installed.**  
If the breaker is not installed, electrical shock may occur.

#### CAUTION

- Do not install the set in a location where there is danger of exposure to inflammable gas.**  
Gas accumulated around the unit at the worst may cause fire.
  - To prevent damage due to electrostatic discharge, touch your hand to a nearby metal object (doorknob, aluminum sash, etc.) to discharge static electricity from your body before touching this kit.**  
Static electricity can damage this kit.
  - Lay this cable separately from other power cables to avoid external electrical noises.**
- After installation is complete, test the operation of the PCB set to check for problems, and explain how to use the set to the end-user.

### 1.Overview, Features and Compatible Models

This kit is the interface required when connecting the central controller and a Room Air Conditioner. Use of the central controller makes it possible to perform the following monitoring and operations. It is compatible with room air conditioners which have an HA connector S21.

- Run / stop for the central controller and wired remote controller, operating mode selection, and temperature can be set.
- The operating status, any errors, and the content of those errors can be monitored from the central controller and wired remote controller.
- Run / stop for the central controller and wireless remote controller, operating mode selection, and the temperature setting can be limited by the central controller.
- Zone control can be performed from the central controller.
- The unit can remember the operating status of the air conditioner before a power outage and then start operating in the same status when the power comes back on.
- Card keys, operating control panels, and other constant / instantaneous connection-compatible equipment can be connected.
- The Operating / error signals can be read.
- The indoor temperature can be monitored from the iTM / ITC.

#### Precaution

- When reading the Operating / error signals, a separate external power source (12 V DC) is needed.
- A separate timer power source (16 V DC) is needed when using the schedule timer independently, and not in conjunction with other central controllers.
- The range of temperatures that can be set from the central controller is 18°C to 32°C in cooling and 14°C to 28°C in heating.
- Fan operation cannot be selected from the central controller or wired remote controller.
- Group control (i.e., control of multiple indoor units with a single remote controller) is not available.
- Monitoring is not available of the thermo status, compressor operating status, indoor fan operating status, electric heater, or humidifier operating status.
- Forced thermo off, filter sign display and reset, fan direction and speed settings, air conditioning fee management, energy savings instructions, low-noise instructions, and demand instructions cannot be made.
- Since a stop due to a momentary power failure cannot be detected, automatic operating start may not be possible.

### 2.Component Parts

This kit includes the following components. Check to ensure that none of these are missing.

Parts	Q'ty	Parts	Q'ty
Kit assy PCB is in the housing.	1	Connection harness (about 1.6m)	1
		Mounting screws	3
		Binding band	6
		Installation manual	2

### 3.Names of Parts and Electric Wiring

#### <Wiring procedure>

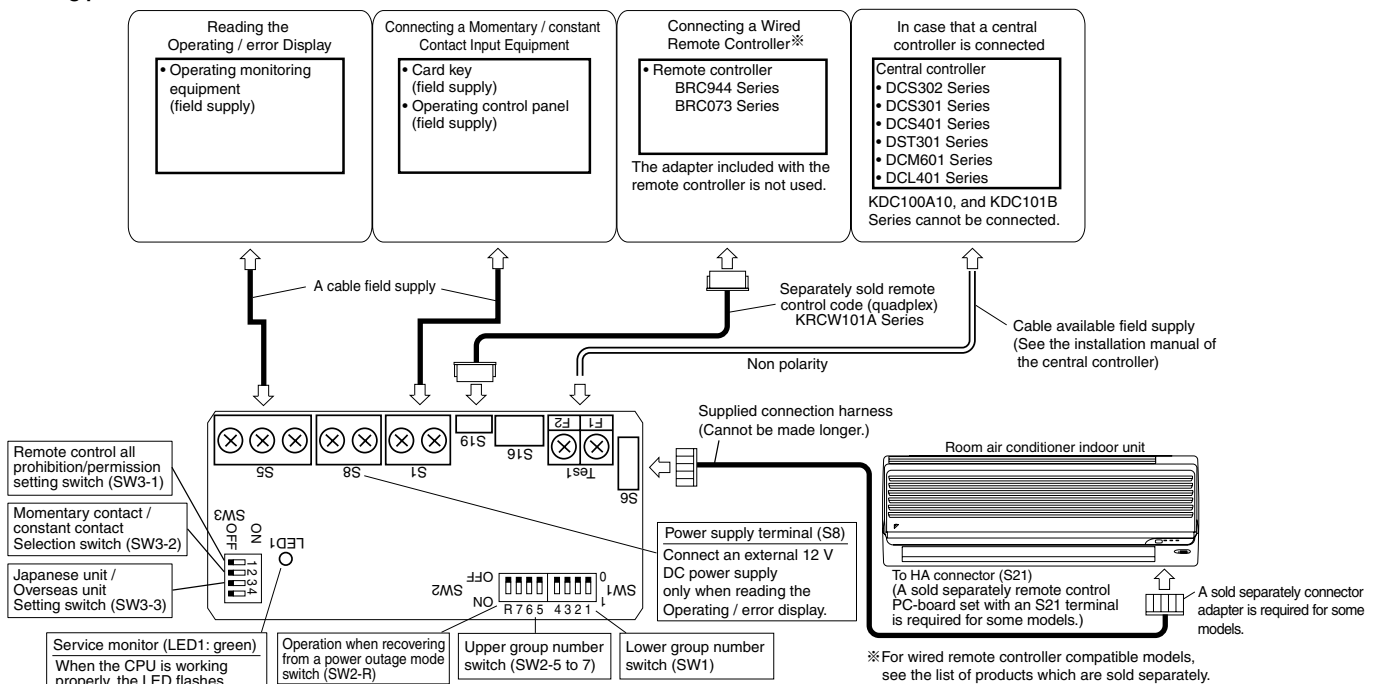

### 4. Switch Settings

**NOTE** Turn the power on after all the switches have been set. Settings made while the power is on are invalid.

Open the Kit's case and set the switches on the circuit board.

(1) For Overseas / Japanese unit setting (SW3-3)  
Room air conditioners, different methods are used for setting the temperature in automatic mode, so this switch needs to be set.

Destination	SW3-3 setting	What Happens
Japan	OFF (Factory setting)	• "Automatic" operation is not available from the central controller. When using "automatic" operation using the wireless remote controller, the central controller displays automatic cooling (heating) and 25°C. Even if the temperature is changed, it will return to 25°C after a while.
Overseas	ON	• "Automatic" operation is available from the central controller.

(2) Group number settings (SW1 and SW2-5 to SW2-7)  
Set these when using the central controller. (Set to the side.) Do not set more than one unit to the same number.  
Use SW2-R for (3) Settings when recovering from a power outage.

However, these settings do not need to be made when using the schedule timer independently.  
(The settings are needed when used in conjunction with another DCS Series central controller.)  
In this case, the schedule timer performs an auto address after the power is turned on, so new group numbers are automatically set. Settings made using the switches will be overwritten.

Group NO. Settings table (Enlarged section SW1 and SW2 in "3. Names of Parts and Electrical Wiring")

Group NO. Upper settings SW2		Group NO. Lower settings SW1									
1		5		00		04		08		12	
2		6		01		05		09		13	
3		7		02		06		10		14	
4		8		03		07		11		15	

: Use with power failure recovery settings    Set to the side : ON : OFF

NOTE also that a separate timer power source is needed when using the schedule timer independently.  
Power source specs: 16 V DC, +10%, -15%, 200mA.

(3) Settings when recovering from a power outage (SW2-R)  
This selects whether to restart operation when the power comes back on after a power outage occurred during operation. This setting is given priority in cases where the indoor unit has an auto start ON / OFF jumper. Note also that regardless of whether switch SW2-R is on or off, the operating mode (NOTE), set temperature, fan direction and speed settings, and remote control prohibition status are stored.

SW2-R setting	What Happens
OFF (Factory setting)	Stops after recovering from a power outage
ON	Stops if the unit was stopped before the power outage and runs if it was running.

(NOTE) The following settings apply to the models below.

Mode before power outage	Room air conditioner	COOLING	HEATING
Models with humid heating and dehumidifying functions.	Models with humid heating and dehumidifying functions.	DRY COOLING	HUMID HEATING
			HEATING
Models with dehumidifying function.	Models with dehumidifying function.		HEATING

(4) Contact input function settings (SW3-1 to SW3-2)  
When using contact input (S1), choose one of the following functions.

S1 operating mode	SW3-1 setting	SW3-2 setting	What Happens	Control mode
Instantaneous contact input (factory setting)	OFF	OFF	The operating status of the air conditioner is reversed by an instantaneous input of 100 msec or more.	Last command priority
Constant contact input	OFF	ON	Contact - Open to close: air condition runs. Close to open: air conditioner is stopped (NOTE 1).	ON / OFF control is rejected (operate / stop / timer prohibition) (NOTE 2).
Remote control all prohibition/permission input	ON	Invalid	Contact - Open to close: air condition stops. Close to open: no change in operating status.	All remote controller actions are prohibited when the contact is closed. (NOTE 3)

NOTE1: Since central controller uses last command priority, the contact status and operating status of the air conditioner might not match sometimes.  
Example: If the unit is run from the central controller while the air conditioner is stopped with an open contact, the contact will be open and the unit will be running.  
NOTE2: Operating mode and fan direction and speed settings can be changed.  
NOTE3: If the contact is closed while the ON timer is set, as the power ON timer function is still operating, the operation starts at the time specified by the timer. To prevent operation of the power ON timer, use of the (KRP413BB1S) remote control PC-board set is recommended. However, note that it cannot be used in tandem with the central controller.  
If this product is connected to an air conditioner manufactured in or after 2011, when the contact is closed, the power ON timer may be cancelled depending on the combination with the model.

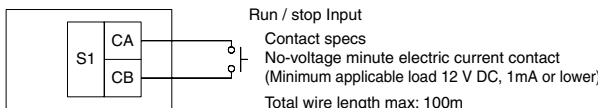

### 5. Control Codes

When using a central remote controller, the operating codes can be used to limit operation from wireless remote controllers. Three beeps for signal reception will be heard continuously when the wireless remote controller is operated while in central control.  
○ : permitted; × : prohibited

S1 operating mode	Control mode	Control code	Operations from the remote controller					
			"Run" control from the central controller			"Stop" control from the central controller		
Instantaneous contact mode	ON / OFF control is rejected	0,1,3	×	×	○	×	×	○
	Only OFF control is accepted	2, 12-19	×	○	×	×	×	×
	Central priority	4	○	○	○	×	×	×
	Last command priority	5	○	○	○	×	×	×
	Timer operation is accepted by remote controller	6,7	○	○	○	○	○	○
		8	○*	○*	○*	×	×	×
Constant contact mode		9	○*	○*	○*	×	×	×
		2,10-19	×	×	×	×	×	×
		0,1,3,5-7	×	×	×	×	×	×
		4	×	×	×	×	×	×
		8	×	×	×	×	×	×
All remote controller actions are prohibited		9	×	×	×	×	×	

\*Only during timer operation  
The remote controller permission / prohibition settings using the iTM / iTC are as follows.  
○ : permitted; × : prohibited

S1 pin operating mode	iTM / iTC settings			Operations from the remote controller			
	Start / stop	Change operating mode	Change set temperature	Run / timer	Stop	Operating mode temperature	Fan direction and fan speed
Instantaneous contact mode	ON / OFF control is permitted	permitted	permitted/prohibited	×	×	○	
	Constant contact mode	prohibited	permitted/prohibited	×	×	×	
Instantaneous contact mode	Only OFF control is accepted	permitted	permitted	×	×	○	
		prohibited	permitted/prohibited	×	○	×	
Constant contact mode	Last command priority	permitted	permitted	×	×	○	
		prohibited	permitted/prohibited	×	×	×	
Instantaneous contact mode	Constant contact mode	permitted	permitted/prohibited	×	×	×	
		prohibited	permitted/prohibited	×	×	×	
All remote controller actions are prohibited	Does not affect settings			×	×	×	×

### 6. Read Operating / Error Display Signal

The Operating / error signals can be read from the contact output (S5).  
Output specs  
M1: Turn MR 1 ON when the air conditioner is running.  
M2: Turn MR 2 when a communication error has occurred between the KRP928BB2S and the air conditioner, or MR 1 is ON and the unit has stopped after an error.  
MR 2 is not turned ON during a warning.

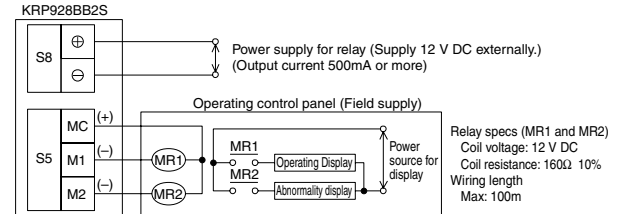

### 7. Combining Equipment

The central controller can be combined with the following devices.

	Central Remote Controller	ON / OFF controller	Schedule timer	D-BIPS	Contact input	Wired Remote Controller	Wireless Remote Controller
Central Remote Controller	○	○	○	○	○	○	○
ON / OFF controller	○	○	○	○	○	○	○
Schedule timer	○	○	×	×	○	○	○
D-BIPS	○	○	×	×	○	○	○
Contact input	○	○	○	○	×	○	○
Wired Remote Controller	○	○	○	○	○	×	×
Wireless Remote Controller	○	○	○	○	○	○	×

## Connection to Remote Control PC-board

### 1. Removal of upper HA casing

① Insert a flat-blade screwdriver into the groove between the upper and lower casings.

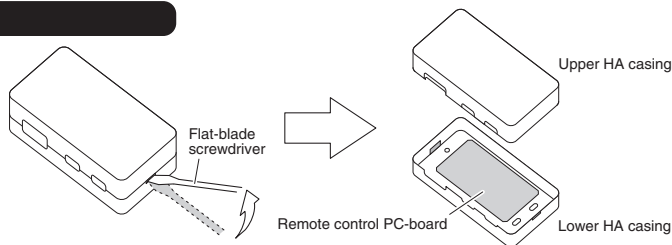

② Lift the handle of the screwdriver upward.

### 2. Securing of lower HA casing

Mount and secure the lower HA casing directly on the wall with the provided screws inserted into the screw holes (a round hole and two ellipse holes) of the casing.

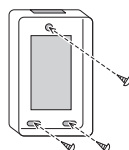

**NOTE**

Mount the HA casing in a direction where the wiring through-holes will be hidden in order to prevent infants from putting their fingers into the HA casing and the LED light on the internal PC board from leaking outside.

### 3. Connection of wiring

Connect the wiring to the connector terminals.

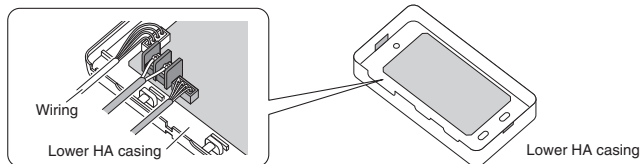

### 4. Fixation of wiring

① Insert the provided binding band under the pillar of the HA casing and secure the covers of the wiring with the binding band.

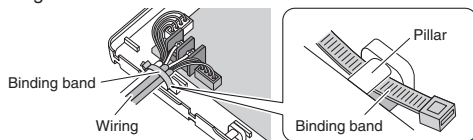

② Insert the second binding band into the groove on the side of the HA casing and fix the wiring securely so that the wiring will not be disconnected.

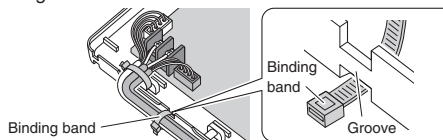

**A large number of wires**

Make a slit with an appropriate tool, such as a cutter knife, on the thin part of the upper HA casing along the frame. Then cut the part with an appropriate tool, such as a pair of nippers.

(NOTE) Cut off only the thin part required for wiring.

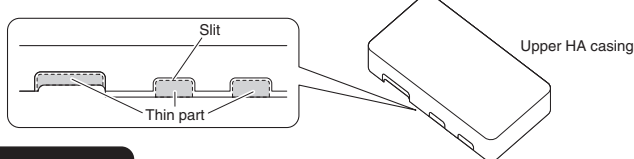

### 5. Finishing

Mount the upper HA casing to the original position.

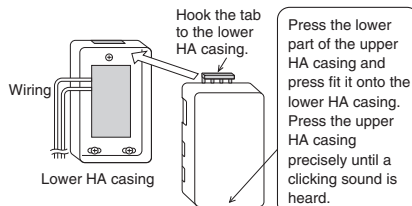

**Information**

**When the contact input device (such as card keys) and central controller are used in tandem:**

Even when the operating mode of the S1 pin is set to prohibit all remote controller actions, run/stop operation from the central controller is possible. The operation also starts when the power ON timer of the indoor unit is up while all remote controller actions are prohibited. (\*) In this case, stop the operation from the central controller. For the compatible models of the (KRC944 series) remote controller, the operation can be prohibited by using the remote controller in tandem with the central controller. \*If this product is connected to an air conditioner manufactured in or after 2011, when the contact is closed, the power ON timer may be cancelled depending on the combination with the model.

## 14.7 <KRP067A41> Interface Adaptor for Residential Air Conditioner

### Safety Considerations

- Read these **Safety Considerations** carefully to ensure correct installation.
- This manual classifies the precautions into **WARNING** and **CAUTION**. Be sure to follow all the precautions below: they are all important for ensuring safety.

**⚠ WARNING** : Failure to follow any of WARNING is likely to result in such grave consequences as death or serious injury.

**⚠ CAUTION** : Failure to follow any of CAUTION may in some cases result in grave consequences.

#### ⚠ WARNING

- **Installation shall be left to the authorized dealer or another trained professional. Improper installation may cause water leakage, electrical shock, fire, or equipment damage.**
- **Be sure to use the supplied or exact specified installation parts. Use of other parts may cause the unit to come to fall, water leakage, electrical shock, fire or equipment damage.**
- **Be sure to switch off the unit before touching any electrical parts.**
- **Be sure to install a ground fault circuit interrupter / earth leakage circuit breaker.**  
Failure to install a ground fault circuit interrupter / earth leakage circuit breaker may result in electrical shock, fire or personal injury.

#### ⚠ CAUTION

- **Do not install the air conditioner where gas leakage would be exposed to open flames.**  
If the gas leaks and builds up around the unit, it may catch fire.
- **Touch a nearby metal object (doorknob, aluminium sash, etc.) to discharge static electricity from your body before touching this set.**  
(Static electricity from your body can damage this set.)
- **Lay the cable separately from other power cables.**  
(Poor wiring may cause external electrical noise.)
- **After completing installation, test the unit to check for installation errors. Give the user adequate instructions concerning the use and cleaning of the unit according to the Operation Manual.**

### Outline / Features

This set is an interface that connects a central control device to a room air conditioner and allows you to perform the following operations, or monitoring, in combination with the central control device using KRP413AB1S or KRP928BB2S (sold separately).

- Starting and stopping the air conditioner, and setting the mode and temperature, through the central control device or the wired remote controller. (64°F to 90°F (18°C to 32°C) in COOL operation, 57°F to 82°F (14°C to 28°C) in HEAT operation, none in FAN operation)
- Monitoring the operating conditions, occurrence of errors, and contents of errors of the air conditioner through the central control device or the wired remote controller.
- Restricting the operation with a wireless remote controller found near the air conditioner, such as starting and stopping operation, changing the mode, or setting the temperature, through the use of the central control device, coin timer, or card key.
- Zone control through the central control device.
- Restoring the operating conditions of the air conditioner to the previous conditions at the time of power recovery in case of power outage.

This set does not support the following functions.

- Group control (i.e., the control of multiple indoor units through a single remote controller)
- Monitoring of the following items: Indoor temperature and operating conditions of thermo, compressor, indoor fan, electric heater, and humidifier
- Control of the following items: Forced thermo OFF, filter sign display and reset, airflow direction, airflow rate setting, and air-conditioner charge management
- Energy-saving command, low-noise command, and demand command

### Components

This set includes the following components. Please confirm them.

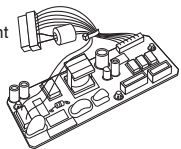
Component	Quantity	Component	Quantity
Main component 	1	Installation Manual	1

### Installation Procedure

#### Installation Position

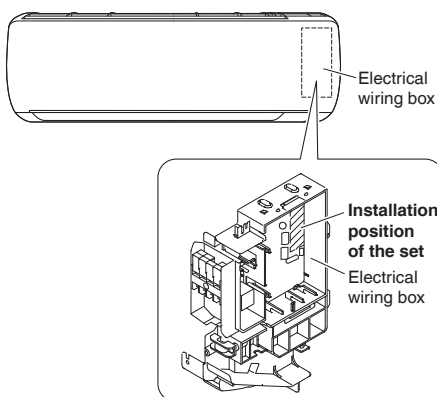

#### Wiring Outline

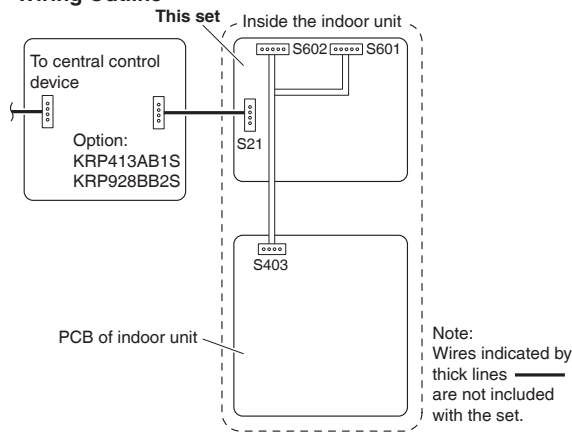



**Removal and Installation of Front Panel**

**• Removal method**

- 1) Place your fingers in the indentations on the main unit (one each on the left and right sides), and open the panel until it stops.
- 2) Continue to open the front panel further while sliding the panel to the left and pulling it toward yourself in order to disengage the rotating shaft on the left side.  
To disengage the rotating shaft on the right side, slide the panel to the right while pulling it toward yourself.

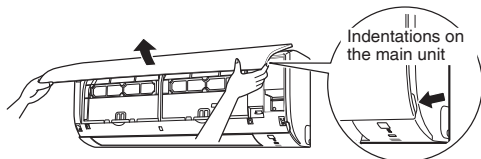

**• Installation method**

Align the rotating shaft of the front panel with the grooves, and push all the way in. Then close slowly. Push both the sides and the center of the lower surface of the panel firmly.

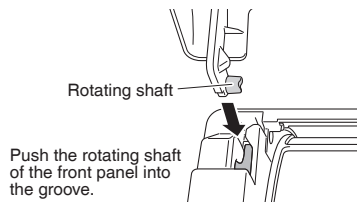

**Opening Service Lid of Indoor Unit**

The service lid is of removable type.

**• Opening method**

- 1) Remove the single screw of the service lid.
- 2) Pull out the service lid frontward.

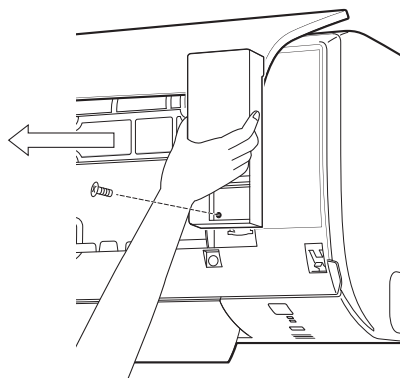

**Removal and Installation of Front Grille**

**• Removal method**

- 1) Remove front panel.
- 2) Remove the air filter.
- 3) Remove the screws (2) from the front grille.
- 4) Disengage 3 hooks (the location can be identified by ○○○ mark) at the top of the grille.

< When there is no work space because the unit is close to ceiling >

**CAUTION**

Be sure to wear protection gloves.

Disengage the flap (horizontal blade), and pull the lower part of the front grille toward yourself to remove it. If it is difficult to remove, place both hands under the center of the front grille, and while pushing up, pull it toward yourself.

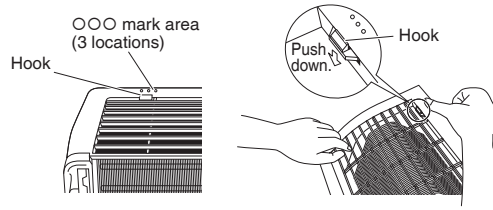
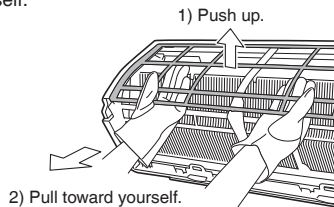

**• Installation method**

- 1) Install the front grille and firmly engage the upper hooks (3 locations).
- 2) Insert 2 screws of the front grille.
- 3) Install the air filter then mount the front panel.

### Removal of Electrical Wiring Box Cover

1. Remove the front panel and the front grille and service lid of indoor unit.  
(Refer to the front page for the removal of each part in detail.)
2. Remove the electrical wiring box cover.

**⚠ WARNING**

• Be sure to turn OFF the power at the time of installation work.  
Touching any electric parts with the power turned ON may cause electric shock.

**Electrical wiring box**  
If there is workspace on the right-hand side of the indoor unit, the installation work can be conducted without removing the electrical wiring box.

After connecting the HA PCB (this set), return all removed parts to their original positions.

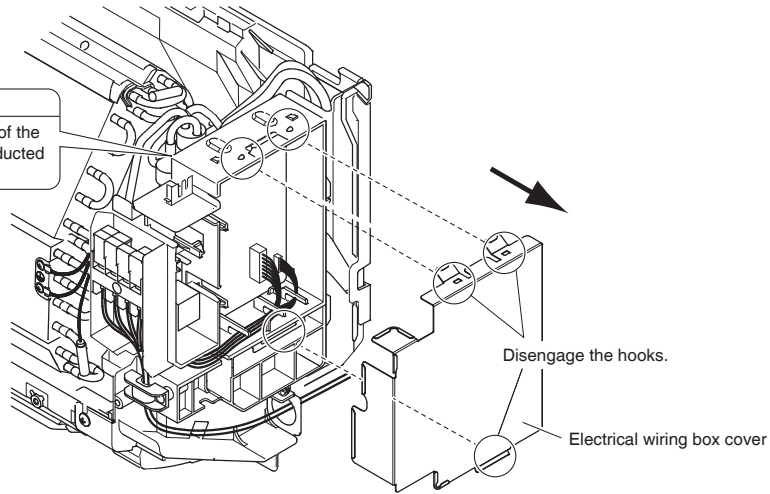

### Removal of Electrical Wiring Box

If there is workspace on the right-hand side of the indoor unit, the installation work can be conducted without removing the electrical wiring box.  
Connect HA without removing the electrical wiring box, if possible.

1. Disconnect the inter-unit wire.
2. Disconnect the fan motor connector (S200) and swing motor connector (S6).
3. Disconnect the thermistor and ground/earth wire from the heat exchanger (2 screws).  
(Some models may not have ground/earth wire.)
4. Remove the mounting screw of the electrical wiring box (1 screw).

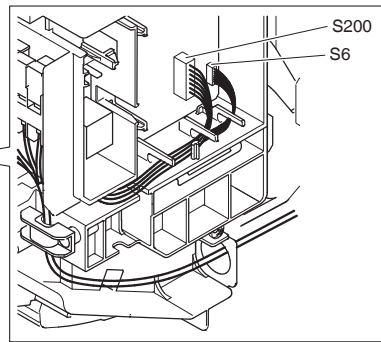
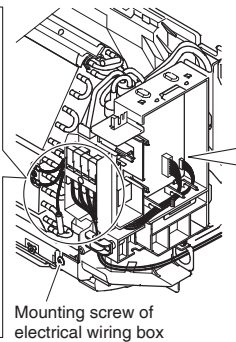
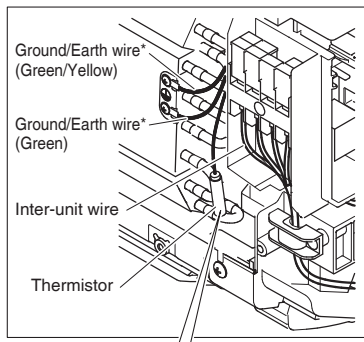

Make sure that the mounting bracket of the thermistor will not fall off.

\*The position of the ground/earth wire may differ depending on the model

After connecting the HA PCB (this set), return all removed parts to their original positions.



### Connecting HA PCB

**1. Install the HA PCB (this set). (See Fig. 1)**

- 1) Install the HA PCB (this set) to the electrical wiring box.
- 2) Insert the connector of the HA PCB (this set) to the connector (S403) on the electrical wiring box.

**2. Connect the HA connection cord. (See Fig. 1 and 2)**

- 1) Insert the HA connection cord into the HA connector "S21" (white) on the HA PCB (this set).
- 2) Route the HA connection cord as shown in Fig. 2.

**Fig. 1 Connection points of the HA PCB**

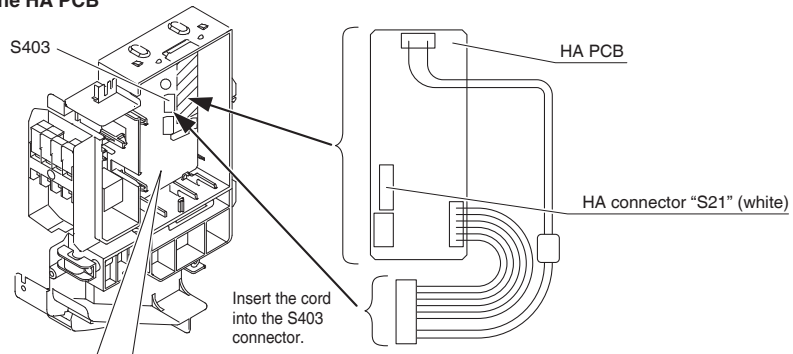

**Installing HA PCB on the electrical wiring box**

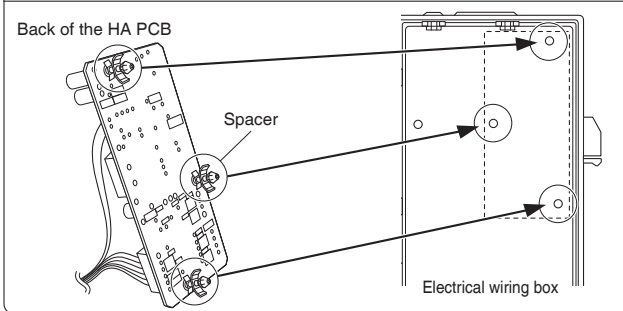

**Fig. 2 Routing HA connection cord**

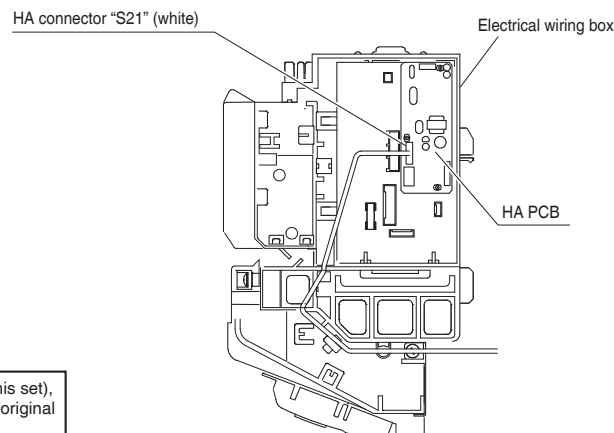

After connecting the HA PCB (this set), return all removed parts to their original positions.

## 14.8 <KRP980B2> Interface Adaptor for Residential Air Conditioner

### Safety Considerations

- Read these **Safety Considerations** carefully to ensure correct installation.
- This manual classifies the precautions into **WARNING** and **CAUTION**. Be sure to follow all the precautions below: they are all important for ensuring safety.

**⚠ WARNING** : Failure to follow any of **WARNING** is likely to result in such grave consequences as death or serious injury.

**⚠ CAUTION** : Failure to follow any of **CAUTION** may in some cases result in grave consequences.

#### ⚠ WARNING

- **Installation shall be left to the authorized dealer or another trained professional.** Improper installation may cause water leakage, electrical shock, fire, or equipment damage.
- **Be sure to use the supplied or exact specified installation parts.** Use of other parts may cause the unit to come to fall, water leakage, electrical shock, fire or equipment damage.
- **Be sure to switch off the unit before touching any electrical parts.**
- **Be sure to install a ground fault circuit interrupter.** Failure to install a ground fault circuit interrupter may result in electrical shock, fire or personal injury.

#### ⚠ CAUTION

- **Do not install the air conditioner where gas leakage would be exposed to open flames.** If the gas leaks and builds up around the unit, it may catch fire.
- **Touch a nearby metal object (doorknob, aluminium sash, etc.) to discharge static electricity from your body before touching this set.**  
(Static electricity from your body can damage this set.)
- **Lay the cable separately from other power cables.**  
(Poor wiring may cause external electrical noise.)
- **After completing installation, test the unit to check for installation errors.** Give the user adequate instructions concerning the use and cleaning of the unit according to the **Operation Manual**.

### Outline / Features

This set is an interface that connects a central control device to a room air conditioner and allows you to perform the following operations, or monitoring, in combination with the central control device using KRP413AB1S or KRP928BB2S (sold separately).

- Starting and stopping the air conditioner, and setting the mode and temperature, through the central control device or the wired remote controller. (64°F to 90°F (18°C to 32°C) in COOL operation, 57°F to 82°F (14°C to 28°C) in HEAT operation, none in FAN operation)
- Monitoring the operating conditions, occurrence of errors, and contents of errors of the air conditioner through the central control device or the wired remote controller.
- Restricting the operation with a wireless remote controller found near the air conditioner, such as starting and stopping operation, changing the mode, or setting the temperature, through the use of the central control device, coin timer, or card key.
- Zone control through the central control device.
- Restoring the operating conditions of the air conditioner to the previous conditions at the time of power recovery in case of power outage.

The set does not support the following functions.

- Group control (i.e., the control of multiple indoor units through a single remote controller)
- Monitoring of the following items: Indoor temperature and operating conditions of thermo, compressor, indoor fan, electric heater, and humidifier
- Control of the following items: Forced thermo OFF, filter sign display and reset, airflow direction, airflow rate setting, and air-conditioner charge management
- Energy-saving command, low-noise command, and demand command

### Components

This set includes the following components. Please confirm them.

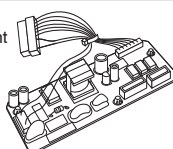
Component	Quantity	Component	Quantity
Main component 	1	Installation Manual	1

### Installation Procedure

#### Installation Position

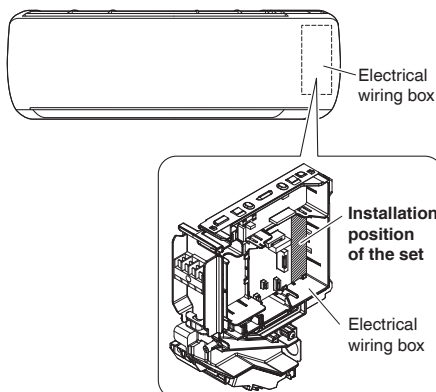

#### Wiring Outline

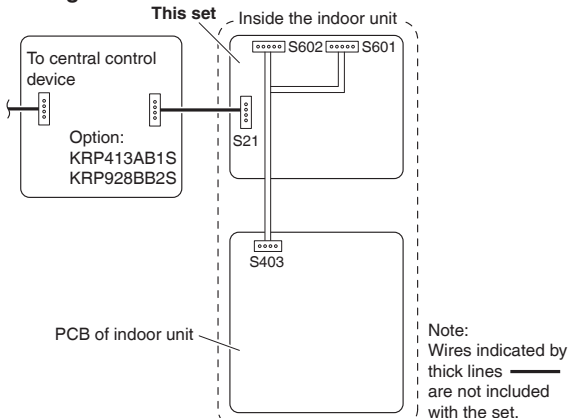

### Removal and Installation of Front Panel

**• Removal method**

- 1) Place your fingers in the indentations on the main unit (one each on the left and right sides), and open the panel until it stops.
- 2) Continue to open the front panel further while sliding the panel to the left and pulling it toward yourself in order to disengage the rotating shaft on the left side.  
To disengage the rotating shaft on the right side, slide the panel to the right while pulling it toward yourself.

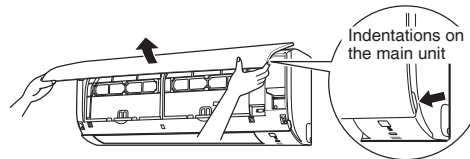

**• Installation method**

Align the rotating shaft of the front panel with the grooves, and push all the way in. Then close slowly. Push both the sides and the center of the lower surface of the panel firmly.

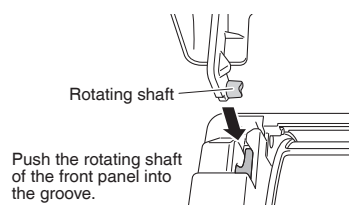

### Removal and Installation of Front Grille

**• Removal method**

- 1) Remove front panel.
- 2) Remove the air filter and streamer unit (only for models with a streamer unit).
- 3) Remove the screws (3) from the front grille.
- 4) Disengage 3 hooks (the location can be identified by ○○○ mark) at the top of the grill.

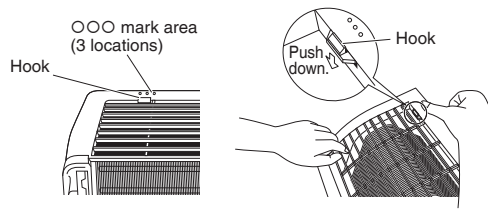

**< When there is no work space because the unit is close to ceiling >**

Disengage the flap (horizontal blade), and pull the lower part of the front grill toward yourself to remove it. If it is difficult to remove, place both hands under the center of the front grille, and while pushing up, pull it toward yourself.

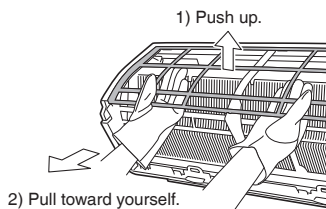

**⚠ CAUTION**  
Be sure to wear protection gloves.

**• Installation method**

- 1) Install the front grille and firmly engage the upper hooks (3 locations).
- 2) Insert 3 screws of the front grille.
- 3) Install the air filter then mount the front panel.

### Removal of Electrical Wiring Cover

1. Remove the front panel and the front grille.  
(Refer to the front page for the removal of each part in detail.)
2. Remove the electrical wiring cover.

**⚠ WARNING**

- Be sure to turn OFF the power at the time of installation work.  
Touching any electric parts with the power turned ON may cause electric shock.

**Electrical wiring box**

If there is workspace on the right-hand side of the indoor unit, the installation work can be conducted without removing the electrical wiring box.

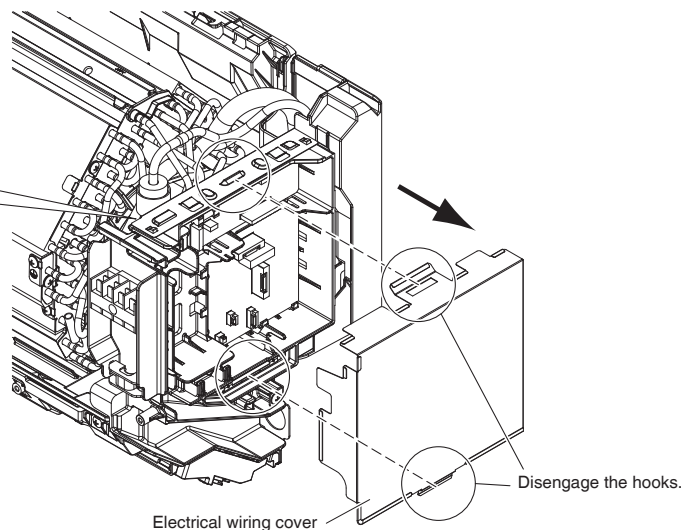

### Removal of Electrical Wiring Box

If there is workspace on the right-hand side of the indoor unit, the installation work can be conducted without removing the electrical wiring box.  
Connect HA without removing the electrical wiring box, if possible.

1. Disconnect the contact wire.
2. Disconnect the fan motor connector (S200) and swing motor connector (S6, S11).  
(Some models may not have S11 connector.)
3. Disconnect the thermistor and ground wire from the heat exchanger (two screws).  
(Some models may not have ground wire.)
4. Remove the mounting screw of the electrical wiring box (one screw).

Ground wire\*  
(Green/Yellow)

Ground wire\*  
(Green)

Thermistor

Make sure that the mounting bracket of the thermistor will not fall off.

\* The position of the ground wire may differ depending on the model.

Mounting screw of electrical wiring box

contact wire

S6

S200

### Connecting HA PCB

**1. Install the HA PCB (this set). (See Fig. 1)**

- 1) Install the HA PCB (this set) to the electrical wiring box.
- 2) Insert the connector of the HA PCB (this set) to the connector (S403) on the electrical wiring box.

**2. Connect the HA connection cord. (See Fig. 1 and 2)**

- 1) Insert the HA connection cord into the HA connector, "S21" (white) on the HA PCB (this set).
- 2) Route the HA connection cord as shown in Fig. 2.

**Fig. 1 Connection points of the HA PCB**

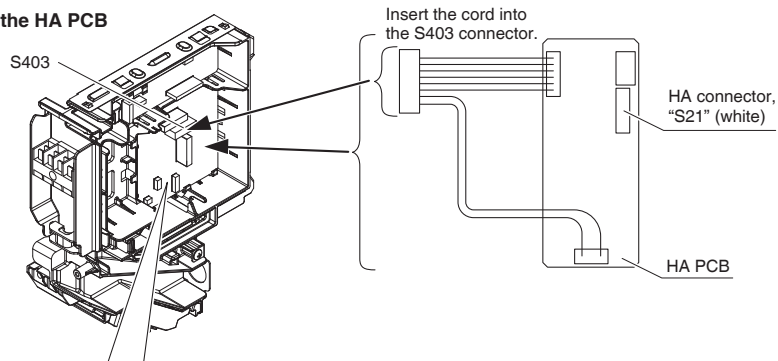

**Installing HA PCB on the electrical wiring box**

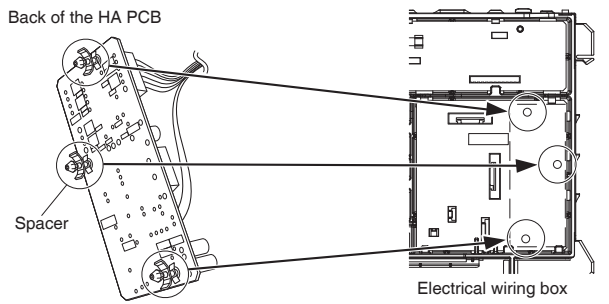

**Fig. 2 Routing HA connection cord**

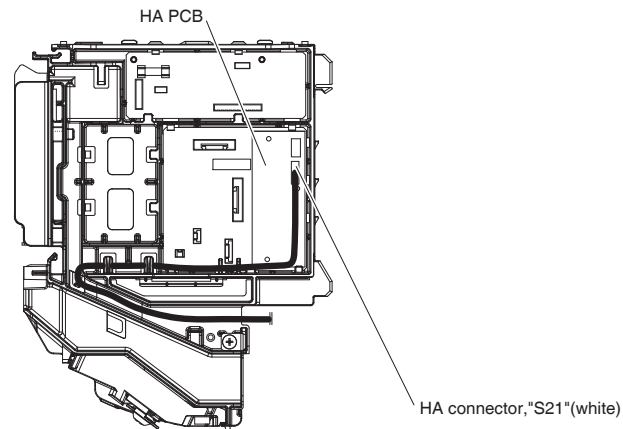

## 14.9 <DCS302C71> Central Remote Controller Installation Manual

Please read these "SAFETY CONSIDERATIONS" carefully before installing air conditioning equipment and be sure to install it correctly. After completing the installation, make sure that the unit operates properly during the start-up operation. Please instruct the customer on how to operate the unit and keep it maintained. Also, inform customers that they should store this installation manual along with the operation manual for future reference. This air conditioner comes under the term "appliances not accessible to the general public".

Meaning of warning, caution and note symbols.

- ⚠ WARNING** ..... Indication a potentially hazardous situation which, if not avoided, could result in death or serious injury.
- ⚠ CAUTION** ..... Indication a potentially hazardous situation which, if not avoided, may result in minor or moderate injury. It may also be used to alert against unsafe practices.
- ⚠ NOTE** ..... Indication situation that may result in equipment or property-damage-only accidents.

### ⚠ WARNING

**Ask your dealer or qualified personnel to carry out installation work. Do not try to install the machine by yourself.** Improper installation may result in water leakage, electric shocks or fire.

**Perform installation work in accordance with this installation manual.** Improper installation may result in water leakage, electric shocks or fire.

**Be sure to use only the specified accessories and parts for installation work.** Failure to use the specified parts may result in water leakage, electric shocks, fire or the unit falling.

**Carry out the specified installation work after taking into account strong winds, typhoons or earthquakes.** Improper installation work may result in the equipment falling and causing accidents.

**Make sure that a separate power supply circuit is provided for this unit and that all electrical work is carried out by qualified personnel according to local laws and regulations and this installation manual.** An insufficient power supply capacity or improper electrical construction may lead to electric shocks or fire.

**Make sure that all wiring is secured, the specified wires and used, and no external forces act on the terminal connections or wires.** Improper connections or installation may result in fire.

**When wiring the power supply and connecting the remote controller wiring and transmission wiring, position the wires so that the electric parts box lid can be securely fastened.** Improper positioning of the electric parts box lid may result in electric shocks, fire or the terminals overheating.

**Before touching electrical parts, turn off the unit.**

**Ground the air conditioner. Do not connect the ground wire to gas or water pipes, lightning rod or a telephone ground wire.** Incomplete grounding may result in electric shocks.

**When installing or relocating the system, be sure to keep the refrigerant circuit free from substances other than the specified refrigerant (R410A), such as air.**

**Do not reconstruct or change the settings of the protection devices.** If the pressure switch, thermal switch, or other protection device is shorted and operated forcibly, or parts other than those specified by Daikin are used, fire or explosion may result.

**Do not touch the switch with wet fingers.** Touching a switch with wet fingers can cause electric shock.

**Install an leak circuit breaker, as required.** If an leak circuit breaker is not installed, electric shock may result.

**Do not install the air conditioner or the remote controller in the following locations:**

- (a) where a mineral oil mist or an oil spray or vapor is produced, for example in a kitchen  
Plastic parts may deteriorate and fall off or result in water leakage.
- (b) where corrosive gas, such as sulfurous acid gas, is produced  
Corroding copper pipes or soldered parts may result in refrigerant leakage.
- (c) near machinery emitting electromagnetic waves  
Electromagnetic waves may disturb the operation of the control system and result in a malfunction of the equipment.
- (d) where flammable gases may leak, where there are carbon fiber or ignitable dust suspensions in the air, or where volatile flammables such as thinner or gasoline are handled.  
Operating the unit in such conditions may result in fire.

### ⚠ CAUTION

**Be very careful about product transportation.**

**Safely dispose of the packing materials.** Packing materials, such as nails and other metal or wooden parts, may cause stabs or other injuries. Tear apart and throw away plastic packaging bags so that children will not play with them. If children play with a plastic bag which was not torn apart, they face the risk of suffocation.

**Do not turn off the power immediately after stopping operation.** Always wait at least five minutes before turning off the power. Otherwise, water leakage and trouble may occur.

### ⚠ NOTE

**Install the indoor and outdoor units, power supply wiring and connecting wires at least 3.5ft. away from televisions or radios in order to prevent image interference or noise.** (Depending on the radio waves, a distance of 3.5ft. may not be sufficient enough to eliminate the noise.)

**Remote controller (wireless kit) transmitting distance can result shorter than expected in rooms with electronic fluorescent lamps.(inverter or rapid start types)** Install the indoor unit as far away from fluorescent lamps as possible.

**This unit is a class A product.** In a domestic environment this product may cause radio interference in which case the user may be required to take adequate measures.

**Dismantling of the unit, treatment of the refrigerant, oil and eventual other parts, should be done in accordance with the relevant local and national regulations.**

# 1 COMPONENTS

Check the following components are included in this optional accessory before installation.

Installation screw (M4 x 16)	4
Operation manual	1
Installation manual	1
Installation table	1

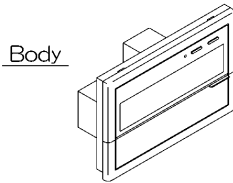

When using this optional accessory an electric parts box of KJB311A is required. For installation, a steel electric parts box to be embedded is mandatory.

# 2 SYSTEM CONFIGURATION

With the central remote controller, unified operation/stop is possible with up to a maximum 64 groups of indoor units. When using 2 central remote controllers, unified operation is possible with up to a maximum 128 groups. With this optional accessory, setting of control modes including operation, stop, operation controlled by timer, and ON/OFF control possible/impossible by remote controller can be set individually by zones while it enables to control and display the operation state such as set temperature. It can be connected with the external key system, host computer monitor panel, etc., through forced OFF input (no-voltage normally open contactor). A zone is a one or more groups together. In general, the same settings are used throughout a zone.

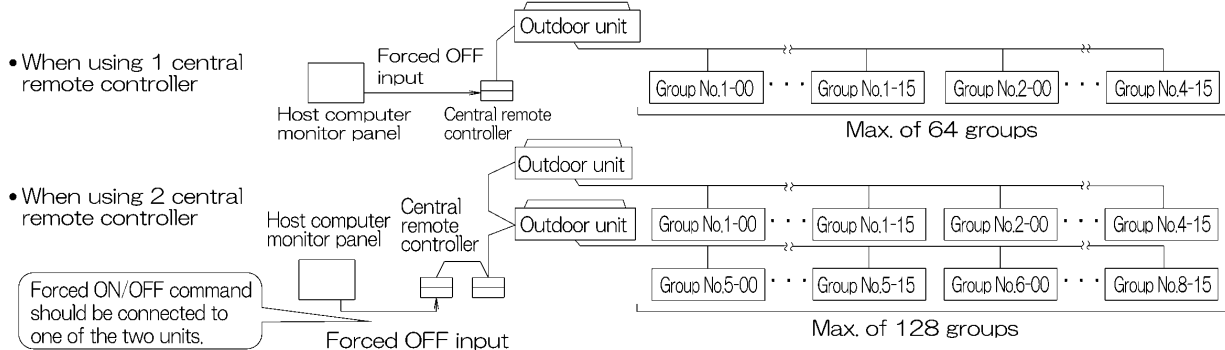

The central remote controller and the separately sold remote control adapter circuit board or group remote control adapter cannot be used together. See the D-BACS design guide for details.

# 3 INSTALLATION

(1) Open the upper part of remote controller. Insert a ⊖ screwdriver (2 locations) into the recess between the upper part and the lower part of remote controller and twist the screwdriver lightly.

PC board is attached with both the upper and lower part of remote controller. Do not damage the board with the screwdriver.

(2) Open the upper part of remote controller and install the Electric parts box with the attached installation screws (M4 x 16).

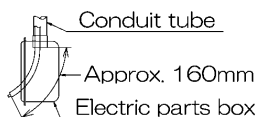

Installation screws (4)

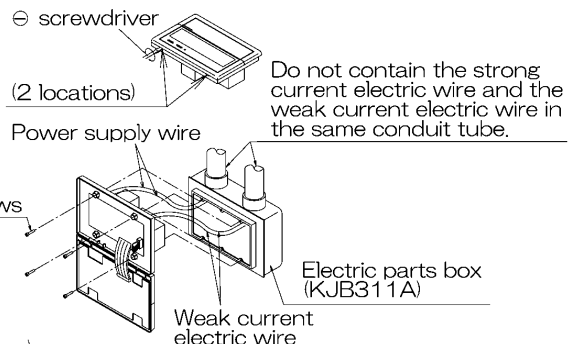

NOTE) Suitable length of the electric wire is about 160mm. (from electric parts box) If it is difficult to contain a long wiring, strip the sheathed part of the wiring.



# 4 INITIAL SETTING

Setting (1) through (3) are initialized when power is turned ON, therefore complete settings BEFORE activating the power. (The positions of connectors and switches used for settings in this section are shown in Fig. 1)

- Connector for setting master controller (X1A) (Provided with connector at factory set)
  - When using only 1 central remote controller, do not disconnect the connector for setting master controller. (Use the unit with the connector in the state in which it was delivered.)
  - When using multiple central remote controllers, or using the central remote controller in conjunction with the optional controllers for centralized control, makes settings as indicated in the below table.

Pattern of connection of optional controllers for centralized control			Connector for setting master controller (X1A) Setting, Removed		
Central remote controller	Unified ON/OFF controller	Schedule timer	Central remote controller	Unified ON/OFF controller	Schedule timer
1 to 4	1 to 16	1	Set one to "Used" and all the rest to "Not used"	Set all to "Not used"	"Not used"
		1			"Not used"

(Remove all the connectors for the central remote controller, the on/off controller, and the schedule timer when using the unit together with the Ve-UP controller, the master station II, the DMS interface, the payment management unit, or the parallel interface station.)

- Address setting  
Two central remote controllers can be used as shown in **2 SYSTEM CONFIGURATION**, to control anywhere up to a max. 128 groups of indoor units. In this case, group address must be set. This is done with the switch for setting each address (SS3).

SS3 setting	Indoor unit address	SS3 setting	Indoor unit address
SETTING EACH ADDRESS 5-00 ~ 8-15	To control indoor units from group Nos. 1-00 through 4-15	SETTING EACH ADDRESS 5-00 ~ 8-15	To control indoor units from group Nos. 5-00 through 8-15

- MAIN/SUB changeover switch setting  
With two central remote controllers, centralized control (indoor units) is possible from different locations. In this kind of set-up, it is necessary to set the MAIN/SUB changeover switch.

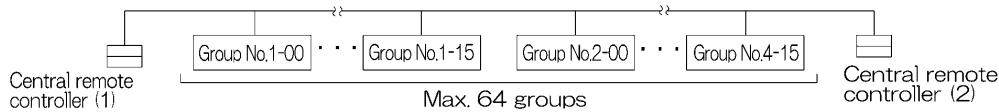

One of the two central remote controllers (1) . (2) is set to "MAIN" while the other is set to "SUB".

- Setting of the sequential operation function  
The central remote controller is equipped with a sequential operation function that sequentially turns indoor units on in 2-second intervals during unified operation. (Sequential operation is factory set to "ON.") To switch sequential operation ON or OFF, set as follows.

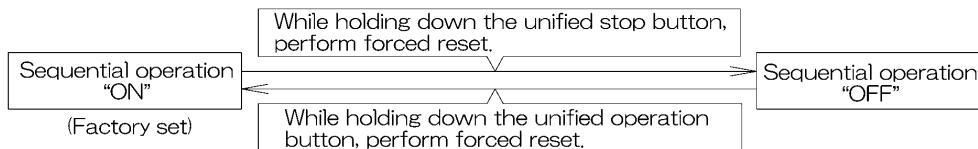

NOTE: The sequential operation function is designed to reduce the load on the power supply equipment, but does not guarantee that compressors will not be started simultaneously. You cannot therefore count on a capacity reduction effect by power supply equipment breaker selection.

- Forced reset switch  
When changing the setting of the connector for setting master controller, etc., you can reset simply by setting it to the reset side once and returning to the normal side, without turning the power OFF. (For normal operation, set the switch to the normal side.)

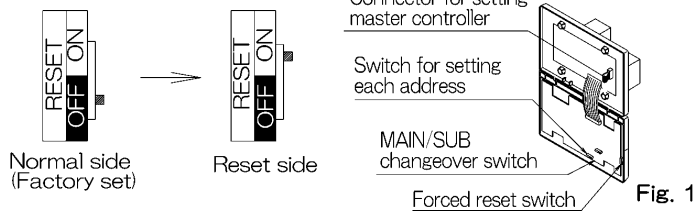
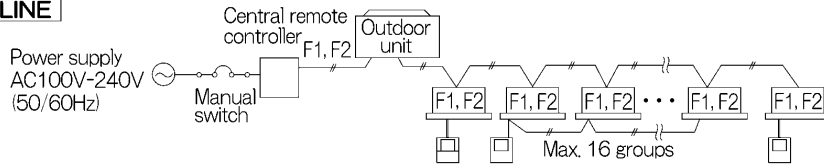

Fig. 1



## 5 ELECTRIC WIRING

### WIRING OUTLINE



### WIRING TO THE INDOOR UNIT AND OUTDOOR UNIT

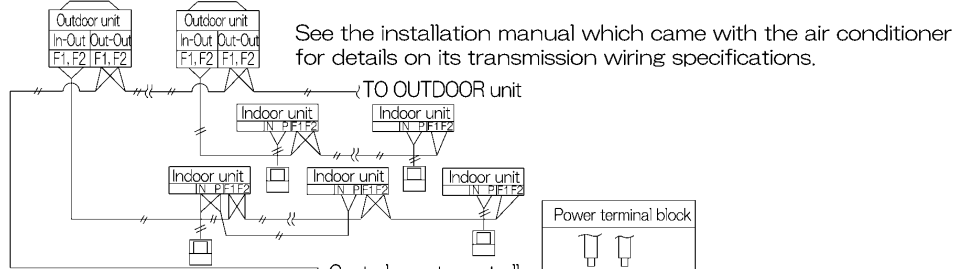

**Batch remote control adapter Connector (X2A)**  
 Separately sold batch remote control adapter.  
 Used for DCS302A72 connections.  
 See the instruction manual included with the batch remote control adapter for details.

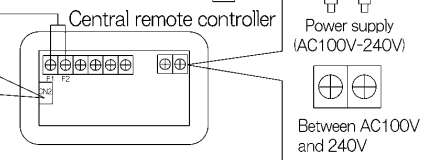

#### Wiring specifications

Power supply wiring	2mm <sup>2</sup>
Transmission wiring for control	0.75 – 1.25 mm <sup>2</sup> sheathed vinyl cord or cable (balanced type) – maximum length 1000 m (total overall wiring length 2000 m)
Manual switch	10A or 15A

Wire the indoor units to the outdoor units and between all power, indoor units, and remote controllers. See the instruction manual included with the indoor and outdoor units for details.

#### CONTROL TERMINAL STRIP

- \*1 For connecting Indoor unit (F1, F2)
- \*2 Forced OFF input (T1, T2)  
 None of the indoor units connected to the forced OFF input contact (non-voltage contact with minimal current) will operate when it is shut off.  
 Use only contactors which guarantee the minimum applicable load DC 16V, 10mA.  
 T1 ——— | DC16V  
 T2 ——— |  
 NOTE) Use instantaneous contactor of over 200m sec. energizing time, when necessary.
- \*3 For schedule timer (D1, D2)  
 Power can be supplied to the schedule timer (DST301B61) separately sold. For details, refer to the installation manual of the schedule timer.  
 Wire \*2 and \*3 only when necessary.

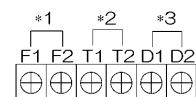

#### (NOTE)

Do not connect the power supply wiring (100 to 240V) to the control terminal strip. If connected by mistake, it may damage or burn electrical parts of optional controllers for centralized control and indoor unit. It may result in serious danger. Be sure to check wirings before turning the power ON.

## 6 SETTING GROUP NO. FOR CENTRALIZED CONTROL

Set the group number of each group of the indoor unit from the remote controller. (In case of no remote controller, also connect the remote controller and set the group No. Then, remove the remote controller.)

- (1) Turn ON the power of the indoor unit and central remote controller.  
(Unless the power is ON, no setting can be made.)  
Check that the installation and electrical wiring are correct before turning the power supply ON.  
(When the power supply is turned ON, all LCD appear once and the unit may not accept the operation for about one minute with the display of "88".)
- (2) While in the normal mode, hold down the "TEST" button for a minimum of 4 seconds.  
The remote controller will enter the FIELD SET MODE.
- (3) Select the MODE No. "00" with the "MODE" button.
- (4) Use the "GROUP" button to select the group No. for each group.  
(Group numbers increase in the order of 1-00,1-01,...1-15, 2-00,...8-15.)
- (5) Press "MODE" to set the selected group No.
- (6) Press "TEST" to return to the NORMAL MODE.

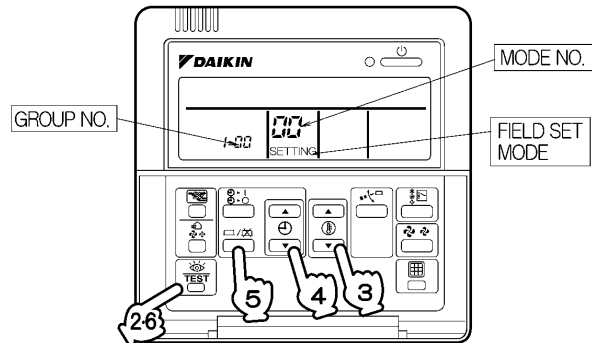

- NOTES)
- For simplified remote controller, see the installation table.
  - See the instruction manuals which came with the Ventiair and adapters (i.e., multi-purpose adapters) for details on their Group No. settings.

**NOTICE** Enter the group No. and installation place of the indoor unit into the installation table in the operation manual. Be sure to keep the operation manual for maintenance.

## 7 TEST OPERATION (Perform a test operation in the individual screen before registering zones.)

Before starting test operation, check that the power is supplied to the indoor and outdoor units, and central remote controller.

- (1) Select the display "INDIVIDUALLY"  
Press "ALL INDIVIDUAL" button to display "INDIVIDUALLY"
- (2) Select the group to be tested.  
Select the group No. with "←" "→" "↑" "↓" button.
- (3) Press "TEST" button to select the test operation mode.  
"TEST" is displayed.  
"HOST" is displayed on the remote controller.
- (4) Press "TEST" button within 10 seconds after entering into the test operation mode.  
Operation the unit for 30 minutes.  
When pressing the "TEST" button, the unit stops operating.  
If the operation lamp flashes, it indicates a malfunction.  
Call the group of flashing display, confirm malfunction code, and check the source of malfunction.  
(The operation manual lists all error codes, so refer to it.)

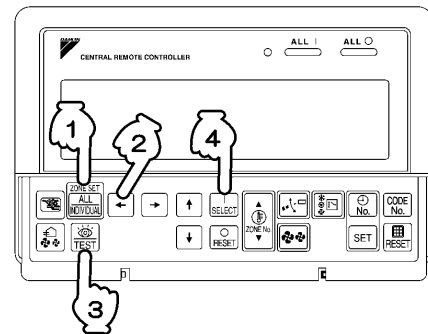

- NOTES)
- For test operation, refer to the installation manual of the outdoor unit.
  - After turning the power supply ON, if the unit does not accept operation for two minutes or more with the display of "88", check the following points.
    - Check that setting of the connector for setting master controller is correct.
    - Check that the group No. for centralized control has been set.

# 14.10 <DCS302C71> Central Remote Controller Operation Manual

## BEFORE USE

### ■ GENERAL DESCRIPTION OF SYSTEM

This central remote controller can monitor and control up to 64 indoor unit groups. Using two central remote controllers allows monitoring and controlling of up to 128 indoor unit groups.

#### Main Functions

1. Batch starting and stopping of indoor units connected to the central remote controller.
2. Handling of operation settings such as start/stop, timer operation, remote controller prohibition/permission, etc., and operation status settings such as temperature.
3. Operation status monitoring of operation mode, set temperature, etc.
4. Can be connected to an external central monitor panel and key system using the forced stop input (non-voltage a connector).

- When using 1 central remote controller

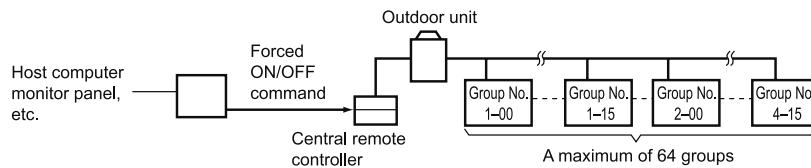

- When using 2 central remote controllers

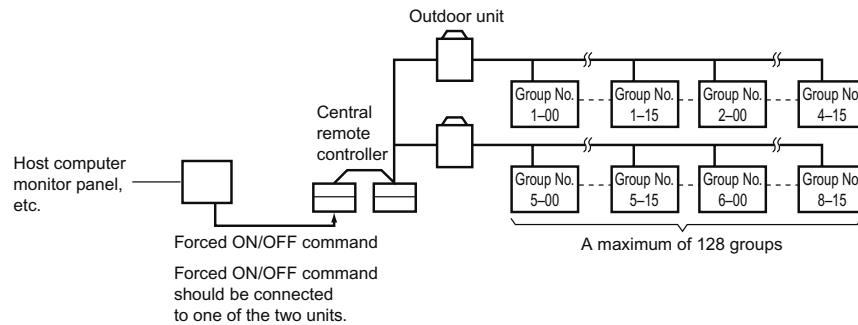

(The central remote controller and the separately sold remote control adapter circuit board or group remote control adapter cannot be used together.)

\* GROUP OF INDOOR UNIT refers to the below.

1. A single indoor unit without remote controller

1. A single indoor unit without remote controller

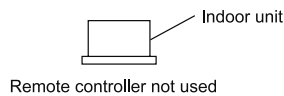

2. A single indoor unit controlled by one or two remote controllers

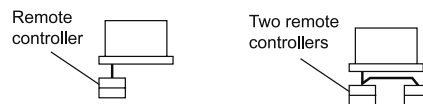

3. Maximum of 16 indoor units, group-controlled by one or two remote controllers

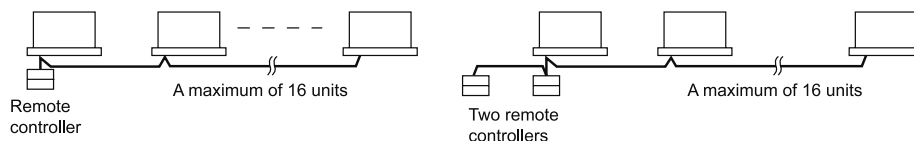

\* Zone control from the central remote controller  
 Zone control is available from the central remote controller. With it, it is possible to make unified settings for multiple groups, so setting operations are greatly simplified.

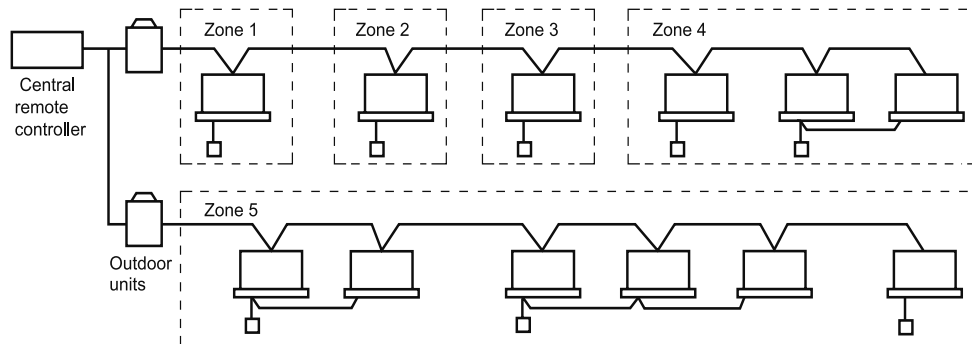

- Any setting you make within a given zone will apply to all groups in the said zone.
- A maximum of 64 zones can be set from a single central remote controller. (Each zone contains a maximum of 64 groups.)
- Zones can be set randomly from the central remote controller.

### SAFETY CONSIDERATIONS

Please read these "SAFETY CONSIDERATIONS" carefully before installing air conditioning equipment and be sure to install it correctly. After completing the installation, make sure that the unit operates properly during the start-up operation. Please instruct the customer on how to operate the unit and keep it maintained. Also, inform customers that they should store this installation manual along with the operation manual for future reference. This air conditioner comes under the term "appliances not accessible to the general public".

Meaning of danger, warning, caution and note symbols.

- ⚠ DANGER** .... Indicates an imminently hazardous situation which, if not avoided, will result in death or serious injury.
- ⚠ WARNING** .... Indicates a potentially hazardous situation which, if not avoided, could result in death or serious injury.
- ⚠ CAUTION** .... Indicates a potentially hazardous situation which, if not avoided, may result in minor or moderate injury. It may also be used to alert against unsafe practices.
- ⚠ NOTE** ..... Indicates situation that may result in equipment or property-damage-only accidents.

**Keep these warning sheets handy so that you can refer to them if needed.**  
 Also, if this equipment is transferred to a new user, make sure to hand over this operation manual to the new user.

#### ⚠ DANGER

- Any abnormalities in the operation of the air conditioner such as smoke or fire could result in severe injury or death. Turn off the power and contact your dealer immediately for instructions.
- Do not install the unit in an area where flammable materials are present due to risk of explosion resulting in serious injury or death.
- Safely dispose of the packing materials. Packing materials, such as nails and other metal or wooden parts, may cause stabs or other injuries. Tear apart and throw away plastic packaging bags so that children will not play with them. Children playing with plastic bags face the danger of death due to suffocation.

#### ⚠ WARNING

- Ask your dealer for installation of the air conditioner. Incomplete installation performed by yourself may result in a water leakage, electric shock, and fire.
- Ask your dealer for improvement, repair, and maintenance. Incomplete improvement, repair, and maintenance may result in a water leakage, electric shock, and fire.
- Improper installation or attachment of equipment or accessories could result in electric shock, short-circuit, leaks, fire or other damage to the equipment. Be sure only to use accessories made by Daikin which are specifically designed for use with the equipment and have them installed by a professional.
- Ask your dealer to move and reinstall the air conditioner or the remote controller. Incomplete installation may result in a water leakage, electric shock, and fire.
- Never let the indoor unit or the remote controller get wet. It may cause an electric shock or a fire.

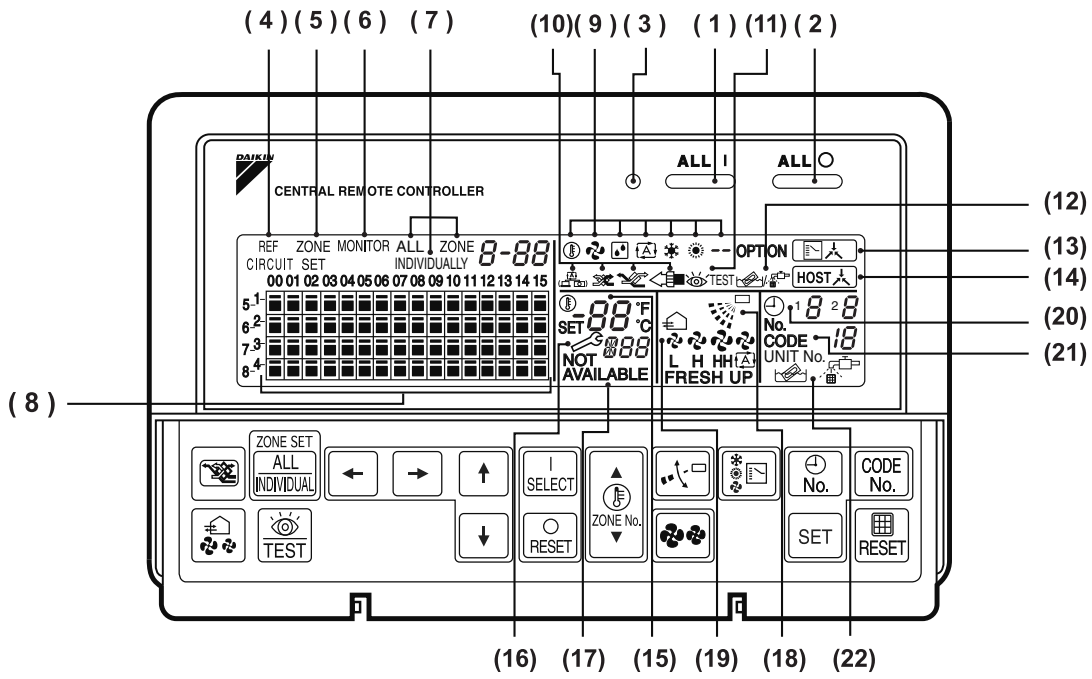

Fig. 1

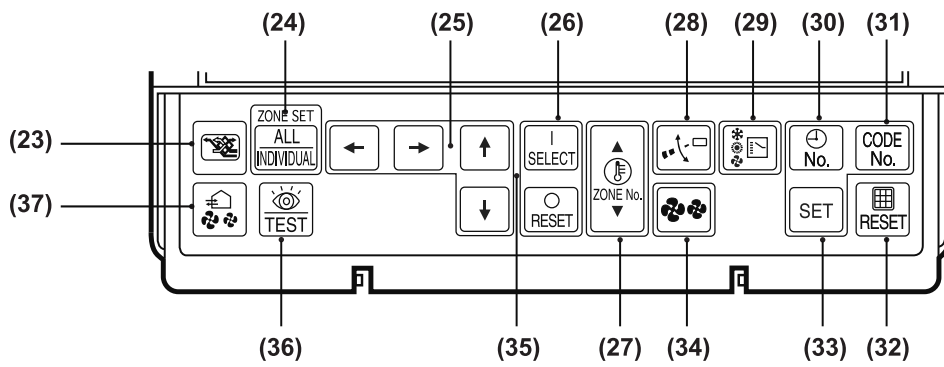

Fig. 2

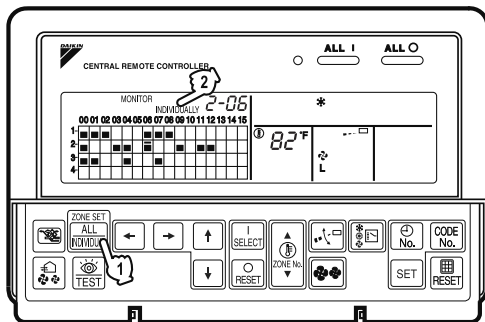

Fig. 3

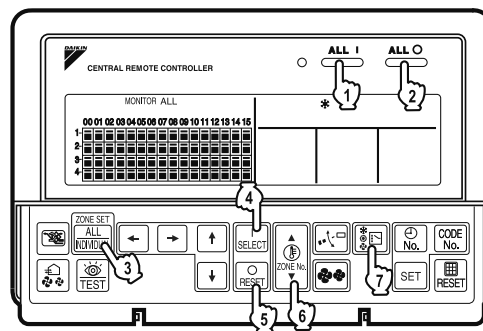

Fig. 4

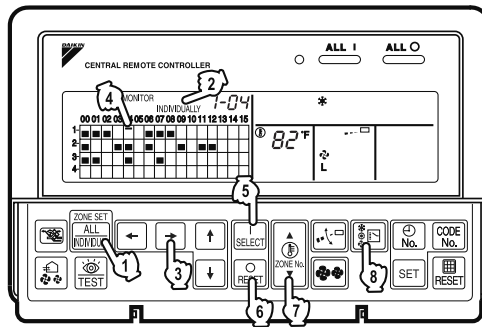

Fig. 5

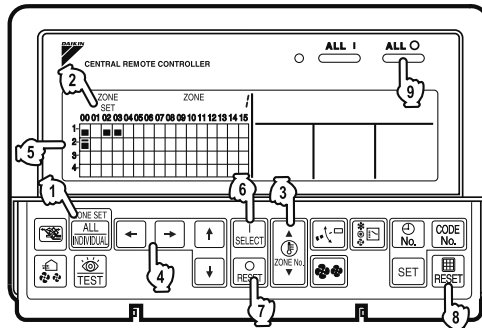

Fig. 6

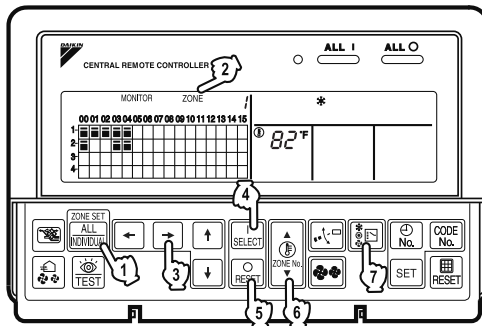

Fig. 7

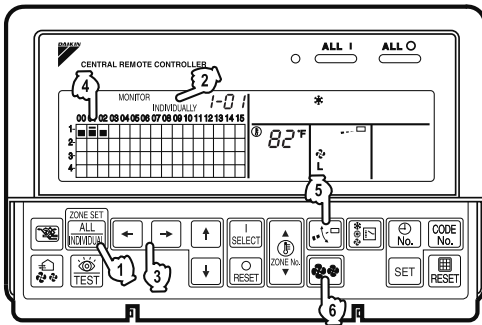

Fig. 8

- **Never use flammable spray such as hair spray, lacquer or paint near the unit.**  
It may cause a fire.
- **Do not allow children to play on or around the unit as they could be injured.**
- **Never replace a fuse with that of wrong ampere ratings or other wires when a fuse blows out.**  
Use of wire or copper wire may cause the unit to break down or cause a fire.
- **Never inspect or service the unit by yourself.**  
Ask a qualified service person to perform this work.
- **Cut off all electric waves before maintenance.**
- **Do not wash the air conditioner or the remote controller with excessive water.**  
Electric shock or fire may result.
- **Do not touch the switch with wet fingers.**  
Touching a switch with wet fingers can cause electric shock.
- **Never touch the internal parts of the controller.**  
Do not remove the front panel because some parts inside are dangerous to touch. In addition, some parts may be damaged by touching. For checking and adjusting internal parts, contact your dealer.
- **Check the unit stand for damage on a continuous basis, especially if it had been in use for a long time.**  
If left in a damaged condition the unit may fall and cause injury.
- **Placing a flower vase or other containers with water or other liquids on the unit could result in a shock hazard or fire if a spill occurs.**

**CAUTION**

- **Avoid placing the controller in a spot splashed with water.**  
Water coming inside the machine may cause an electric leak or may damage the internal electronic parts.

- **Do not operate the air conditioner when using a room fumigation - type insecticide.**  
Failure to observe could cause the chemicals to become deposited in the unit, which could endanger the health of those who are hypersensitive to chemicals.
- **Do not turn off the power immediately after stopping operation.**  
Always wait at least five minutes before turning off the power. Otherwise, water leakage and trouble may occur.
- **The appliance is not intended for use by young children or infirm persons without supervision.**
- **The remote controller should be installed in such a way that children cannot play with it.**

**NOTE**

- **Never press the button of the remote controller with a hard, pointed object.**  
The remote controller may be damaged.
- **Never pull or twist the electric wire of the remote controller.**  
It may cause the unit to malfunction.
- **Do not place the controller exposed to direct sunlight.**  
The LCD display may get discolored, failing to display the data.
- **Do not wipe the controller operation panel with benzine, thinner, chemical dustcloth, etc.**  
The panel may get discolored or the coating peeled off. If it is heavily dirty, soak a cloth in water-diluted neutral detergent, squeeze it well and wipe the panel clean. And wipe it with another dry cloth.
- **Dismantling of the unit, treatment of the refrigerant, oil and eventual other parts, should be done in accordance with the relevant local and national regulations.**

**CONTENTS**

<b>BEFORE USE</b> .....	1	<b>OPERATION MODE</b> .....	13
GENERAL DESCRIPTION OF SYSTEM .....	1	Setting operation mode .....	16
<b>SAFETY CONSIDERATIONS</b> .....	2	Group monitoring .....	16
<b>FEATURES AND FUNCTIONS</b> .....	6	Error diagnosing function .....	17
<b>NAMES AND FUNCTIONS OF THE</b>		Setting master remote controller .....	20
<b>OPERATING SECTION</b> .....	7	Display of time to clean .....	21
<b>OPERATION</b> .....	8	<b>INSTALLATION TABLE</b> .....	22
Individual screen, all screen, zone screen .....	8	<b>OPTIONAL ACCESSORIES</b> .....	23
Batch operation and stop method .....	9	<b>DOUBLE CENTRAL REMOTE</b>	
Group operation and stop method .....	9	<b>CONTROLLERS</b> .....	23
Registering zones .....	9	<b>SPECIFICATIONS</b> .....	24
Zone operation and stop method .....	10	Specifications .....	24
Changing the fan direction and fan strength .....	11	Outline drawings .....	24
Changing the ventilation mode and			
ventilation strength .....	11	Fig. 1, 2, 3, 4 .....	3
Timer Number Setting .....	11	Fig. 5, 6, 7, 8 .....	4
Setting the Operation Code .....	12	Fig. 9, 10, 11, 12 .....	25
		Fig. 13, 14, 15, 16 .....	26

## FEATURES AND FUNCTIONS

### ■ Operation menu

This central remote controller can operate and stop machines by either group or zone.  
Batch operation and batch stop functions are also available. When used in combination with the schedule timer (optional accessory), timer operation and stop functions are available.



See page  
8—12.

### ■ Various operation modes.

You can operate the system from both this unit and the remote controller, so to enable various operation control patterns. Twenty different operation modes are available including five operation patterns:

1. Start/stop: remote controller prohibition, remote controller stop-only permission, central priority, after-press priority, remote controller permission timer
2. Operation modes: remote controller prohibition, remote controller permission
3. Set temperature: remote controller prohibition, remote controller permission



See page  
13—15.

### ■ Zone control for simpler setting procedures

You can control a maximum of 64 groups of indoor units by using this central remote controller. You don't have to repeat the same setting operations by group because you can make each of the following settings by zone.

A functions is available for setting all groups in one batch.

- Operation mode
- Control mode
- Setting temperature
- Programming time No. (Used in conjunction with the schedule timer)



See page  
8—16.

### ■ Monitoring all indoor unit information

The following information can be displayed by group.

- Operation information such as operation mode, set temperature, etc., for indoor units
- Maintenance information such as cleaning signs for filters or elements
- Error codes and other malfunction diagnosis information



See page  
16—21.

### ■ Function of refrigerant system display

This display helps you understand, at a glance, the indoor units sharing the same outdoor unit and the particular indoor unit among them that is set as the master remote controller.





See page 20.

- Room air conditioners and multi-purpose air conditioners may also be connected by using separately-sold adapter boards.  
This may limit functionality, so consult the manuals that come with each adapter board.



**NAMES AND FUNCTIONS OF THE OPERATING SECTION (Fig. 1, 2)**

1	<b>UNIFIED OPERATION BUTTON</b>	Press to operate all indoor units.
	<b>UNIFIED STOP BUTTON</b>	Press to stop all indoor units.
3	<b>OPERATION LAMP (RED)</b>	Lit white any of the indoor units under control is in operation.
	<b>“<sup>REF</sup> CIRCUIT ” DISPLAY (REFRIGERANT SYSTEM DISPLAY)</b>	This indication in the square is lit while the refrigerant system is being displayed.
5	<b>“ ZONE SET ” DISPLAY (ZONE SETTING)</b>	The lamp is lit while setting zones.
	<b>“ MONITOR ” DISPLAY (OPERATION MONITOR)</b>	The lamp is lit while operation is being monitored.
7	<b>“ ALL ” “ ZONE ” “ INDIVIDUALLY ” DISPLAY</b>	The status displays indicates either batch functions or which zone or individual unit (or group) are being used.
	<b>OPERATION MONITOR</b>	Each square displays the state corresponding to each group.
9	<b>“  ” “  ” “  ” “  ” “  ” “  ” “ -- ” DISPLAY (OPERATION MODE)</b>	Displays operating state.
	<b>“  ” “  ” “  ” “  ” DISPLAY (VENTILATION CLEANING DISPLAY)</b>	This is displayed when a Ventiair total enthalpy heat exchanger unit or other such unit is connected.
11	<b>“  TEST ” DISPLAY (INSPECTION/TEST)</b>	Pressing the maintenance/test run button (for service) displays this. This button should not normally be used.
	<b>“  /  ” DISPLAY (TIME TO CLEAN)</b>	It lights up when any individual unit (group) has reached the time for the filter or element to be cleaned.
13	<b>“  ” DISPLAY (COOLING/HEATING SELECTION PRIVILEGE NOT SHOWN)</b>	For zones or individual units (groups) for which this is displayed, cooling and heating cannot be selected.
	<b>“  ” DISPLAY (UNDER HOST COMPUTER INTEGRATED CONTROL)</b>	While this display is lit up, no settings can be made. It lights up when the upper central machines are present on the same air conditioning network.
15	<b>“  SET 00 °F ” DISPLAY (PRESET TEMPERATURE)</b>	Displays the preset temperature.
	<b>“  U4 ” DISPLAY (MALFUNCTION CODE)</b>	This displays (flashes) the content of errors when an error failure has occurred. In maintenance mode, it displays the latest error content.
17	<b>“NOT AVAILABLE” DISPLAY (NO FUNCTION DISPLAY)</b>	If a function is not available in the indoor unit even if the button is pressed, “NOT AVAILABLE” is may be displayed for a few seconds.
	<b>“  ” DISPLAY (FAN DIRECTION SWING DISPLAY)</b>	This displays whether the fan direction is fixed or set to swing.
19	<b>“  ” “  ” “  ” “  ” “  ” “  ” “ FRESH UP ” DISPLAY (VENTILATION STRENGTH/SET FAN STRENGTH DISPLAY)</b>	This displays the set fan strength.
	<b>“  No. ” DISPLAY (TIME NO.)</b>	Displays the operation timer No. when used in conjunction with the schedule timer.

21	<p><b>“CODE UNIT No. 18” DISPLAY (OPERATION CODE AND UNIT NUMBER DISPLAY)</b></p> <p>The method of operation (remote controller prohibited, central operation priority after-press operation priority, etc.) is displayed by the corresponding code. This displays the numbers of any indoor units which have stopped due to an error.</p>
	<p><b>“” “” DISPLAY (TIME TO CLEAN AIR CLEANER ELEMENT/ TIME TO CLEAN AIR FILTER)</b></p> <p>Displayed to notify the user it is time to clean the air filter or air cleaner element of the group displayed.</p>
23	<p><b>VENTILATION MODE BUTTON</b></p> <p>This is pressed to switch the ventilation mode of the total enthalpy heat exchanger.</p>
24	<p><b>ALL/INDIVIDUAL BUTTON</b></p> <p>Pressing this button scrolls through the “all screen”, “zone screen”, and “individual screen”.</p>
25	<p><b>ARROW KEY BUTTON</b></p> <p>This button is pressed when calling an individual indoor unit or a zone.</p>
26	<p><b>ON/OFF BUTTON</b></p> <p>Starts and stops ALL, ZONE, and INDIVIDUAL units.</p>
27	<p><b>TEMPERATURE ADJUSTMENT BUTTON (ZONE NUMBER BUTTON)</b></p> <p>This button is pressed when setting the temperature. Select the zone number if any zones have been registered.</p>
	<p><b>FAN DIRECTION ADJUSTMENT BUTTON</b></p> <p>This button is pressed when setting the fan direction to “fixed” or “swing”.</p>
29	<p><b>OPERATION MODE SELECTOR BUTTON</b></p> <p>This sets the operation mode. The dry setting cannot be done.</p>
30	<p><b>TIME NO. BUTTON</b></p> <p>Selects time No. (Use in conjunction with the schedule timer only).</p>
31	<p><b>CONTROL MODE BUTTON</b></p> <p>Selects control mode.</p>
32	<p><b>FILTER SIGN RESET BUTTON</b></p> <p>This button is pressed to erase the “clean filter” display after cleaning or replacement.</p>

33	<p><b>SET BUTTON</b></p> <p>Sets control mode and time No.</p>
34	<p><b>FAN STRENGTH ADJUSTMENT BUTTON</b></p> <p>Pressing this button scrolls through “weak”, “strong”, and “fast”.</p>
	<p><b>ZONE SETTING BUTTON</b></p> <p>Zone registration mode can be turned on and off by pressing the start and stop buttons simultaneously for at least four seconds.</p>
36	<p><b>INSPECTION/TEST RUN BUTTON (FOR SERVICE)</b></p> <p>Pressing this button scrolls through “inspection”, “test run”, and “system display”. This button is not normally used.</p>
37	<p><b>VENTILATION STRENGTH ADJUSTMENT BUTTON</b></p> <p>This button is pressed to switch the ventilation strength (“fresh up”) of the total enthalpy heat exchanger.</p>

(Notes)

1. Please note that all the displays in the figure appear for explanation purposes or when the cover is open.
2. If the unit is used in conjunction with other optional central controllers, the OPERATION LAMP of the unit that is not under operation control may light up and go out a few minutes behind schedule. This shows that the signal is being exchanged, and does not indicate any failure.

**OPERATION**

■ Individual screen, all screen, zone screen (Fig. 3)

This controller can perform operations in the individual screen, all screen, or zone screen.

- Individual screen The individual screen is used when performing group operations.
- All screen The all screen is used when performing operations for all units at once.
- Zone screen The zone screen is used when performing zone operations.

1.  Select the screen by pressing the “ALL/INDIVIDUAL” button.

 Every time the “ALL/INDIVIDUAL” button is pressed, the selection scrolls through INDIVIDUAL → ALL → ZONE.

If nothing is done in the all or zone screens for one minute, it automatically goes to the individual screen.

- If the zone number in the zone screen is displayed as “--,” this indicates that no units are registered in a zone.  
Please perform zone registration before proceeding in the zone screen. (See page 9)

**■ Batch operation and stop method (Fig. 4)**

This is for operating or stopping all connected units at once.

**A. What to do when operating or stopping all connected units at once.**

1. Press either “ALL |” or “ALL ○”.

- Operation can be performed from the individual screen, the all screen, or the zone screen.
- The “TEMPERATURE ADJUSTMENT” and “OPERATION MODE SELECTOR” buttons cannot be used.  
To set the temperature and operation mode, use B. batch operation.

**B. Batch Operation**

1. Press the “ALL/INDIVIDUAL button” to enter the all screen.

The display lights up on all registered units.

2. Press the “SELECT” button.

The display lights up on all connected units.

- Press the “RESET” button.

The display goes off on all connected units. Operation and stop in the batch screen are done the same as with the batch operation and batch stop buttons.

3. Press the “TEMPERATURE ADJUSTMENT” button.

The temperature rises 1° every time the button is pressed.  
The temperature drops 1° every time the button is pressed.

Set to “--” when you do not wish to use batch setting for the temperature setting.  
Setting to 1° above or below the temperature setting range displays “--”.

4. Call up the desired mode by pressing the “OPERATION MODE SELECTOR” button.

Set to “--” when you do not wish to use batch setting for the operation setting.

**■ Group operation and stop method (Fig. 5)**

This is for operating or stopping connected units in groups.

**[Group operation]**

1. Press the “ALL/INDIVIDUAL button” to enter the individual screen.

The unit will enter the individual screen automatically if nothing is done for one minute.

2. Using the arrow keys, move the to select the units to operate or stop.

Keeping the button pressed down will move it rapidly.

The in this screen has selected unit 1-04.

3. Press the “SELECT” button.

The display lights up in the group.

- Press the “RESET” button.

The display goes off in the group.

4. Press the “TEMPERATURE ADJUSTMENT” button.

The temperature rises 1° every time the button is pressed.

The temperature drops 1° every time the button is pressed.

Temperature adjustment cannot be done if the selected group’s air conditioners are in fan mode.

5. Call up the desired mode by pressing the “OPERATION MODE SELECTOR” button.

**■ Registering zones (Fig. 6)**

It is possible to set multiple groups as one zone and control each zone separately.  
No zones are registered when the unit is shipped from the factory.  
Zone registration can be done in the individual screen, all screen, or zone screen.

**[Registration]**

1. Pressing the “ALL/INDIVIDUAL” button for four seconds. Displays ZONE SET.

Zone Number 1 will be displayed, and if there are any groups already registered in the displayed zone, a will light up on the operation monitor.

2. Select the Zone Number to be registered using the “ZONE NUMBER” button. Keeping the button pressed down will move it rapidly.
3. “” to the group you wish to register using the arrow keys. Keeping the button pressed down will move it rapidly.
4. Press the “SELECT” button to register that group to the zone.  
The “” display lights up on all the selected units.  
 Pressing the “RESET” button removes the group from that zone, and “” goes off.

Repeat steps 3 and 4 until all the units you wish to register to the zone have been added.

	ZONE SET					ZONE										
	00	01	02	03	04	05	06	07	08	09	10	11	12	13	14	15
1-																
2-																
3-																
4-																

In this example, a screen is shown with units 1-00, 1-02, 1-03, and 2-00 registered to Zone Number 1.

5. Repeat steps 2 to 4 to register to the next zone.
6. Once zone registration is complete, press the “ALL/INDIVIDUAL” button to turn off “ZONE SET” display and return to the individual screen.

The display returns to the normal screen if nothing is done for one minute when in zone registration mode.

(NOTE)

- It is impossible to register one group to several different zones.  
If this is done, the last zone registered to will be valid.

[Batch deletion of zone registration]

1. Pressing the “ALL ○” for at least four seconds while pressing the “FILTER SIGN RESET” button when “ZONE SET” is displayed will delete all zone registrations.  
The zone registrations for all units will be lost.

■ Zone operation and stop method (Fig. 7)

This is for operating or stopping connected units in zones.

[Zone operation]

1. Press the “ALL/INDIVIDUAL button” to enter the zone screen.
2. Using the arrow keys, select the zone number to operate or stop.

Pressing and reduces the zone number while and raise the number. Keeping the button pressed down will move it rapidly.

- If the zone number is displayed as “--,” this indicates that no units are registered in a zone. Please perform zone registration before using a zone. (See page 9)

3. Press the “SELECT” button.

The “” display lights up in the group.

4. Press the “RESET” button.

The “” display goes off in the group.

4. Press the “TEMPERATURE ADJUSTMENT” button.

The temperature rises 1° every time the (▲) button is pressed.

The temperature drops 1° every time the (▼) button is pressed.

Set to “--” when you do not wish to use zone setting for the temperature setting.

Setting to 1° above or below the temperature setting range displays “--”.

5. Call up the desired mode by pressing the “OPERATION MODE SELECTOR” button.

Set to “--” when you do not wish to use zone setting for the operation mode.

**■ Changing the fan direction and fan strength (Fig. 8)**

This changes the fan direction and strength settings in the air conditioner. Changing the fan direction and strength is done in the individual screen.

**[Registration]**

1. Press the “ALL/INDIVIDUAL button” to enter the individual screen. The unit will enter the individual screen automatically if nothing is done for one minute.
2. Using the arrow keys, move the “” to select the units to fan direction adjustment or fan strength adjustment. Keeping the button pressed down will move it rapidly.
3. Press the “FAN DIRECTION ADJUSTMENT” button. This sets “fixed” or “swing” for the fan direction. Press the “FAN STRENGTH ADJUSTMENT” button. Pressing this button scrolls through “”, “”, and “”. Depending on the indoor unit, only “” and “” may be available.

The functions included in the indoor units may vary. Pressing a button for a function which is not available will cause “NOT AVAILABLE” to be displayed.

**■ Changing the ventilation mode and ventilation strength (Fig. 9)**

This changes the ventilation mode and strength settings in the total enthalpy heat exchanger. Changing the ventilation mode and strength is done in the individual screen.

**[Registration]**

1. Press the “ALL/INDIVIDUAL button” to enter the individual screen. The unit will enter the individual screen automatically if nothing is done for one minute.
2. Using the arrow keys, move the “” to select the units to ventilation mode or ventilation strength adjustment. Keeping the button pressed down will move it rapidly.

3. Press the “VENTILATION MODE” button.

It will scroll through “” → “” → “” → “”.

Press the “VENTILATION STRENGTH ADJUSTMENT” button.

It will scroll through “” → “” → “” → “” → “”.

The fresh up function may not be available depending on the connected unit model. The functions included in the indoor units may vary. Pressing a button for a function which is not available will cause “NOT AVAILABLE” to be displayed.

• **Ventilation Mode and Amount**

If these are changed using the remote controller depending on the unit model, they cannot be displayed on the central remote controller. To monitor the ventilation mode and amount, check the values on the remote controller.

**■ Timer Number Setting (Fig. 10)**

(Only when used with the schedule timer) Using this together with the schedule timer makes it possible to set on and off times four times a day.

**[Registration]**

1. Pressing the “TIMER NO.” button causes the number set for timer number 1 to blink.

If no timer setting has been made “-” will be displayed. Select the desired timer number by pressing the “TIMER NO.” button.

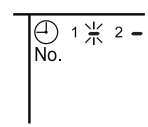

2. Once the desired timer number is displayed, press the “SET” button.

Press the “SET” button within 10 seconds after the timer number is displayed. The display will return to how it was after 10 seconds.

The display for timer number 1 will stop blinking and then timer number 2 will start blinking.

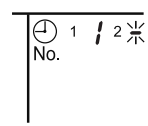

**3.  Select the desired timer number by pressing the “TIMER NO.” button.**

Once the desired timer number is displayed,  press the “SET” button.

The display for timer number 2 will stop blinking.

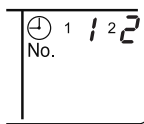

The “ No.” display will disappear after 3 seconds.

Select “-” in the timer number when you do not wish to set a timer number.  
It is possible to set only one timer number.  
(The times for turning the unit(s) on and off twice a day can be set with a single timer number.)

**• Timer Number Setting**

- Group control: select the unit in the individual screen and set the timer number.
- Batch control: set the timer numbers for all connected units.
- Zone control: set the timer numbers for all zone-registered units.  
Call up the zones which you wish to set in the zone screen and set the timer numbers.

**• Since the timer number will be set to after-press priority, the timer number in the last screen set will be valid for the connected units.**

**Example 1**  
Setting timer number 1 for unit 1-00 to “1” and timer number 2 to “2” in the individual screen and then setting timer number 1 to “3” and timer number 2 to “4” in the batch screen causes the timer numbers for all units to be set, so timer number 1 for unit 1-00 will be “3” and timer number 2 will be “4”.

**Example 2**  
To prevent leaving units on, timer number 1 is set to “5” in the batch screen.  
Setting timer number 1 in zone number 1 to “-” in the zone screen after that will change the timer number for zone number 1, so the setting to prevent leaving the units on will be lost for zone number 1 only.

If a timer number is set incorrectly by accident, redo the setting in the desired screen.

**• What happens when the timer number on time and off time are set to the same time**

When the on time and off time are set to the same time for the same timer number, operation does not change.  
When the on time and off time are set to the same time for different timer numbers, the off time is given priority.

When using timer operation, make sure the times do not overlap when setting the program of the schedule timer.

**■ Setting the Operation Code (Fig. 11)**

**[Registration]**

**1.  Pressing the “CONTROL MODE” button causes the currently set operation code to blink.**

Call up the desired code number by pressing the  “CONTROL MODE” button.  
Scroll through the code numbers.

**2.  Once the code number is displayed, press the “SET” button.**

The display will stop blinking.  
The operation code display will disappear after 3 seconds.

**[The Operation Code Setting]**

- Group control: select the unit in the individual screen and set the operation code.
- Batch control: set the operation code for all connected units.
- Zone control: set the operation code for all zone-registered units.  
Call up the zones which you wish to set in the zone screen and set the operation code.

Since the operation code will be set for after-press priority, setting the operation code in the zone and individual screens after setting the operation code in the batch screen, will cause the operation codes set afterwards to be valid.

## OPERATION MODE

The following five operation control modes can be selected along with the temperature setting and operation mode by remote controller, for a total of twenty different modes. These twenty modes are set and displayed with control modes of 0 to 19. (For further details, see **EXAMPLE OF OPERATION SCHEDULE** on the next page.)

- ON/OFF control impossible by remote controller..... Use this mode when operating and stopping from the central remote controller only. (ON/OFF control by the remote controller is disabled.)
- Only OFF control possible by remote controller ..... Use this mode when executing the operation only by the central remote controller, and executing only the stop by remote controller.
- Centralized ..... Use this mode when executing the operation only by the central remote controller, and executing start/stop freely by remote controller during the preset hours.
- Individual ..... Use this mode when executing start/stop both by central remote controller and remote controller.
- Timer operation possible by remote controller..... Use this mode when executing start/stop by remote controller during the preset hours, and not starting operation by the central remote controller at the programmed time of system start.

### [HOW TO SELECT THE CONTROL MODE]

- Select whether to accept or to reject the operation from the remote controller regarding the operation, stop, temperature setting and operation mode setting, respectively, and determine the particular control mode from the rightmost column of the table below.

Example

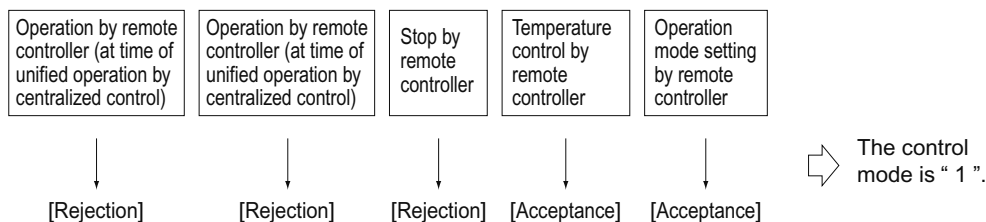



Operation mode	Control by remote controller					Control mode
	Operation		Stop	Temperature control	Operation mode setting	
	Unified operation, individual operation by central remote controller, or operation controlled by timer	Unified stop, individual stop by central remote controller, or timer stop				
ON/OFF control impossible by remote controller	Rejection (Example)	Rejection (Example)	Rejection (Example)	Rejection	Acceptance	0
Only OFF control possible by remote controller				Acceptance (Example)	Acceptance (Example)	1 (Example)
Centralized	Acceptance	Acceptance	Acceptance	Rejection	Acceptance	2
Individual				Rejection	Rejection	12
				Acceptance	Acceptance	3
Timer operation possible by remote controller				Acceptance (During timer at ON position only)	Rejection (During timer at OFF position)	Rejection
			Rejection	Acceptance	Acceptance	4
			Acceptance	Rejection	Rejection	14
			Acceptance	Acceptance	Acceptance	5
			Rejection	Acceptance	Rejection	15
			Acceptance	Rejection	Acceptance	6
			Rejection	Acceptance	Rejection	16
			Acceptance	Rejection	Acceptance	7
			Rejection	Acceptance	Rejection	17
			Acceptance	Rejection	Acceptance	8
			Rejection	Acceptance	Rejection	18
			Acceptance	Rejection	Acceptance	9
			Rejection	Acceptance	Rejection	19

Note) Do not select the timer operation possible without the remote controller. In this case, timer operation is disabled.

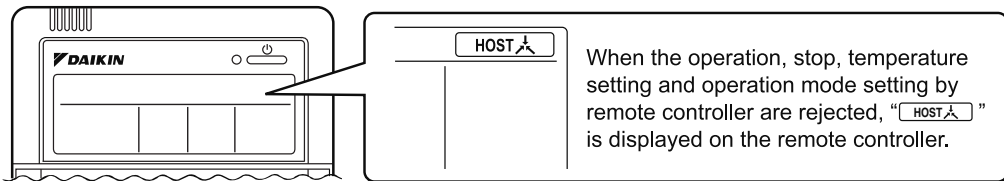

**EXAMPLE OF OPERATION SCHEDULE**

Operation schedule is possible only in conjunction with the schedule timer (optional accessory).

**Liquid crystal display of schedule timer**

ON/OFF control impossible by remote controller

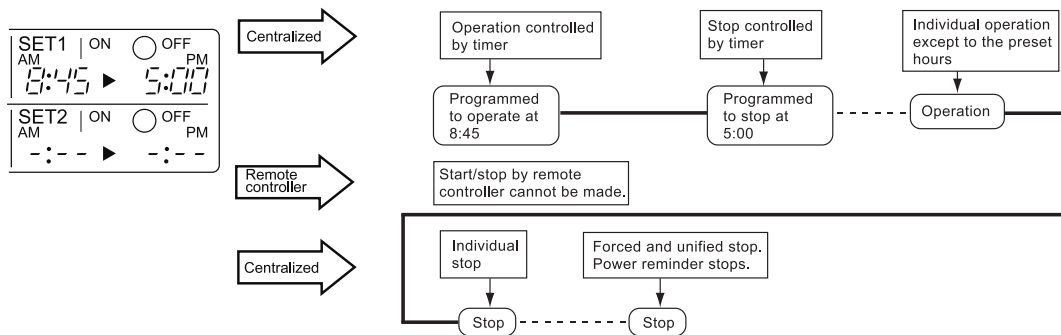



Only OFF control possible by remote controller

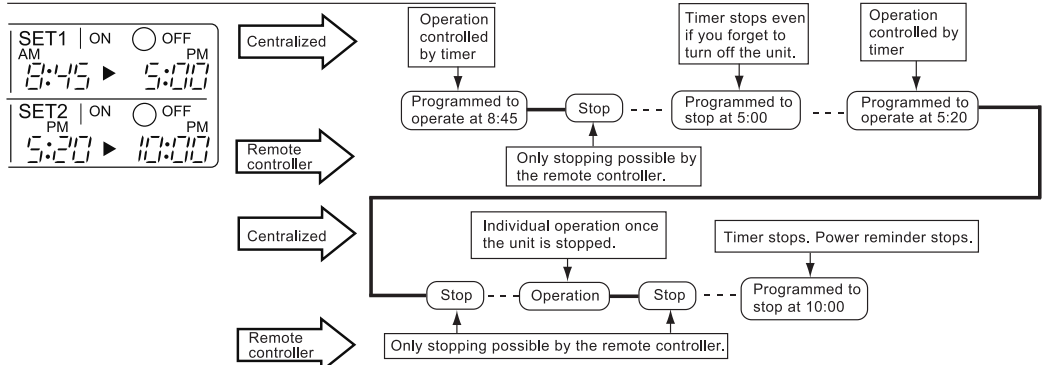

Centralized

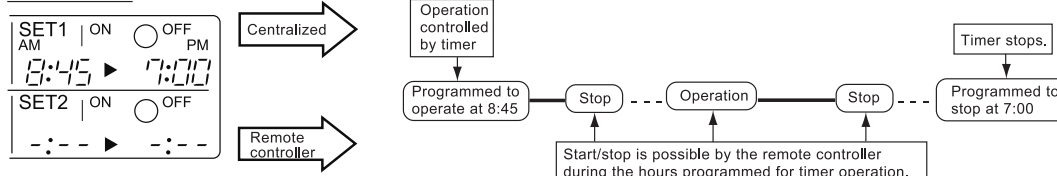

Individual

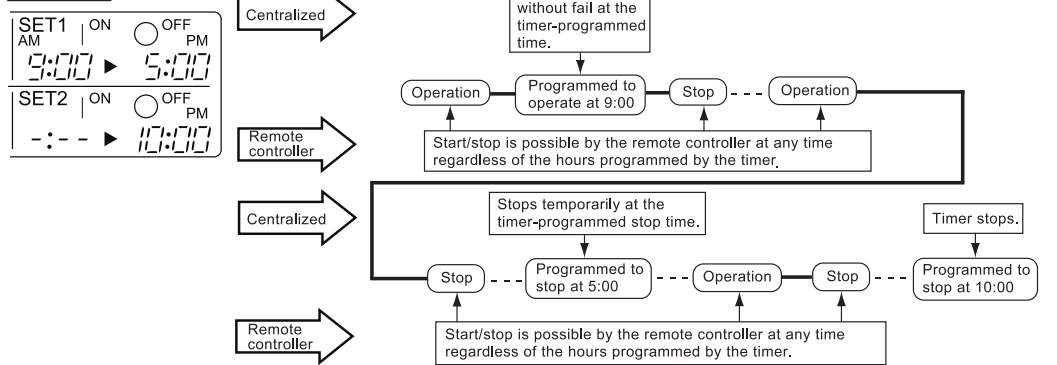

Timer operation possible by remote controller

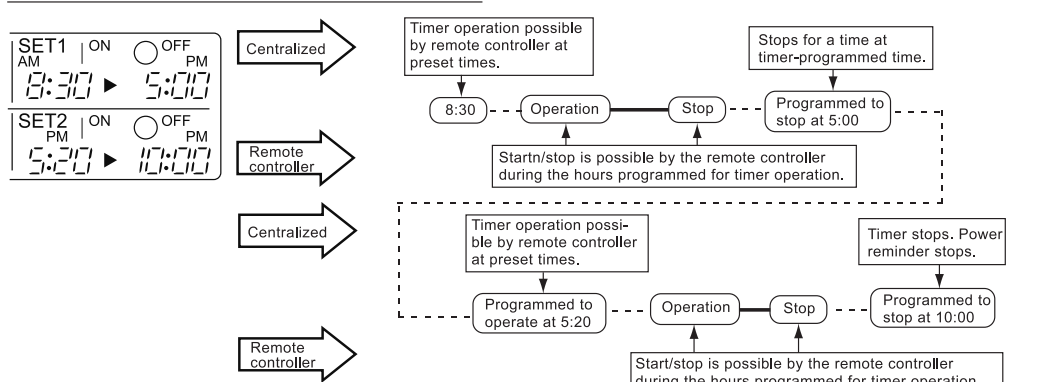

- Air conditioner now operating.
- - - - Air conditioner now stopping.
- ▭ Command by central remote controller
- Command by remote controller

■ Setting operation mode (Fig. 12)

[Registration]

1. Press the OPERATION MODE SELECTOR BUTTON. Each time you press this button, the display rotates as shown on the below list.

- List of operations which can be set  
In the below list, “○” refers to the acceptable setting, while “×” refers to the not acceptable setting.

Display	A: Zones and groups with no “ ” display.	
	Setting	Contents of setting
	×	
	○	Can be set in individual zones or groups
	○ * 1	Can be set in individual zones or groups
	○	Can be set in individual zones or groups
	○	Can be set in individual zones or groups
	○ * 1	Can be set in individual zones or groups * 3
	○ * 1	Can be set in individual zones or groups
	○	Select this display if you don't wish to set by zone.

Display	B: Zones and groups with a “ ” display.	
	Setting	Contents of setting
	○	To be set by zone * 2
	○	Can be set in individual zones or groups
	×	
	×	The displays are shown by group * 4
	×	The displays are shown by group * 4
	○ * 1	Can be set in individual zones or groups * 3
	○ * 1	Can be set in individual zones or groups
	○	Select this display if you don't wish to set by zone.

- \*1: Setting may not be acceptable depending on the type of indoor unit with which this unit is connected.
- \*2: In zone control, the units run in temperature adjustment mode (heating or cooling) for the outdoor system for the groups registered to those zones. Heating or cooling selection is not available.
- \*3: or or Changing the ventilation mode cannot be done in the zone screen. Changing the ventilation mode should be done in the individual screen.
- \*4: In group control, the units run in temperature adjustment mode (heating or cooling) for the group outdoor system. Heating or cooling selection is not available.

• The Zone consists of the following two cases.

**A. Zone without display“ ”**  
The group with master remote controller setting exists in this zone. Setting the master remote controller enables cool/heat selection. Operations other than cool/heat operations can also be set for some operations. For further details, see the list on the left.

**B. Zone with display“ ”**  
No group with master remote controller setting exists in this zone. The cool/heat selection is not available because the master remote controller has not been set. Some operations other than cool/heat operations can be set. For further details, see the list in the left.

See page 20 if the display“ ” is flashing.

- Fan operation can be performed for each zone using the central remote controller even if there is no cooling/heating selection right during cooling or heating. Also, if a VentiAir is connected in the zone, ventilation and ventilation cleaning operation is possible. See the included operating manuals for details.
- When the indoor unit is in heat operation, change the setting to FAN operation through the central remote controller; then, you can switch the fan speed to the extremely low fan speed. Warm air may blow if any other indoor unit belonging to the same system is in heat operation.
- The indoor fan stops during defrost/hot start.
- DRY cannot be set from the central remote controller.

■ Group monitoring (Fig. 13)

Utilize the group monitor function in each of the following cases:

1. Check the malfunction code. (See the next page.)
2. Check the group that requires cleaning of the air filter and air cleaner element. (See page 21.)
3. Change the setting of the master remote controller. (See page 20.)
4. Check the group(s) sharing the same outdoor unit. Or, check the particular group(s) with the master remote controller setting. (See page 20.)
5. Check the conditions of other individual groups.

**When in zone screen**

The zone screen will revert to the individual screen automatically if nothing is done in it for one minute.

**[Registration]**

1. Press the “ALL/INDIVIDUAL” button to switch to the “INDIVIDUAL” screen.

2. Using the arrow key, move the “ ” to select the unit to be monitored.

Keeping the button pressed down will move it rapidly.

The “ ” lights up and the status of that unit is displayed in the LCD. The cursor in the screen Fig. 13 has selected unit 2-06.

**■ Error diagnosing function (Fig. 14)**

This central remote controller is provided with a diagnosing function, for when an indoor unit stops due to malfunction. In case of actuation of a safety device, disconnection in transmission wiring for control or failure of some parts, the operation lamp, inspection display and unit No. start to flash; then, the malfunction

code is displayed. Check the contents of the display, and contact your DAIKIN dealer because the above signs can give you the idea on the trouble area.

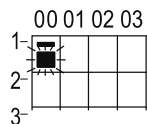

The display “ ” flashes under the group No. where the indoor unit that has stopped due to malfunction.

**[Registration]**

1. Press the ARROW KEY BUTTON to call up the group that has stopped due to malfunction.

The unit No. the malfunction code is flashing because of an error failure.

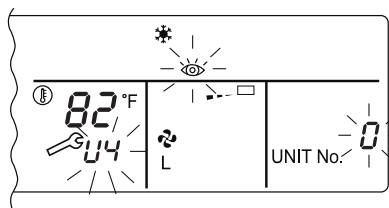

Operation lamp	Maintenance display	Unit No.	Malfunction code	Error content
☀	●	⚡	64	Indoor air thermistor error
☀	●	⚡	65	Outdoor air thermistor error
☀	●	⚡	68	HVU error (Venti-air dust-collecting unit)
☀	●	⚡	6A	Dumper system error
⚡	⚡	⚡	6A	Dumper system error + Thermistor error
☀	●	⚡	6F	Simple remote controller error
☀	●	⚡	6H	Door switch (Venti-air dust-collecting unit), relay harness fault (Venti-air dust-collecting/humidifier unit)
⚡	⚡	⚡	94	Venti-air internal transmission error (between total enthalpy – fan unit)
⚡	⚡	⚡	A0	Indoor unit · external safety device error
⚡	⚡	⚡	A1	Indoor unit · BEV unit (Sky-Air connection unit) PC board assembly fault
☀	●	⚡	A1	Indoor unit · PC board assembly fault
⚡	⚡	⚡	A3	Indoor unit · Drain level error (33H)
⚡	⚡	⚡	A6	Indoor unit · Fan motor (51F) lock, overload
☀	●	⚡	A7	Indoor unit · Fan direction adjustment motor (MA) error
⚡	⚡	⚡	A9	Indoor unit · BEV unit, electric expansion valve motor (20E) error
☀	●	⚡	AF	Indoor unit · Malfunctioning drain
☀	●	⚡	AH	Indoor unit · Dust-collector error
⚡	⚡	⚡	AJ	Indoor unit · Insufficient capacity setting, address setting fault

☼	☼	☼	C4	Indoor unit · Liquid piping thermistor (Th2) Error (faulty connection, cut wire, short circuit, fault)
☼	☼	☼	C5	Indoor unit · BEV unit, gas piping thermistor (Th3) Error (faulty connection, cut wire, short circuit, fault)
☼	☼	☼	C9	Indoor unit · Intake air thermistor (Th1) Error (faulty connection, cut wire, short circuit, fault)
☼	☼	☼	CA	Indoor unit · Outlet air thermistor (Th4) Error (faulty connection, cut wire, short circuit, fault)
☼	●	☼	<b>CJ</b>	Indoor unit · remote controller sensor error
☼	☼	☼	E0	Outdoor unit · Safety device operation
☼	☼	☼	E1	Outdoor unit · PC board assembly fault
☼	●	☼	<b>E1</b>	Outdoor unit · PC board assembly fault
☼	☼	☼	E3	Outdoor unit · High-pressure switch fault
☼	☼	☼	E4	Outdoor unit · Low-pressure switch fault
☼	☼	☼	E9	Outdoor unit · Electric expansion valve motor (20E) error
☼	●	☼	<b>EC</b>	Heat source unit · Intake water temperature inter-lock operation (fan operation)
☼	☼	☼	EF	Outdoor unit · Ice thermal storage unit error
☼	☼	☼	F3	Outdoor unit · Discharge piping temperature error
☼	●	☼	<b>H3</b>	Outdoor unit · High-pressure switch operation
☼	☼	☼	H4	Outdoor unit · Low-pressure switch operation
☼	☼	☼	H9	Outdoor unit · Outdoor air thermistor (Th1) Error (faulty connection, cut wire, short circuit, fault)
☼	●	☼	<b>H9</b>	Outdoor unit · Outdoor air thermistor (Th1) Error (faulty connection, cut wire, short circuit, fault)
☼	●	☼	<b>HC</b>	Outdoor unit · Water temperature sensor system error
☼	●	☼	<b>HF</b>	Ice thermal storage unit error, ice thermal storage controller error, error in outdoor unit during ice thermal storage operation
☼	☼	☼	HJ	Outdoor unit · water system fault
☼	☼	☼	J1	Outdoor unit · pressure sensor error
☼	☼	☼	J3	Outdoor unit · Discharge piping thermistor (Th3) Error (faulty connection, cut wire, short circuit, fault)
☼	●	☼	<b>J3</b>	Outdoor unit · Discharge piping thermistor (Th3) Error (faulty connection, cut wire, short circuit, fault)
☼	☼	☼	J5	Outdoor unit · Intake piping thermistor (Th4) Error (faulty connection, cut wire, short circuit, fault)
☼	☼	☼	J6	Outdoor unit · Heat exchange thermistor (Th2) error
☼	●	☼	<b>J6</b>	Outdoor unit · Heat exchange thermistor (Th2) error Error (faulty connection, cut wire, short circuit, fault)
☼	☼	☼	J7	Outdoor unit · Header thermistor (Th6) error
☼	☼	☼	JA	Outdoor unit · Discharge piping pressure sensor error
☼	☼	☼	JC	Outdoor unit · Intake piping pressure sensor error
☼	☼	☼	JF	Outdoor unit · Oil temperature sensor (Th5) system error
☼	●	☼	<b>JH</b>	Outdoor unit · Oil temperature sensor (Th5) system error
☼	☼	☼	L0	Outdoor unit · Inverter system fault
☼	☼	☼	L4	Outdoor unit · Inverter cooler fault
☼	☼	☼	L5	Outdoor unit · Ground circuit for compressor motor, short circuit, or power unit short circuit

☼	☼	☼	L6	Outdoor unit · Ground circuit for compressor motor, short circuit
☼	☼	☼	L8	Outdoor unit · Compressor overload, compressor motor wire disconnection
☼	☼	☼	L9	Outdoor unit · Compressor lock
☼	☼	☼	LA	Outdoor unit · Power unit error
☼	☼	☼	LC	Outdoor unit · Transmission error between inverter and outdoor control unit
☼ or ●	☼	☼	M1	Central controller: PC board fault
☼ or ●	☼	☼	M8	Transmission error between central controllers
☼ or ●	☼	☼	MA	Central controller: Incorrect combination
☼ or ●	☼	☼	MC	Central controller: Address setting fault
☼	●	☼	<b>P0</b>	Insufficient gas (thermal storage)
☼	☼	☼	P1	Outdoor unit · Power voltage imbalance, phase loss
☼	☼	☼	P4	Outdoor unit · Power unit temperature sensor error
☼	●	☼	<b>U0</b>	Pressure drop due to insufficient refrigerant, electric expansion valve fault, etc.
☼	☼	☼	U1	Reversed or lost phase
☼	☼	☼	U2	Power voltage error, momentary electrical stoppage
☼	☼	☼	U4	Transmission error between indoor unit/BEV unit and outdoor/BS unit, Transmission error between outdoor unit and BS unit
☼	☼	☼	U5	Transmission error between remote controller and indoor control unit
●	☼	●	U5	Remote controller board fault or remote controller setting fault
☼	☼	☼	U6	Transmission error between indoor units
☼	☼	☼	U7	Transmission error between outdoor units Transmission error between outdoor unit and ice thermal storage unit
☼	●	☼	<b>U7</b>	Transmission error between outdoor units (cooling/heating batch, low-noise operation)
☼	☼	●	U8	Transmission error between master remote controller and slave remote controller (slave remote controller error) Incorrect combination of indoor unit and remote controller within a single system (model)
☼	☼	☼	U9	Transmission error between indoor unit/BEV unit and outdoor unit within a single system Transmission error between BS unit and indoor unit/BEV unit and outdoor unit within a single system
☼	☼	☼	UA	Incorrect combination of indoor, BS, and outdoor units within a single system (model, number of units, etc.) Incorrect combination of indoor unit and remote controller (remote controller in question) BS unit connection position fault
☼	●	☼	<b>UC</b>	Central control group numbers overlap
☼	☼	☼	UE	Transmission error between indoor unit and central controller
☼	☼	☼	UF	Unset system, incorrect settings between BEV unit and indoor unit
☼	☼	☼	UH	System fault

■ error codes (in outline font) do not display “maintenance” and the system will run, but please check the content of the display and contact your dealer.

**■ Setting master remote controller (Fig. 15)**

You must set the master remote controller of the operation mode for one of the indoor units, if two or more such indoor units with the remote controller are connected with the outdoor unit where the operation modes such as cool/heat operation and FAN operation can be set by remote controller and central remote controller.

**1. Preparations**

**When you want to fix settings**

- Check the particular group with the master remote controller setting for the refrigerant system you wish to reset. (See the below.)
- Call up the group without the display “” (See page 16.)

➡ Hold the OPERATION MODE SELECTOR BUTTON down for about four seconds while the above group is being called up.

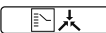
The display “” flashes on the liquid crystal display of the remote controller for all the groups sharing the same outdoor unit or BS unit.

When you turn on the power switch for the first time, the display “” flashes.

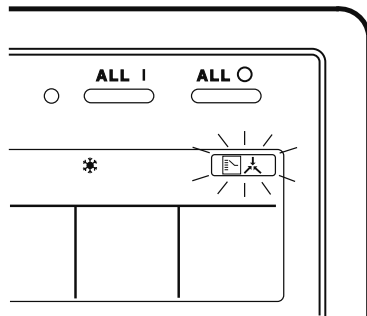

**2. Setting selection right**

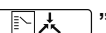
Pull up the desired group to set the master remote controller, and ➡ press the OPERATION MODE SELECTOR BUTTON. The master remote controller is set for this group, and the display “” goes out. The display “” appears for the other groups. Setting is finished now.



**When switching operation**

**● In case of operation switch**



**Call up the zone including the group with the setting of master remote controller.**

**(Zone without the display “”)**

➡ Press the OPERATION MODE SELECTOR BUTTON several times, and switch to the desired operation mode.

Each time you press it, the display is switched to “” “” “” and “--” in sequence.

**NOTE**

- However, the displays “” “” and “VENTILATION MODE” may appear in some zones, depending on the type on indoor unit with which they are connected.

(VENTILATION MODE)



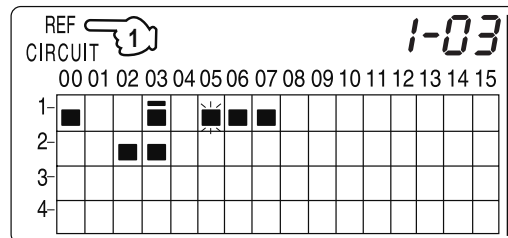

**[System Display]**

1. Test run mode is necessary to display the system display.
2. In order to turn on test run mode, select the appropriate air conditioner on the individual screen with the cursor and then set its operation mode to either cooling or heating. (It makes no difference if the air conditioner is running or not running while this operator is being performed.)
3. Press the “inspection/test run” button twice to put it into test run mode.
4. Pressing the “inspection/test run” button for four or more seconds in test run mode will display ➡ the “REF CIRCUIT.”



Call the unit whose system you wish to look up using the arrow keys.

The “” on all groups in the same system as the displayed group will light up.

Of those, the “” display in all groups which have cooling/heating selection privilege will blink.

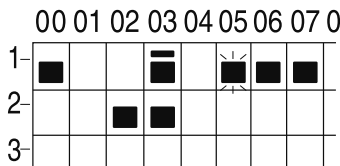

**In this example, individual units 1-00, 1-03, 1-05, 1-06, 1-07, 2-02, and 2-03 are in the same system, and 1-05 has the cooling/heating selection privilege.**

To look up other systems, call up all the units you wish to look up using the arrow keys.

Pressing the inspection/test run button one more time gets rid of the system display and ends it.

The unit will enter the individual screen automatically if nothing is done for one minute in the system display screen.



This function may not be available for all connected outdoor units, in which case “REF CIRCUIT” will blink. It will also not be correctly displayed if DIII-NET extension ADP is used.



**■ Display of time to clean (Fig. 16)**

This central remote controller displays the time to clean the air filter or air cleaner element for each group or any given group by utilizing two types of signs. The display “” tells the time to clean the air filter or the air cleaner element of some group.

**If a cleaning sign is displayed**



A filter or element in some group is ready to be cleaned.

1.  Press the **ARROW KEY BUTTON**, and search the groups displaying “” or “” (The group may be plural.)

**Clean or change the air filter or air cleaner element.**  
 For further details, see the operation manual attached to each indoor unit. (Clean or change the air filter or air cleaner element of all the groups displaying “” or “”.)

2.  Press the **FILTER SIGN RESET BUTTON**, and the display “” disappears. (Including all the groups where the air filter has been cleaned.)

**NOTE**

Be sure to check the display  “” has disappeared at this point. The appearance of the above display is a sign that the air filter or air cleaner element of some group still needs cleaning.







## INSTALLATION TABLE

When installing the equipment, mark the zone No. of each group and installation location in the below table.

### Setting group No.

(Setting is not possible unless power is activated to both the central remote controller and indoor unit.)

### Operated by remote controller

1. Activate power to both the central remote controller and indoor unit.
2. While in the normal mode, hold down the “” button for a minimum of 4 seconds. The unified ON/OFF controller will enter the FIELD SET MODE.
3. Select the MODE No. “” with the “” button.
4. Use the “” button to select the group No. for each group. (Group No. increases in the order of 1-00, 1-01 ... 1-15, 2-00, ... 8-15.)
5. Press “” to set the selected group No.
6. Press “” to return to the NORMAL MODE.

### Operated by simplified remote controller

1. Activate power to both the central remote controller and indoor unit.
2. Remove the upper part of the remote controller.
3. Press the **BS6** BUTTON (field set) on the PC board. The controller will enter the FIELD SET MODE.
4. Select the MODE No. “” with the **BS2** BUTTON and **BS3** BUTTON (temperature setting).
5. Use the **BS9** BUTTON (set A) and **BS10** BUTTON (set B) to select the group No. for each group. (Group No. increases in the order of 1-00, 1-01 ... 1-15, 2-00, ... 8-15.)
6. Press **BS7** BUTTON (set/cancel) to set the selected group No.
7. Press **BS6** BUTTON (field set) to return to the NORMAL MODE.

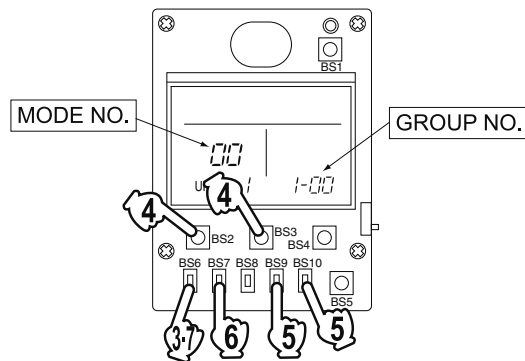
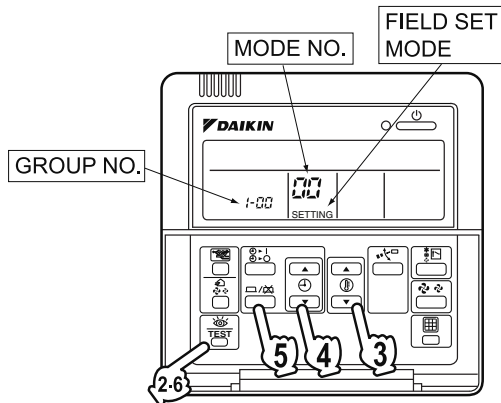

Zone No.																
Group No.	-00	-01	-02	-03	-04	-05	-06	-07	-08	-09	-10	-11	-12	-13	-14	-15
Indoor unit Quantity of units Controlled by																
Location																
Zone No.																
Group No.	-00	-01	-02	-03	-04	-05	-06	-07	-08	-09	-10	-11	-12	-13	-14	-15
Indoor unit Quantity of units Controlled by																
Location																



Zone No.																
Group No.	-00	-01	-02	-03	-04	-05	-06	-07	-08	-09	-10	-11	-12	-13	-14	-15
Indoor unit Quantity of units Controlled by																
Location																
Zone No.																
Group No.	-00	-01	-02	-03	-04	-05	-06	-07	-08	-09	-10	-11	-12	-13	-14	-15
Indoor unit Quantity of units Controlled by																
Location																

**OPTIONAL ACCESSORIES**

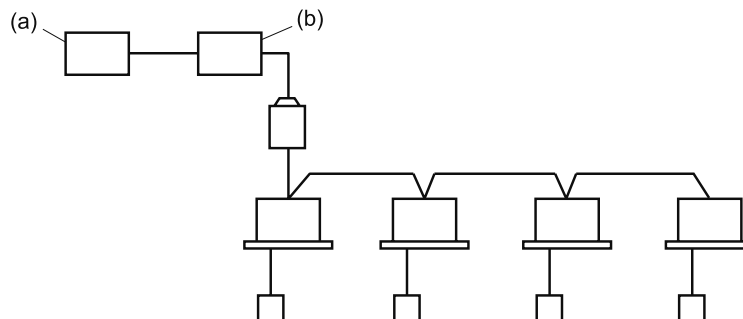

You can perform the normal operation, take off the malfunction contact point and unified start/stop by contact point, all by connecting this unit with the unification adaptor for computerized control. For further details, ask your DAIKIN dealer.

(a) Unification adaptor for computerized control (b) Central remote controller

**DOUBLE CENTRAL REMOTE CONTROLLERS**

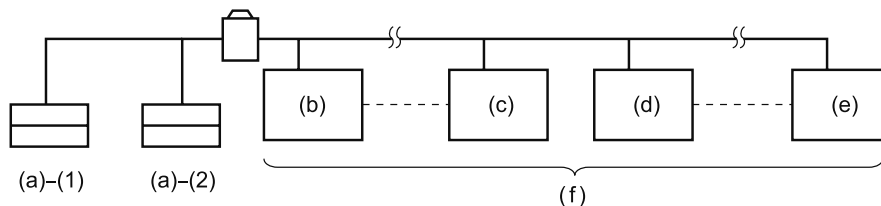

With two central remote controllers, centralized control (indoor units) is possible from different locations.

(a) Central remote controller (b) Group No. 1 - 00 (c) Group No. 1 - 15 (d) Group No. 2 - 00  
 (e) Group No. 4 - 15 (f) A maximum of 64 groups

**Note)**

- For control alignment and settings for double central remote controllers, contact your dealer.

## SPECIFICATIONS

### ■ Specifications

Power supply	1 ~ 50/60Hz, 100V - 240V
Power consumption	Max. 8W
Forced ON/OFF input	Continuous "a" contact Contact current: approximately 10mA
Size	180 (W) × 120 (H) × 64.5 (D)
Weight	420g

### ■ Outline drawings

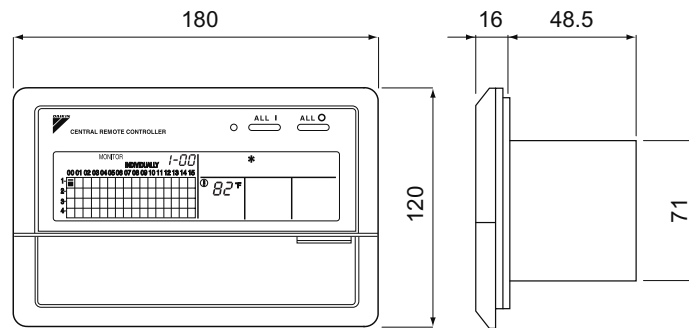

When using this unit an electric parts box of KJB311A is required.  
For installation, a steel electric parts box to be embedded is mandatory.

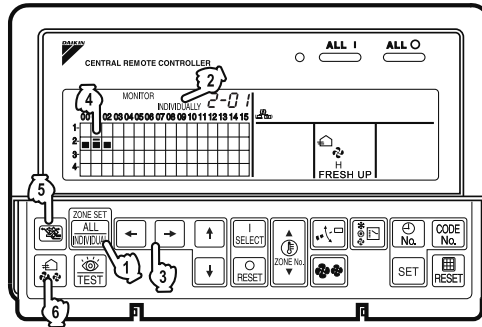

Fig. 9

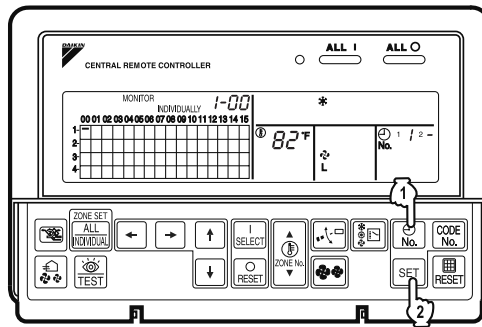

Fig. 10

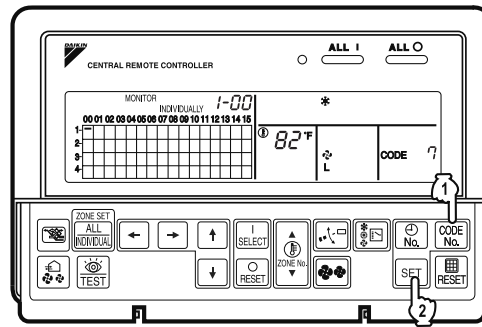

Fig. 11

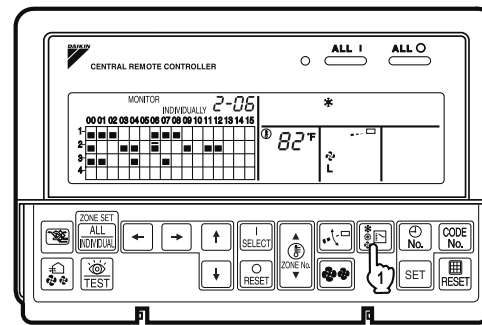

Fig. 12

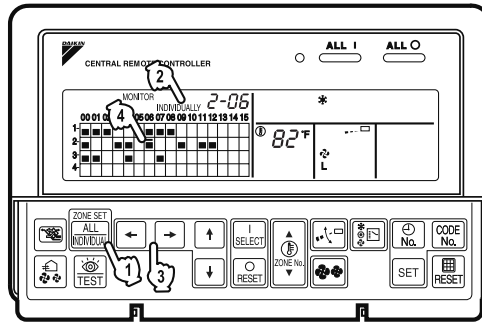

Fig. 13

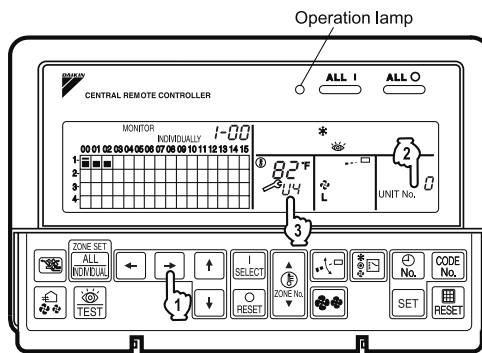

Fig. 14

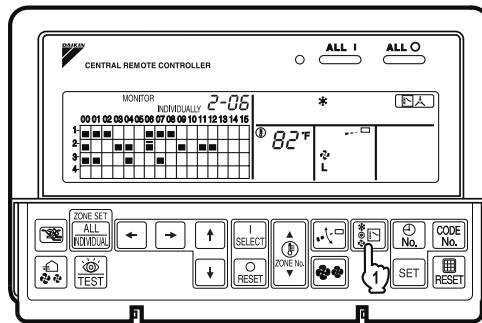

Fig. 15

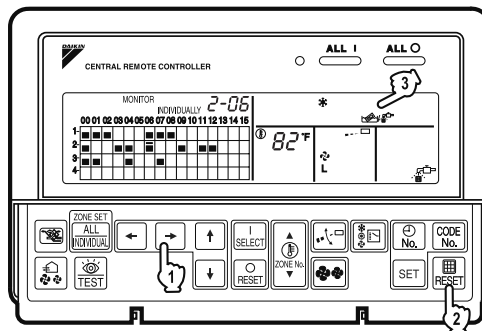





Fig. 16

## 14.11 <DCS301C71> Unified ON/OFF Controller Installation Manual

Please read these "SAFETY CONSIDERATIONS" carefully before installing air conditioning equipment and be sure to install it correctly. After completing the installation, make sure that the unit operates properly during the start-up operation.  
 Please instruct the customer on how to operate the unit and keep it maintained.  
 Also, inform customers that they should store this installation manual along with the operation manual for future reference.  
 This air conditioner comes under the term "appliances not accessible to the general public".

Meaning of warning, caution and note symbols.

-  **WARNING**..... Indication a potentially hazardous situation which, if not avoided, could result in death or serious injury.
-  **CAUTION**.....Indication a potentially hazardous situation which, if not avoided, may result in minor or moderate injury. It may also be used to alert against unsafe practices.
-  **NOTE**.....Indication situation that may result in equipment or property-damage-only accidents.

### **WARNING**

**Ask your dealer or qualified personnel to carry out installation work. Do not try to install the machine by yourself.**  
 Improper installation may result in water leakage, electric shocks or fire.

**Perform installation work in accordance with this installation manual.**  
 Improper installation may result in water leakage, electric shocks or fire.

**Be sure to use only the specified accessories and parts for installation work.**  
 Failure to use the specified parts may result in water leakage, electric shocks, fire or the unit falling.

**Carry out the specified installation work after taking into account strong winds, typhoons or earthquakes.**  
 Improper installation work may result in the equipment falling and causing accidents.

**Make sure that a separate power supply circuit is provided for this unit and that all electrical work is carried out by qualified personnel according to local laws and regulations and this installation manual.**  
 An insufficient power supply capacity or improper electrical construction may lead to electric shocks or fire.

**Make sure that all wiring is secured, the specified wires are used, and no external forces act on the terminal connections or wires.**  
 Improper connections or installation may result in fire.

**When wiring the power supply and connecting the remote controller wiring and transmission wiring, position the wires so that the electric parts box lid can be securely fastened.**  
 Improper positioning of the electric parts box lid may result in electric shocks, fire or the terminals overheating.

**Before touching electrical parts, turn off the unit.**

**Ground the air conditioner. Do not connect the ground wire to gas or water pipes, lightning rod or a telephone ground wire.**  
 Incomplete grounding may result in electric shocks.

**When installing or relocating the system, be sure to keep the refrigerant circuit free from substances other than the specified refrigerant (R410A), such as air.**

**Do not reconstruct or change the settings of the protection devices.**  
 If the pressure switch, thermal switch, or other protection device is shorted and operated forcibly, or parts other than those specified by Daikin are used, fire or explosion may result.

**Do not touch the switch with wet fingers.**  
 Touching a switch with wet fingers can cause electric shock.

**Install a leak circuit breaker, as required.**  
 If a leak circuit breaker is not installed, electric shock may result.

**Do not install the air conditioner or the remote controller in the following locations:**

- (a) where a mineral oil mist or an oil spray or vapor is produced, for example in a kitchen  
 Plastic parts may deteriorate and fall off or result in water leakage.
- (b) where corrosive gas, such as sulfurous acid gas, is produced  
 Corroding copper pipes or soldered parts may result in refrigerant leakage.
- (c) near machinery emitting electromagnetic waves  
 Electromagnetic waves may disturb the operation of the control system and result in a malfunction of the equipment.
- (d) where flammable gases may leak, where there are carbon fiber or ignitable dust suspensions in the air, or where volatile flammables such as thinner or gasoline are handled.  
 Operating the unit in such conditions may result in fire.

### **CAUTION**

**Be very careful about product transportation.**

**Safely dispose of the packing materials.**  
 Packing materials, such as nails and other metal or wooden parts, may cause stabs or other injuries.  
 Tear apart and throw away plastic packaging bags so that children will not play with them. If children play with a plastic bag which was not torn apart, they face the risk of suffocation.

**Do not turn off the power immediately after stopping operation.**  
 Always wait at least five minutes before turning off the power. Otherwise, water leakage and trouble may occur.

### **NOTE**

**Install the indoor and outdoor units, power supply wiring and connecting wires at least 3.5ft. away from televisions or radios in order to prevent image interference or noise.**  
 (Depending on the radio waves, a distance of 3.5ft. may not be sufficient enough to eliminate the noise.)

**Remote controller (wireless kit) transmitting distance can result shorter than expected in rooms with electronic fluorescent lamps. (inverter or rapid start types)**  
 Install the indoor unit as far away from fluorescent lamps as possible.

**This unit is a class A product.**  
 In a domestic environment this product may cause radio interference in which case the user may be required to take adequate measures.

**Dismantling of the unit, treatment of the refrigerant, oil and eventual other parts, should be done in accordance with the relevant local and national regulations.**

# 1 COMPONENTS

Check the following components are included in this optional accessory before installation.

Body

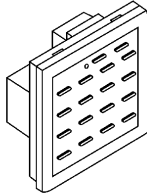

Installation screw (M4 x 16)	2
Operation manual	1
Installation manual	4
Installation table	4
Switch display sticker	1

When using this optional accessory an electric parts box of KJB212A is required. For installation, a steel electric parts box to be embedded is mandatory.

# 2 SYSTEM CONFIGURATION

This unified ON/OFF controller enables individual and unified operation/stop for a maximum of 16 groups of indoor units. With 2 to 8 unified ON/OFF controllers, individual and unified control is possible with up to a maximum 128 groups of indoor units.

- When using 1 unified ON/OFF controller

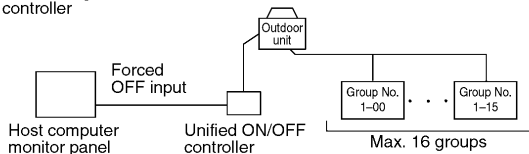

(This optional accessory can not be used in conjunction with wiring adapter for electrical appendices (optional accessory).)

- When using 2 to 8 unified ON/OFF controllers

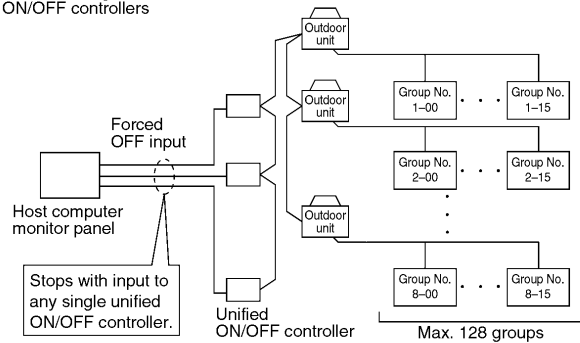

The groups of indoor units are as follows:

- 1 One indoor unit without remote controller

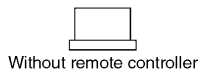

Without remote controller

- 2 One indoor unit controlled by one or two remote controllers

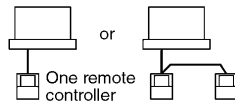

One remote controller or Two remote controllers

- 3 A maximum of 16 indoor units controlled in groups by one or two remote controllers

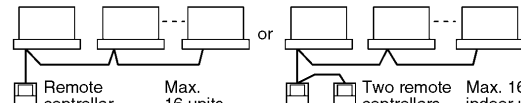

Remote controller Max. 16 units or Two remote controllers Max. 16 indoor units

# 3 INSTALLATION

- 1 Open the upper part of remote controller. Insert a ⊖ screwdriver (2 locations) into the recess between the upper part and the lower part of remote controller and twist the screwdriver lightly.

PC board is attached with both the upper and lower part of remote controller. Do not damage the board with the screwdriver.

- 2 Open the upper part of remote controller and install the electric parts box (part to be procured in the field) with the attached installation screws (M4 x 16).

NOTE) Suitable length of the electric wire is about 160mm from the inlet of the electric parts box. If it is difficult to contain a long wiring, strip the sheathed part of the wiring.

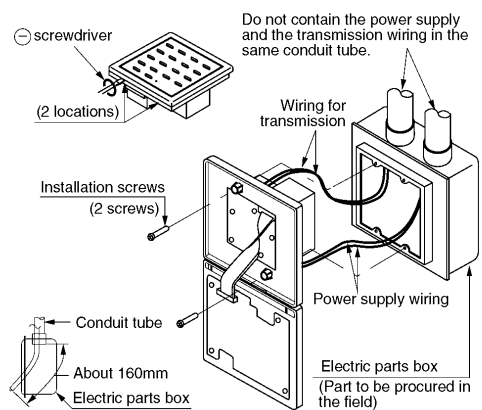

# 4 INITIAL SETTING

Setting ① through ③ are initialized when power is turned ON, therefore complete settings BEFORE activating the power.

- Connector for setting master controller (X1A) (Provided with connector at factory set)
  - When using 1 unified ON/OFF controller, do not disconnect the connector for setting master controller. (Use the unit with the connector in the state in which it was delivered.)
  - When using multiple unified ON/OFF controllers, or using the unified ON/OFF controller in conjunction with other optional controllers for centralized control, makes settings as indicated in the right table.

Pattern of connection of optional controllers for centralized control			Connector for setting master controller (X1A) Settings		
Unified ON/OFF controller	Central remote controller	Schedule timer	Unified ON/OFF controller	Central remote controller	Schedule timer
1 to 16	1 to 4		Set one to "Used" and all the rest to "Not used".		
		1	Set all to "Not used".	(Note)	
	1 to 4	1	Set one to "Used" and all the rest to "Not used".	(Note)	"Not used"
			Set all to "Not used".		"Not used"

(Note) For instructions on how to set the connector for setting master controller on the central remote controller, see the installation manual provided with the central remote controller.

- Switch for setting each address (DS1)  
These switches are used to set group control address.  
Groups Nos. 1-00 through 1-15 are grouped in the same control group when the unit is shipped from the factory.

Each Address	1-00 ~ 1-15	2-00 ~ 2-15	3-00 ~ 3-15	4-00 ~ 4-15	5-00 ~ 5-15	6-00 ~ 6-15	7-00 ~ 7-15	8-00 ~ 8-15
DS1 setting								
	(Factory setting)							

NOTE) ■ indicates the position of switches.

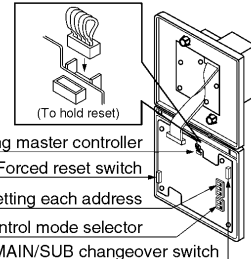

After setting, attach the number seal applicable to respective control range of the attached switch display sticker, as shown in the diagram below.

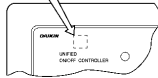

(Example)  
In the case of 1-00 to 1-15, attach 1.

- MAIN/SUB changeover switch setting  
With two unified ON/OFF controllers, centralized control (indoor units) is possible from different locations. In this kind of set-up, it is necessary to set the MAIN/SUB changeover switch.  
One of the two unified ON/OFF controllers (1)-(2) is set to "MAIN" while the other is set to "SUB".

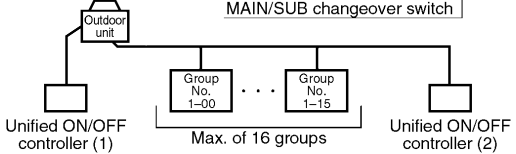

- Setting of the sequential operation function  
The unified ON/OFF controller is equipped with a sequential operation function that sequentially turns indoor units on in 2-second intervals during unified operation. (Sequential operation is factory set to "ON.")  
To switch sequential operation ON or OFF, set as follows.

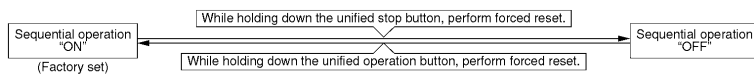

NOTE: The sequential operation function is designed to reduce the load on the power supply equipment, but does not guarantee that compressors will not be started simultaneously. You cannot therefore count on a capacity reduction effect by power supply equipment breaker selection.

- Control mode selector (DS2)  
The following four patterns of control mode can be set.

Control mode	Individual	Centralized	Timer operation possible by remote controller	ON/OFF control impossible by remote controller
Content	Operation/stop is controlled by both unified ON/OFF controller and remote controller.	After operated by unified ON/OFF controller, operation/stop is freely controlled by remote controller until stopped by unified ON/OFF controller.	When used in conjunction with schedule timer, operation/stop is controlled freely by remote controller during the set time but operation is not available when schedule timer is ON.	Operation/stop is controlled by unified ON/OFF controller only. (This unit can not be operated/stopped by remote controller.)
DS2 setting	(Factory set)			

- NOTES)
- indicates the position of switches.
  - Set control mode before turning power supply ON.
  - When used in conjunction with central remote controller, the control modes of the central remote controller has the priority.

- Forced reset switch (SS1)  
When changing the setting of the connector for setting master controller, etc., you can reset simply by setting it to the reset side once and returning to the normal side, without turning the power OFF.  
(For normal operation, set the switch to the normal side.)

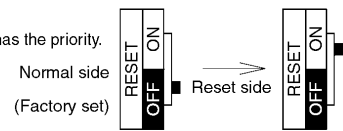

# 5 ELECTRIC WIRING

## GENERAL INSTRUCTIONS

- All wiring, components and materials to be procured on the site must comply with the applicable local and national codes.
- Use copper conductors only.
- All field wiring and components must be provided by licensed electrician.
- Unit shall be grounded in compliance with the applicable local and national codes.
- Fit the power supply wiring with a fuse and a switch.
- After wiring work, check power to the equipment shuts OFF when switch is shut OFF.

## WIRING OUTLINE

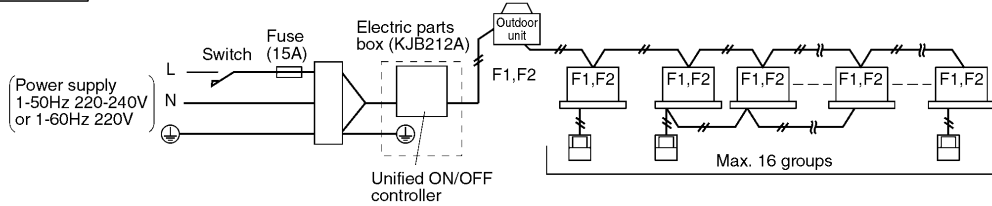

### Wiring specification

	Type	Size
Power supply wiring	H05VV-U3G	(NOTE 1)
Transmission wiring	Sheathed wire (2 wire) (NOTE 2)	0.75 - 1.25mm <sup>2</sup>

- NOTES) 1. The size of power supply wiring must comply with the applicable national and local codes.  
 2. Allowable length of transmission wiring is as follows.  
 Max. 1000m (Total wiring length: 2000m)

Connect the wiring between indoor and outdoor units, indoor/outdoor units and power supply, and indoor units and remote controllers. For details, refer to the installation manuals of indoor and outdoor units.

## WIRING TO THE INDOOR UNIT AND OUTDOOR UNIT

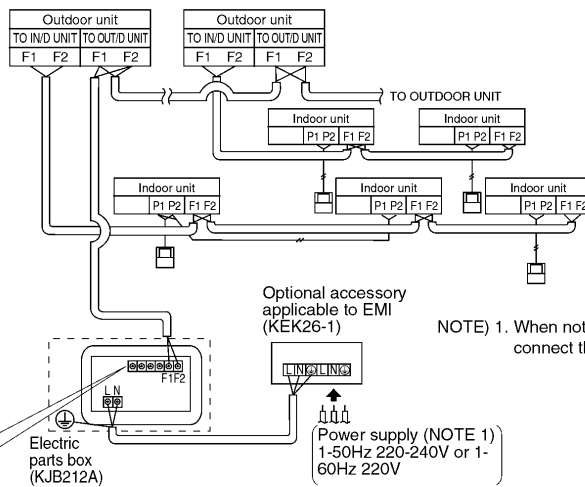

NOTE) 1. When not using the optional accessory applicable to EMI (KEK26-1), connect the power supply wiring directly to the unified ON/OFF controller.

### CONTROL TERMINAL STRIP

- \*1 For connecting indoor unit (F1, F2)
- \*2 Forced OFF input (T1, T2)

While the forced OFF input (no voltage contactor, for micro current) is ON (energized), all the connected indoor units are stopped and can not be operated. Use only contactors which guarantee the minimum applicable load ≧ 16V, 10mA.

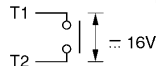

NOTE) Use instantaneous contactor of over 200msec. energizing time, when necessary.

- \*3 For schedule timer (D1, D2)

Power can be supplied to the schedule timer (DST301B51\*61 optional accessory). For details, refer to the installation manual of the schedule timer. Wire \*2 and \*3 only when necessary.

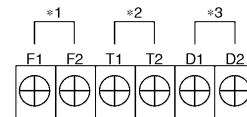







### (NOTE)

Do not connect the power supply wiring (220 to 240V) to the control terminal strip. If connected by mistake, it may damage or burn electrical parts of optional controllers for centralized control and indoor unit. It may result in serious danger. Be sure to check wirings before turning the power ON.



## 6 SETTING GROUP NO. FOR CENTRALIZED CONTROL

Set the group number of each group of the indoor unit from the remote controller. (In case of no remote controller, also connect the remote controller and set the group No. Then, remove the remote controller.)

- 1 Turn ON the power of the indoor unit and unified ON/OFF controller. (Unless the power is ON, no setting can be made.)  
Check that the installation and electrical wiring are correct before turning the power supply ON.  
When the power supply is turned ON, all LCD appear once and the unit may not accept the operation for about one minute with the display of "  " flashing (an interval of ON, ON, and OFF).
- 2 While in the normal mode, hold down the "  " button for a minimum of 4 seconds.  
The remote controller will enter the FIELD SET MODE.
- 3 Select the MODE No. "  " with the "  " button.
- 4 Use the "  " button to select the group No. for each group.  
(Group numbers increase in the order of 1-00, 1-01, ... 1-15, 2-00, ... 8-15.)
- 5 Press "  " to set the selected group No.
- 6 Press "  " to return to the NORMAL MODE.

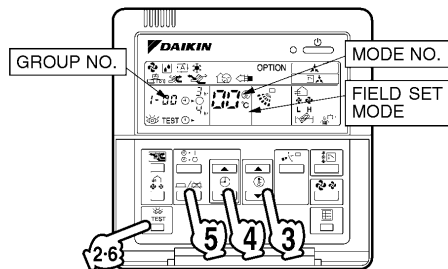

- NOTES)
- For simplified remote controller, see the installation table.
  - For setting group No. of HRV and wiring adaptor for other air conditioners, etc., refer to the instruction manual attached.

**NOTICE** Enter the group No. and installation place of the indoor unit into the attached installation table.  
Be sure to keep the installation table with the operation manual for maintenance.

## 7 CONFIRMING OPERATION

Before starting test operation, supply power to the indoor units, outdoor units, and unified ON/OFF controller and press the ON/OFF BUTTON.

If the operation lamp flashes, it indicates a malfunction in the indoor unit of the applicable group.



If the display of "  " flashes, it indicates a malfunction in the optional controllers for centralized control. Check for such malfunctions.

- NOTES**
- For test operation of indoor and outdoor units, refer to the installation manual attached with the outdoor unit.
  - After turning the power supply ON, if the unit does not accept operation for two minutes or more with the display of "  " flashing, check the following points.
    - Check that setting of the connector for setting master controller is correct.
    - Check that the group No. for centralized control has been set.

## 14.12 <DCS301C71> Unified ON/OFF Controller Operation Manual

Please read these "SAFETY CONSIDERATIONS" carefully before installing air conditioning equipment and be sure to install it correctly. After completing the installation, make sure that the unit operates properly during the start-up operation.  
 Please instruct the customer on how to operate the unit and keep it maintained.  
 Also, inform customers that they should store this installation manual along with the operation manual for future reference.  
 This air conditioner comes under the term "appliances not accessible to the general public"

Meaning of warning, caution and note symbols.

-  **WARNING** ..... Indication a potentially hazardous situation which, if not avoided, could result in death or serious injury.
-  **CAUTION** ..... Indication a potentially hazardous situation which, if not avoided, may result in minor or moderate injury. It may also be used to alert against unsafe practices.
-  **NOTE** ..... Indication situation that may result in equipment or property-damage-only accidents.

**Keep these warning sheets handy so that you can refer to them if needed.**  
 Also, if this equipment is transferred to a new user, make sure to hand over this operation manual to the new user.

### **WARNING**

**In order to avoid electric shock, fire or injury, or if you detect any abnormality such as smell of fire, turn off power and call your dealer for instructions.**

**Ask your dealer for installation of the air conditioner.**

Incomplete installation performed by yourself may result in a water leakage, electric shock, and fire.

**Ask your dealer for improvement, repair, and maintenance.**

Incomplete improvement, repair, and maintenance may result in a water leakage, electric shock, and fire.

**Improper installation or attachment of equipment or accessories could result in electric shock, short-circuit, leaks, fire or other damage to the equipment. Be sure only to use accessories made by Daikin which are specifically designed for use with the equipment and have them installed by a professional.**

**Ask your dealer to move and reinstall the air conditioner or the remote controller.**

Incomplete installation may result in a water leakage, electric shock, and fire.

**Never let the indoor unit or the remote controller get wet.**

It may cause an electric shock or a fire.

**Never use flammable spray such as hair spray, lacquer or paint near the unit.**

It may cause a fire.

**Never replace a fuse with that of wrong ampere ratings or other wires when a fuse blows out.**

Use of wire or copper wire may cause the unit to break down or cause a fire.

**Never inspect or service the unit by yourself.**

Ask a qualified service person to perform this work.

**Cut off all electric waves before maintenance.**

**Do not wash the air conditioner or the remote controller with excessive water.**

Electric shock or fire may result.

**Do not install the air conditioner or the remote controller at any place where flammable gas may leak out.**

If the gas leaks out and stays around the air conditioner, a fire may break out.

**Do not touch the switch with wet fingers.**

Touching a switch with wet fingers can cause electric shock.

### **CAUTION**

**After a long use, check the unit stand and fitting for damage.**

If they are left in a damaged condition, the unit may fall and result in injury.

**Do not allow a child to mount on the unit or avoid placing any object on it.**

Falling or tumbling may result in injury.

**Do not let children play on and around the unit.**

If they touch the unit carelessly, it may result in injury.

**Do not place a flower vase and anything containing water.**

Water may enter the unit, causing an electric shock or fire.

**Never touch the internal parts of the controller.**

Do not remove the front panel. Some parts inside are dangerous to touch, and a machine trouble may happen.

For checking and adjusting the internal parts, contact your dealer.

**Avoid placing the controller in a spot splashed with water.**

Water coming inside the machine may cause an electric leak or may damage the internal electronic parts.

**Do not operate the air conditioner when using a room fumigation - type insecticide.**

Failure to observe could cause the chemicals to become deposited in the unit, which could endanger the health of those who are hypersensitive to chemicals.

**Safely dispose of the packing materials.**

Packing materials, such as nails and other metal or wooden parts, may cause stabs or other injuries.

Tear apart and throw away plastic packaging bags so that children will not play with them. If children play with a plastic bag which was not torn apart, they face the risk of suffocation.

**Do not turn off the power immediately after stopping operation.**

Always wait at least five minutes before turning off the power. Otherwise, water leakage and trouble may occur.

**The appliance is not intended for use by young children or infirm persons without supervision.**

**The remote controller should be installed in such away that children cannot play with it.**

### **NOTE**

**Never press the button of the remote controller with a hard, pointed object.**

The remote controller may be damaged.

**Never pull or twist the electric wire of the remote controller.**

It may cause the unit to malfunction.

**Do not place the controller exposed to direct sunlight.**

The LCD display may get discolored, failing to display the data.

**Do not wipe the controller operation panel with benzine, thinner, chemical dustcloth, etc.**

The panel may get discolored or the coating peeled off. If it is heavily dirty, soak a cloth in water-diluted neutral detergent, squeeze it well and wipe the panel clean. And wipe it with another dry cloth.

**Dismantling of the unit, treatment of the refrigerant, oil and eventual other parts, should be done in accordance with the relevant local and national regulations.**

# 1 NAMES AND FUNCTIONS

**“UNDER HOST COMPUTER INTEGRATED CONTROL” LAMP**  
When this lamp turns on, no other operations are possible.

**GROUP NO.**

**ROOM NAME INDICATION PLATE**  
Refer to the “2. PUTTING ROOM NAME INDICATION STICKER”

**UNIFIED OPERATION/STOP BUTTON**  
Starts/stops all indoor units.

**OPERATION LAMP**  
Turns on during operation of each group and flashes during malfunction stop.

**INDIVIDUAL OPERATION/STOP BUTTON**  
Starts/stops each indoor unit group individually.

**«(NOTE)»**

- When using unified ON/OFF controller with other optional controllers for centralized control, “OPERATION LAMP” of the equipment which is not operated may turn on or off after several minutes. This state occurs due to signal communications and is not a failure.
- Do not open the upper part of remote controller except when rewriting the indication sticker or selecting control modes.

# 2 PUTTING ROOM NAME INDICATION STICKER

- Open the upper part of remote controller. Insert a (-) screwdriver into the recess between the upper and lower part of remote controller (at 2 locations) and twist the screwdriver lightly.
 

PC board is attached both the upper and lower part of remote controller. Do not damage the board with the screwdriver.
- Pull out the room name indication plate. Insert the point of a mechanical pencil etc. into the hole of the indication sticker to pull it out.
- Put the attached indication sticker on the room name indication plate.
 

In case of serial type indication sticker: Put the sticker aligning the lines of the sticker with those of the plate.

In case of individual type indication sticker: Put the sticker on the center of the frame. Write the room name in the frame of the sticker with a ball point pen or a felt-tip pen (oil-base).
- Reinstall the plate as it were, with checking the correct direction.
- Close the upper part of remote controller.

# 3 SELECTING CONTROL MODES

The following four patterns of control mode can be set.

Control mode	Individual	Centralized	Timer operation possible by remote controller	ON/OFF control impossible by remote controller
Content	Operation/stop is controlled by both unified ON/OFF controller and remote controller.	After operated by unified ON/OFF controller, operation/stop is freely controlled by remote controller until stopped by unified ON/OFF controller.	When used in conjunction with schedule timer, operation/stop is controlled freely by remote controller during the set time but operation is not available when schedule timer is ON.	Operation/stop is controlled by unified ON/OFF controller only. Indoor units can not be operated/stopped by remote controller.
DS2 setting				

**NOTE:**

- indicates the position of switches.
- Set control modes before turning power supply on.
- When used in conjunction with central remote controller, the control modes of the central remote controller has the priority.

# 4 DISPLAY OF MALFUNCTION

Flashing of lamps indicates malfunctions. Contact your Daikin dealer. When turning power supply on, all lamps may light and UNDER HOST COMPUTER INTEGRATED CONTROL lamp may flash and not accept the operation for about on minute. These conditions are not malfunctions.

States of lamps	Contents of malfunctions
Flashing of operation lamp	Indicates malfunctions in the indoor unit in the group where the operation lamp is flashing.
Flashing of UNDER HOST COMPUTER INTEGRATED CONTROL lamp	Indicates malfunctions in optional controllers for centralized control.

### 14.13 <DST301BA61> Schedule Timer Controller

Enables you to connect and control weekly schedule for up to 128 indoor units all together.



- Simultaneous control of up to 128 indoor units is managed by a week schedule.
- The start and stop time for twice a day can be set for the week in increments of 1 minute.
- By combining with a central remote controller and schedule timer, you can construct a system that matches the size and use of the building.
- If used together with a central remote controller, you can set up to 8 schedule patterns which can be distributed among zones as desired using the central remote controller.
- Is equipped with a compensation function for power failure up to 48 hours.
- Features thin design of a mere 16 mm in thickness. (Uses JIS recessed box for 2.)
- Wiring can be up to 1 km in length. Applicable wiring methods include bus and star in addition to crossover type.
- Can be used in combination with other D-BACS equipment.

#### Specifications / Dimensions

#### SPECIFICATIONS

##### ■ Specifications

Display of time	12-hour digital display
Clock cycle type	Quartz clock type
Clock accuracy	Within ±30 sec./month (environmental temperature from 15°C to 35°C)
Timer programming	Two pairs of programmed time for both system start and system off can be set in units of minute for each day of the week
Power failure compensation time	Approximately 48 hours for a single occurrence of power failure (clock with No. of programmed time)
Size	120 (W) × 120 (H) × 53 (D) mm (Width/Height/Depth)
Weight	Approximately 210g

##### ■ Outline drawings

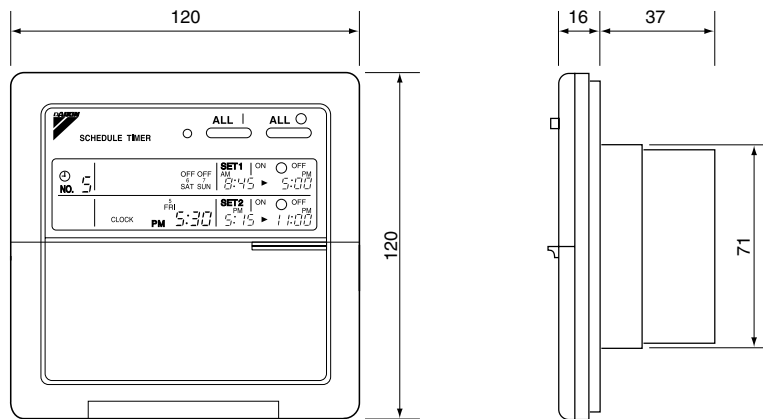

Specifications and appearance subject to change without notice.

## 14.14 <DST301BA61> Schedule Timer Controller Installation Manual

Please read these "SAFETY CONSIDERATIONS" carefully before installing air conditioning equipment and be sure to install it correctly. After completing the installation, make sure that the unit operates properly during the start-up operation. Please instruct the customer on how to operate the unit and keep it maintained. Also, inform customers that they should store this installation manual along with the operation manual for future reference. This air conditioner comes under the term "appliances not accessible to the general public".

Meaning of warning, caution and note symbols.

- ⚠ WARNING** .....Indication a potentially hazardous situation which, if not avoided, could result in death or serious injury.
- ⚠ CAUTION** .....Indication a potentially hazardous situation which, if not avoided, may result in minor or moderate injury. It may also be used to alert against unsafe practices.
- ⚠ NOTE** .....Indication situation that may result in equipment or property-damage-only accidents.

### **⚠ WARNING**

**Ask your dealer or qualified personnel to carry out installation work. Do not try to install the machine by yourself.**  
Improper installation may result in water leakage, electric shocks or fire.

**Perform installation work in accordance with this installation manual.**  
Improper installation may result in water leakage, electric shocks or fire.

**Be sure to use only the specified accessories and parts for installation work.**  
Failure to use the specified parts may result in water leakage, electric shocks, fire or the unit falling.

**Carry out the specified installation work after taking into account strong winds, typhoons or earthquakes.**  
Improper installation work may result in the equipment falling and causing accidents.

**Make sure that a separate power supply circuit is provided for this unit and that all electrical work is carried out by qualified personnel according to local laws and regulations and this installation manual.**  
An insufficient power supply capacity or improper electrical construction may lead to electric shocks or fire.

**Make sure that all wiring is secured, the specified wires and used, and no external forces act on the terminal connections or wires.**  
Improper connections or installation may result in fire.

**When wiring the power supply and connecting the remote controller wiring and transmission wiring, position the wires so that the electric parts box lid can be securely fastened.**  
Improper positioning of the electric parts box lid may result in electric shocks, fire or the terminals overheating.

**Before touching electrical parts, turn off the unit.**

**Ground the air conditioner. Do not connect the ground wire to gas or water pipes, lightning rod or a telephone ground wire.**  
Incomplete grounding may result in electric shocks.

**When installing or relocating the system, be sure to keep the refrigerant circuit free from substances other than the specified refrigerant (R410A), such as air.**

**Do not reconstruct or change the settings of the protection devices.**  
If the pressure switch, thermal switch, or other protection device is shorted and operated forcibly, or parts other than those specified by Daikin are used, fire or explosion may result.

**Do not touch the switch with wet fingers.**  
Touching a switch with wet fingers can cause electric shock.

**Install an earth leak circuit breaker, as required.**  
If an earth leak circuit breaker is not installed, electric shock may result.

**Do not install the air conditioner or the remote controller in the following locations:**

- (a) where a mineral oil mist or an oil spray or vapor is produced, for example in a kitchen  
Plastic parts may deteriorate and fall off or result in water leakage.
- (b) where corrosive gas, such as sulfurous acid gas, is produced  
Corroding copper pipes or soldered parts may result in refrigerant leakage.
- (c) near machinery emitting electromagnetic waves  
Electromagnetic waves may disturb the operation of the control system and result in a malfunction of the equipment.
- (d) where flammable gases may leak, where there are carbon fiber or ignitable dust suspensions in the air, or where volatile flammables such as thinner or gasoline are handled.  
Operating the unit in such conditions may result in fire.

**CISPR 22 Class A Warning.**

This is a class A product. In a domestic environment this product may cause radio interference in which case the user may be required to take adequate measures.

**⚠ CAUTION**

**Be very careful about product transportation.**

**Safely dispose of the packing materials.**

Packing materials, such as nails and other metal or wooden parts, may cause stabs or other injuries. Tear apart and throw away plastic packaging bags so that children will not play with them. If children play with a plastic bag which was not torn apart, they face the risk of suffocation.

**Do not turn off the power immediately after stopping operation.**

Always wait at least five minutes before turning off the power. Otherwise, water leakage and trouble may occur.

**⚠ NOTE**

**Install the indoor and outdoor units, power supply wiring and connecting wires at least 3.5ft. away from televisions or radios in order to prevent image interference or noise.**

(Depending on the radio waves, a distance of 3.5ft. may not be sufficient enough to eliminate the noise.)

**Remote controller (wireless kit) transmitting distance can result shorter than expected in rooms with electronic fluorescent lamps. (inverter or rapid start types)**

Install the indoor unit as far away from fluorescent lamps as possible.

**This unit is a class A product.**

In a domestic environment this product may cause radio interference in which case the user may be required to take adequate measures.

**Dismantling of the unit, treatment of the refrigerant, oil and eventual other parts, should be done in accordance with the relevant local and national regulations.**



# 1 ACCESSORIES

Check the following accessories are included in the kit before installation.

Body	1	Installation screws (M4 × 16)	2
Operation manual	1	Attached electric wire (for individual use)	1
Installation manual*	4	Crimp style terminal (for individual use)	2

For Installation, a electrical box to be embedded is necessary (part to be procured in the field/with covers).

\* DST301BA61 includes only one installation manual.

# 2 INSTALLATION AND INITIAL SETTING

## 1. Remove the upper part of the remote controller.

- Insert a (-) screwdriver (2 locations) into the recess between the upper part and the lower part of the remote controller and twist the screwdriver lightly.

(The PC board is attached with the upper part of the remote controller. Do not damage electric parts with a screwdriver, etc.)

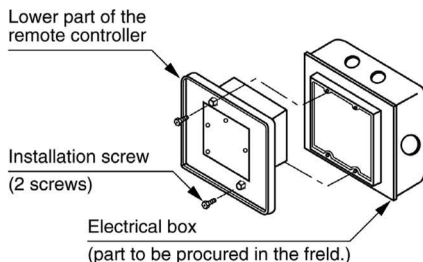
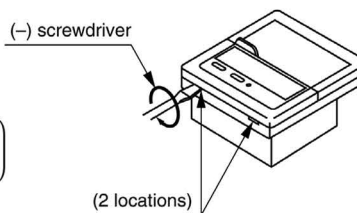

- Attach the lower part to the electrical box (part to be procured in the field) with the provided installation screws.

(Select a flat face as a installation place. Do not tighten the installation screws excessively not to damage the lower part of the remote controller.)

For part to be procured in the field electrical box, use KJB212AA (optional accessory).

## 2. Initial setting

### ① Setting connector for individual use (X1A) (Factory set : OFF) (Set for individual use only)

- For individual use of schedule timer  
Insert the connector attached with the body case on the PC board.
- For combined use with other optional controllers for centralized control  
Do not change the factory setting.

### ② Control mode selector (SS2) (Set for individual use only)

By changing the switch, setting mode of individual and centralized operation is available.

Note) When used with other optional controllers, control mode of central remote controller and unified ON/OFF controller have the priority.



### ③ Setting of the sequential operation function

The schedule timer is equipped with a sequential operation function that sequentially turns indoor units on in 2-second intervals during unified operation. (Sequential operation is factory set to "ON.")

To switch sequential operation ON or OFF, set as follows.

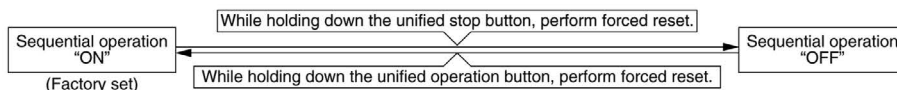

Note) The sequential operation function is designed to reduce the load on the power supply equipment, but does not guarantee that compressors will not be started simultaneously. You cannot therefore count on a capacity reduction effect by power supply equipment breaker selection.

④ Forced reset switch (SS1)

When changing the setting of the connector for individual use, etc., the switch can be reset simply by setting it to the reset side once and returning to the normal side. This procedure enables to reset without turning off the power. (Set the normal side at normal operation.)

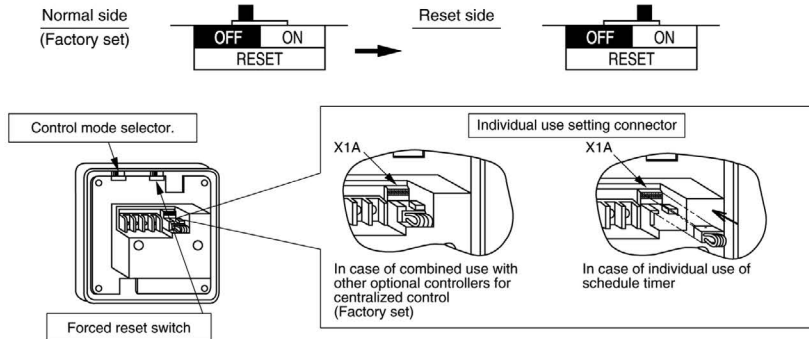

⑤ Setting for special function

When you want to have a programmed operation of a part of indoor units by using only schedule timer, cut off JP1 and supply the power again. You can have a programmed operation of the indoor units set the address for central control by local remote controller.

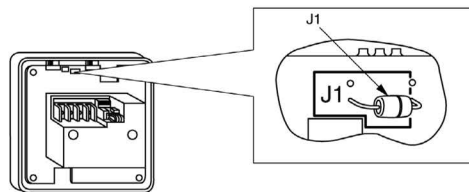

3. Transmission wiring

- In case of individual use of schedule timer  
Connect terminals of the schedule timer (F1, F2) with terminals of the indoor unit (F1, F2). Connect terminals of the schedule timer (D1, D2) and the connector on the indoor unit PC board, using the attached electric wire and crimp style terminals. Prevent the connection part of crimp style terminal from getting out of the electric parts box of indoor unit.
- In case of combined use with other optional controllers for centralized control  
Connect terminals of the schedule timer (F1, F2, D1, D2) and the terminals of the central remote controller (or unified ON/OFF controller).

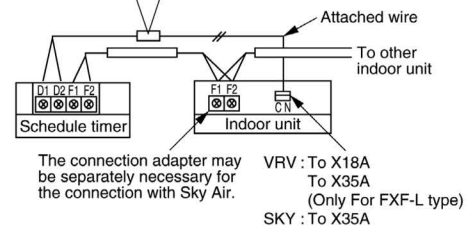
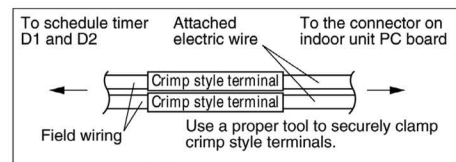

Wiring specifications

	F1, F2	D1, D2
Wiring	Sheathed wire (2-wire)	Sheathed wire (2-wire)
Gauge	0.75 ~ 1.25mm <sup>2</sup>	0.75 ~ 1.25mm <sup>2</sup>
Length	Max. 1000m	Max. 150m

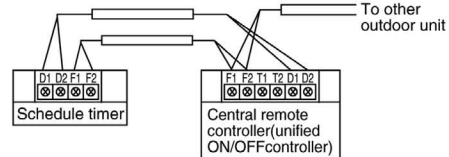

NOTES:

- Electrical box and transmission wiring are not attached.
- Do not touch the PC board with your hand.
- Keep transmission wiring at least 50 mm away from power supply wiring to avoid malfunctions.

4. Install the upper part of the remote controller as before.

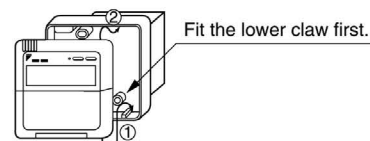



### 3 SETTING GROUP NO. FOR CENTRALIZED CONTROL

Set the group number of each group of the indoor unit from the remote controller. (In case of no remote controller, also connect the remote controller and set the group No. Then, remove the remote controller.)

(1) Turn ON the power of the indoor unit and SCHEDULE TIMER.  
 (Unless the power is ON, no setting can be made.)  
 Check that the installation and electrical wiring are correct before turning the power supply ON.  
 (When the power supply is turned ON, all LCD appear once and the unit may not accept the operation for about one minute with the display of "88".)

(2) While in the normal mode, hold down the "TEST" button for a minimum of 4 seconds.  
 The remote controller will enter the FIELD SET MODE.

(3) Select the MODE No. "00" with the "MODE" button.

(4) Use the "GROUP" button to select the group No. for each group.

(Group numbers increase in the order of 1-00,1-01,...1-15, 2-00,...8-15.)

(5) Press "OK" to set the selected group No.

(6) Press "EXIT" to return to the NORMAL MODE.

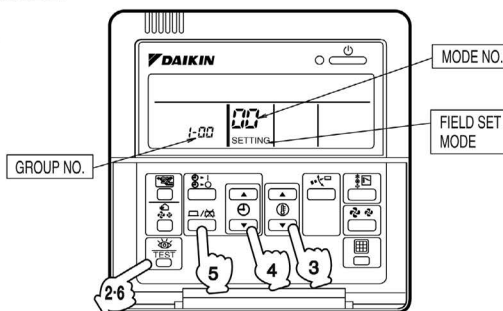

- NOTES)
- In case of individual use of schedule timer Group number setting is not necessary. It is automatically set when turning power supply ON.
  - See the instruction manuals which came with the VentiAir and adapters (i.e., multi-purpose adapters) for details on their Group No. settings.

NOTICE Be sure to keep the operation manual for maintenance.

### 4 TEST OPERATION

Refer to the installation manual attached to the outdoor unit.

In case the schedule timer is used individually and the wiring is changed after the system has been operated, reset the power after energizing for more than five minutes. It may not be possible to control the unit from the schedule timer.

### 14.15 <DST301BA61> Schedule Timer Controller Operation Manual

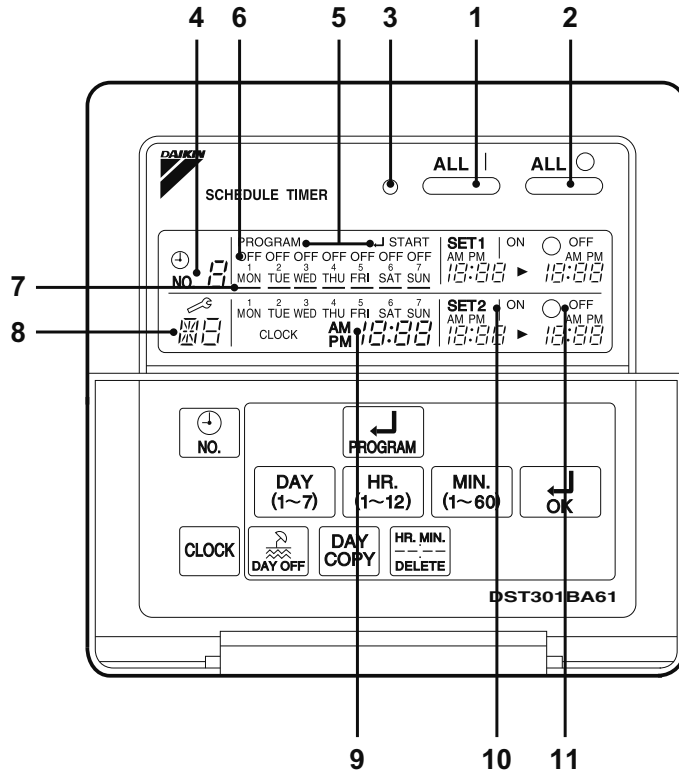

1

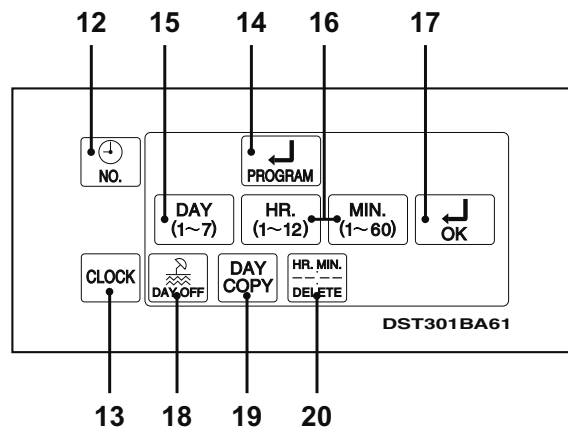

2

[1]

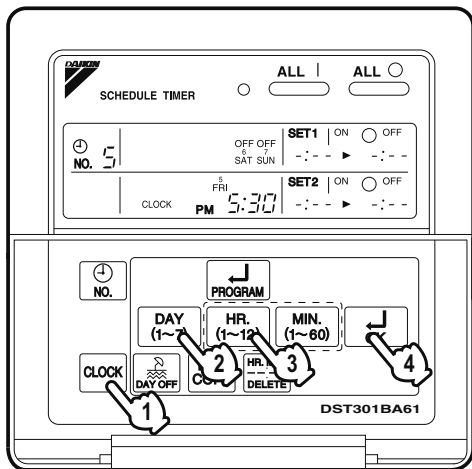

3

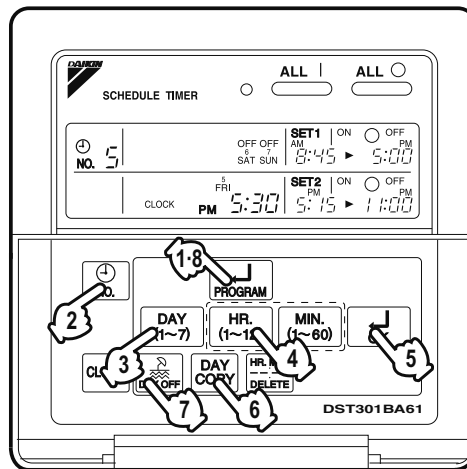

4

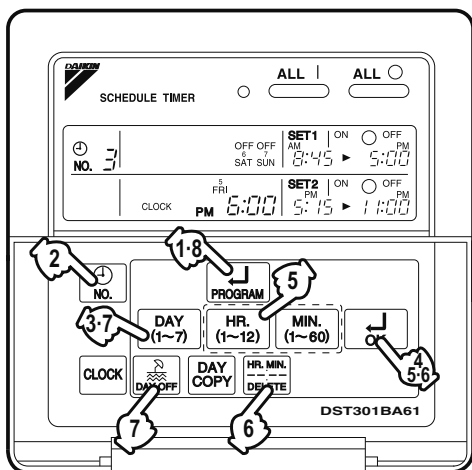

5

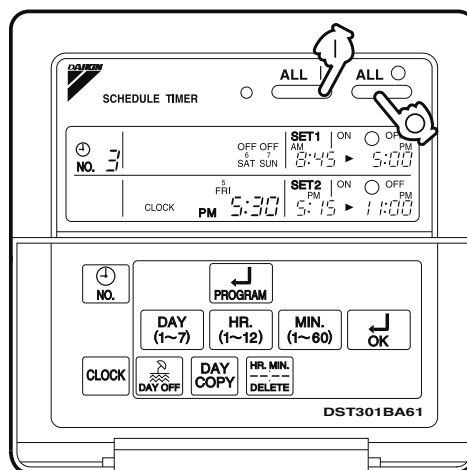

6

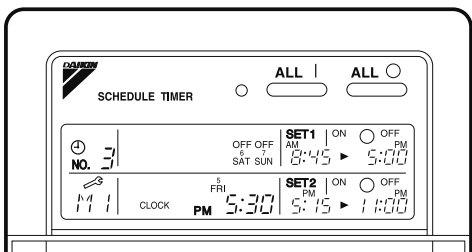

7

[2]

## SAFETY CONSIDERATIONS

Please read these " SAFETY CONSIDERATIONS " carefully before installing air conditioning equipment and be sure to install it correctly. After completing the installation, make sure that the unit operates properly during the start-up operation.

Please instruct the customer on how to operate the unit and keep it maintained.

Also, inform customers that they should store this installation manual along with the operation manual for future reference.

This air conditioner comes under the term " appliances not accessible to the general public ".

Meaning of warning, caution and note symbols.

 **WARNING** ..... Indicates a potentially hazardous situation which, if not avoided, could result in death or serious injury.

 **CAUTION** ..... Indicates a potentially hazardous situation which, if not avoided, may result in minor or moderate injury. It may also be used to alert against unsafe practices.

 **NOTE** ..... Indicates situation that may result in equipment or property-damage-only accidents.

**Keep these warning sheets handy so that you can refer to them if needed.**

Also, if this equipment is transferred to a new user, make sure to hand over this operation manual to the new user.

### **WARNING**

**In order to avoid electric shock, fire or injury, or if you detect any abnormality such as smell of fire, turn off power and call your dealer for instructions.**

**Ask your dealer for installation of the air conditioner.**

Incomplete installation performed by yourself may result in a water leakage, electric shock, and fire.

**Ask your dealer for improvement, repair, and maintenance.**

Incomplete improvement, repair, and maintenance may result in a water leakage, electric shock, and fire.

**Improper installation or attachment of equipment or accessories could result in electric shock, short-circuit, leaks, fire or other damage to the equipment. Be sure only to use accessories made by Daikin which are specifically designed for use with the equipment and have them installed by a professional.**

**Ask your dealer to move and reinstall the air conditioner or the remote controller.**

Incomplete installation may result in a water leakage, electric shock, and fire.

**Never let the indoor unit or the remote controller get wet.**

It may cause an electric shock or a fire.

**Never use flammable spray such as hair spray, lacquer or paint near the unit.**

It may cause a fire.

**Never replace a fuse with that of wrong ampere ratings or other wires when a fuse blows out.**

Use of wire or copper wire may cause the unit to break down or cause a fire.

**Never inspect or service the unit by yourself.**

Ask a qualified service person to perform this work.

**Cut off all electric waves before maintenance.**

**Do not wash the air conditioner or the remote controller with excessive water.**

Electric shock or fire may result.

**Do not install the air conditioner or the remote controller at any place where flammable gas may leak out.**

If the gas leaks out and stays around the air conditioner, a fire may break out.

**Do not touch the switch with wet fingers.**

Touching a switch with wet fingers can cause electric shock.

**CISPR 22 Class A Warning:**

This is a class A product. In a domestic environment this product may cause radio interference in which case the user may be required to take adequate measures.

### — CAUTION —

**After a long use, check the unit stand and fitting for damage.**

If they are left in a damaged condition, the unit may fall and result in injury.

**Do not allow a child to mount on the unit or avoid placing any object on it.**

Falling or tumbling may result in injury.

**Do not let children play on and around the unit.**

If they touch the unit carelessly, it may result in injury.

**Do not place a flower vase and anything containing water.**

Water may enter the unit, causing an electric shock or fire.

**Never touch the internal parts of the controller.**

Do not remove the front panel. Some parts inside are dangerous to touch, and a machine trouble may happen.

For checking and adjusting the internal parts, contact your dealer.

**Avoid placing the controller in a spot splashed with water.**

Water coming inside the machine may cause an electric leak or may damage the internal electronic parts.

**Do not operate the air conditioner when using a room fumigation - type insecticide.**

Failure to observe could cause the chemicals to become deposited in the unit, which could endanger the health of those who are hypersensitive to chemicals.

**Safely dispose of the packing materials.**

Packing materials, such as nails and other metal or wooden parts, may cause stabs or other injuries.

Tear apart and throw away plastic packaging bags so that children will not play with them. If children play with a plastic bag which was not torn apart, they face the risk of suffocation.

**Do not turn off the power immediately after stopping operation.**

Always wait at least five minutes before turning off the power. Otherwise, water leakage and trouble may occur.

**The appliance is not intended for use by young children or infirm persons without supervision.**

**The remote controller should be installed in such way that children cannot play with it.**

### — NOTE —

**Never press the button of the remote controller with a hard, pointed object.**

The remote controller may be damaged.

**Never pull or twist the electric wire of the remote controller.**

It may cause the unit to malfunction.

**Do not place the controller exposed to direct sunlight.**

The LCD display may get discolored, failing to display the data.

**Do not wipe the controller operation panel with benzine, thinner, chemical dustcloth, etc.**

The panel may get discolored or the coating peeled off. If it is heavily dirty, soak a cloth in water-diluted neutral detergent, squeeze it well and wipe the panel clean. And wipe it with another dry cloth.

**Dismantling of the unit, treatment of the refrigerant, oil and eventual other parts, should be done in accordance with the relevant local and national regulations.**

## CONTENTS

<p>SAFETY CONSIDERATIONS .....1</p> <p>FEATURES AND FUNCTIONS .....3</p> <p>NAMES AND FUNCTIONS OF OPERATING SECTION .....4</p> <p>OPERATION .....5</p> <p>Setting present time .....5</p> <p>Setting no. of programmed time .....6</p>	<p>Change and cancellation of no. of programmed time .....7</p> <p>Manual operation .....9</p> <p>Operation control code .....9</p> <p>Error diagnosing function .....9</p> <p>QUESTION AND ANSWER .....10</p> <p>SPECIFICATIONS .....12</p> <p>Specifications .....12</p> <p>Outline drawings .....12</p>
---	--

## FEATURES AND FUNCTIONS

**■ Operation controlled by programmed time**  
 Operating time and stopping time can be set to the minute by each day of the week. The operating and stopping patterns can also be set in schedule according to the time slot given twice a day in tune with the uses.

➔

See page  
5—9.



**■ Unified Operation/Stop**  
 By using this schedule timer, the unified operation/stop of the indoor unit can be executed manually regardless of the No. of programmed time in operation.





➔

See page  
9.

- **When used in conjunction with central remote controller (Optional Accessory)**  
 The operation controlled by programmed time can be set for up to eight different patterns (timer No. 1 – 8). Each schedule pattern can be also selected.

## NAMES AND FUNCTIONS OF OPERATING SECTION (Fig. 1, 2)

1	<b>UNIFIED OPERATION BUTTON</b> “ ALL   ” 	Press this button to perform the unified operation regardless of the No. of programmed time.	9	<b>DISPLAY</b> “ <small>MÓN TUE WED THU FRI SAT SUN</small> CLOCK <small>AM PM</small> 12:00 ” <b>(PRESENT TIME)</b>	Displays the present day of the week and time.
	2			<b>UNIFIED STOP BUTTON</b> “ ALL ○ ” 	
3		<b>OPERATION LAMP (RED)</b>	The light turns on during the operation of the indoor unit.	11	<b>DISPLAY</b> “ <small>OFF</small> <small>AM PM</small> 12:00 ” <b>(PROGRAMMED TIME OF SYSTEM OFF)</b>
	4	<b>DISPLAY</b> “ <small>NO.</small> 8 ” <b>(TIME NO.)</b>			Displays the time No. only when used in conjunction with the central remote controller.
5		<b>DISPLAY</b> “PROGRAM ↵ START.” <b>(PROGRAMMING START)</b>	The light turns on when the timer is programmed.	13	
	6	<b>DISPLAY</b> “ OFF ” <b>(HOLIDAY SETTING)</b>			Lights above the day of the week set as holiday. The operation controlled by timer is not available on that day.
7		<b>DISPLAY</b> “ — ” <b>(SETTING OF DAYS OF A WEEK)</b>	Flashes below the day of the week programmed.	15	
	8	<b>DISPLAY</b> “  ” <b>(MALFUNCTION CODE)</b>			Displays the contents of malfunction during the stop due to malfunction.

<b>17</b>	<p><b>TIMER ON BUTTON</b> “  ”</p> <p>Press this button to set the present time and the programmed time.</p>
<b>18</b>	<p><b>HOLIDAY SETTING</b></p> <p><b>BUTTON</b> “  ”</p> <p>Press this button to set holidays.</p>
<b>19</b>	<p><b>BUTTON FOR COPYING PROGRAM OF PREVIOUS DAY</b> “  ”</p> <p>Use this button to set the No. of programmed time same as that of the previous day.</p>
<b>20</b>	<p><b>PROGRAM CANCELING</b></p> <p><b>BUTTON</b> “  ”</p> <p>Use this button to set the programmed time to cancel. The display shows “-; - -”.</p>
<p>(Note)</p> <p>1. Please note that all the displays in the figure appear for explanation purpose or when the cover is open.</p>	

## OPERATION

### ■ Setting present time (Fig. 3)

(Example) In case of setting Friday, 5:30 p.m.

1.  Press the **CLOCK ADJUSTING BUTTON**. The present time display flashes.

(NOTE)

- The present time needs adjusting in case of turning power supply on for the first time or the occurrence of power failure over the period of 48 hours or more.



2.  Press the **BUTTON FOR SELECTING DAYS OF A WEEK**. Each time the button is pressed, the day display shifts to the right.

(NOTE)

- The display “ MON ” follows the display “ SUN. ”

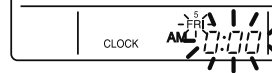

Set the day to Friday.

3.  Set the time with the **HOUR/MINUTE BUTTON**. Each time the HOUR/MINUTE BUTTON is pressed, the display is put forward minute by minute and hour by hour. When the button is kept pressed, the display is put forward continuously.

(NOTES)

- After becoming “ AM 11:00 ”, when the button is pressed, the display becomes “ PM 0:00 ”.
- After becoming “ 59 ” (minute), when the button is pressed, the display becomes “ 00 ” (minute).

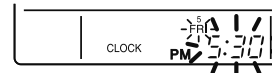

Set the time to 5:30 p.m.

4.  Press the **TIMER ON BUTTON** the moment the time signal of TV, radio, telephone, etc. is heard. The mark “ : ” flashes, and the clock starts.

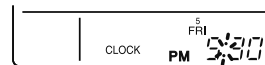

Press the **TIMER ON BUTTON** in tune with the time signal at 5:30 p.m.

(NOTES)

- The clock used is of 12-hour type.
- When you turn power supply on, the system may display “ 88 ” for about one minute and not start to operate after all the liquid crystal displays appear at a time.
- If the **CLOCK ADJUSTING BUTTON** is pressed by mistake, press it again to return to the original state. As the clock does not stop, the time indicated by the clock is kept correct. In case of power failure within 48 hours, the clock keeps operating by utilizing the built-in battery.



## ■ Setting no. of programmed time (Fig. 4)

(Example) Time No. 5 (to be programmed only when used in conjunction with the central remote controller)

### Monday to Friday:

Operating from 8:45 a.m. till 5:00 p.m.

Operating from 5:15 p.m. till 11:00 p.m.

### Saturday and Sunday:

Setting the whole day stop operation (application for holidays) controlled by programmed time.

1. Press the PROGRAMMING START BUTTON. Programming is available. The display "PROGRAM J START" appears, and the display of days of a week flashes.

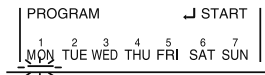

2. Press the TIME No. BUTTON, and select the desired number.

(NOTE)

- Unless used in conjunction with the central remote controller, The TIME No. is not displayed and can not be selected.

Select the TIME No. 5.

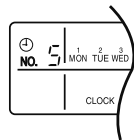

3. Press the BUTTON FOR SELECTING DAYS OF A WEEK, and set the proper day of the week. Each time you press it, the flashing display of days of a week shifts to the right.



Set to Monday.

## (1) Setting programmed time

4. Set the programmed time of system start 1 by using the HOUR/MINUTE BUTTON. Each time the HOUR/MINUTE BUTTON is pressed, the display is put forward minute by minute and hour by hour. When the button is kept pressed, the display is put forward continuously.



Set the "PROGRAMMED TIME OF SYSTEM START 1" at 8:45 a.m.

5. Press the TIMER ON BUTTON, and set the programmed time of system start 1. Each time you press it, the next area to be set flashes.

(NOTE)

- Set the other programmed time in the same procedure.

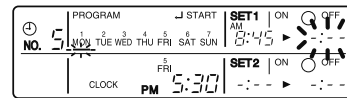

- (2) **Set the next day of the week.**  
 Set the day of the week to Tuesday, and copy the program of the previous day (Monday). In the same procedure, set the day of the week to Wednesday through Friday in sequence.

6.  **Press the BUTTON FOR SELECTING DAYS OF A WEEK and set the following day. Press the BUTTON FOR COPYING PROGRAM OF PREVIOUS DAY. The same program as that of the immediately preceding day of the week is set.**

(NOTE)

- Repeat each procedure 3 – 5 in the above when not copying the contents of the previous day.

- (3) **Holiday setting**

7.  **Press the BUTTON FOR SELECTING DAYS OF A WEEK and set one or more days of the week as holiday. Press the HOLIDAY SETTING BUTTON, and the display “ OFF ” is displayed at the top of the day of the week. If you press it again, the display returns to the original state.**



Set Saturday and Sunday as holidays.

8.  **Press the PROGRAMMING START BUTTON, and finish the program setting.**

(NOTES)

- Unless the button is pressed within 20 minutes, the display will automatically revert back to the original state. In this case, setting contents up to the point where the TIMER ON BUTTON (or HOLIDAY SETTING BUTTON or BUTTON FOR COPYING PROGRAM OF PREVIOUS DAY) is pressed will only take effect.
- The display “ PROGRAM ↵ START ” and the display of days of a week “ — ” disappears.

- The flashing display goes off, and the No. of programmed time of the present day is displayed. Then the operation controlled by timer starts.
- The operation controlled by timer is executed even while the program is being set.





This is the end of the setting example.

### ■ Change and cancellation of no. of programmed time (Fig. 5)

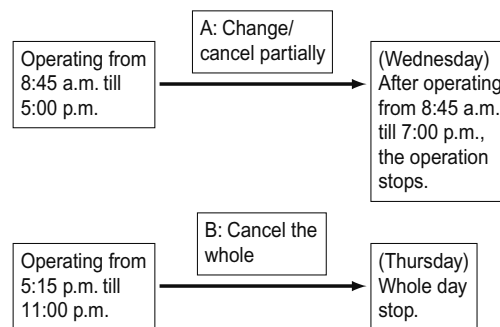
(Example) **Time No. 3 (to be set only when used in conjunction with the central remote controller)**



-  **Press the PROGRAMMING START BUTTON. The program setting is ready. The display “ PROGRAM ↵ START ” appears, and the display of days of a week flashes.**
-  **Press the TIME No. BUTTON, and select the desired No.**



Select the time No. 3.

3.  Press the **BUTTON FOR SELECTING DAYS OF A WEEK**, and set the day of the week to be changed. The set No. of programmed time of the day of the week is displayed.

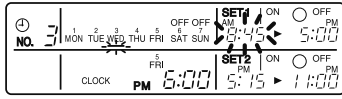

Set the day to Wednesday.

**A. Change/cancel partially**

4.  Press the **TIMER ON BUTTON** and change, and the display of programmed time flashes. Each time you press it, the next area to be set flashes.



Shift to the display "PROGRAMMED TIME OF SYSTEM OFF 1".

5.  Press the **HOUR/MINUTE BUTTON** and change the programmed time. Press the **TIMER ON BUTTON**, and finalize the setting of change.



Change the "PROGRAMMED TIME OF SYSTEM OFF 1" to 7:00 p.m.

6.  Press the **PROGRAM CANCELING BUTTON**, and cancel the programmed time. If you press it again, display returns to the original state. Press the **TIMER ON BUTTON** to finalize the cancellation.



Shift to the "PROGRAMMED TIME OF SYSTEM START 2".

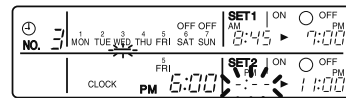

Set the "PROGRAMMED TIME OF SYSTEM START 2" to program cancellation.

In the same procedure, cancel the programmed time of system off 2.

**B. Cancel the whole**

7.  Press the **BUTTON FOR SELECTING DAYS OF A WEEK**, and shift to the day of the week to be canceled. Then, press the **HOLIDAY SETTING BUTTON**, the display "OFF" appears at the top of the particular day of the week. The programmed time is canceled. If you press the button again, the display returns to the original state.

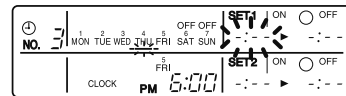

Shift the day of the week to Thursday to set as a holiday.



**8.  Press the PROGRAMMING START BUTTON. The program setting is now finished.**

**(NOTES)**

- Unless the button is pressed within 20 minutes, the display will automatically revert back to the original state. In this case, setting contents to the point where the TIMER ON BUTTON (or HOLIDAY SETTING BUTTON or BUTTON FOR COPYING PROGRAM OF PREVIOUS DAY) is pressed will only take effect.
- To continue the change/cancellation, do not press the PROGRAMMING START BUTTON until all change/cancellation are completed.
- The operation controlled by timer is executed even while the program is being set.

**■ Manual operation (Fig. 6)**

This schedule timer enables the operation/stop by pressing the UNIFIED OPERATION/STOP BUTTON in addition to the operation controlled by timer (operation/stop according to the programmed time) at any time.

- 1.  Press the UNIFIED OPERATION BUTTON, and the OPERATION LAMP turns on.**
- 2.  Press the UNIFIED STOP BUTTON, and the OPERATION LAMP is turned off.**

**(NOTES)**

- The operation automatically stops according to the programmed time of system off even during the manual operation. In the meantime, the operation starts automatically according to the programmed time of system start even during the stop of operation.
- If the unit is used in conjunction with other optional controllers for centralized control, the OPERATION LAMP of the unit that is not under operation control may be turned on or off a few minutes behind schedule. This shows that the signal is being exchanged, and does not indicate any failure.

Operation lamp	
<input type="radio"/>	Turn on: The light turns on when any of the indoor units is in operation whether the operation is controlled by timer or by hand.
<input checked="" type="radio"/>	Turn off: The light turns off when all the indoor units stop.

**■ Operation control code**

Two different types of operation control codes can be selected when this kit is used independently (when not used in conjunction with the central remote controller, unified ON/OFF controller, etc.).

**Individual**

In case where the operation/stop is controlled by both schedule timer and remote controller.

**Centralized**

The operation is controlled by the schedule timer alone, and the operation/stop is controlled freely with the remote controller during the programmed time.

**(NOTES)**

- For current settings, contact your DAIKIN dealer.
- To change settings, contact your DAIKIN dealer.  
Do not change settings yourself.

**■ Error diagnosing function (Fig. 7)**



This schedule timer is provided with the malfunction diagnosing function. The malfunction code flashes if there occurs any malfunction in communication, etc. between and among the optional controllers for centralized control. In addition, the operation lamp also flashes if there occurs any malfunction in communication with the indoor unit. Check the contents of the display and contact your DAIKIN dealer because the signals give you the idea of the trouble area.

Operation lamp	Malfunction code	Contents of malfunction
Turn off	M1	Failure of PC board of schedule timer. <b>Fixes</b> The following causes are possible. Check each one. 1. PC board problems
Turn on or off	M8	Malfunction of transmission between each optional controllers for centralized control. <b>Fixes</b> Check all central devices which are connected (e.g., power supply, transmission wiring, etc.).
Turn on or off	MA	Improper combination of optional controllers for centralized control. <b>Fixes</b> The following causes are possible. Check each one. 1. Are all central devices combined correctly? 2. Is the master central connector attached to two or more central devices? 3. Are there 128 or more indoor units connected?

Turn on or off	MC	Address failure of schedule timer. <b>Fixes</b> The following causes are possible. Check each one. 1. Do the control range addresses in the central remote controller overlap? 2. Do the control range addresses in the on/off controller overlap? 3. Are there 2 or more schedule timers connected?
Flash	UE	Malfunction of transmission between indoor unit and optional controllers for centralized control. <b>Fixes</b> Inspect all indoor units which are displaying an error (e.g., power supply, transmission wiring, etc.).
Flash	—	Malfunction in indoor unit (Refer to the malfunction codes of the indoor remote controller, while also read the "CAUTION FOR SERVICING" attached to the indoor unit.)

## QUESTION AND ANSWER

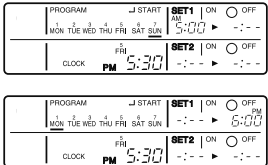
Question	Answer
It is possible to make settings twice a day, but is it possible to make only the "off" setting? (To avoid forgetting to turn the unit off.)	Yes. Press the PROGRAM CANCELING BUTTON in the "AM/PM   ON   12:00" section in order to set it to "OFF".

<p>Is it possible to set times which straddle days?</p>	<p>Yes, it is possible. Example: Start operation at 5:00 a.m. on Sunday Stop operation at 6:00 p.m. on Monday</p> 	<p>The TIME NO. is not displayed.</p>	<p>The following causes are possible. 1. The TIME NO. is not displayed when using the schedule timer alone. (It can be set if using the central remote controller at the same time.)</p>
<p>The unit does not turn on even though the set "on" time has come. (When using the schedule timer alone)</p>	<p>The following causes are possible. 1. Are the "on" time and the "off" time set to the same time?</p>	<p>The display remains</p>  <p>even though I push the HOUR/MINUTE BUTTON in the timer program settings.</p>	<p>The following causes are possible. 1. Is the day set to a holiday?</p>
<p>The unit does not turn on even though the set "on" time has come. (When using the unit with a central remote controller)</p>	<p>The following causes are possible. Check each one. 1. Was the timer number set with the central remote controller? Was an incorrect timer number set? 2. Is another timer no. set with the central remote controller set for "off" at the same time? 3. Is the operation code set to "remote control permission timer" using the central remote controller or the on/off controller?</p>	<p>I cannot set "central management priority" or "after-push priority" with the schedule timer.</p>	<p>The following causes are possible. 1. Is a central remote controller or on/off controller also installed? <b>* The priority order of the operation codes depends on the central devices which are installed.</b> The below operation codes are set. • Schedule timer Central remote controller is used as well Operation code of the central remote controller • Schedule timer On/off controller is used as well Operation code of the on/off controller • Schedule timer Central remote controller On/off controller is used as well Operation code of the central remote controller</p>
<p>The unit operates even though that day is set as a holiday. (When using the unit with a central remote controller)</p>	<p>The following causes are possible. 1. Is another timer number set with the central remote controller set for "on" at the same time? (If two timer numbers are set, make sure that the settings for holidays and working days do not overlap between the different timer numbers.)</p>		





## 14.16 <KRCS01-4B> Remote Sensor

### Notes

- Please check applicable kit model name by catalog etc.
- When installed on SkyAir Round-flow type models, the dehumidification by detection of humidity does not operate.

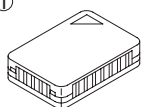
### Accessories

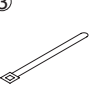
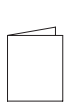
Check the following accessories.

Name	Remote sensor (sensor box)	Extension cable (2-core, 12m)	Clamp	Installation manual (this drawing)	Mounting screw (M4x16)
Shape	① 	② 	③ 	④ 	⑤ 
Quantity	x 1	x 1	x 2	x 1	x 2

### 1 Mounting

#### 1) Selection of mounting location.

The thermistor for temperature detection is incorporated into the remote sensor. Select the mounting location taking the following cautions into account.

- ① Where the average temperature of an air conditioned room can be detected.
- ② Where it is not exposed to the direct sunlight.
- ③ Where it is not influenced by other heat sources.
- ④ Where it is not exposed to the direct discharge air from the air conditioner.
- ⑤ Where it is not exposed to the outdoor air infiltrated into the room by opening the door.

#### 2) Mounting

- Remove the cover of the sensor box.

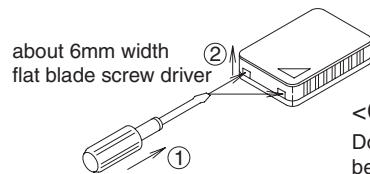

① Insert a flat blade screw driver into the sensor box concave part (2 locations).

② Remove the cover pushing up the nail to the cover of the sensor box.

#### <Cautions>

Do not push the nail powerfully with a narrow flat blade screw driver, because you may break off the nail.

(a) When mounting on the wall

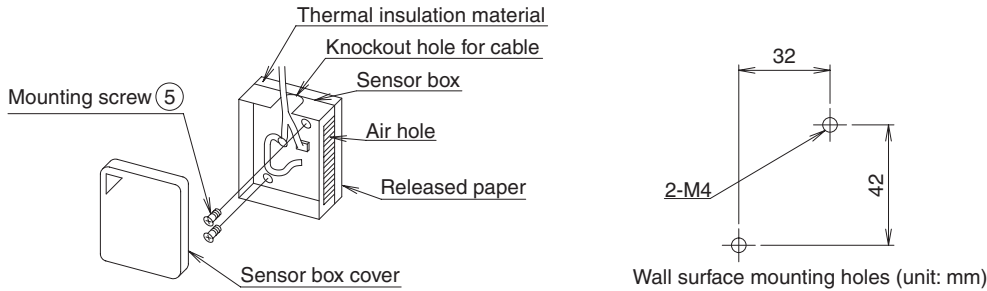

- Break open the knockout hole in the sensor box with a nipper or a similar tool. Pass the extension wires through the hole and fasten the wires to the terminals with screws.
- To avoid tensile force on the terminals, pass the attached clamp through the holes shown in the below right figure and tighten the extension cable with the attached clamp at the sheathed part. (The knot must come to the box inside.)

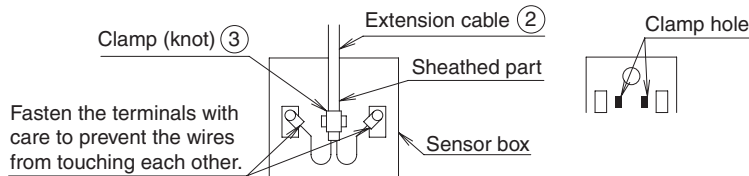

- Screw the sensor box securely to the wall surface with screws M4x16 (2 places).  
If the sensor box cannot be screwed to wall surface, tear off the released paper and mount it on the wall surface.

(b) For embedded wiring

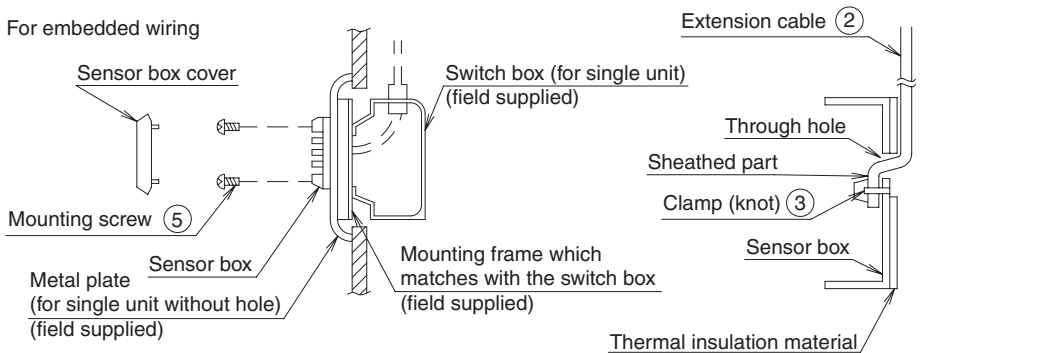

- Pass the extension cable through the switch box cable hole and carry out the wiring.
- Pass the attached clamp through the clamp holes and tighten the extension cable at the sheathed part as shown in the upper right figure.
- Tap M4 screw holes in the metal plate (field supplied) as shown in the right drawing and mount the switch box on the metal plate.

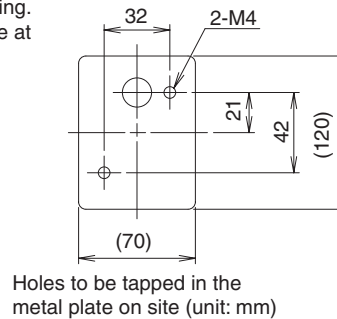

<Cautions>

- When wiring the extension cable, the air holes will not be blocked.
- When the extension cable is longer than necessary, cut it to the appropriate length, peel the insulation, attach the round crimp terminal for M3 (field supplied) and carry out the wiring. The length of insulation to be peeled off is as shown. (Work carefully so that the connector side may not be cut.)





## 2 Wiring method

Connect the extension cable connector side to the indoor unit PCB (printed circuit board)  
 For connection to the indoor unit, follow the procedure shown below.

### ⚠ Caution

- 1) Make sure to turn off the power supply before starting the wiring work and do not turn on until all the work is completed.  
 Read also the installation manual and the wiring diagram of the indoor unit when carrying out the work.
- 2) When wiring the extension cable, do not pass where the extension cable may be affected by the power line or noise.
- 3) Make sure to securely connect the connectors.  
 Defective connection may result in incorrect detection of room temperature or malfunction.
- 4) Do not splice wires.
- 5) Since the connector marking of the thermistor for detection of inlet air temperature differ depending on the indoor unit type, make sure to check the indoor unit wiring diagram and follow it correctly.
- 6) Lay and clamp the extension cable inside the indoor unit switch box just like the low voltage line (cord for remote controller).  
 And do not pass where the extension cable inside the indoor unit switch box may be affected by the power line (cord for the indoor unit and the other electric line).

#### <Procedure>

- 1) When wiring to the indoor unit PCB, remove the existing thermistor (for detection of inlet air temperature) and then connect the extension cable.  
 When doing this work, make sure to check the symbol of connecting address on the PCB whether it is correct or not referring to the wiring diagram.

<For SkyAir and VRV>

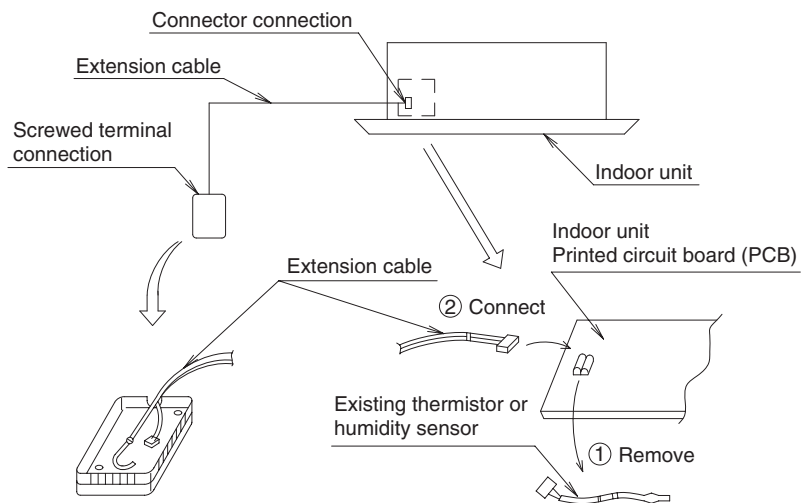

- 2) Lay and clamp the extension cable inside the indoor unit switch box just like the existing thermistor.  
 When doing this work, keep a certain distance between the high voltage wiring and the low voltage wiring to avoid error of sensor.  
 Provide protection of the existing cable for thermistor without affecting other components.
- 3) Fit the sensor box cover into the sensor box.

## 3 Operation test after mounting the sensor

Conduct cooling and heating operation test after the sensor is mounted and the wiring is completed.

## 14.17 <KRP1C74> Wiring Adaptor

### Accessories

Check if the following accessories are included in the kit.

Name	Adaptor for wiring	Harness	PCB support	Clamp	Installation manual
Shape					
Quantity	x1	x1	x4	x3	x1

### Notes

- Kits vary according to applicable models.
- A special adaptor fixing plate and box are required for the following models.  
FDMQ . . . KRP4A98

#### < Caution >

- All wiring must be performed by an authorized electrician.
- For electric wiring work, refer to also "Wiring diagram" attached to the control box lid and this manual.
- All wiring must be worked after shutting down power supply.
- All field supplied parts and materials and electric works must conform to local codes.
- A circuit breaker capable of shutting down power supply to the entire system must be installed.

## 1 Names of parts

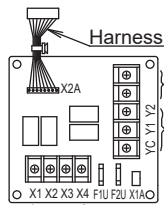

This function can not be used.  
Terminals for controlling auxiliary heater, humidifier, and other equipment.

Terminals for operation status

## 3 Installation

- Do not bundle low and high voltage wires together.
- Bundle any excess wires with the attached clamps so as to keep loose wires off the indoor unit PCB.

## 2 Electric wiring

- Refer to the wiring diagram attached to the indoor unit before attempting to wire.  
(Make sure wires to units do not pass over the PCB when wiring.)
- Wire the adaptor to the indoor unit as shown below.

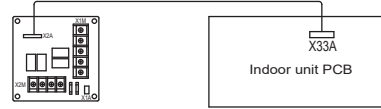

### ① Thermo-ON and Fan ON status

- Thermo-ON status  
Contact terminals X1 and X2 close while the indoor unit is Thermo-ON (call for cooling or heating)
- Fan ON status  
Contact terminals X3 and X4 close when indoor unit fan is ON

Example : Obtaining status

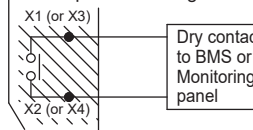

Example : Interlock

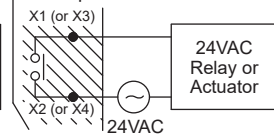

### ② Interlocking Humidifier and Heater

- Humidifier output (Y2-YC)
  - Energized while heating Thermo-ON (call for heating)
- Heater output (Y1-YC)
  - Auxiliary heater output with heat pump heating
  - Primary heater output when heat pump lockout enabled

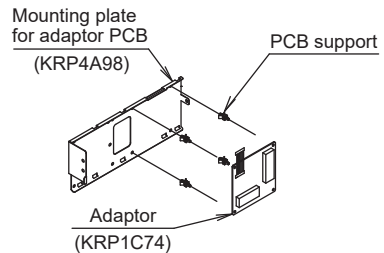
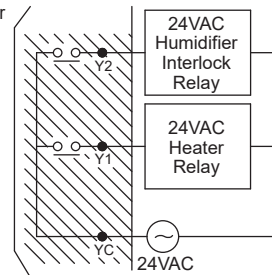

## 14.18 <KRP4A98> Installation Box for Adaptor PCB

### Precaution

- This is installable to the ceiling mounted duct type air conditioners and to the ceiling mounted cassette built-in type air conditioners.
- When mounting the adaptor plate, see also the indoor unit installation manual and the adaptor printed circuit board mounting instruction.
- Fixing method is not in the installation manual attached to the adaptor printed circuit board. Please follow directions on this sheet.

### Accessories

- Check if the following accessories are included with your kit.

#### <Precaution>

The accessories are required for the installation of the air conditioner. Be sure to keep them until the installation work is completed.

Name	adaptor plate(1)	adaptor plate(2)	Screws(1)	Screws(2)	Sealing material	Clamp	(Others)
Quantity	1PC.	1PC.	4PCS.	1PC.	2PCS.	10PCS.	Installation Manual
Shape							(This copy)

## 1 Mounting the adaptor plate

### <Wiring to the indoor unit>

- (1) Remove the control box lid. For built-in type, open the terminal block fixing plate. (The control box can be removed if it is hard to work.) [Fig. 1]
  - \* For terminal blocks for remote control wiring (X2M) or terminal blocks for power wiring (X1M) If wiring is required, refer to the installation instructions for the indoor unit, connect the wiring before, installing the adapter mounting plate. (In the case of duct type and back suction of built-in type.)
- (2) Connect the wiring attached to the adaptor printed board to the indoor unit. (The work is easier if the wiring is connected first.)
  - Refer to the instruction attached to the adaptor PCB for where to connect the wires.
  - Refer to Fig. 7 and 8. of **2 How to mount the adaptor printed circuit board and handle the wiring** for the connector location.

### <Mounting the adaptor plate>

- When installing the adapter mounting plate after completing the wiring to the indoor unit
  - (1) Fix the adaptor plate (2) to the control box with the attached screws (1) at 2 locations. [Fig. 2]
  - (2) Attach the adaptor plate (1) to the control box with the attached screw (1) and attach adaptor plate (1) and (2) to the control box with the attached screw (2). [Fig. 3]
- When wiring to the indoor unit after installing the adapter mounting plate
  - (1) Remove one of the mounting screws (1) on the adaptor mounting plate (2), and then loosen the mounting screws (1) on the adaptor mounting plate (1) and (2) respectively. [Fig. 4]
  - (2) Move the adaptor mounting plates (1) and (2), and wire the **2 How to mount the adaptor printed circuit board and handle the wiring** and Perform the wiring according to the installation instructions supplied with the indoor unit. After installation, move the adaptor mounting plates (1) and (2) and return them to their original positions. [Fig. 5]
  - (3) Follow the reverse procedure of (1), screwing the mounting screws (1) of the adapter mounting plate (2) in two places, and then screw the mounting screws (1) of the adapter mounting plate (1) in two places. [Fig. 4]

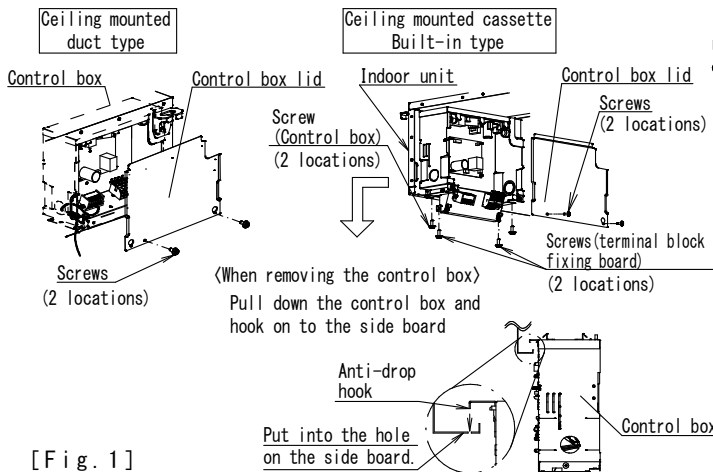
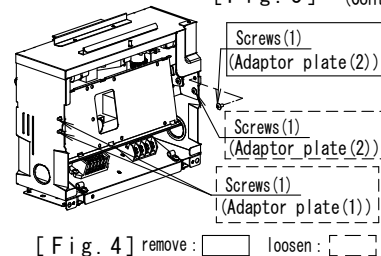
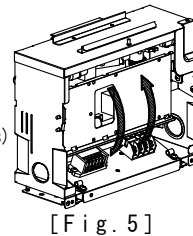
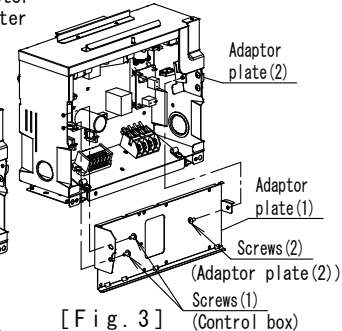
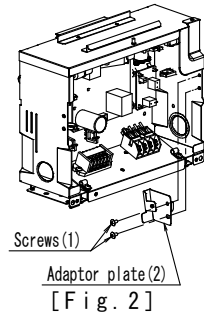

## 2 How to mount the adaptor printed circuit board and handle the wiring

### <How to lead-in external wires>

Lay the high-voltage and low-voltage wires in the control box separately through the wire inlet on the side of the control box. [Fig. 6]

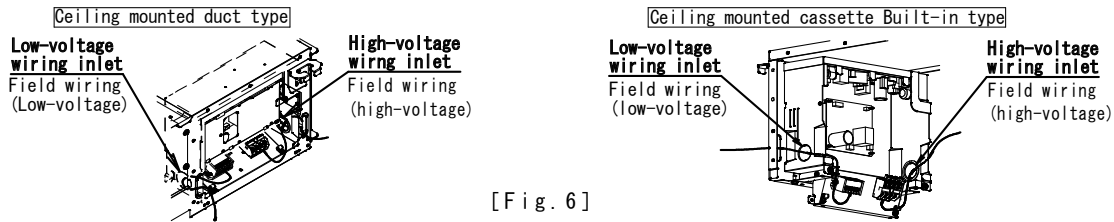

[ Fig. 6 ]

《How to mount the adaptor printed circuit board》

- Connect the wiring to the adaptor printed circuit board.  
(The work is easier if the wiring is connected to the printed circuit board first.)
  - See the instruction attached to the adaptor PCB for the connecting locations of wiring.
- Mount adaptor printed circuit board onto the adaptor plate in the direction as shown on Fig. 7 and 8.
  - Use printed circuit board supports attached to the adaptor PCB.

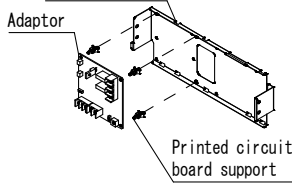

《Caution》 If adaptor PCB is mounted in a wrong direction, electric noise may cause malfunction of the system or may influence upon other devices.

Adaptor PCB	Location to mount
Adaptor plate for wiring	KRP1C64 [ Fig. 7 ]
Wiring adaptor for electrical appendices for group.	KRP4AA51 [ Fig. 7 ]
Wiring adaptor for electrical appendices(※1)	KRP2AA61 [ Fig. 7 ]
External control adaptor (※1)	DTA104A61 [ Fig. 8 ]

Adaptor(※1) Only one adaptor can be mounted.

《How to handle the wiring》

《Caution》 Do not make high-voltage and low-voltage wires run in parallel.  
Electric noise may cause malfunction of the system or may influence upon other devices.

- Fix the internal wiring. Fix the wiring to the adaptor plate with the attached clamps as shown on Fig. 7 and 8.  
(Put clamps through the corner holes to fix wires.)

- Attach the control box terminal block fixing board and control box lid and wrap the wire sealing material around the wires so as to block the wire through hole. [ Fig. 9 ]
  - Take precautions to prevent the wires from getting caught.
  - Fill in any gaps in the through holes with putty or insulation (Procured locally) to prevent small animals and insects from entering the unit from outside, which may cause short circuits in the control box.

⚠Warning

Trim and lay the wiring neatly and attach the control box lid securely.  
An electric shock or fire may result if the control box lid catches any wiring or the wires push up the lid.

- Fix the wiring fixture attached to the indoor unit with the wire fixing screws.  
Fix each wiring with the attached clamp materials. [ Fig. 9 ]
  - See the instruction attached to the indoor unit.

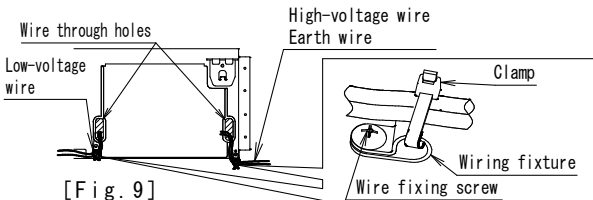

[ Fig. 9 ]

《Adaptor for wiring, Wiring adaptor for electrical appendices for group, Wiring adaptor for electrical appendices》

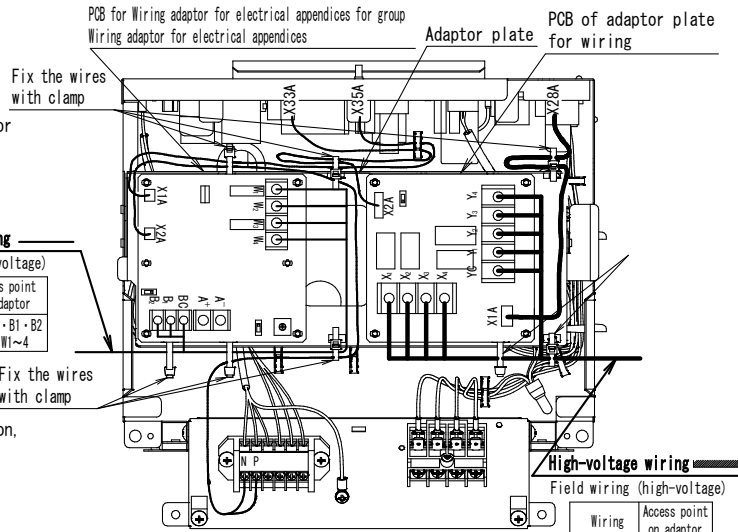

[ Fig. 7 ]

《External control adaptor》

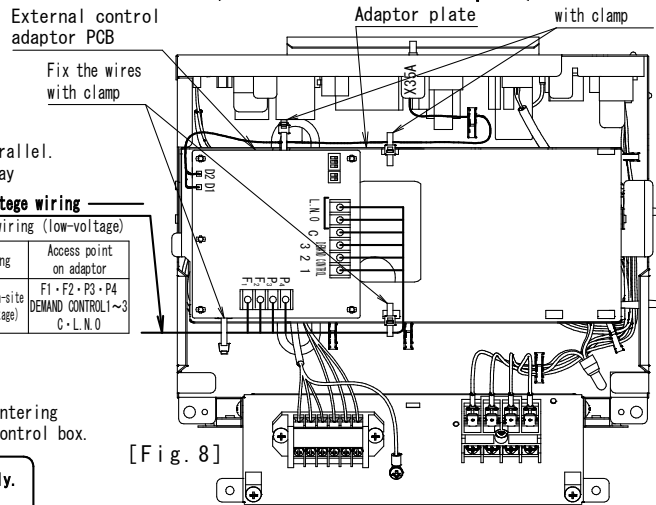

[ Fig. 8 ]



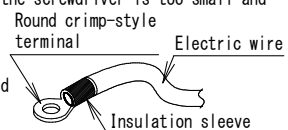

《Caution》

- Be sure to use round crimp-style terminal to connect to the terminal block. Provide insulation to the crimping part by attaching the insulation sleeve and such.
- Connect proper wires securely and fix the wires so that external force will not be imposed on the terminals.
- Use appropriate screwdriver to tighten the terminal screws. The screw heads may be damaged if the screwdriver is too small and terminal screws will not be tightend properly.
- Refer to the instruction attached to the indoor unit for the required tightening torque values of the terminal screws.



### 14.19 <KPW937F4> Air Direction Adjustment Grille

**Component parts** Be sure to check that the following parts are included before installation.

Name	①Air direction adjustment grille	②M4 × 3 O Screw	③Installation manual	④Seal	⑤Spacer
Shape					
Qty.	1 pc.	4 pcs.	3 sheets.	L=385: 1pc, L=355: 2pcs.	4 pcs.

**Selection of installation site**

- Use the air direction adjustment grille for installation at a location that fits the following conditions.
  1. When installing the outdoor unit near the neighbouring house.
  2. When changing the airflow direction to prevent exhaust blowing directly onto passersby or garden plants.

**Cautions for usage**

- Be sure to perform the following as installation precautions to ensure correct and safe use of the air direction adjustment grille.
  1. Be sure to stop the operation before installation.
  2. Avoid short-circuits during installation.
  3. When using the unit in areas with snow, install the grille to create a left-right or downward airflow. Do not install the grille to create an upward airflow to prevent snow accumulating in the air outlet of the outdoor unit as this may damage the unit.
  4. Be careful of foreign substances such as dead leaves, which may accumulate on the air outlet after installing the grille to create an upward airflow.
  5. Do not use screws other than those provided. Tighten the screws securely without any looseness.

**Installation of air direction adjustment grille**

- Pitch of the installation screws for the air direction adjustment grille(①) is 434mm in the vertical and horizontal directions.
- Installation can be performed in 4 directions: top, bottom, left and right.
- Temporarily secure the air direction adjustment grille(①) using 4 screws(②), check the installation angle, and then tighten the screws.

**Steel wire outlet grille**

- Seals(④) and spacers(⑤) are not necessary.
- 1 Remove the 4 outlet grille fixing screws.

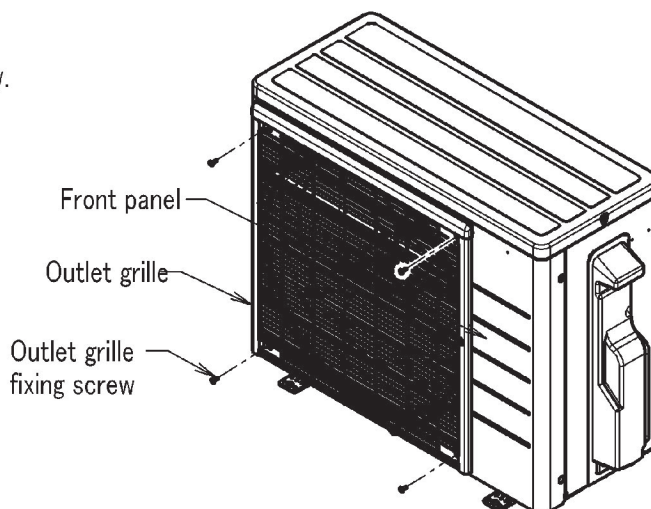



2 Install the air direction adjustment grille(1) attached on the front panel using 4 screws(2).

※ Attach the air direction adjustment grille on top of the outlet grille using the same screws.

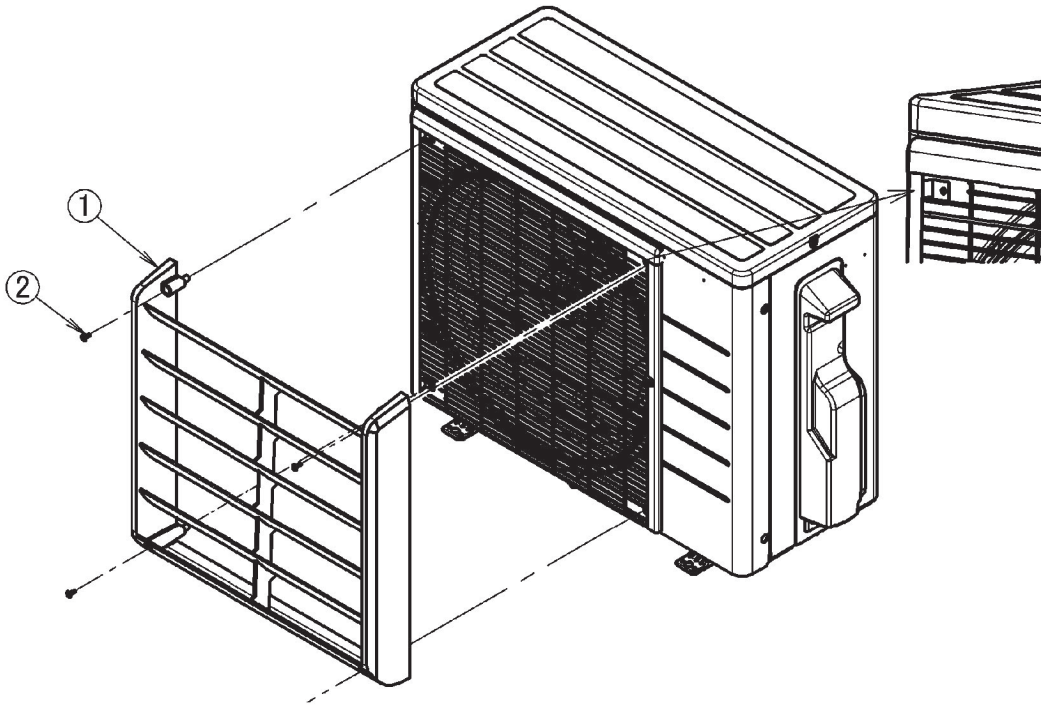



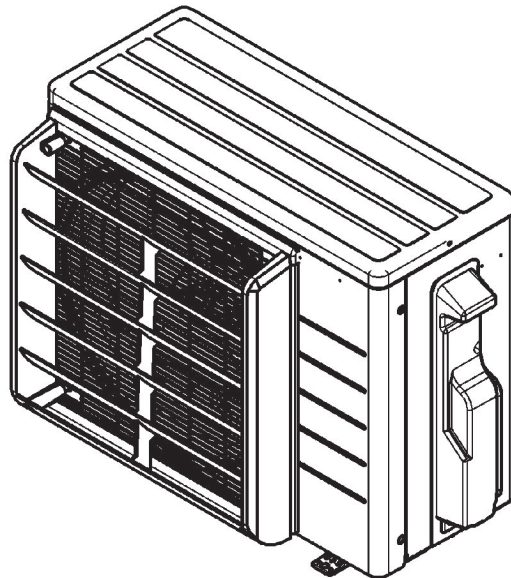

3 Appearance of the air direction adjustment panel following installation.  
(When installed with the louvers facing up.)

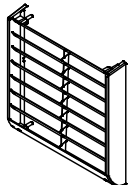

## 14.20 <KPW063B4> Air Direction Adjustment Grille

**Component parts** Be sure to check that the following parts are included before installation.

Component parts

Name	① Air direction adjustment grille	② Screw	③ Spacer	④ Installation Manual
Illustration				
Quantity	1 pcs.	4 pcs.	4 pcs.	1 sheet (this sheet)

**Selection of installation site**

Install only on an outdoor unit in a location that satisfies the following conditions:

- When installing the outdoor unit near the neighbouring house.
- Where you wish to change the exhaust airflow direction because the outdoor unit has been installed facing a road, so that passing people are not exposed to its exhaust air
- When changing the airflow direction to prevent exhaust blowing directly onto passersby or garden plants.

**Cautions for usage**

- Be sure to perform the following as installation precautions to ensure correct and safe use of the air direction adjustment grille.
  1. Install the product so that it is situated high enough to allow access to the outdoor unit for maintenance purposes.
  2. When installing the product in a location in which it may be exposed to strong winds, install a rollover prevention bracket (sold separately) at the same time.
  3. Tighten screws securely. Failure to do so may result in vibration.

**1 Verifying the amount of space required for installation**

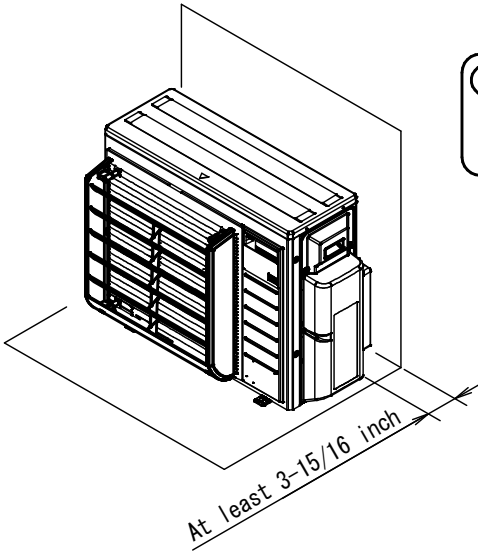

**⚠ Caution**

Leave at least 3-15/16 inch between the rear of the outdoor unit and any obstructions (walls, etc.).

2 Installation of air direction adjustment grille

**⚠ Caution**

Install the air direction adjustment grille on top of the outlet grille.  
 Be sure to install the outlet grille as installing only the air direction adjustment grille would allow a person to reach his or her hand into the outdoor unit far enough to come into contact with the rotating fan.

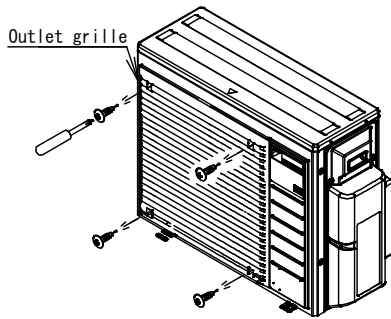

- (1) Remove the 4 outlet grille fixing screws.
  - (2) Referring to the following illustration, attach the outlet grille and air direction adjustment grille, taking care to align them with the air outlet direction.
- Attach the air direction adjustment grille on top of the outlet grille using the same screws.

Upward facing

Downward facing

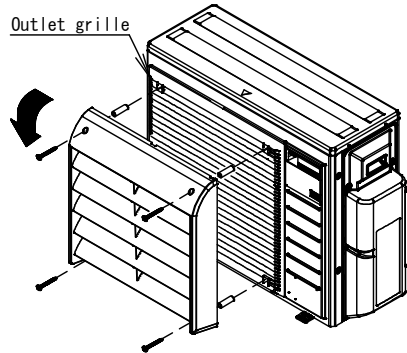
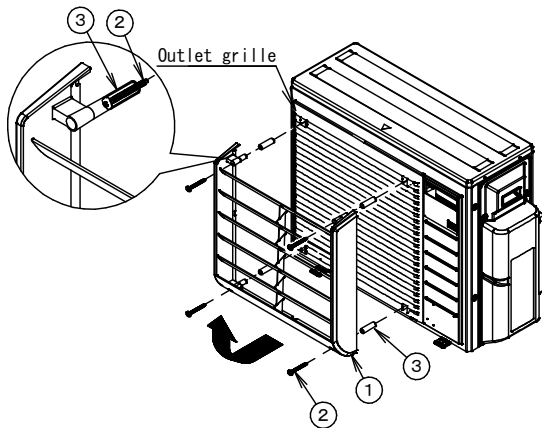

Appearance of the air direction adjustment grille after installation (when installed with the louvers facing up)

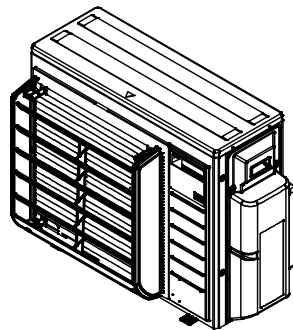



### 14.21 <KKG067A41> Back Protection Wire Net

**Component parts**

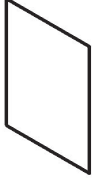
Name	① Protection net	② Installation manual
Shape		
Q'ty	1pc	1sheet (this sheet)

**Caution**

Be sure to wear protection gloves when performing installation work as the fins on the heat exchanger may cause injury.

**Part names**

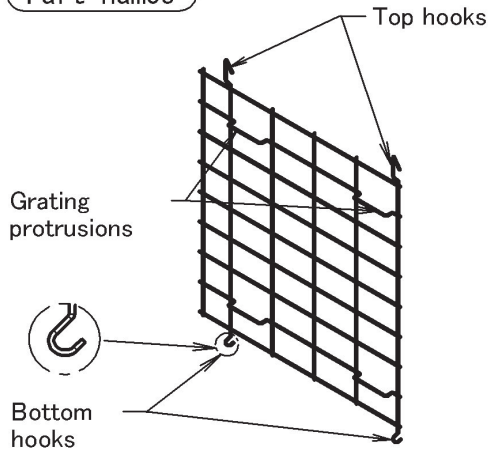

**1** Verify the location at which the protection net (①) is to be installed.

Attach the protection net (①) so that the vertical grating is aligned with the outside edge of the installation leg on the right side of the outdoor unit.

Positioning line when installing the protection net (①)

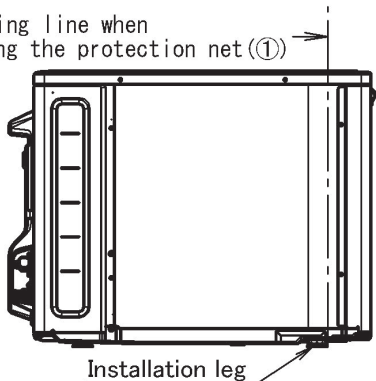

**2** Attach the protection net (①)

Orient the protection net (①) so that the horizontal grating protrusions are facing the heat exchanger and insert the two bottom hooks between the heat exchanger and the bottom frame. Insert the two top hooks between the heat exchanger and the top panel while flexing the protection net (①).  
 ※ Be careful not to install the protection net upside down.  
 Be careful not to damage the heat exchanger's cooling tubes.

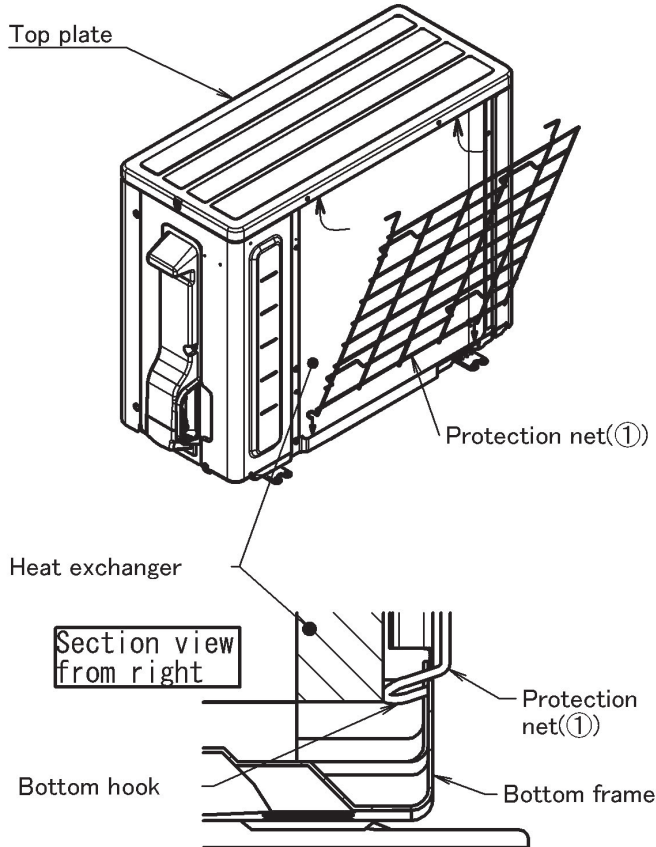

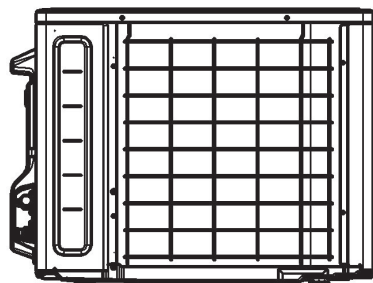

**3** Appearance of the protection net (①) following installation



### 14.22 <KKG063A42> Back Protection Wire Net

#### Component parts

Name	① Protection net	② Installation manual
Shape		
Q'ty	1pc.	1sheet (this sheet)

#### Caution

Be sure to wear protection gloves when performing installation work as the fins on the heat exchanger may cause injury.

#### Part names

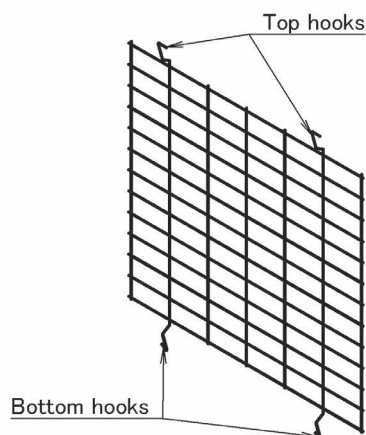

#### 2 Attach the protection net (①)

Orient the protection net (①) so that top and bottom hooks are facing the heat exchanger and insert the two bottom hooks between the heat exchanger and the bottom frame.

Insert the two top hooks between the heat exchanger and the top panel while flexing the protection net (①).

※ Be careful not to damage the heat exchanger's cooling tubes.

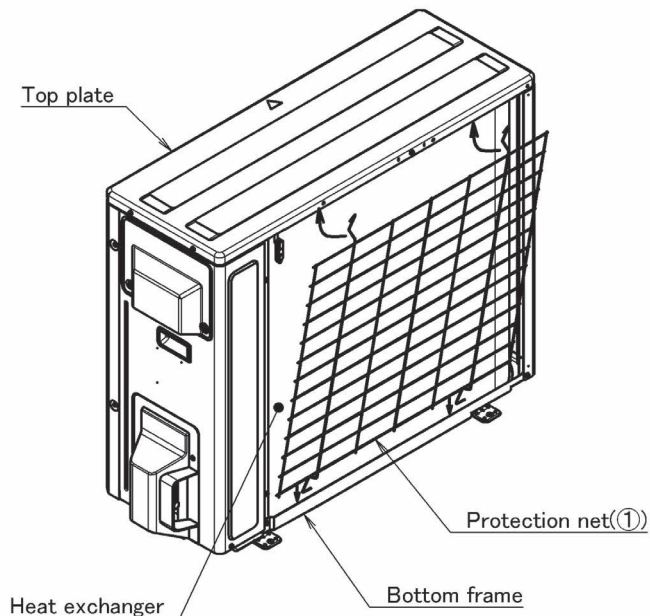

#### 1 Verify the location at which the protection net (①) is to be installed.

Attach the protection net (①) so that the vertical grating is aligned with the edge of the installation leg on the right side of the outdoor unit.

Positioning line when installing the protection net (①)

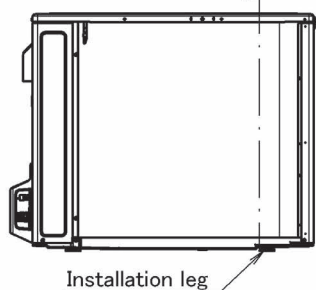

#### 3 Appearance of the protection net (①) following installation

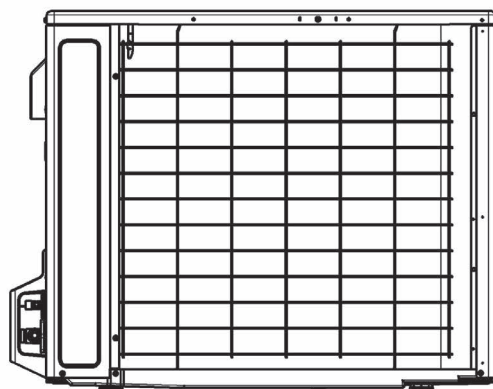



## 14.23 <KEH067A41EA, KEH063A4E, FTDBHMS, FTDBHML> Drain Pan Heater

### Safety Considerations for Installation of Drain Pan Heater

Read these **Safety Considerations** carefully before installing the drain pan heater. After completing the installation, check if the unit operates properly during the start-up operation.

Meaning of **DANGER**, **WARNING** and **CAUTION** symbols.

 <b>DANGER</b>	Indicates an imminently hazardous situation which, if not avoided, will result in death or serious injury.	 <b>CAUTION</b>	Indicates a potentially hazardous situation which, if not avoided, may result in minor or moderate injury. It may also be used to alert against unsafe practices.
 <b>WARNING</b>	Indicates a potentially hazardous situation which, if not avoided, could result in death or serious injury.		

- Inform users that they should store this installation manual for future reference.
- After completing the installation, make sure that the unit operates properly during the startup operation.
- All phases of the field-installation, including, but not limited to, electrical, piping, and safety, must be done in accordance with manufacturer's instructions and must comply with national, state, provincial, and local codes.
- This product is a heater designed to melt snow that is blown into the product from the outside to prevent the drain pan of the outdoor unit from freezing.
- Install the product with a snow-break hood on a high stand if this product is used in heavy snow areas.

#### **DANGER**

- **Do not touch the heater unit without wearing gloves.**  
The temperature of the heater unit will become high when the heater is turned on. Touching the heater unit with bare hands will result in burns or injury.

#### **WARNING**

- **Request the dealer or an authorized technician to install the product.**  
Improper installation of the product could result in water leakage, an electric shock, or fire.
- **The product must be installed according to the instructions given in this manual.**  
The incomplete installation of the product could result in water leakage, an electric shock, or fire.
- **Use the supplied or specified installation parts.**  
Use of other parts could result in the unit becoming loose and falling, water leakage, electric shock, or fire.
- **Turn off the power supply at the time of installation.**  
Touching any electrical parts may with the power supply turned on could result in electric shock.
- **Use specified wires. Connect and fix the wires so that the wires will not put improper force on the terminal junctions.**  
Wires connected or fixed improperly could result in terminal overheating, an electric shock, or fire.
- **When wiring and connecting the indoor and outdoor units, carefully arrange the wiring so that they will not put improper force on the structures.**  
Install covers over the wires. Incomplete cover installation could result in terminal overheating, an electric shock, or fire.

#### **CAUTION**

- **Wear protective gloves at the time of installation.**  
Touching the suction mouth or aluminum fin of the outdoor unit may result in injury.
- **Do not install the product in places where there is danger of exposure to inflammable gas leakage.**  
If the gas leaks and builds up around the unit, it may catch fire.
- **Do not grab the top plate of the outdoor unit carelessly when removing the top plate.**  
The sharp edge of the top plate may cause injury.
- **Do not install the outdoor unit in places where small animals may nest in the outdoor unit.**  
If small animals intrude and touch the internal parts of the outdoor unit, the outdoor unit may malfunction, generate smoke, or ignite. Advise the user to keep the place clean.
- **Do not touch the heater unit with bare hands.**  
The temperature of the heater unit will become high when the heater is turned on. Touching the heater unit with bare hands may result in burns or injury.

## Accessories

		KEH067A41E FTDBHMS	KEH063A4E FTDBHML			KEH067A41E FTDBHMS	KEH063A4E FTDBHML
Ⓐ	Drain pan heater 	1	1	Ⓔ	Installation manual (multi-language) 	1	1
Ⓑ	M4 piercing screw 	3	6	Ⓕ	Electric wiring diagram label 	1	1
Ⓒ	Binding band 	1	1	Ⓖ	Information label 	1	1
Ⓓ	Sealing material 	1	2	Appearance of the Ⓐ drain pan heater may differ from some models.			

## Tools Required for Installation

- Electric drill
- $\phi 1/8$  inch ( $\phi 3.2$ mm) drill
- Phillips screwdriver
- Nippers

## Installation Procedure (1)

### ⚠ WARNING

- Be sure to check that the power supply of the product is turned off.

Some stages in the installation procedure differ by model of outdoor unit. Refer to the instructions for the relevant model.

**Type A models** : RX09/12, RXN09/12, RXL09/12

**Type B models** : RX15/18/24, RXN18/24, RXL15

**Type C models** : 2/3/4MXS, 2/3MXL, RX30/36

### 1. Remove each component of the outdoor unit.

- 1) Remove the top plate.
- 2) Affix the Ⓕ electric wiring diagram label where there is enough wiring space available on the back of the top plate.
- 3) Remove the screws from the protective wire mesh if one is fitted. (2 screws)  
(For type B and C models only)
- 4) Remove the front plate.
- 5) Remove the anti-drip cover.  
(For type B and C models only)
- 6) Affix the Ⓖ information label near the manufacturer's label.

- The appearance of the outdoor unit and the number of screws may differ from some models.
- Screw types for each component are indicated as below.

No icon: Hexagon tapping screw

△ : Truss head tapping screw

#### For type A models

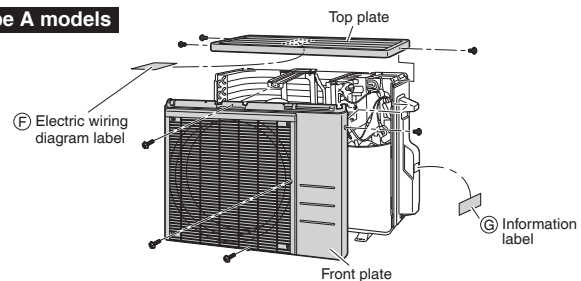

#### For type B and C models

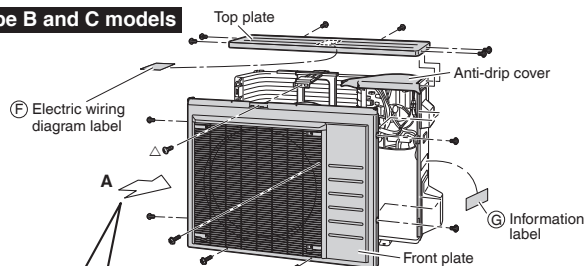

#### View A

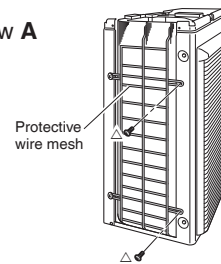

## Installation Procedure (2)

### 2. Remove the fan motor base.

- 1) Remove the fixing screws at the lower section of the fan motor base. (2 screws)
- 2) Remove the fan motor base together with the propeller fan and ensure that stress is not placed on the propeller fan when placing them aside.
  - Do not remove the fan motor harness.
  - Ensure that the fan motor harness does not come into contact with the edges of the heat exchanger or other components.

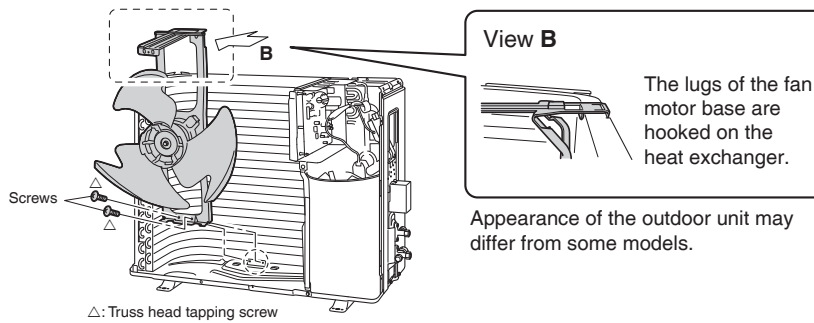

**View B**

The lugs of the fan motor base are hooked on the heat exchanger.

Appearance of the outdoor unit may differ from some models.

### 3. Install the drain pan heater.

**⚠ CAUTION**

- When drilling a hole, be careful not to damage the soundproofing material and other components on the back side.

For details, refer to “**Installation Procedure (3)**” also.

- 1) Remove 1 screw from the bottom frame so that the plates of the (A) drain pan heater can be inserted under the heat exchanger with ease.
- 2) Lift up the heat exchanger, and insert the plates of the (A) drain pan heater under the heat exchanger.
  - The ground plate of the (A) drain pan heater should be installed so that, in type A models, it firmly adheres to the bottom frame and, in type B and C models, it firmly adheres to the partition plate.
  - Install the (A) drain pan heater in a position where it does not come into contact with the fan motor base.
- 3) If there are no holes, drill  $\phi 1/8$  inch ( $\phi 3.2$ mm) holes in the bottom frame and the partition plate to fix the (A) drain pan heater.
  - Place the actual components to ensure positioning is correct before drilling holes.
  - The holes can be made with the included piercing-screw as well.
- 4) Fix the (A) drain pan heater with the (B) piercing screws.
- 5) Reattach the screw that was removed from the bottom frame.

## Installation Procedure (3)

### For type A models

Location and number of holes  
Bottom frame: 2

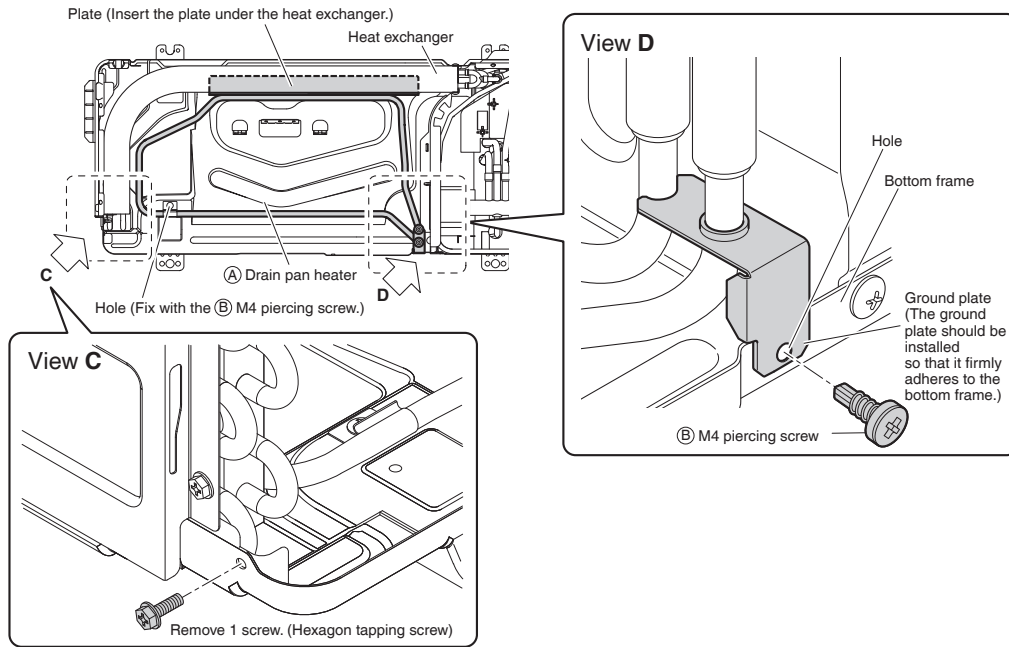

### For type B and C models

Location and number of holes  
Bottom frame: 1  
Partition plate: 2

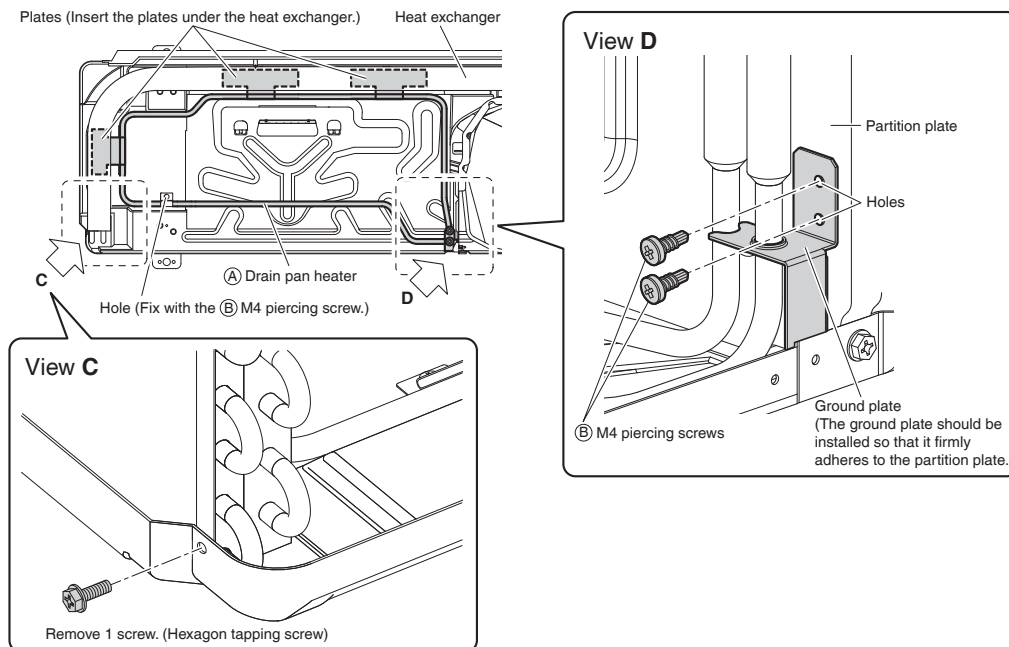



## Installation Procedure (4)

### 4. Route the harnesses.

**⚠ WARNING**

- When drilling a hole, be careful not to damage the soundproofing material and other components on the back side.

**For type A models**

- 1) If there is no hole, drill a  $\phi 1/8$  inch ( $\phi 3.2\text{mm}$ ) hole in the partition plate. (1 location)
- 2) Fix in place the binding band attached to the (A) drain pan heater harness by screwing the (B) M4 piercing screw into the hole. (1 location)
- 3) Install the fan motor base.
  - Be careful not to confuse screw types. Refer to “Installation Procedure (2)”.
- 4) Place the (A) drain pan heater harness on top of the fan motor harness, and fix it in place with the (D) sealing material.

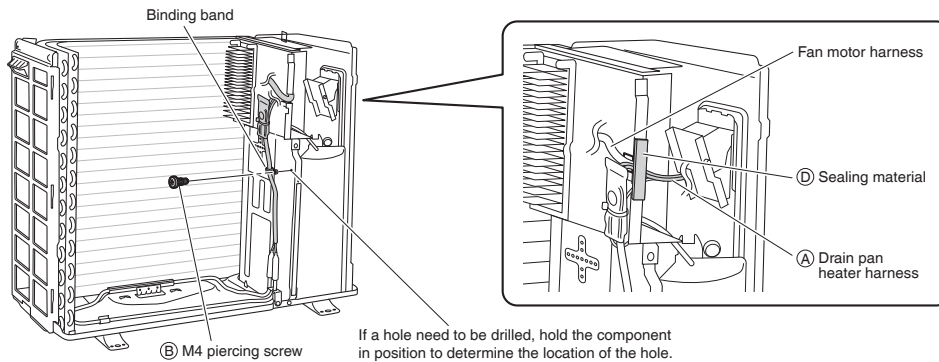

**For type B and C models**

- 1) If there are no holes, drill  $\phi 1/8$  inch ( $\phi 3.2\text{mm}$ ) holes in the partition plate. (3 locations)
- 2) Fix the (A) drain pan heater harness in place by screwing the (B) M4 piercing screws into the holes. (3 locations)
- 3) Install the fan motor base.
  - Be careful not to confuse screw types. Refer to “Installation Procedure (2)”.
- 4) Trim the electrical wiring box with nippers at the locations shown in the figures, then cover the trimmed edges with the (D) sealing material.
- 5) Insert the (A) drain pan heater harness into the space that was trimmed, and fix it in place using the (D) sealing material.

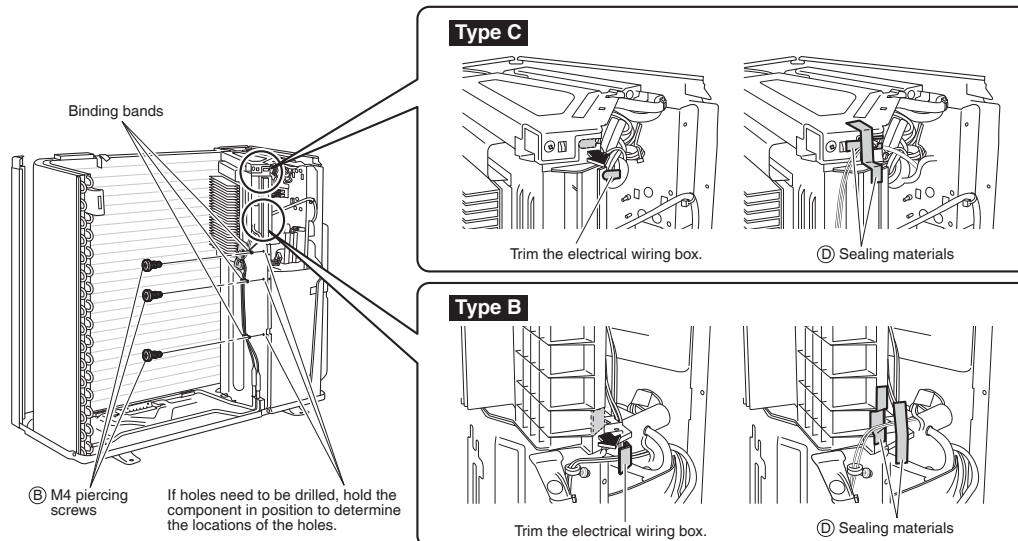

## Installation Procedure (5)

### 5. Connect the faston terminals of the drain pan heater to the terminal block of the outdoor unit.

- 1) Connect the thermostat-side terminal (black harness) to the leftmost terminal and the heater-side terminal (white harness) to the second leftmost terminal.
  - For type C models, connect to the last terminal block of the terminal blocks in use.
- 2) Bundle the (A) drain pan heater harness so that there is no slack, and secure it with the (C) binding band. (1 location)
  - Cut the tip of the (C) binding band.

#### For type A models

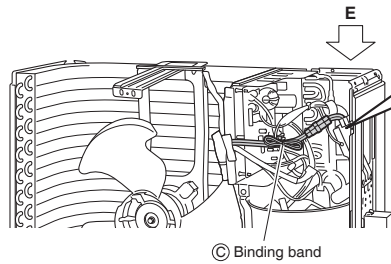

#### View E

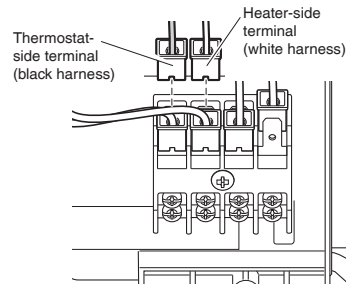

#### For type B models

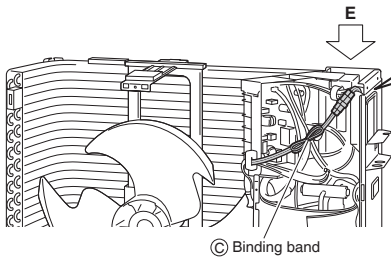

#### View E

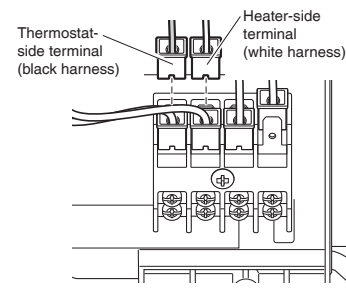

#### For type C models

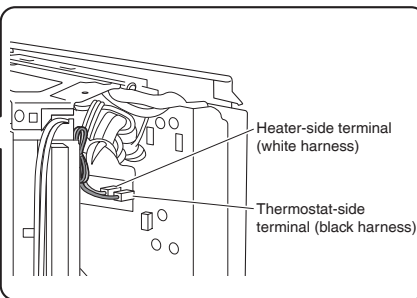
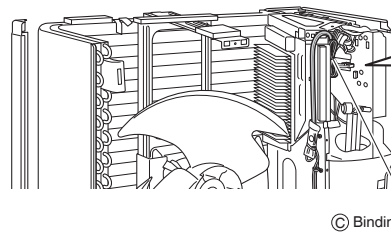

### 6. Install each component to the original position.

- Be careful not to confuse screw types. Refer to "Installation Procedure (1)".
  - 1) Install the front plate.
  - 2) Install the anti-drip cover.
    - (For type B and C models only)
  - 3) Install the top plate.



### 14.24 <KPS067A41> Snow Hood (Intake Side Plate)

**Parts** Before assembling the product, verify that all of the following parts have been included:

Name	Side plate (left)	Side plate (right)	Top plate	Front plate	Screws	Piercing screw	Installation Manual
Illustration							
Quantity	1	1	1	1	8	1	1 (this document)

**Caution** Read these safety considerations for installation carefully before installing the product.

- Be sure to observe the following installation precautions to ensure that the product can be used safely:
  1. Install the product so that it is situated high enough to allow access to the outdoor unit for maintenance.
  2. Installing the product in a location in which it may be exposed to strong winds, secure the outdoor unit with wire or other means.
  3. Choose a location where the operating sound will not cause a nuisance to the neighbors of the user.
  4. Tighten screws securely. Failure to do so may result in vibration.

**Caution** . . . . . Indicates a potentially hazardous situation which, if not avoided, may result in minor or moderate injury. It may also be used to alert against unsafe practices.

#### 1 Installing the snow hood (intake side plate)

**1 Attach the side plate (left) ①**

1. Remove the two screws (marked "☆1" in the figure) that hold the outdoor unit's top plate, bottom frame, and front plate in place and use them to attach the side plate (left) ①.

**When using with KPS067A42 (snow hood [intake rear plate])**

Intake rear plate (left)

Attach the side plate (left) ① along with the intake rear plate (left) using the same screws, with the side plate (left) ① positioned above the intake rear plate (left). Refer to the figure to the left.

**2 Attach the side plate (right) ②**

1. Remove the screw (marked "☆2" in the figure) that hold the outdoor unit's top plate, and front plate in place and Use the ⑥ piercing screws supplied with the screws and kit that were removed, install a side plate (right) ②.

**3 Attach the top plate ③ and front plate ④.**

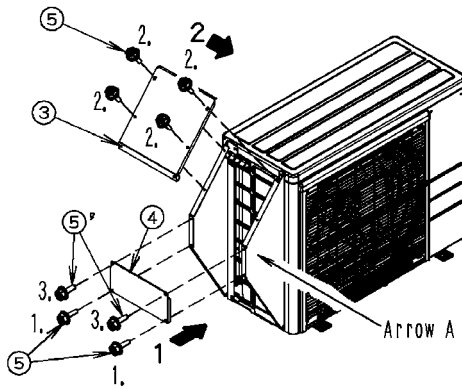

1. Aligning the creases on the left and right sides of the front plate ④ with the outer surfaces of the side plate (left) ① and the side plate (right) ②, temporarily secure the front plate ④ in place with the 2 screws ⑤.
2. Temporarily secure the top plate ③ from above the front plate ④ with the 4 screws ⑤.
3. Temporarily secure the top plate ③ and the front plate ④ with the 2 screws ⑤'. (See arrow A.)

\*The side plate (left) (1), side plate (right) ②, top plate ③, and front plate ④ should be positioned as shown in the following figure:

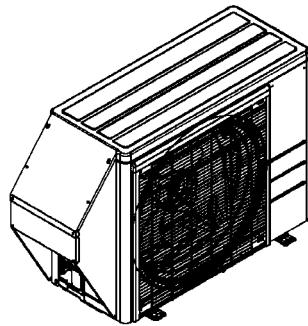
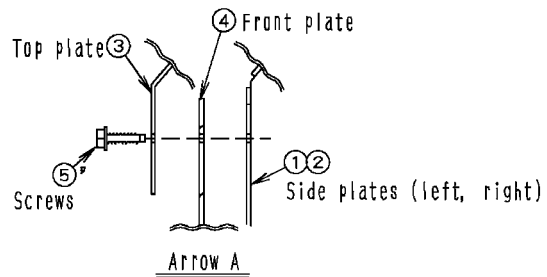

4. Securely tighten the 8 screws ⑤ with which the plates were temporarily secured in steps 1), 2), and 3).

**2 Appearance of the snow hood (intake side plate) following installation**

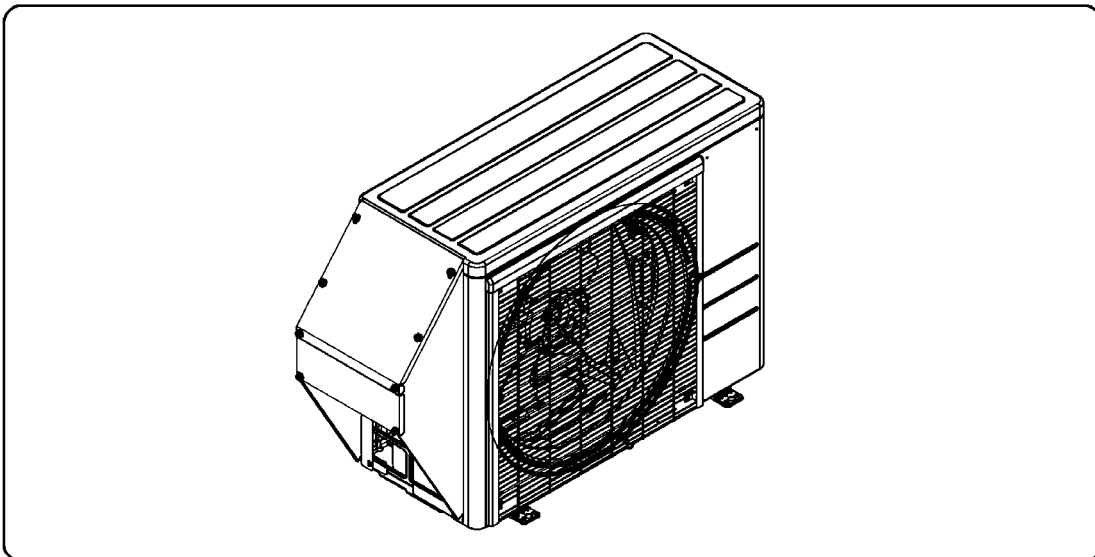

### 14.25 <KPS067A42> Snow Hood (Intake Rear Plate)

**Parts** Before assembling the product, verify that all of the following parts have been included:

Name	Side plate (Left)	Side plate (Right)	Top plate	Front plate	Screws	Piercing screw	Installation Manual
Illustration							
Quantity	1	1	1	1	8	2	1 (this document)

**Caution** Read these safety considerations for installation carefully before installing the product.

- Be sure to observe the following installation precautions to ensure that the product can be used safely:
  1. Install the product so that it is situated high enough to allow access to the outdoor unit for maintenance.
  2. Installing the product in a location in which it may be exposed to strong winds, secure the outdoor unit with wire or other means.
  3. Choose a location where the operating sound will not cause a nuisance to the neighbors of the user.
  4. Tighten screws securely. Failure to do so may result in vibration.

**Caution** . . . . . Indicates a potentially hazardous situation which, if not avoided, may result in minor or moderate injury. It may also be used to alert against unsafe practises.

#### 1 Installing the snow hood (intake rear plate)

##### 1 Attach the side panel (left) ①.

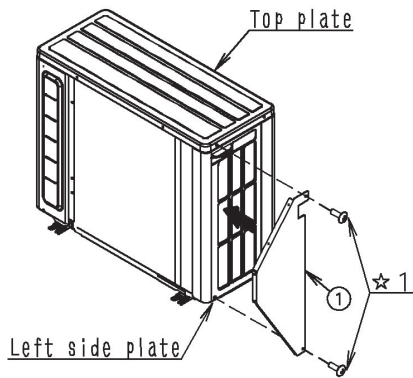

1. Remove the 2 screws (marked "☆1" in the figure) that hold the outdoor unit's top plate, left side plate, and bottom frame and use them to attach the side plate (left) ①.

**\*When using with KPS067A41 (snow hood [intake side plate])**

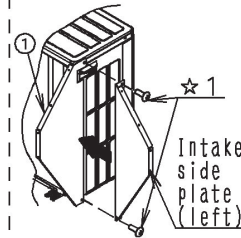

Attach the side plate (left) ① along with **the intake side plate (left)** using the same screws, with the side plate (left) ① positioned below the intake side plate (left). Refer to the figure to the left.

##### 2 Attach the side plate (right) ②.

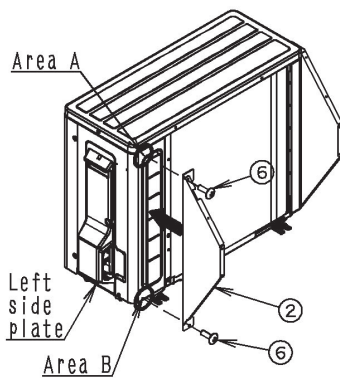

1. Attach by tightening the 1 piercing screw ⑥ into the dowel hole in the right side plate (area A) and the 1 piercing screw ⑥ into the screw hole in the bottom frame (area B).

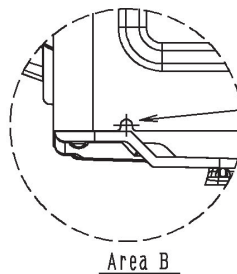

**\*If using an electric screwdriver, be careful not to overtighten the screws.**  
The fixed location

**3 Attach the top plate ③ and the front plate ④.**

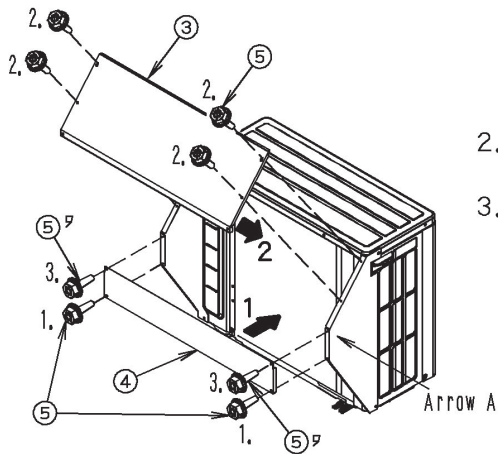

1. Aligning the creases on the left and right sides of the front plate ④ with the outer surfaces of the side plate (left) ① and side plate (right) ②, temporarily secure the front plate ④ in place with the 2 screws ⑤.
2. Temporarily secure the top plate ③ from above the front plate ④ with the 4 screws ⑤.
3. Temporarily secure the top plate ③ and the front plate ④ with the 2 screws ⑤'. (See arrow A.)

※The side plate (left) (1), side plate (right) ②, top plate ③, and front plate ④ should be positioned as shown in the following figure:

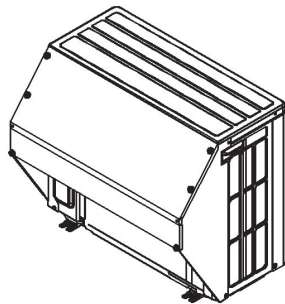
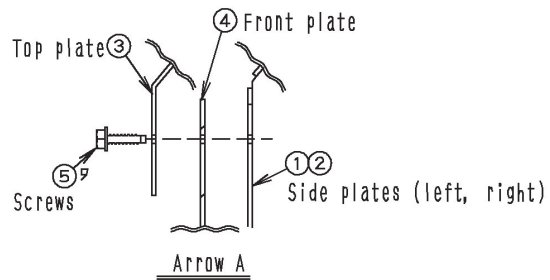



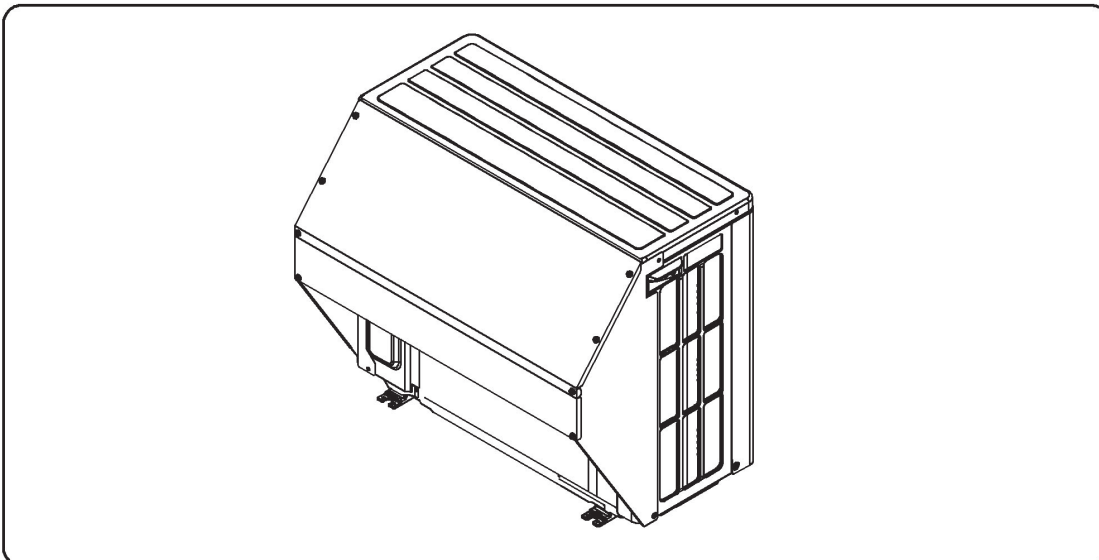

4. Securely tighten the 8 screws ⑤ with which the plates were temporarily secured in steps 1), 2), and 3).

**2 Appearance of the snow hood (intake rear plate) following installation**

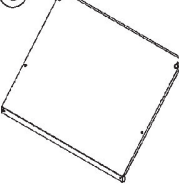

### 14.26 <KPS067A44> Snow Hood (Outlet)

**Parts** Before assembling the product, verify that all of the following parts have been included:

Name	Side plate	Side plate	Top plate	Screws	Installation Manual
Illustration	① (Right) 	② (Left) 	③ 	④ 	⑤ 
Quantity	1	1	1	6	1 (this document)

**⚠ Caution** Read these safety considerations for installation carefully before installing the product.

- Be sure to observe the following installation precautions to ensure that the product can be used safely:
  1. Install the product so that it is situated high enough to allow access to the outdoor unit for maintenance.
  2. Installing the product in a location in which it may be exposed to strong winds, secure the outdoor unit with wire or other means.
  3. Choose a location where the operating sound will not cause a nuisance to the neighbors of the user.
  4. Tighten screws securely. Failure to do so may result in vibration.

**⚠ Caution . . . .** Indicates a potentially hazardous situation which, if not avoided, may result in minor or moderate injury. It may also be used to alert against unsafe practices.

#### 1 Installing the snow hood (outlet)

**1** Remove the discharge grille,

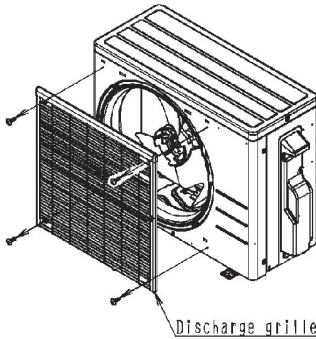

1. Remove the 4 screws that hold the discharge grille, then remove the discharge grille.

**2 Attach the side plate (left) ② and side plate (right) ①.**

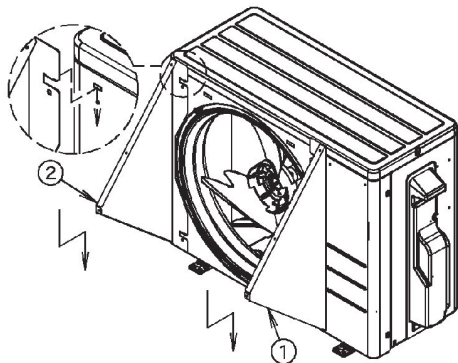

1. Insert the hooks in the side plate (right) ① and side plate (left) ② respectively into the holes provided in the front plate.

**3 Attach the discharge grille.**

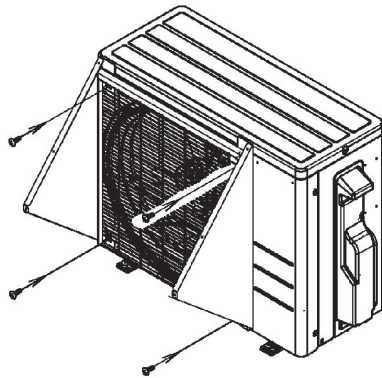

1. When installing the discharge grille removed in [1], jointly tighten the side plate (right) ① and side plate (left) ② with the 2 screws that hold the discharge grille for each plate.

**4 Attach the top plate ③**

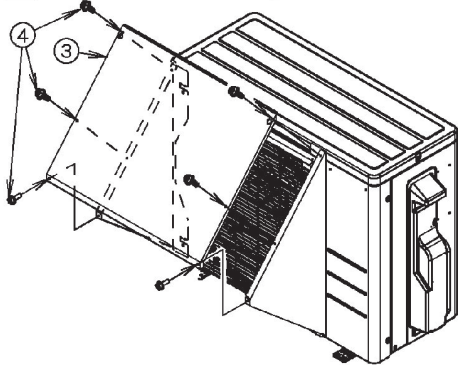

1. Install the top plate ③ using the 6 screws ④ included in the kit.

• Installation is easiest if you start with the hook slot.

**2 Appearance of the snow hood (outlet) after installation**

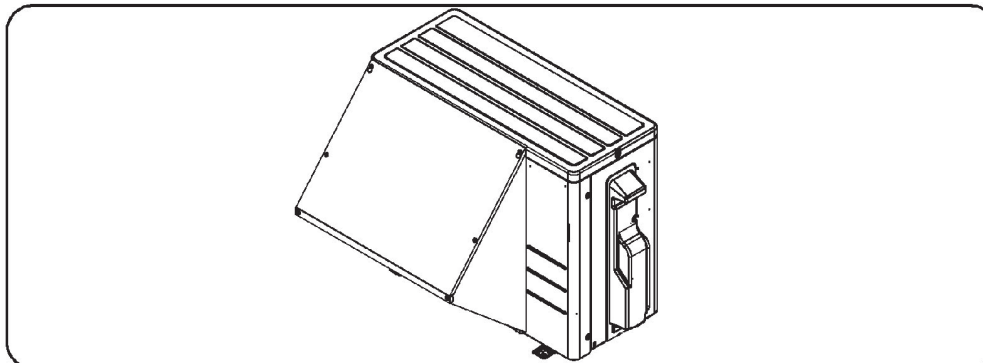



### 14.27 <KPS063A41> Snow Hood (Intake Side Plate)

**Parts** Before assembling the product, verify that all of the following parts have been included:

Name	Side plate (right)	Side plate (left)	Top plate	Front plate	Screws	Installation Manual
Illustration	①	②	③	④	⑤ (quantity to use 14)	⑥
Quantity	1	1	1	1	16	1 (this document)

**⚠ Caution** Read these safety considerations for installation carefully before installing the product.

● Be sure to observe the following installation precautions to ensure that the product can be used safely:  
 1. Install the product so that it is situated high enough to allow access to the outdoor unit for maintenance.  
 2. Installing the product in a location in which it may be exposed to strong winds, secure the outdoor unit with wire or other means.  
 3. Choose a location where the operating sound will not cause a nuisance to the neighbors of the user.  
 4. Tighten screws securely. Failure to do so may result in vibration.

**⚠ Caution . . . .**  
 Indicates a potentially hazardous situation which, if not avoided, may result in minor or moderate injury. It may also be used to alert against unsafe practises.

#### 1 Installing the snow hood (intake side plate)

**1** Remove the protective wire mesh

- Remove the 2 screws that hold the protective wire mesh.
- Remove the 6 screws that hold the top plate and remove the top plate.
- Remove the protective wire mesh, being careful of the part that is attached to the heat exchanger.
- Attach the top plate removed in step 2 using the 6 screws removed in step 2.

**2** Attach the side plate (right) ①

- Install the side plate (right) ① with the 2 screws that were used in the protective wire mesh that was removed in step 1.

- Use the second hook slot from the top and the 2 screw hole from the bottom.
- Installation is easiest if you start with the hook slot.

**3** Attach the side plate (left) **2**.

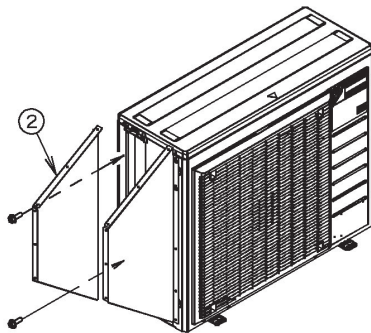

1. Install the side plate (left) **2** with the 2 screws that were used in the protective wire mesh that was removed in step **1**.

- Use the second hook slot from the top and the 2 screw hole from the bottom.
- Installation is easiest if you start with the hook slot.

**4** Attach the front plate **4**.

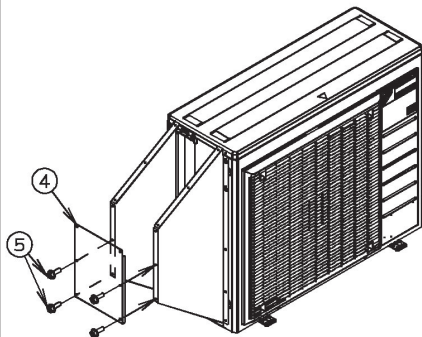

1. Temporarily secure the front plate **4** in place with the 4 screws **5**.

**5** Attach the top plate **3**.

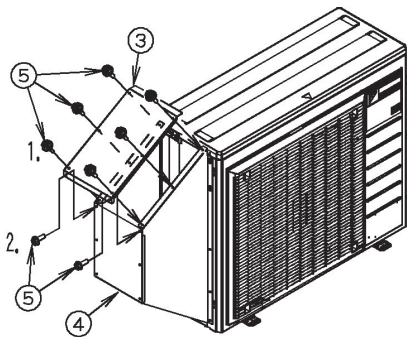

1. Attach the top plate **3** with the 6 screws **5**.
2. Temporarily secure the top plate **3** and the front plate **4** to the side plate (right) **1** and the side plate (left) **2** with the 2 screws **5**.
3. Tighten the 12 screws **5** that you used to temporarily secure parts in steps **4** and **5**.

**2** Appearance of the snow hood (intake side plate) after installation

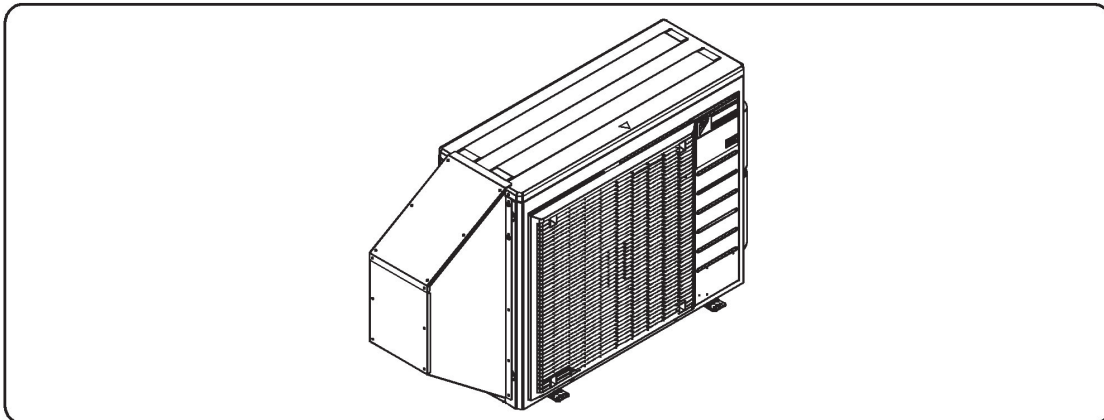



### 14.28 <KPS063A44> Snow Hood (Intake Rear Plate)

**Parts** Before assembling the product, verify that all of the following parts have been included:

Name	Side plate (Right)	Side plate (Left)	Top plate	Front plate	Screws	Piercing screw	Installation Manual
Illustration							
Quantity	1	1	1	1	14	3	1 (this document)

**⚠ Caution** Read these safety considerations for installation carefully before installing the product.

● Be sure to observe the following installation precautions to ensure that the product can be used safely:

1. Install the product so that it is situated high enough to allow access to the outdoor unit for maintenance.
2. Installing the product in a location in which it may be exposed to strong winds, secure the outdoor unit with wire or other means.
3. Choose a location where the operating sound will not cause a nuisance to the neighbors of the user.
4. Tighten screws securely. Failure to do so may result in vibration.

**⚠ Caution . . . . .**

Indicates a potentially hazardous situation which, if not avoided, may result in minor or moderate injury. It may also be used to alert against unsafe practises.

#### 1 Installing the snow hood (intake rear plate)

**1 Attach the side plate (right) ①.**

Hook slot  
Screw hole

1. Use the 3 piercing screws ⑥ included in the kit to install the side plate (right) ①.

- For the hook slot, use the first hook slot from the top.
- For the screw hole, use the first screw hole from the bottom.
- Installation is easiest if you start with the hook slot.
- Align the screw installation position with the dowel hole.

**2 Attach the side plate (left) ②**

1. Remove the 2 screws (★) that hold the heat exchanger.  
2. Install the side plate (left) ② using the 2 screws removed in step 1.

**3 Attach the front plate ④**

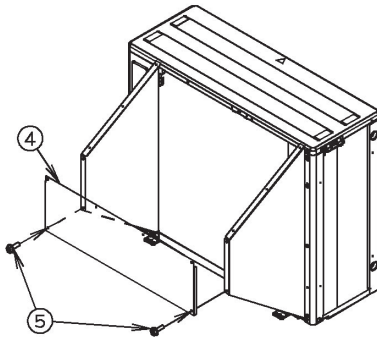

1. Temporarily secure the front plate ④ in place with the 2 screws ⑤ included in the kit.

**4 Attach the top plate ③**

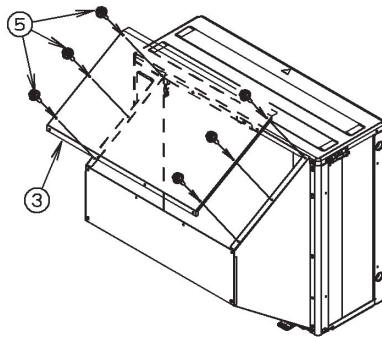

1. Temporarily secure the top plate ③ in place with the 6 screws ⑤ included in the kit.

**5 Attach the top plate ③**

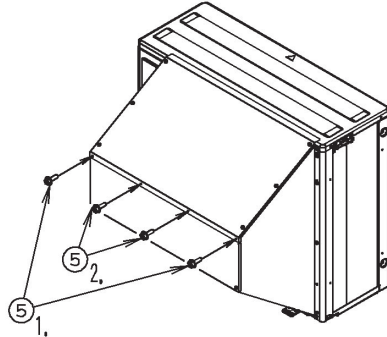

1. Temporarily secure the top plate ③ and front plate ④ to the side plate (right) ① and side plate (left) ② with the 2 screws ⑤ included in the kit.
2. Temporarily secure the top plate ③ to the front plate ④ with the 2 screws ⑤ included in the kit.
3. Tighten the 12 screws that you used to temporarily secure parts in steps 3), 4), and 5).

**2 Appearance of the snow hood (intake rear plate) after installation**

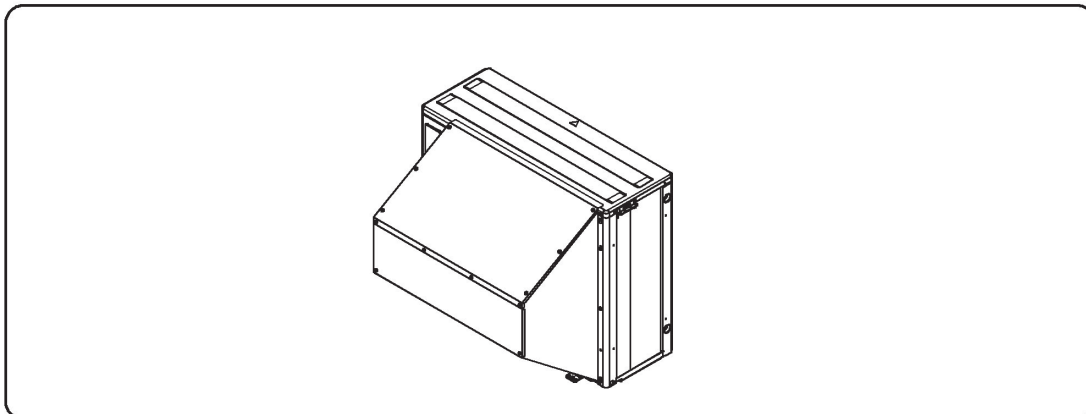

### 14.29 <KPS063A47> Snow Hood (Outlet)

Parts Before assembling the product, verify that all of the following parts have been included:							
Name	Side plate	Side plate	Top plate	Installation plate	Screws	Piercing screw	Installation Manual
Illustration	① (Right)	② (Left)	③	④	⑤	⑥	⑦
Quantity	1	1	1	1	8	3	1 (this document)

**⚠ Caution** Read these safety considerations for installation carefully before installing the product.

● Be sure to observe the following installation precautions to ensure that the product can be used safely:

1. Install the product so that it is situated high enough to allow access to the outdoor unit for maintenance.
2. Installing the product in a location in which it may be exposed to strong winds, secure the outdoor unit with wire or other means.
3. Choose a location where the operating sound will not cause a nuisance to the neighbors of the user.
4. Tighten screws securely. Failure to do so may result in vibration.

**⚠ Caution . . . .**

Indicates a potentially hazardous situation which, if not avoided, may result in minor or moderate injury. It may also be used to alert against unsafe practises.

#### 1 Installing the snow hood (outlet)

1 Remove the discharge grille.

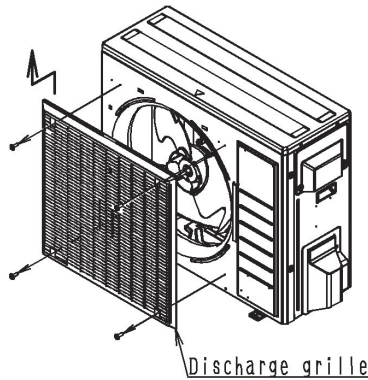

1. Remove the 4 screws that hold the discharge grille, (The discharge grille is held with the 4 screws and 2 hooks.)

2 Attach the side plate (left) ② and installation plate ④.

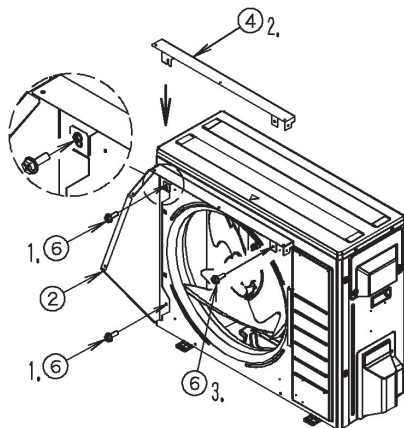

1. Temporarily secure the side plate (left) ② in place with the 2 piercing screw ⑥ included in the kit.

- Installation is easiest if you start with the hook slot.
- Align the screw installation position with the dowel hole.

2. Jointly tighten the installation plate ④ with the 1 piercing screw ⑥ temporarily secured in step 1.
3. Install the right side of the installation plate ④ with the 1 piercing screw ⑥.

**3 Attach the installation plate ④.**

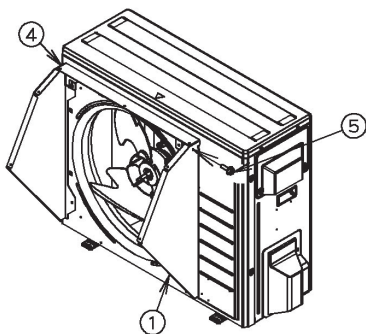

1. Install the side plate (right) ① and installation plate ④ with the 1 screws ⑤ included in the kit.

**4 Attach the discharge grille.**

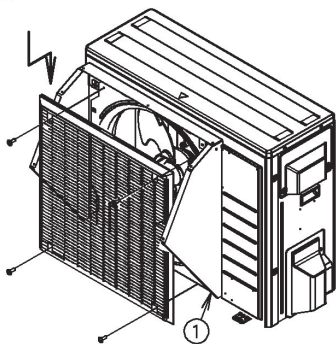

1. When installing the discharge grille removed in [1], jointly tighten the side plate (right) ① with the 2 screws securing the discharge grille. (Secure the discharge grille with the 4 screws and 2 hooks.)

**5 Attach the top plate ③.**

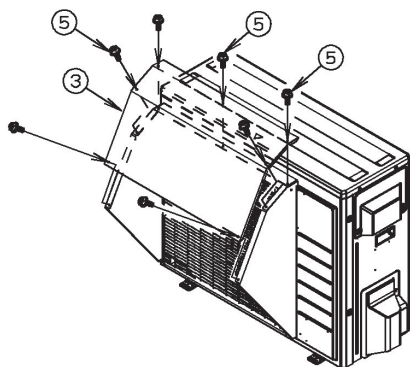

1. Install the top plate ③ with the 7 screws ⑤ included in the kit.

**2 Appearance of the snow hood (outlet) after installation**

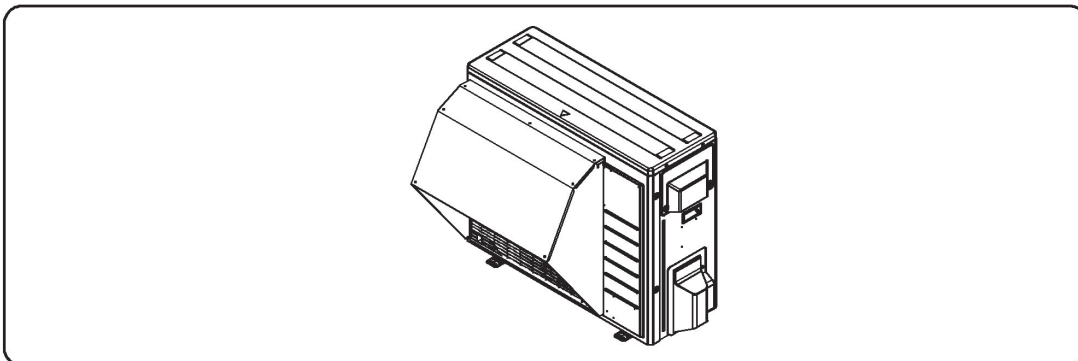





**Warning**



- Ask a qualified installer or contractor to install this product. Do not try to install the product yourself. Improper installation can result in water or refrigerant leakage, electrical shock, fire or explosion.
- Use only those parts and accessories supplied or specified by Daikin. Ask a qualified installer or contractor to install those parts and accessories. Use of unauthorised parts and accessories or improper installation of parts and accessories can result in water or refrigerant leakage, electrical shock, fire or explosion.
- Read the user's manual carefully before using this product. The user's manual provides important safety instructions and warnings. Be sure to follow these instructions and warnings.

If you have any inquiries, please contact your local importer, distributor and/or retailer.

**Cautions on product corrosion**

1. Air conditioners should not be installed in areas where corrosive gases, such as acid gas or alkaline gas, are produced.
2. If the outdoor unit is to be installed close to the sea shore, direct exposure to the sea breeze should be avoided. If you need to install the outdoor unit close to the sea shore, contact your local distributor.