

DAIKIN ROOM AIR CONDITIONER

# INSTALLATION MANUAL

R410A Split Series



Installation manual

Manuel d'installation

Manual de instalación

## MODELS

---

FFQ09W2VJU8

FFQ12W2VJU8

FFQ15W2VJU8

FFQ18W2VJU8

# Contents





<b>Safety Considerations</b> .....	<b>1</b>	<b>Refrigerant Piping Work</b> .....	<b>14</b>
<b>Before Installation</b> .....	<b>3</b>	1. Flaring the pipe end.....	14
<b>Accessories</b> .....	<b>3</b>	2. Refrigerant piping .....	14
<b>Choosing an Installation Site</b> .....	<b>4</b>	<b>Installation of the Decoration Panel</b> .....	<b>15</b>
<b>Indoor Unit Installation</b> .....	<b>6</b>	<b>Field Settings</b> .....	<b>16</b>
1. Relation of ceiling opening to unit and suspension bolt position .....	6	1. Setting air outlet direction.....	16
2. Make the ceiling opening needed for installation where applicable (For existing ceilings).....	7	2. Setting for options.....	16
3. Installing the suspension bolts .....	7	3. Setting remote controller .....	16
4. Installing the indoor unit .....	7	4. Setting air filter sign .....	16
5. Drain piping work.....	8	5. When implementing group control.....	16
6. Wiring .....	11	6. 2 remote controllers (controlling 1 indoor unit by 2 remote controllers).....	17
		<b>Trial Operation and Testing</b> .....	<b>17</b>
		1. Trial operation and testing .....	17
		2. Test items .....	19
		3. How to diagnose for malfunction .....	20
		The pictures in this document are for illustrative purposes only.	

# Safety Considerations

Refer also to the General Safety Considerations in the separate booklet.

	<b>Read the precautions in this manual carefully before operating the unit.</b>
--	---

Read these **Safety Considerations for Installation** carefully before installing an air conditioner or heat pump. After completing the installation, make sure that the unit operates properly during the startup operation. Instruct the user on how to operate and maintain the unit. Inform users that they should store this installation manual with the operation manual for future reference. Always use a licensed installer or contractor to install this product. Improper installation can result in water or refrigerant leakage, electric shock, fire, or explosion. Meanings of **DANGER**, **WARNING**, **CAUTION**, and **NOTE** Symbols:

-  **DANGER** ..... Indicates an imminently hazardous situation which, if not avoided, will result in death or serious injury.
-  **WARNING** ..... Indicates a potentially hazardous situation which, if not avoided, could result in death or serious injury.
-  **CAUTION** ..... Indicates a potentially hazardous situation which, if not avoided, may result in minor or moderate injury. It may also be used to alert against unsafe practices.
-  **NOTE** ..... Indicates situations that may result in equipment or property damage accidents only.

-  **DANGER** .....
- Refrigerant gas is heavier than air and replaces oxygen. A massive leak can lead to oxygen depletion, especially in basements, and an asphyxiation hazard could occur leading to serious injury or death.
  - Do not ground units to water pipes, gas pipes, telephone wires, or lightning rods as incomplete grounding can cause a severe shock hazard resulting in severe injury or death. Additionally, grounding to gas pipes could cause a gas leak and potential explosion causing severe injury or death.

- If refrigerant gas leaks during installation, ventilate the area immediately. Refrigerant gas may produce toxic gas if it comes into contact with fire. Exposure to this gas could cause severe injury or death.
- After completing the installation work, check that the refrigerant gas does not leak throughout the system.
- Do not install unit in an area where flammable materials are present due to risk of explosions that can cause serious injury or death.
- Safely dispose all packing and transportation materials in accordance with federal/state/local laws or ordinances. Packing materials such as nails and other metal or wood parts, including plastic packing materials used for transportation may cause injuries or death by suffocation.

## **WARNING** .....

- Only qualified personnel licensed or certified in their jurisdiction must carry out the installation work. Installation must be done in accordance with this installation manual. Improper installation may result in water leakage, electric shock, or fire.
- When installing the unit in a small room, take measures to keep the refrigerant concentration from exceeding allowable safety limits. Excessive refrigerant leaks, in the event of an accident in a closed ambient space, can lead to oxygen deficiency.
- Use only specified accessories and parts for installation work. Failure to use specified parts may result in water leakage, electric shock, fire, or the unit falling.
- Install the air conditioner or heat pump on a foundation strong enough that it can withstand the weight of the unit. A foundation of insufficient strength may result in the unit falling and causing injuries.
- Take into account strong winds, typhoons, or earthquakes when installing. Improper installation may result in the unit falling and causing accidents.
- Make sure that a separate power supply circuit is provided for this unit and that all electrical work is carried out by qualified personnel licensed or certified in their jurisdiction according to local, state, and national regulations. An insufficient power supply capacity or improper electrical construction may lead to electric shock or fire.
- Make sure that all wiring is secured, that specified wires are used, and that no external forces act on the terminal connections or wires. Improper connections or installation may result in fire.

- When wiring, position the wires so that the electrical wiring box cover can be securely fastened. Improper positioning of the electrical wiring box cover may result in electric shock, fire, or the terminals overheating.
- Before touching electrical parts, turn off the unit.
- The circuit must be protected with safety devices in accordance with local and national codes, i.e. a circuit breaker.
- Securely fasten the outdoor unit terminal cover (panel). If the terminal cover/panel is not installed properly, dust or water may enter the outdoor unit causing fire or electric shock.
- When installing or relocating the system, keep the refrigerant circuit free from substances other than the specified refrigerant (R410A) such as air. Any presence of air or other foreign substance in the refrigerant circuit can cause an abnormal pressure rise or rupture, resulting in equipment damage and even injury.
- Do not change the setting of the protection devices. If the pressure switch, thermal switch, or other protection device is shorted and operated forcibly, or parts other than those specified by Daikin are used, fire or explosion may occur.
- Do not use means to accelerate the defrosting process (if possible) or to clean, other than those recommended by the manufacturer.
- The appliance must be stored in a room without continuously operating ignition sources (for example: open flames, an operating gas appliance or an operating electric heater).
- Do not pierce or burn.
- Be aware that refrigerants may not contain an odor.
- Comply with national gas regulations.

### CAUTION

- Do not touch the switch with wet fingers. Touching a switch with wet fingers can cause electric shock.
- Do not allow children to play on or around the unit to prevent injury.
- Wear adequate personal protective equipment (protective gloves, safety glasses,...) when installing, maintaining or servicing the system.
- The heat exchanger fins are sharp enough to cut. To avoid injury, wear gloves or cover the fins while working around them.
- Do not touch the refrigerant pipes during and immediately after operation as the refrigerant pipes may be hot or cold, depending on the condition of the refrigerant flowing through the refrigerant piping, compressor, and other refrigerant cycle parts. Your hands may suffer burns or frostbite if you touch the refrigerant pipes. To avoid injury, give the pipes time to return to normal temperature or, if you must touch them, be sure to wear proper gloves.
- Install drain piping to ensure proper drainage. Improper drain piping may result in water leakage and property damage.
- Insulate piping to prevent condensation.
- Be careful when transporting the product.
- Do not turn off the power immediately after stopping operation. Always wait for at least 5 minutes before turning off the power. Otherwise, water leakage may occur.
- Do not use a charging cylinder. Using a charging cylinder may cause the refrigerant to deteriorate.
- Refrigerant R410A in the system must be kept clean, dry, and tight.

- (a) Clean and Dry -- Foreign materials (including mineral oils such as SUNISO oil or moisture) should be prevented from getting into the system.

- (b) Tight -- R410A does not contain any chlorine, does not destroy the ozone layer, and does not reduce the earth's protection against harmful ultraviolet radiation. R410A can contribute to the greenhouse effect if it is released. Therefore take proper measures to check for the tightness of the refrigerant piping installation. Read the chapter *Refrigerant Piping Work* and follow the procedures.
- Since R410A is a blend, the required additional refrigerant must be charged in its liquid state. If the refrigerant is charged in a state of gas, its composition can change and the system will not work properly.
- The indoor unit is for R410A. See the catalog for outdoor models that can be connected. Normal operation is not possible when connected to non-compatible outdoor units.
- Remote controller (wireless kit) transmitting distance can be shorter than expected in rooms with electronic fluorescent lamps (inverter or rapid start types). Install the indoor unit far away from fluorescent lamps as much as possible.
- Indoor units are for indoor installation only. Outdoor units can be installed either outdoors or indoors.
- Do not install the air conditioner or heat pump in the following locations:
  - (a) Where a mineral oil mist or oil spray or vapor is produced, for example, in a kitchen. Plastic parts may deteriorate and fall off or result in water leakage.
  - (b) Where corrosive gas, such as sulfurous acid gas, is produced. Corroding copper pipes or soldered parts may result in refrigerant leakage.
  - (c) Near machinery emitting electromagnetic waves. Electromagnetic waves may disturb the operation of the control system and cause the unit to malfunction.
  - (d) Where flammable gas may leak, where there is carbon fiber, or ignitable dust suspension in the air, or where volatile flammables such as thinner or gasoline are handled. Operating the unit in such conditions can cause a fire.
- Take adequate measures to prevent the outdoor unit from being used as a shelter by small animals. Small animals making contact with electrical parts can cause malfunctions, smoke, or fire. Instruct the user to keep the area around the unit clean.
- Servicing shall be performed only as recommended by the manufacturer and licensed or certified in their jurisdiction.

### NOTE

- The indoor unit should be positioned where the unit and inter-unit wires (outdoor to indoor) are at least 3.3ft (1m) away from any televisions or radios. (The unit may cause interference with the picture or sound.) Depending on the radio waves, a distance of 3.3ft (1m) may not be sufficient to eliminate the noise.
- Dismantling the unit, treatment of the refrigerant, oil and additional parts must be done in accordance with the relevant local, state, and national regulations.
- Only use tools for R410A, such as a gauge manifold, charge hose, gas leak detector, reverse flow check valve, refrigerant charge base, vacuum gauge, or refrigerant recovery equipment.
- If the conventional refrigerant and refrigerator oil are mixed in R410A, the refrigerant may deteriorate.
- This air conditioner or heat pump is an appliance that should not be accessible to the general public.
- As maximum allowable pressure is 604psi (4.17MPa), the wall thickness of field-installed pipes should be selected in accordance with the relevant local, state, and national regulations.

FTN005-U









# Before Installation

- Leave the unit inside its packaging until you reach the installation site. Where unpacking is unavoidable, use a sling of soft material or protective plates together with a rope when lifting, this to avoid damage or scratches to the unit. When unpacking the unit or when moving the unit after unpacking, be sure to lift the unit by holding on to the hanger bracket without exerting any pressure on other parts, especially on refrigerant piping, drain piping and other resin parts.
- Refer to the installation manual of the outdoor unit for items not described in this manual.
- Caution concerning refrigerant series R410A:  
The connectable outdoor units must be designed exclusively for R410A.

## Precautions

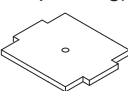
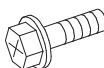
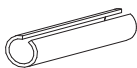
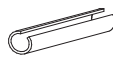
- Do not install or operate the unit in places mentioned below.
  - Places with mineral oil, or filled with oil vapor or spray like in kitchens. (Plastic parts may deteriorate.)
  - Where corrosive gas like sulphurous gas exists. (Copper tubing and brazed spots may corrode.)
  - Where volatile flammable gas like thinner or gasoline is used.
  - Where machines generating electromagnetic waves exist. (Control system may malfunction.)
  - Where the air contains high levels of salt such as near the ocean and where voltage fluctuates a lot (e.g. in factories). Also inside vehicles or vessels.
- When selecting the installation site, use the supplied (E) template for installation.
- Do not install accessories on the casing directly. Drilling holes in the casing may damage electrical wires and consequently cause fire.
- Take off static electricity from the body when carrying out wiring and the electrical wiring box cover is removed. The electric parts may be damaged.

# Accessories

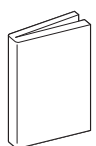
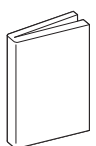
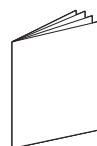
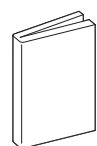
(A) Drain hose 	1	(B) Clamp metal 	1	(C) Washer for hanger bracket 	8	(D) Clamp 	7
(E) Template (cut out from upper part of packing) 	1	(F) Screws (M5) (for template) 	4	(G) Fitting insulation (for gas pipe) 	1	(H) Fitting insulation (for liquid pipe) 	1
(J) Sealing pad (large) 	1	(K) Sealing pad (medium A) 	1	(L) Sealing pad (medium B) 	1	(M) Sealing pad (small) 	1
(N) Operation manual 	1	(P) Installation manual 	1	(Q) Warranty 	1	(R) General safety considerations 	1

## Optional Accessories

- The optional decoration panel and remote controller are required for this indoor unit.

Table 1

Optional decoration panel
BYFQ60C3W2W Color: White

- There are 2 types of remote controllers: wired and wireless. Select a remote controller from Table 2 according to customer request and install in an appropriate place.

Table 2

Remote controller type	Model name
Wired type	BRC1E73
Wireless type	BRC082A42W

- If you wish to use a remote controller that is not listed in Table 2, select a suitable remote controller after consulting catalogs and technical materials.

# Choosing an Installation Site

Hold the unit by the 4 hanger brackets when opening the box and moving it, and do not exert pressure on to any other part, piping (refrigerant, drain, etc.), or plastic parts.

If the temperature or humidity inside the ceiling might rise above 86°F (30°C) or RH 80%, respectively, add extra insulation to the unit.

Use polyethylene foam as insulation and make sure it is at least 3/8 inch (10mm) thick and fits inside the ceiling opening.

**Select the air flow directions best suited to the room and point of installation.**

**For air discharge in 3 directions, it is necessary to make field settings by means of the remote controller and to close the air outlet (s).**

**Refer to the installation manual of the blocking pad kit (sold separately) and to “Field Settings” on page 16.**

- Before choosing the installation site, obtain user approval.

The indoor unit should be positioned in a place where:

- 1) both the air inlet and air outlet are unobstructed,
- 2) the unit is not exposed to direct sunlight,
- 3) the unit is away from the source of heat or steam,
- 4) there is no source of machine oil vapor (this may shorten the indoor unit service life),
- 5) cool/warm air is circulated throughout the room,
- 6) the unit is away from electronic ignition type fluorescent lamps (inverter or rapid start type) as they may affect the remote controller range,
- 7) no laundry equipment is nearby,
- 8) drainage can be performed without any problem,
- 9) the weight of the indoor unit can be adequately supported,
- 10) the wall and the ceiling's lower surface are not significantly tilted,
- 11) room can be left for installation and service work,
- 12) there is no risk of flammable gas leaking,
- 13) the required length of indoor-outdoor piping would not exceed the specified maximum length (see the installation manual that came with the outdoor unit for details).

# Choosing an Installation Site

## Installation Space Requirements

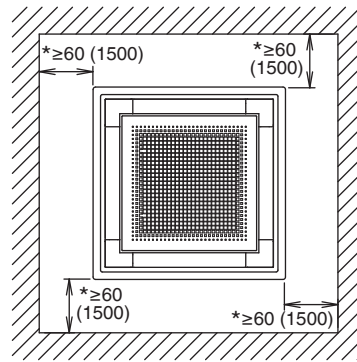
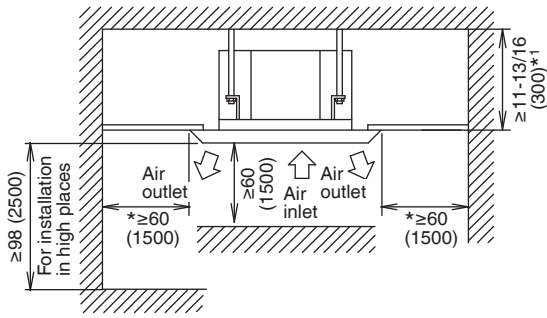

unit:inch (mm)

\*1 These dimensions do not include the dimensions of any added extra insulation, so please secure additional space when adding extra insulation.

- Leave 8 inch (200mm) or more space where marked with the \*, on sides where the air outlet is closed.

### <Failure example>

If there is an obstacle in the airflow path or proper installation space is not provided, the indoor unit will cause air volume reduction and take in air blown out of the indoor unit, thus resulting in performance degradation or turning the thermostat OFF frequently.

## Air flow direction

- The air direction shown is an example.
- Select the appropriate number of directions according to the shape of the room and the location of the unit. (Field settings have to be made using the remote controller and the outlet vents have to be shut off if 2 or 3 directions are selected. See the blocking pad kit (sold separately) installation manual for details.)

### Air flow direction (Example)

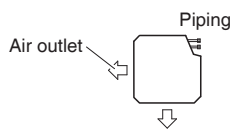

Air outlet in 2 directions

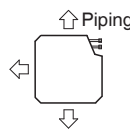

Air outlet in 3 directions

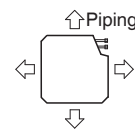

Air outlet in 4 directions

**Use suspension bolts for installation. Check whether the ceiling is strong enough to support the weight of the unit or not. If there is a risk, reinforce the ceiling before installing the unit.**

(Installation pitch is marked on the (E) template. Refer to it to check for points requiring reinforcing.)



# Indoor Unit Installation

## 2. Make the ceiling opening needed for installation where applicable (For existing ceilings)

- Refer to the (E) template for ceiling opening dimensions.
- Create the ceiling opening required for installation. From the side of the opening to the casing outlet, implement the refrigerant and drain piping and wiring for remote controller (unnecessary for wireless type) and wiring between units. Refer to each Drain piping work or Wiring section.
- After making an opening in the ceiling, it may be necessary to reinforce ceiling beams to keep the ceiling level and to prevent it from vibrating. Consult the builder for details.

## 3. Installing the suspension bolts

(Use either a M8-M10 size bolt or the equivalent)  
Use a hole-in anchor for existing ceilings, and a sunken insert, sunken anchor or other field supplied parts for new ceilings to reinforce the ceiling to bear the weight of the unit. Adjust clearance (2-4 inch (50-100mm)) from the ceiling before proceeding further.

- All the above parts are field supplied.

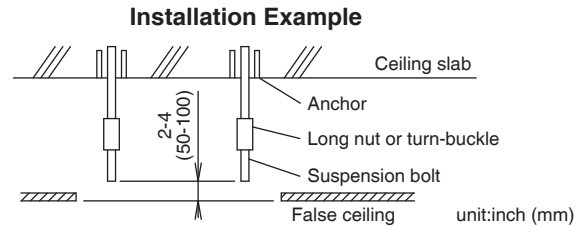

## 4. Installing the indoor unit

**When installing optional accessories (except for the decoration panel), read also the installation manual of the optional accessories. Depending on the field conditions, it may be easier to install optional accessories before the indoor unit is installed. However, for existing ceilings, always install fresh air intake kit before installing the unit.**

As for the parts to be used for installation work, be sure to use the provided accessories and specified parts designated by Daikin.

### For new ceilings

- 1) Install the indoor unit temporarily.
  - Attach the hanger bracket to the suspension bolt. Be sure to fix it securely by using a nut and (C) washer from the upper and lower sides of the hanger bracket.

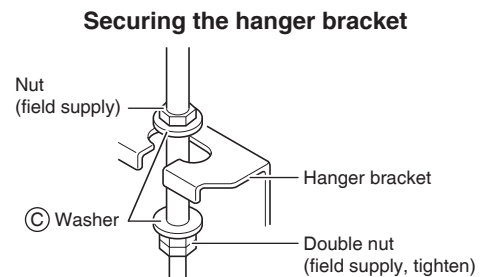

- 2) Refer to the (E) template for ceiling opening dimension. Consult the builder or carpenter for details.
  - The center of the ceiling opening is indicated on the (E) template. This indication also indicates the center of the unit.
  - The (E) template can be rotated by 90° to be able to indicate the correct dimensions on all 4 sides.
  - After cutting the template from the packaging, attach the (E) template to the unit with (F) screws (x4) as shown in figure.
  - Ceiling height is shown on the side of the (E) template. Adjust the height of the unit according to this indication.

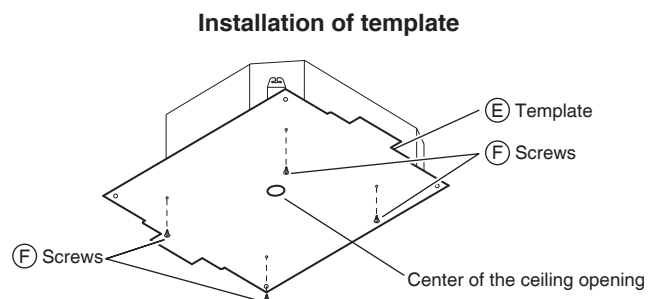

### Ceiling work

- 3) Adjust the unit to the right position for installation. (Refer to 1. Relation of ceiling opening to unit and suspension bolt position.)

## ⚠ CAUTION

If the unit is tilted against condensate flow, the float switch may malfunction and cause water to drip.

- 4) Check the unit is horizontally level.
  - The indoor unit is equipped with a built-in drain pump and float switch. Verify that it is level by using a water level or a water-filled vinyl tube.
- 5) Remove the (E) template.

### Maintaining horizontality

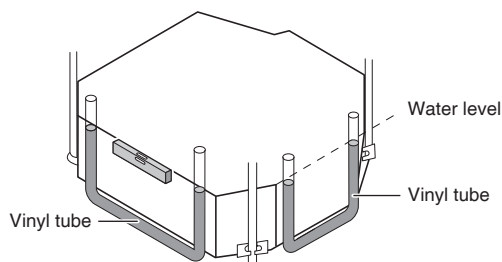

### For existing ceilings

- 1) Install the indoor unit temporarily.
  - Attach the hanger bracket to the suspension bolt. Be sure to fix it securely by using a nut and (C) washer from the upper and lower sides of hanger bracket.

### Securing the hanger bracket

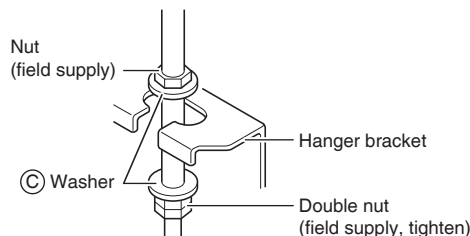

- 2) Adjust the height and position of the unit.  
(Refer to **1. Relation of ceiling opening to unit and suspension bolt position.**)
- 3) Perform steps 4) in **For new ceilings**.

## 5. Drain piping work

### ⚠ CAUTION

- Water pooling in the drainage piping can cause the drain to clog.
- **Do not connect the drain piping directly to sewage pipes that smell of ammonia. The ammonia in the sewage might enter the indoor unit through the drain pipes and corrode the heat exchanger.**
- **Keep in mind that the drain pipe becomes blocked if water collects on it.**

### 1. Install of drain piping

- Install the drain piping as shown in the figure and take measures against condensation. Improperly rigged piping could lead to leaks and eventually wet furniture and belongings.
- Keep piping as short as possible and slope it downwards at a gradient of at least 1/100 so that air may not remain trapped inside the pipe.
- Keep pipe size equal to or greater than that of the connecting pipe (vinyl pipe of nominal diameter 13/16 inch (20mm) and outer diameter 1 inch (26mm)).
- Push the supplied drain hose as far as possible over the drain socket.
- If the drain hose cannot be sufficiently set on a slope, refer to **“Precautions for drain raising piping”**.
- To keep the drain hose from sagging, space hanger bracket every 40-60 inch (1000-1500mm).

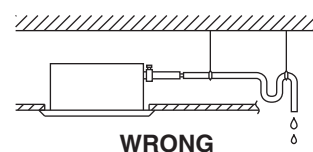
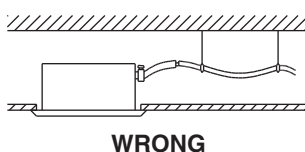
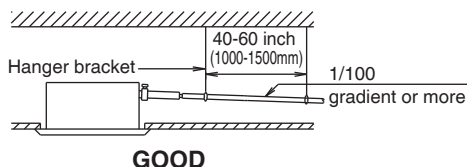

# Indoor Unit Installation

- Tighten the (B) clamp metal as indicated in the illustration.
- After the testing of drain piping is finished, attach the drain (J) sealing pad (large) supplied with the unit over the uncovered part of the drain socket (= between drain hose and unit body).
- Wrap the supplied large sealing pad over the (B) clamp metal and (A) drain hose to insulate and fix it with clamps.
- Insulate the complete drain piping inside the building (field supply).
- If the drain hose cannot be sufficiently set on a slope, fit the hose with drain raising piping (field supply).

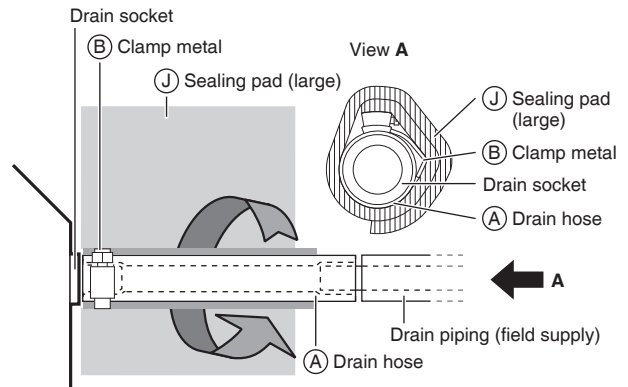

## Precautions for drain raising piping

- Install the drain raising pipes at a height of less than H2.
- Install the drain raising pipes at a right angle to the indoor unit and no more than 11-3/4 inch (300mm) from the unit.

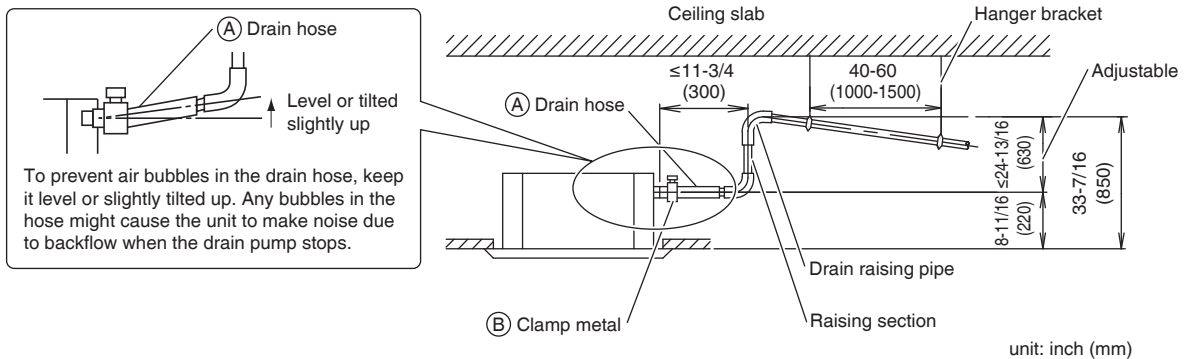

- To ensure no excessive pressure is applied to the included (A) drain hose, do not bend or twist the hose when installing as it could cause leakage.
- If converging multiple drain pipes, install according to the procedure shown below.

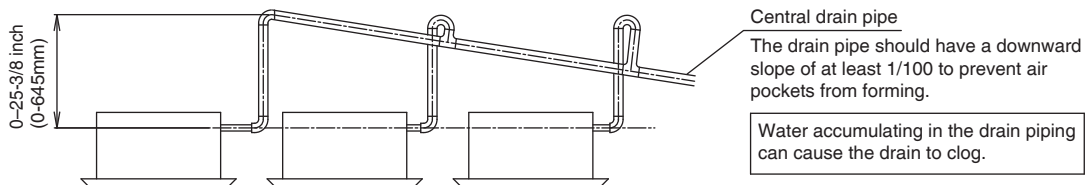

Select converging drain pipes with gauges is suitable for the operating capacity of the unit.

## 2. After piping work is finished, check if drainage flows smoothly

- Add approximately 1/4 gal of water slowly from the air outlet and check drainage flow.

### Method of adding water

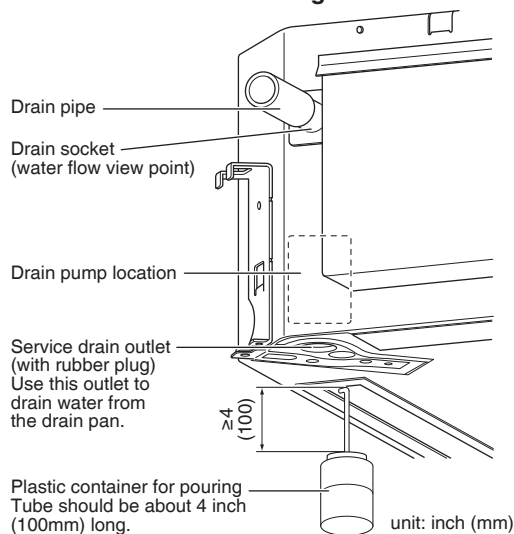

### When electric wiring work is finished

- Check drainage flow during COOL operation, explained in “Trial operation and testing” on page 17.

### When electric wiring work is not finished

## ⚠ CAUTION

Electrical wiring work should be done by a certified electrician.

- If someone who does not have the proper qualifications performs the work, perform the following actions after the trial operation is complete.
  - 1) Remove the electrical wiring box cover (2 screws). Connect the single phase power supply (SINGLE PHASE 60 Hz 208/230V) to connections No.1 and No.2 on the terminal block for power supply.  
Do not connect to No.3 of the terminal block for power supply or the drain pump will not operate.  
When carrying out wiring work around the electrical wiring box, make sure none of the connectors come undone.  
Be sure to attach the electrical wiring box cover before turning on the power.
  - 2) After confirming drainage, turn off the power supply and remove the power supply wiring.
  - 3) Attach the electrical wiring box cover as before.

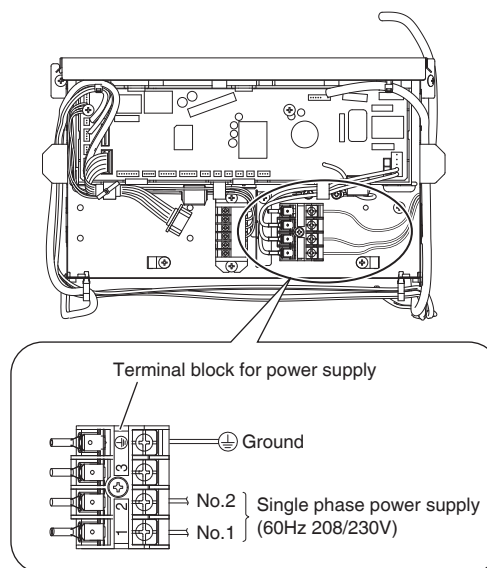
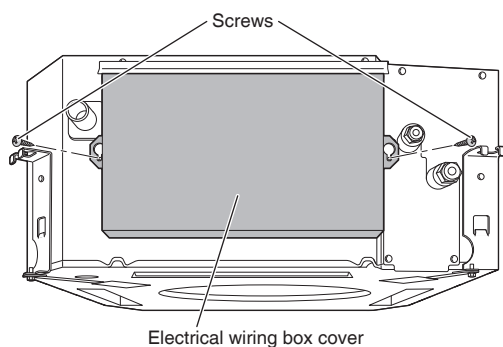

# Indoor Unit Installation

## 6. Wiring

Refer also to the installation manual for the outdoor unit.

### ⚠ WARNING

- Do not use tapped wires, extension cords, or starburst connections, as they may cause overheating, electric shock, or fire.
- Do not use locally purchased electrical parts inside the product. (Do not branch the power for the drain pump, etc., from the terminal block.) Doing so may cause electric shock or fire.
- Do not connect the power wire to the indoor unit. Doing so may cause electric shock or fire.

### ⚠ CAUTION

Recommend stranded cable for interunit wiring. Local code always supersedes recommendation.

- For stranded wires, make sure to use the round crimp-style terminal for connection to the power supply terminal block. Place the round crimp-style terminals on the wires up to the covered part and secure in place.

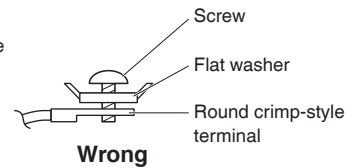
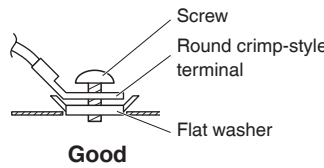
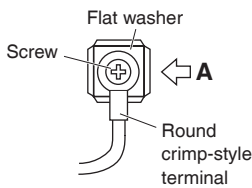
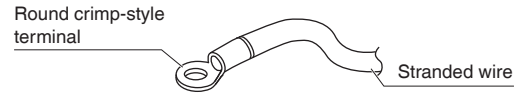

Arrow view A

- If solid core wire must be used, be sure to curl the end of the lead. Improper work may cause heat and fire.

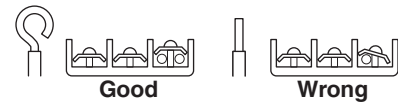

- When clamping wiring, use the included clamping material to prevent outside pressure being exerted on the wiring connections and clamp firmly. When doing the wiring, make sure the wiring is neat and does not cause the electrical wiring box cover to stick up, then close the cover firmly.
- Outside the unit, separate the low voltage wiring (remote controller wiring) and high voltage wiring (wiring between units, ground, and other power wiring) at least 2 in. so that they do not pass through the same place together. Proximity may cause electrical interference, malfunctions, and breakage.

### Tightening torque for the terminal blocks

- Use the correct screwdriver for tightening the terminal screws. If the blade of screwdriver is too small, the head of the screw might be damaged, and the screw will not be properly tightened.
- If the terminal screws are tightened too hard, screws might be damaged.
- Refer to the table below for the tightening torque of the terminal screws.

unit: lbf • ft (N • m)

	Tightening torque
Terminal block for remote controller (6P)	0.58 - 0.72 (0.79 - 0.98)
Terminal block for power supply (4P)	0.87 - 1.06 (1.18 - 1.44)

- For electric wiring work, refer also to “**Wiring diagram label**” attached to the electrical wiring box cover.
- For remote controller wiring details, refer to the installation manual attached to the remote controller.
- A circuit breaker capable of shutting down power supply to the entire system must be installed.
- **Specifications for field wire**

The remote controller wiring should be procured locally.

Table 3

	Wire	Size	Length
Wiring between units	Recommend stranded and shielded. Local code supersedes recommendation.	AWG 14	–
Remote controller wiring	Sheathed (2 wire)	AWG 18 - 16	Max. 1640ft (500m)*
Wiring to ground terminal	Recommend stranded and shielded. Local code supersedes recommendation.	–	–

\* This will be the total extended length in the system when doing group control.

### CAUTION

- Arrange the wires and fix a cover firmly so that the cover does not float during wiring work.
- Do not clamp remote controller wiring together with wiring between units. Doing so may cause malfunction.
- Remote controller wiring and wiring between units should be located at least 2 inch (50mm) from other electric wires. Not following this guideline may result in malfunction due to electrical noise.

# Indoor Unit Installation

## Connection of wiring between units, ground wire and remote controller wiring

### Wiring between units and ground wire

- 1) Remove the electrical wiring box cover (2 screws).

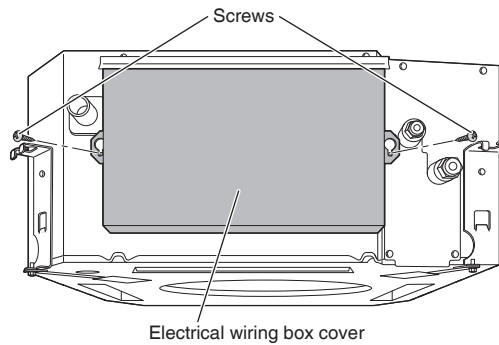

- 2) Insert the wires including the ground wire into the conduit, and secure the conduit to the hole in the electrical wiring box using a lock nut, as shown in the illustration.

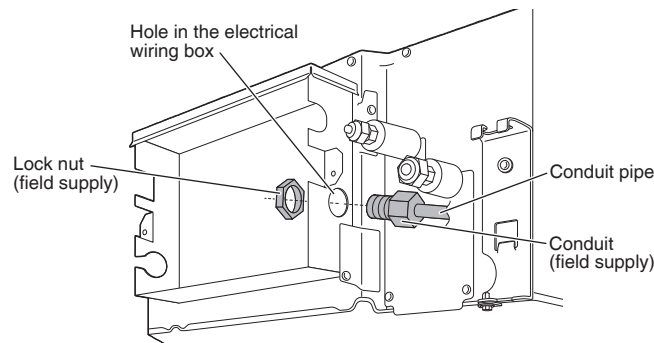

- 3) Connect the ground wire to the corresponding terminals.
- 4) Match wire colors with terminal numbers on the terminal block for power supply of indoor and outdoor unit and firmly secure the wires in the corresponding terminals with screws.
- 5) In doing this, pull the wires inside through the hole and fix the wires securely with the included (D) clamp.
- 6) Give enough slack to the wires between the (D) clamp and terminal block for power supply.
- 7) Pull the wires inside through the hole and connect them to the terminal block for remote controller (P1, P2) (no polarity). Securely fix the remote controller wiring with the included (D) clamp.
- 8) Give enough slack to the wires between the (D) clamp and the terminal block for remote controller.
- 9) Insert the decoration panel connector into the relay connector.
- 10) Attach the electrical wiring box cover as before.
- 11) After all wiring connections are done, fill in any gaps in the casing wiring holes with putty or (M) sealing pad (small) thus to prevent small animals or dirt from entering the unit from outside and causing short circuits in the electrical wiring box.

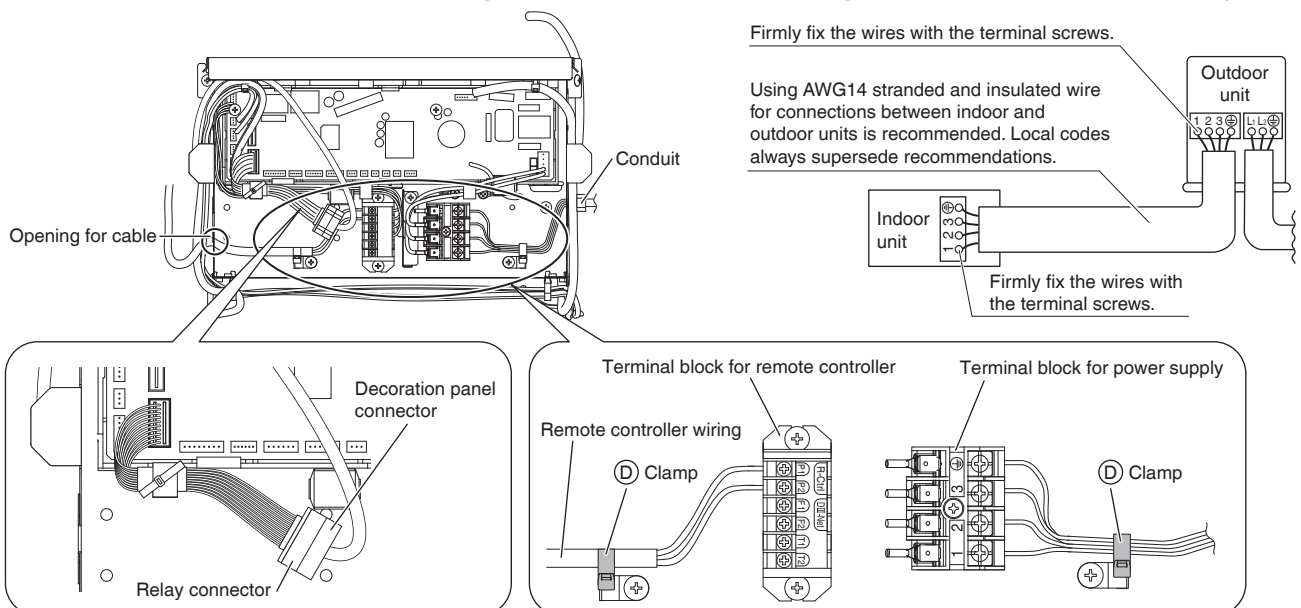

# Refrigerant Piping Work

Refer also to the installation manual for the outdoor unit.

## ⚠ WARNING

- Do not apply mineral oil on flared part.
- Prevent mineral oil from getting into the system as this would reduce the service life of the units.
- Never use piping which has been used for previous installations. Only use parts which are delivered with the unit.
- Never install a dryer to this R410A unit in order to guarantee its service life.
- The drying material may dissolve and damage the system.
- Incomplete flaring may result in refrigerant gas leakage.

Execute thermal insulation work completely on both sides of the gas and the liquid piping. Otherwise, a water leakage can result sometimes.

Be sure to use insulation designed for use with HVAC systems.

Also, in cases where the temperature and humidity of the refrigerant piping sections might exceed 86°F (30°C) or RH80%, reinforce the refrigerant insulation. (13/16 inch (20mm) or thicker) Condensation may form on the surface of the insulating material.

Before refrigerant piping work, check which type of refrigerant is used. Proper operation is not possible if the types of refrigerant are not the same.

## 1. Flaring the pipe end

- 1) Cut the pipe end with a pipe cutter.
- 2) Remove burrs with the cut surface facing downward so that the filings do not enter the pipe.

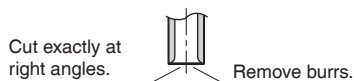

- 3) Put the flare nut on the pipe.
- 4) Flare the pipe.
- 5) Check that the flaring has been done correctly.

Flaring			
Set exactly at the position shown below.			
Flare tool for R410A	Conventional flare tool		
	Clutch-type	Clutch-type (Rigid-type)	Wing-nut type (Imperial-type)
A	0-0.020 inch (0-0.5mm)	0.039-0.059 inch (1.0-1.5mm)	0.059-0.079 inch (1.5-2.0mm)

Check	
The flare's inner surface must be flaw-free.	The pipe end must be evenly flared in a perfect circle.
When flaring, do not over-tighten and crack.	Make sure that the flare nut is fitted.

## 2. Refrigerant piping

### ⚠ CAUTION

- Use the flare nut fixed to the main unit. (This is to prevent the flare nut from cracking as a result of deterioration over time.)
- To prevent gas leakage, apply refrigeration oil only to the inner surface of the flare. (Use refrigeration oil for R410A.)
- Use a torque wrench when tightening the flare nuts to prevent damage to the flare nuts and gas leakage.

- Align the centers of both flares and tighten the flare nuts 3 or 4 turns by hand, then tighten them fully with a spanner and a torque wrench.

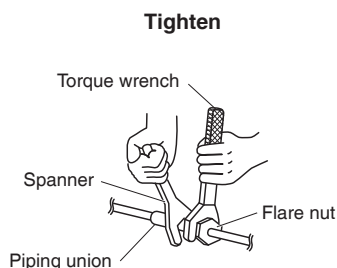
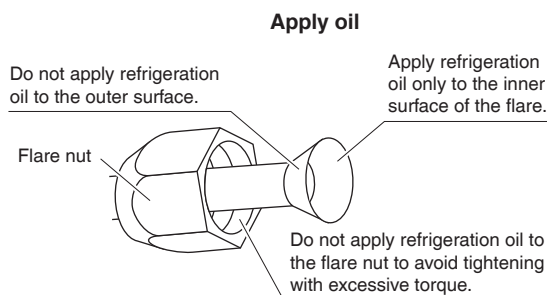

	Piping size	Flare nut tightening torque
Gas side	O.D. 3/8 inch (9.5mm)	24-1/8–29-1/2lbf • ft (32.7-39.9N • m)
	O.D. 1/2 inch (12.7mm)	36-1/2–44-1/2lbf • ft (49.5-60.3N • m)
Liquid side	O.D. 1/4 inch (6.4mm)	10-1/2–12-3/4lbf • ft (14.2-17.2N • m)

### Cautions on piping handling

- Protect the open end of the pipe from dust and moisture.
- All pipe bends should be as gentle as possible. Use a pipe bender for bending.

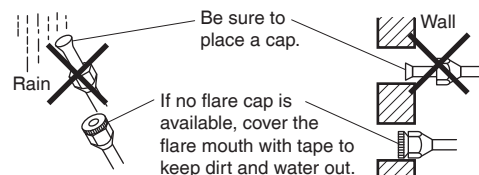

# Refrigerant Piping Work

## Selection of copper and heat insulation materials

When using commercial copper pipes and fittings, observe the following:

- Insulation material: Polyethylene foam  
Heat transfer rate: 0.041 to 0.052W/mK (0.024 to 0.030Btu/fth°F (0.035 to 0.045kcal/mh°C))  
Be sure to use insulation that is designed for use with HVAC Systems.
- ACR Copper pipe only.

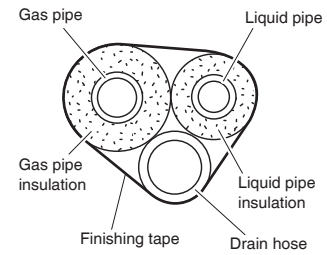

- Be sure to insulate both the gas and liquid piping and observe the insulation dimensions as below.

	Piping size	Minimum bend radius	Piping thickness	Thermal insulation size	Thermal insulation thickness
Gas side	O.D. 3/8 inch (9.5mm)	1-3/16 inch (30mm) or more	0.031 inch (0.8mm) (C1220T-O)	I.D. 15/32-19/32 inch (12-15mm)	13/32 inch (10mm) Min.
	O.D. 1/2 inch (12.7mm)	1-9/16 inch (40mm) or more		I.D. 9/16-5/8 inch (14-16mm)	
Liquid side	O.D. 1/4 inch (6.4mm)	1-3/16 inch (30mm) or more		I.D. 5/16-13/32 inch (8-10mm)	

- Use separate thermal insulation pipes for gas and liquid refrigerant pipes.
- Make absolutely sure to execute thermal insulation works on the pipe-connecting section, after checking for gas leakage, by thoroughly studying the following figures and using the included thermal insulating materials (G) fitting insulation and (H) fitting insulation. Fasten both ends with the (D) clamps.

### Piping insulation procedure

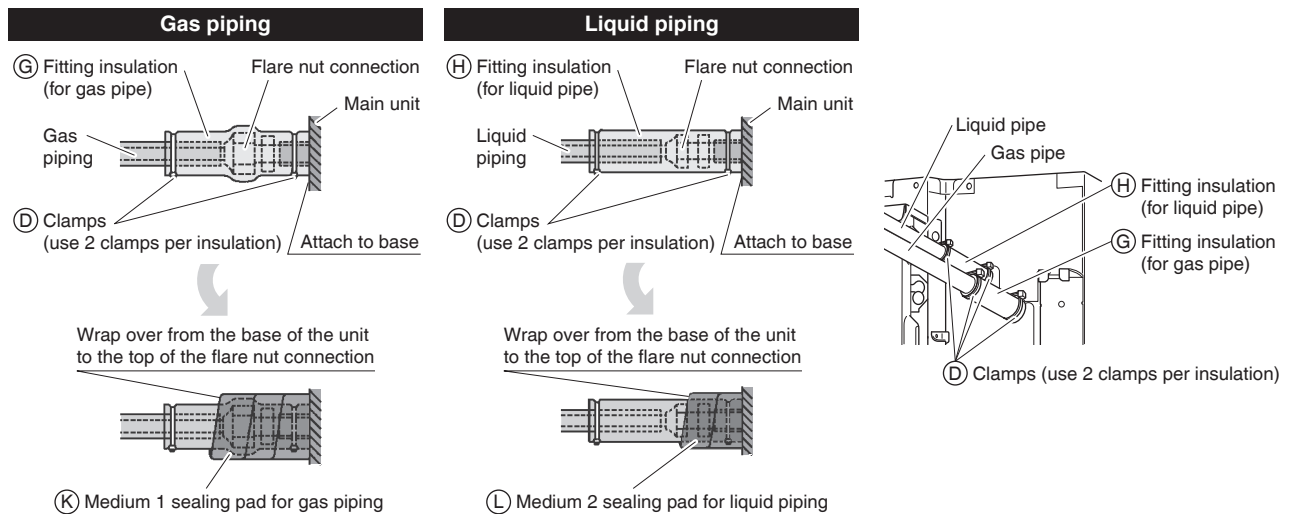

## CAUTION

Be sure to insulate any field piping all the way to the piping connection inside the unit. Any exposed piping may cause condensation or burns if touched.

# Installation of the Decoration Panel

With the wireless remote controller, field setting and trial operation cannot be performed without attaching the decoration panel.

Read “Trial Operation and Testing” before making a trial operation without attaching the decoration panel.

Refer to the installation manual attached to the decoration panel.

After installing the decoration panel, ensure that there is no space between the unit body and decoration panel.

# Field Settings

## ⚠ CAUTION

When performing field setting or trial operation without attaching the decoration panel, do not touch the drain pump. This may cause electric shock.

- Make sure the electrical wiring box cover is closed on the indoor and outdoor units.
- Field settings must be made from the remote controller and in accordance with installation conditions.
- Setting can be made by changing the “Mode No.,” “FIRST CODE NO.” and “SECOND CODE NO.”.
- The “Field Settings” included with the remote control lists the order of the settings and method of operation.

Field Settings			
Unit No	Mode		
0	20		
0-01	1-01	2-02	3-01
4---	5---	6---	7---
8---	9---	10---	11---
12---	13---	14---	15---
Setting ↔			

## 1. Setting air outlet direction

- For changing air outlet direction (2 or 3 directions), refer to the installation manual attached to the blocking pad kit (sold separately) or the service manual.  
(SECOND CODE NO. is factory set to “01” for air outlet in 4 directions.)

## 2. Setting for options

- For settings for options, see the installation manual provided with the option.

## 3. Setting remote controller

### When using wireless remote controllers

- When using the wireless remote controllers, wireless remote controller address setting is necessary. Refer to the installation manual attached to the wireless remote controller.

## 4. Setting air filter sign

- Remote controllers are equipped with liquid crystal display air filter signs to display the time to clean air filters.
- Change the SECOND CODE NO. depending on the amount of dirt or dust in the room.

### AIR FILTER CLEANING TIME INDICATOR lamp display interval

Setting content	Contamination	Mode No.	FIRST CODE NO.	SECOND CODE NO.
Approx. 2500 hrs	Contamination-light	10 (20)	0	01
Approx. 1250 hrs	Contamination-heavy			02

### AIR FILTER CLEANING TIME INDICATOR lamp display

Setting content	Mode No.	FIRST CODE NO.	SECOND CODE NO.
Display ON	10 (20)	3	01
Display OFF*			02

\* Use “Display OFF” setting when cleaning indication is not necessary such as the case of periodical cleaning being carried out.

## 5. When implementing group control

- When using as a pair unit, you may control up to 16 units with the remote controller.
- In this case, all the indoor units in the group will operate in accordance with the group control remote controller.
- Select a remote controller which matches as many of the functions (swing flap, etc.) in the group as possible.

### Wiring Method

- 1) Remove the electrical wiring box cover.  
(Refer to Wiring between units and ground wire in “6. Wiring” on page 13.)
- 2) Cross-wire the terminal block for remote controller (P1, P2) inside the electrical wiring box. (There is no polarity.)  
(Refer to Table 3 in “6. Wiring” on page 12)

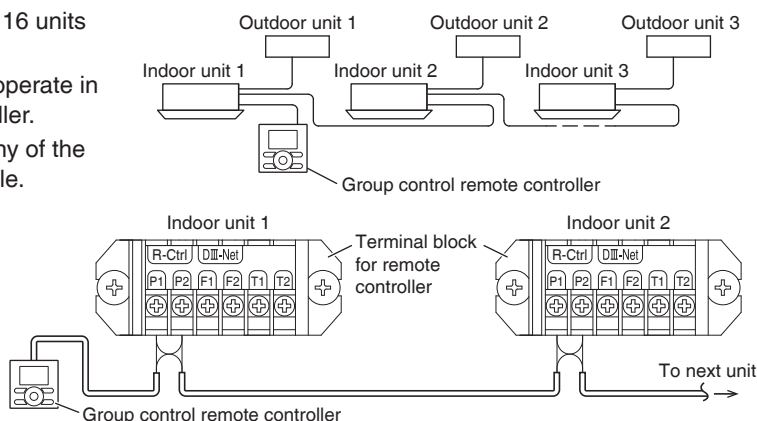

# Field Settings

## 6. 2 remote controllers (controlling 1 indoor unit by 2 remote controllers)

- When using 2 remote controllers, one must be set to “MAIN” and the other to “SUB”.

### Wiring Method

- Remove the electrical wiring box cover.  
(Refer to Wiring between units and ground wire in “6. Wiring” on page 13.)
- Add remote controller 2 to the terminal block for remote controller (P1, P2) in the electrical wiring box. (There is no polarity.)  
(Refer to Table 3 in “6. Wiring” on page 12)

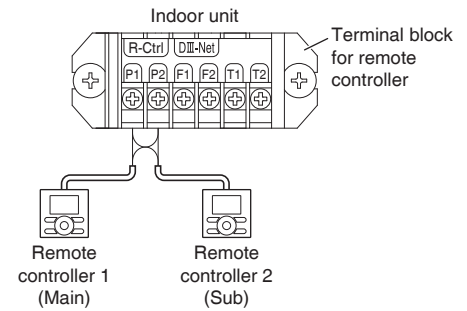

# Trial Operation and Testing

## ⚠ CAUTION

When performing field settings or trial operation without attaching the decoration panel, do not touch the drain pump. This may cause electric shock.

- After finishing the construction of refrigerant piping, drain piping, and electric wiring, conduct trial operation accordingly to protect the unit.

## 1. Trial operation and testing

**Make sure to install the decoration panel before carrying out trial operation if the wireless remote controller is used.**

- Trial operation should be carried out in either COOL or HEAT operation.

**1-1. Measure the supply voltage and make sure that it is within the specified range.**

**1-2. In COOL operation, select the lowest programmable temperature;  
in HEAT operation, select the highest programmable temperature.**

**1-3. Carry out the trial operation following the instructions in the operation manual to ensure that all functions and parts, such as the movement of the louvers, are working properly.**

- To protect the air conditioner, restart operation is disabled for 3 minutes after the system has been turned off.



**1-4. After trial operation is complete, set the temperature to a normal level (78°F to 82°F (26°C to 28°C) in COOL operation, 68°F to 75°F (20°C to 24°C) in HEAT operation).**

- When operating the air conditioner in COOL operation in winter, or HEAT operation in summer, set it to the trial operation mode using the following method.

Refer to **For wired remote controller** on page 18.

Refer to **For wireless remote controller**.

### For wireless remote controller

- Press  and select the COOL or HEAT operation.
- Press  twice. “Test” is displayed.
- Press  within 10 seconds, and the test operation starts.

Monitor the operation of the indoor unit for a minimum of 10 minutes. During test operation, the indoor unit will continue to cool/heat regardless of the temperature setpoint and room temperature.

- In the case of above-mentioned procedures 1) and 2) in reverse order, test operation can start as well.
- Test operation will stop automatically after 15 - 30 minutes. To stop the operation, press .
- Some of the functions cannot be used in the test operation mode.

### For wired remote controller

- 1) Set to COOL or HEAT operation using the remote controller.
- 2) Press and hold Cancel button for 4 seconds or longer. Service settings menu is displayed.
- 3) Select **Test Operation** in the service settings menu, and press Menu/OK button. Basic screen returns and "Test Operation" is displayed at the bottom.
- 4) Press On/Off button within 10 seconds, and the test operation starts.  
Monitor the operation of the indoor unit for a minimum of 10 minutes. During test operation, the indoor unit will continue to cool/heat regardless of the temperature setpoint and room temperature.
  - In the case of above-mentioned procedures 3) and 4) in reverse order, test operation can start as well.
- 5) Press Menu/OK button in the basic screen. Main menu is displayed.
- 6) Select **Air Flow Direction** in the main menu and check that air flow direction is actuated according to the setting. For operation of air flow direction setting, see the operation manual.
- 7) After the operation of air flow direction is confirmed, press Menu/OK button. Basic screen returns.
- 8) Press and hold Cancel button for 4 seconds or longer in the basic screen.  
Service settings menu is displayed.
- 9) Select **Test Operation** in the service settings menu, and press Menu/OK button. Basic screen returns and normal operation is conducted.
  - Test operation will stop automatically after 15-30 minutes. To stop the operation, press On/Off button.
- 10) If the decoration panel has not been installed, turn off the power after the test operation.

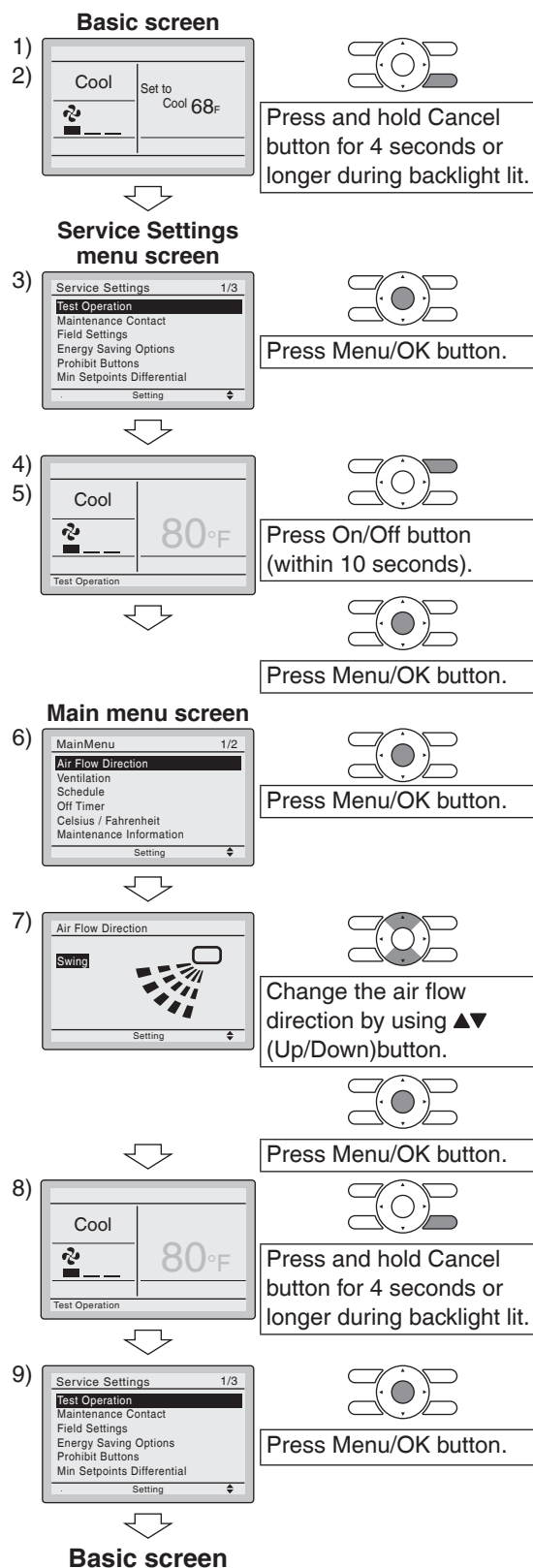

### Precautions

Refer to "3. How to diagnose for malfunction" if the unit does not operate properly.

# Trial Operation and Testing

## 2. Test items



Test items	Symptom	Check
Indoor and outdoor units are installed securely.	Fall, vibration, noise	
Is the outdoor unit fully installed?	No operation or burn damage	
No refrigerant gas leaks.	Incomplete cooling/heating function	
Refrigerant gas and liquid pipes and indoor drain hose extension are thermally insulated.	Water leakage	
Draining line is properly installed.	Water leakage	
Does the power supply voltage correspond to that shown on the name plate?	No operation or burn damage	
Only specified wires are used for all wiring, and all wires are connected correctly.	No operation or burn damage	
System is properly grounded.	Electrical leakage	
Is wiring size according to specifications?	No operation or burn damage	
Is something blocking the air outlet or inlet of either the indoor or outdoor units?	Incomplete cooling/heating function	
Are refrigerant piping length and additional refrigerant charge noted down?	The refrigerant charge in the system is not clear	
Pipes and wires are connected to the corresponding connection ports / terminal blocks for the connected unit.	No cooling/heating	
Stop valves are opened.	Incomplete cooling/heating function	
Check that the connector of the lead wires of the decoration panel is connected securely.	Louvers do not move	
Indoor unit properly receives wireless remote control commands.	No operation	

### Items to be checked at time of delivery

Also review the “Precautions” on page 3

Test items	Check
Are the electrical wiring box cover, air filter, suction grille attached?	
Did you explain about operations while showing the operation manual to your customer?	
Did you hand the operation manual over to your customer?	

### Points for explanation about operations

The items with  WARNING and  CAUTION marks in the operation manual are the items pertaining to possibilities for bodily injury and material damage in addition to the general usage of the product. Accordingly, it is necessary that you make a full explanation about the described contents and also ask your customers to read the operation manual.

### Note to the installer

Be sure to instruct customers how to properly operate the unit (especially cleaning the filter, operating different functions, and adjusting the temperature) by having them carry out operations while looking at the manual.

### 3. How to diagnose for malfunction

- If the air conditioner does not operate normally after installing the air conditioner, a malfunction shown in the table below may happen.

Wired remote controller display	Description
No display	<ul style="list-style-type: none"> <li>• Power outage, power voltage error or open-phase</li> <li>• Incorrect wiring (between indoor and outdoor units)</li> <li>• Indoor PC-board assembly failure</li> <li>• Remote controller wiring not connected</li> <li>• Remote controller failure</li> <li>• Open fuse or tripped circuit breaker (outdoor unit)</li> </ul>
“Checking the connection. Please stand by.” *	<ul style="list-style-type: none"> <li>• Indoor PC-board assembly failure</li> <li>• Wrong wiring (between indoor and outdoor units)</li> </ul>

\* “Checking the connection. Please stand by” will be displayed for up to 90 seconds following the application of power to the indoor unit. This is normal and does not indicate a malfunction.

- Diagnose with the display on the liquid crystal display remote controller.

#### With the wired remote controller

When the operation stops due to a malfunction, operation lamp blinks, and the malfunction code is indicated on the liquid crystal display. In such a case, diagnose the fault contents by referring to **Error History** in the service settings menu. In the case of group control, the unit No. is displayed so that the indoor unit with the trouble can be identified.

#### With the wireless remote controller

(Refer also to the operation manual attached to the wireless remote controller)

When the operation stops due to a malfunction the display on the indoor unit blinks. In such a case, diagnose the fault contents with the error code which can be found by following procedures.

- 1) Press the INSPECTION/TEST OPERATION button, “” is displayed and “0” blinks.
- 2) Press the TEMPERATURE SETTING button and find the unit No. which stopped due to trouble.
 

Number of beeps	3 short beeps.....	Perform all the following operations
	1 short beep .....	Perform (3) and (6)
	1 long beep.....	No trouble
- 3) Press the OPERATION MODE SELECTOR button and upper figure of the error code blinks.
- 4) Continue pressing the TEMPERATURE SETTING button until it makes 2 short beeps and find the upper code.
- 5) Press the OPERATION MODE SELECTOR button and lower figure of the error code blinks.
- 6) Continue pressing the TEMPERATURE SETTING button until it makes a long beep and find the lower code.
  - A long beep indicate the error code.

**DAIKIN COMFORT TECHNOLOGIES NORTH AMERICA, INC.**

19001 Kermier Road  
Waller, TX 77484  
<https://www.northamerica-daikin.com>



**Intertek**



Two-dimensional bar code  
is a manufacturing code.

3P708101-1A

M22B327A (2301) HT