

**DAIKIN**

---

# INSTALLATION MANUAL

---

## R410A Split Series

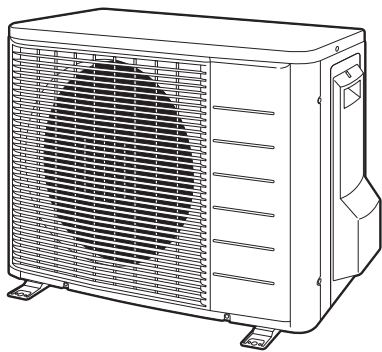

### Models

**RXS09LVJU**

**RXS12LVJU**

Installation manual  
R410A Split series

**English**

Manuel d'installation  
Série split R410A

**Français**

Manual de instalación  
Serie Split R410A

**Español**

# Safety Precautions

- Read these Safety Precautions carefully to ensure correct installation.
- This manual classifies the precautions into DANGER, WARNING and CAUTION.  
Be sure to follow all the precautions below: they are all important for ensuring safety.

 **DANGER** .....Indicates an imminently hazardous situation which, if not avoided, will result in death or serious injury.

 **WARNING** ....Failure to follow any of WARNING is likely to result in such grave consequences as death or serious injury.

 **CAUTION** .....Failure to follow any of CAUTION may in some cases result in grave consequences.

- The following safety symbols are used throughout this manual:

 Be sure to observe this instruction.	 Be sure to establish a ground connection.	 Never attempt.
--	---	--

- After completing installation, test the unit to check for installation errors. Give the user adequate instructions concerning the use and cleaning of the unit according to the Operation Manual.

 <b>DANGER</b>
<ul style="list-style-type: none"> <li>• Refrigerant gas is heavier than air and replaces oxygen. A massive leak could lead to oxygen depletion, especially in basements, and an asphyxiation hazard could occur leading to serious injury or death.</li> </ul>
<ul style="list-style-type: none"> <li>• If the refrigerant gas leaks during installation, ventilate the area immediately. Refrigerant gas may produce a toxic gas if it comes in contact with fire such as from a fan heater, stove or cooking device. Exposure to this gas could cause severe injury or death.</li> </ul>
<ul style="list-style-type: none"> <li>• After completing the installation work, check that the refrigerant gas does not leak. Refrigerant gas may produce a toxic gas if it comes in contact with fire such as from a fan heater, stove or cooking device. Exposure to this gas could cause severe injury or death.</li> </ul>
<ul style="list-style-type: none"> <li>• Do not ground units to water pipes, telephone wires or lightning rods because incomplete grounding could cause a severe shock hazard resulting in severe injury or death, and to gas pipes because a gas leak could result in an explosion which could lead to severe injury or death.</li> </ul>
<ul style="list-style-type: none"> <li>• Safely dispose of the packing materials. Packing materials, such as nails and other metal or wooden parts, may cause stabs or other injuries. Tear apart and throw away plastic packaging bags so that children will not play with them. Children playing with plastic bags face the danger of death by suffocation.</li> </ul>
<ul style="list-style-type: none"> <li>• Do not install unit in an area where flammable materials are present due to risk of explosion resulting in serious injury or death.</li> </ul>
<ul style="list-style-type: none"> <li>• Do not ground units to telephone wires or lightning rods because lightning strikes could cause a severe shock hazard resulting in severe injury or death, and to gas pipes because a gas leak could result in an explosion which could lead to severe injury or death.</li> </ul>

 <b>WARNING</b>
<ul style="list-style-type: none"> <li>• Installation shall be left to the authorized dealer or another trained professional. Improper installation may cause water leakage, electrical shock, fire, or equipment damage.</li> </ul>
<ul style="list-style-type: none"> <li>• Install the air conditioner according to the instructions given in this manual. Incomplete installation may cause water leakage, electrical shock, fire or equipment damage.</li> </ul>
<ul style="list-style-type: none"> <li>• Be sure to use the supplied or exact specified installation parts. Use of other parts may cause the unit to come to fall, water leakage, electrical shock, fire or equipment damage.</li> </ul>
<ul style="list-style-type: none"> <li>• Install the air conditioner on a solid base that is level and can support the weight of the unit. An inadequate base or incomplete installation may cause injury or equipment damage in the event the unit falls off the base or comes loose.</li> </ul>
<ul style="list-style-type: none"> <li>• Electrical work shall be carried out in accordance with the installation manual and the national, state and local electrical wiring codes. Insufficient capacity or incomplete electrical work may cause electrical shock, fire or equipment damage.</li> </ul>
<ul style="list-style-type: none"> <li>• Be sure to use a dedicated power circuit. Never use a power supply shared by another appliance. Follow all appropriate electrical codes.</li> </ul>
<ul style="list-style-type: none"> <li>• For wiring, use a wire or cable long enough to cover the entire distance with no splices if possible. Do not use an extension cord. Do not put other loads on the power supply. Use an only a separate dedicated power circuit. (Failure to do so may cause abnormal heat, electric shock, fire or equipment damage.)</li> </ul>
<ul style="list-style-type: none"> <li>• Use the specified types of wires for electrical connections between the indoor and outdoor units. Follow all state and local electrical codes. Firmly clamp the inter-unit wire so their terminals receive no external stresses. Incomplete connections or clamping may cause terminal overheating, fire or equipment damage.</li> </ul>

# Safety Precautions

## ⚠ WARNING

- After connecting all wires be sure to shape the cables so that they do not put undue stress on the electrical covers, panels or terminals.  
Install covers over the wires. Incomplete cover installation may cause terminal overheating, electrical shock, fire or equipment damage.
- When installing or relocating the system, be sure to keep the refrigerant circuit free from all substances other than the specified refrigerant (R410A), such as air.  
(Any presence of air or other foreign substance in the refrigerant circuit causes an abnormal pressure rise which may result in rupture, resulting in injury.)
- During pump-down, stop the compressor before removing the refrigerant piping.  
If the compressor is still running and the stop valve is open during pump-down, air will be sucked in when the refrigerant piping is removed, causing abnormally high pressure which could lead to equipment damage or and personal injury.
- During installation, attach the refrigerant piping securely before running the compressor.  
If the refrigerant pipes are not attached and the stop valve is open during installation, air will be sucked in when the compressor is run, causing abnormally high pressure which could lead to equipment damage and personal injury.
- Be sure to install a ground fault circuit interrupter breaker.  
Failure to install a ground fault circuit interrupter breaker may result in electrically shocks, or fire personal injury.

## ⚠ CAUTION

- Do not install the air conditioner where gas leakage would be exposed to open flames. ⊘  
If the gas leaks and builds up around the unit, it may catch fire.
- Establish drain piping according to the instructions of this manual.  
Inadequate piping may cause water damage.
- Tighten the flare nut according to the specified torque. A torque wrench should be used.  
If the flare nut is tightened too much, the flare nut may crack over time and cause refrigerant leakage.
- Do not touch the heat exchanger fins. ⊘  
Improper handling may result in injury.
- Be very careful about product transportation.  
Some products use PP bands for packaging. Do not use any PP bands for a means of transportation. It is dangerous.
- Make sure to provide for adequate measures in order to prevent that the outdoor unit be used as a shelter by small animals.  
Small animals making contact with electrical parts can cause malfunctions, smoke or fire. Please instruct the customer to keep the area around the unit clean.
- The temperature of refrigerant circuit will be high, please keep the inter-unit wire away from copper pipes that are not thermally insulated.
- Electrical work must be performed in accordance with the NEC/CEC by authorized personnel only.

# Accessories

Accessories supplied with the outdoor unit:

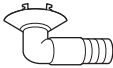
<p>Ⓐ Installation manual</p>	1	<p>Ⓑ Drain plug</p> <div style="text-align: center;">  </div> <p>The drain plug is located in the bottom of the packing case.</p>	1
------------------------------	---	---	---

# Precautions for Selecting the Location

- 1) Choose a place solid enough to bear the weight and vibration of the unit, where the operation sounds will not be amplified.
- 2) Choose a location where the hot air discharged from the unit or the operation sounds will not disturb the neighbors of the user.
- 3) Avoid installing near bedrooms so that operation sounds will not be a problem.
- 4) There must be sufficient space for carrying the unit into and out of the site.
- 5) There must be sufficient space for air passage and no obstructions around the air inlet and the air outlet.
- 6) The site must be free from the possibility of flammable gas leakage in a nearby place.
- 7) Install units, power cords and inter-unit wire at least 10ft (3m) away from television and radio sets. This is to prevent interference to images and sounds. (Noises may be heard even if they are more than 10ft (3m) away depending on radio wave conditions.)
- 8) In coastal areas or other places with salty atmosphere of sulfate gas, corrosion may shorten the life of the air conditioner.
- 9) Since drain flows out of the outdoor unit, do not place anything under the unit which must be kept away from moisture.

## NOTE

Cannot be installed hanging from ceiling or stacked.

## ⚠ CAUTION

When operating the air conditioner in a low outdoor ambient temperature, be sure to follow the instructions described below.

- To prevent exposure to wind, install the outdoor unit with its suction side facing the wall.
- Never install the outdoor unit at a site where the suction side may be exposed directly to wind.
- To prevent exposure to wind, it is recommended to install a baffle plate on the air discharge side of the outdoor unit.
- In heavy snowfall areas, select an installation site where the snow will not affect the unit.

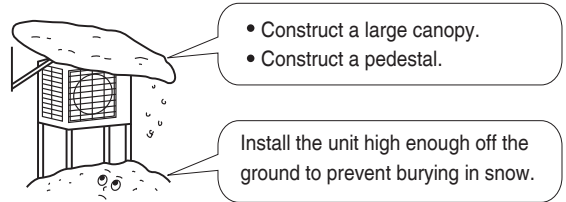

# Outdoor Unit Installation Drawings

Max. allowable piping length	65.6ft (20m)
** Min. allowable piping length	4.92ft (1.5m)
Max. allowable piping height	49.2ft (15m)
* Additional refrigerant required for refrigerant pipe exceeding 32.8ft (10m) in length.	0.21oz/ft (20g/m)
Gas pipe	O.D. 3/8 inch (9.5mm)
Liquid pipe	O.D. 1/4 inch (6.4mm)

- \* Be sure to add the proper amount of additional refrigerant. Failure to do so may result in reduced performance.
- \*\* The suggested shortest pipe length is 4.92ft (1.5m), in order to avoid noise from the outdoor unit and vibration. (Mechanical noise and vibration may occur depending on how the unit is installed and the environment in which it is used.) When connecting the FDXS12 indoor unit, the shortest piping length should be no less than 9.84ft (3m).

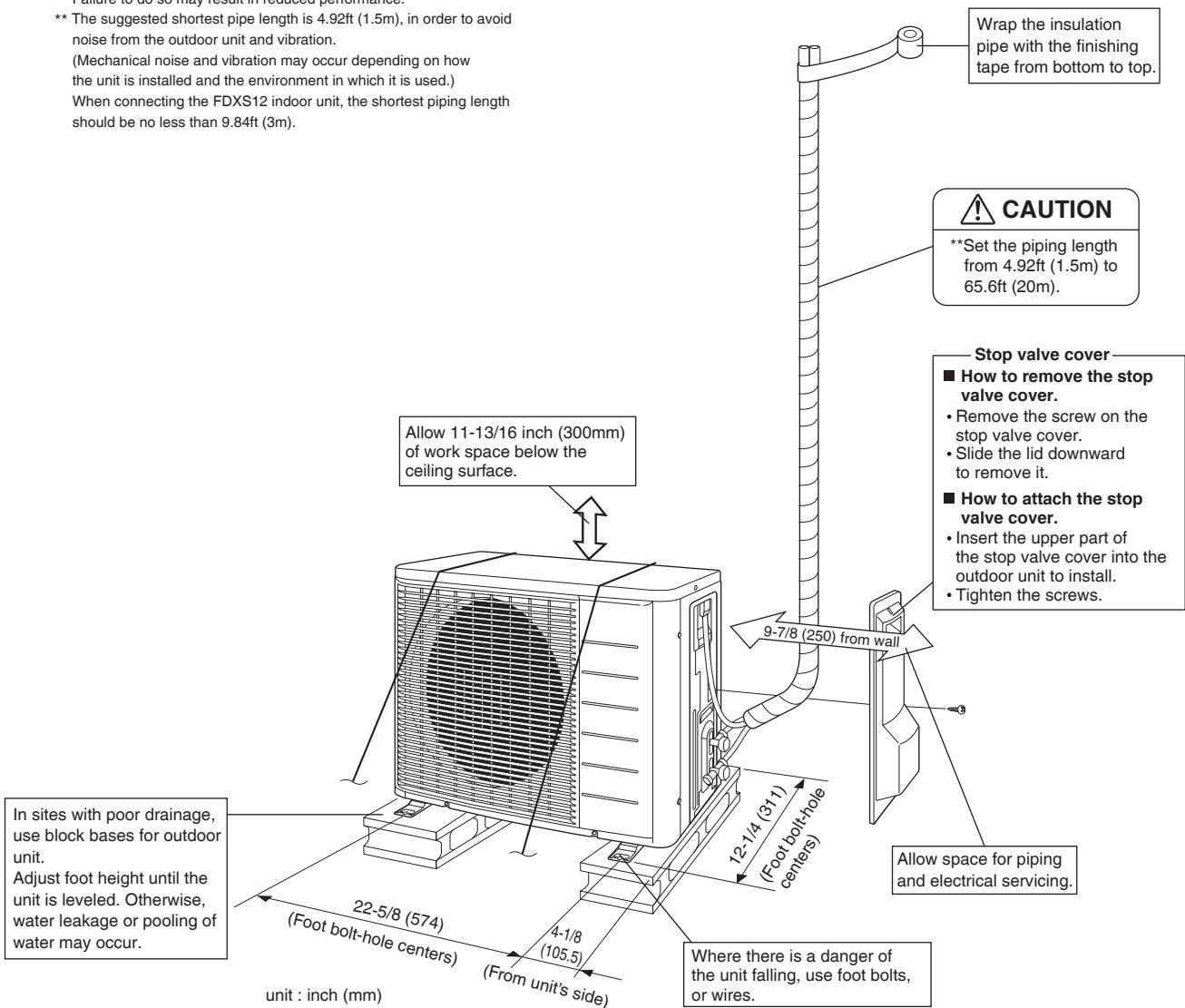

# Installation Guidelines

- Where a wall or other obstacle is in the path of outdoor unit's inlet or outlet airflow, follow the installation guidelines below.
- For any of the below installation patterns, the wall height on the outlet side should be 47-1/4 inch (1200mm) or less.

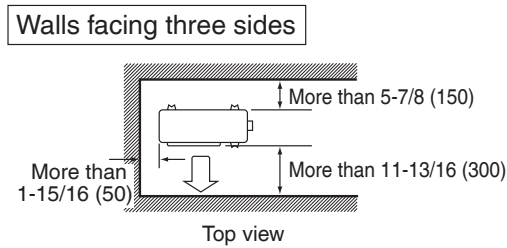
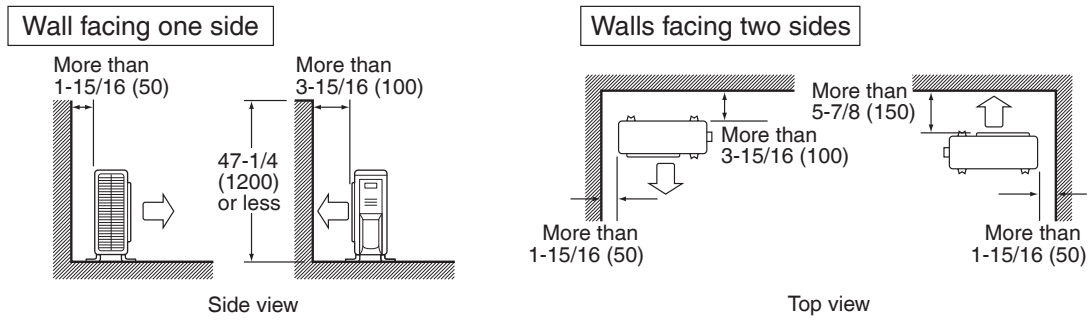

unit: inch (mm)

# Precautions on Installation

- Check the strength and level of the installation ground so that the unit will not cause any operating vibration or noise after installed.
- In accordance with the foundation drawing, fix the unit securely by means of the foundation bolts. (Prepare 4 sets of M8 or M10 foundation bolts, nuts and washers each which are available on the market.)
- It is best to screw in the foundation bolts until their ends are 3/4 inch (20mm) from the foundation surface.

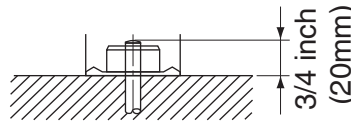

# Outdoor Unit Installation

## 1. Installing outdoor unit

- 1) When installing the outdoor unit, refer to "Precautions for Selecting the Location" and the "Outdoor Unit Installation Drawings".
- 2) If drain work is necessary, follow the procedures below.

## 2. Drain work

- 1) Use drain plug for drainage.
- 2) If the drain port is covered by a mounting base or floor surface, place additional foot bases of at least 1-1/4 inch (30mm) in height under the outdoor unit's feet.
- 3) In cold areas, do not use a drain hose with the outdoor unit. (Otherwise, drain water may freeze, impairing heating performance.)

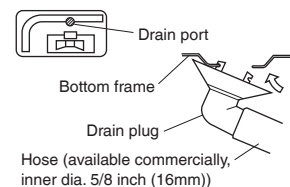

# Outdoor Unit Installation

## 3. Flaring the pipe end

- 1) Cut the pipe end with a pipe cutter.
- 2) Remove burrs with the cut surface facing downward so that the chips do not enter the pipe.
- 3) Put the flare nut on the pipe.
- 4) Flare the pipe.
- 5) Check that the flaring is properly made.

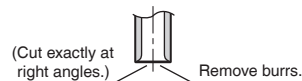

Flaring

Set exactly at the position shown below.

A	Flare tool for R410A		Conventional flare tool	
	Clutch-type	Clutch-type (Rigid-type)	Wing-nut type (Imperial-type)	
	0-0.020 inch (0-0.5mm)	0.039-0.059 inch (1.0-1.5mm)	0.059-0.079 inch (1.5-2.0mm)	

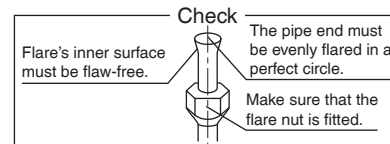

### ⚠ WARNING

- Do not use mineral oil on flared part.
- Prevent mineral oil from getting into the system as this would reduce the lifetime of the units.
- Never use piping which has been used for previous installations. Only use parts which are delivered with the unit.
- Never install a drier to this R410A unit in order to guarantee its lifetime.
- The drying material may dissolve and damage the system.
- Incomplete flaring may cause refrigerant gas leakage.

## 4. Refrigerant piping

### ⚠ CAUTION

- Use the flare nut fixed to the main unit to prevent it from cracking and deteriorating from age.
- To prevent gas leakage, apply refrigeration oil only to the inner surface of the flare. (Use refrigeration oil for R410A.)
- Use torque wrenches when tightening the flare nuts to prevent damage to the flare nuts and gas leakage.

- Align the centers of both flares and tighten the flare nuts 3 or 4 turns by hand. Then tighten them fully with the torque wrenches.

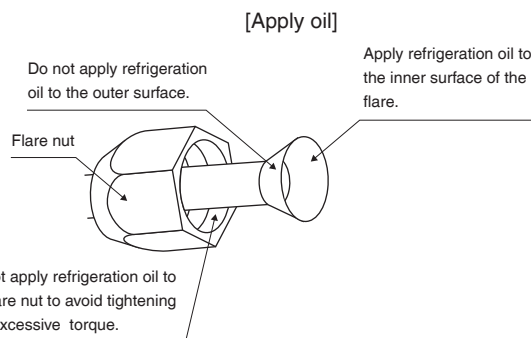

Flare nut tightening torque	
Gas side	Liquid side
3/8 inch (9.5mm)	1/4 inch (6.4mm)
24.1-29.4ft • lbf (32.7-39.9N • m)	10.4-12.7ft • lbf (14.2-17.2N • m)

Valve cap tightening torque	
Gas side	Liquid side
3/8 inch (9.5mm)	1/4 inch (6.4mm)
15.9-20.2ft • lbf (21.6-27.4N • m)	15.9-20.2ft • lbf (21.6-27.4N • m)

Service port cap tightening torque
7.9-10.8ft • lbf (10.8-14.7N • m)

## 5. Purging air and checking gas leakage

### ⚠ WARNING

- Do not mix any substance other than the specified refrigerant (R410A) into the refrigeration cycle.
- When refrigerant gas leaks occur, ventilate the room as soon and as much as possible.
- R410A, as well as other refrigerants, should always be recovered and never be released directly into the environment.
- Use a vacuum pump for R410A exclusively. Using the same vacuum pump for different refrigerants may damage the vacuum pump or the unit.

- When piping work is completed, it is necessary to purge the air and check for gas leakage.
- If using additional refrigerant, perform air purging from the refrigerant pipes and indoor unit using a vacuum pump, then charge additional refrigerant.
- Use a hexagonal wrench (3/16 inch (4mm)) to operate the stop valve rod.
- All refrigerant pipe joints should be tightened with a torque wrench at the specified tightening torque.

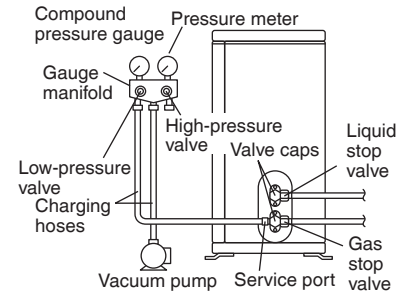

1) Connect projection side of charging hose (which comes from gauge manifold) to gas stop valve's service port.



2) Fully open gauge manifold's low-pressure valve (Lo) and completely close its high-pressure valve (Hi).  
(High-pressure valve subsequently requires no operation.)



3) Do vacuum pumping and make sure that the compound pressure gauge reads  $-29.9\text{inHg}$  ( $-0.1\text{MPa}$ ).<sup>\*1</sup>



4) Close gauge manifold's low-pressure valve (Lo) and stop vacuum pump.  
(Keep this state for a few minutes to make sure that the compound pressure gauge pointer does not swing back.)<sup>\*2</sup>



5) Remove caps from liquid stop valve and gas stop valve.



6) Turn the liquid stop valve's rod 90 degrees counterclockwise with a hexagonal wrench to open valve.  
Close it after 5 seconds, and check for gas leakage.  
Using soapy water, check for gas leakage from indoor unit's flare and outdoor unit's flare and valve rods.  
After the check is complete, wipe all soapy water off.



7) Disconnect charging hose from gas stop valve's service port, then fully open liquid and gas stop valves.  
(Do not attempt to turn valve rod beyond its stop.)



8) Tighten valve caps and service port caps for the liquid and gas stop valves with a torque wrench at the specified torques.

\*1. Pipe length vs. vacuum pump run time

Pipe length	Up to 49.2ft (15m)	More than 49.2ft (15m)
Run time	Not less than 10 min.	Not less than 15 min

\*2. If the compound pressure gauge pointer swings back, refrigerant may have water content or a loose pipe joint may exist. Check all pipe joints and retighten nuts as needed, then repeat steps 2) through 4).



# Outdoor Unit Installation

## 6. Refilling the refrigerant

Check the type of refrigerant to be used on the machine nameplate.

### Precautions when adding R410A

#### Fill from the gas pipe in liquid form.

It is a mixed refrigerant, so adding it in gas form may cause the refrigerant composition to change, preventing normal operation.

- 1) Before filling, check whether the cylinder has a siphon attached or not. (It should have something like "liquid filling siphon attached" displayed on it.)

Filling a cylinder with an attached siphon

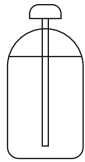

Stand the cylinder upright when filling.

(There is a siphon pipe inside, so the cylinder need not be upside-down to fill with liquid.)

Filling other cylinders



Turn the cylinder upside-down when filling.

- Be sure to use the R410A tools to ensure pressure and to prevent foreign objects entering.

## 7. Refrigerant piping work

### 7-1 Caution on pipe handling

- 1) Protect the open end of the pipe against dust and moisture.
- 2) All pipe bends should be as gentle as possible. Use a pipe bender for bending.

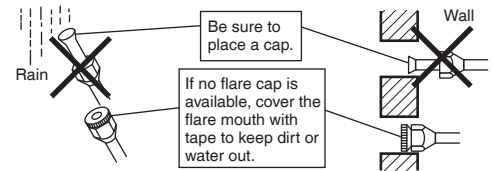

### 7-2 Selection of copper and heat insulation materials

When using commercial copper pipes and fittings, observe the following:

- 1) Insulation material: Polyethylene foam  
Heat transfer rate: 0.041 to 0.052W/mK (0.024 to 0.030Btu/ft<sup>2</sup>°F (0.035 to 0.045kcal/mh°C))  
Be sure to use insulation that is designed for use with HVAC Systems.
- 2) Be sure to insulate both the gas and liquid piping and to provide insulation dimensions as below.

Gas side	Liquid side	Gas pipe thermal insulation	Liquid pipe thermal insulation
O.D. 3/8 inch (9.5mm)	O.D. 1/4 inch (6.4mm)	I.D. 15/32-19/32 inch (12-15mm)	I.D. 5/16-13/32 inch (8-10mm)
Minimum bend radius		Thickness 13/32 inch (10mm) Min.	
1-3/16 inch (30mm) or more			
Thickness 0.031 inch (0.8mm) (C1220T-O)			

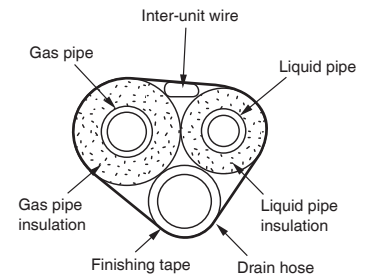

- Use separate thermal insulation pipes for gas and liquid refrigerant pipes.

# Pump Down Operation

In order to protect the environment, be sure to pump down when relocating or disposing of the unit.

- 1) Remove the valve cap from liquid stop valve and gas stop valve.
- 2) Carry out forced cooling operation.
- 3) After 5 to 10 minutes, close the liquid stop valve with a hexagonal wrench.
- 4) After 2 to 3 minutes, close the gas stop valve and stop forced cooling operation.

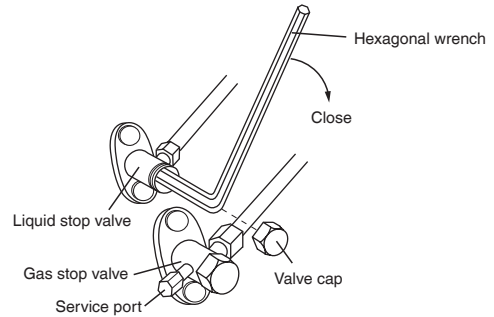

## Forced cooling operation

### ■ Using the indoor unit ON/OFF switch

Press the indoor unit ON/OFF switch for at least 5 seconds. (The operation will start.)

- Forced cooling operation will stop automatically after around 15 minutes. To stop the operation, press the indoor unit ON/OFF switch.

### ■ Using the indoor unit's remote controller

- 1) Press "MODE" button and select the cooling mode.
  - 2) Press "ON/OFF" button to turn on the system.
  - 3) Press both of "TEMP" button and "MODE" button at the same time.
  - 4) Press "MODE" button twice. (7 will be displayed and the unit will enter forced cooling operation.)
- Forced cooling operation will stop automatically after around 30 minutes. To stop the operation, press "ON/OFF" button.

# Wiring

## ⚠ WARNING

- Do not use tapped wires, stranded wires, extension cords, or starburst connections, as they may cause overheating, electrical shock, or fire.
- Do not use locally purchased electrical parts inside the product. (Do not branch the power for the drain pump, etc., from the terminal block.) Doing so may cause electric shock or fire.
- Be sure to install a ground fault circuit interrupter breaker. (One that can handle higher harmonics.) (This unit uses an inverter, which means that it must be used a ground fault circuit interrupter breaker capable handling harmonics in order to prevent malfunctioning of the ground fault circuit interrupter breaker itself.)
- Use an all-pole disconnection type breaker with at least 1/8 inch (3mm) between the contact point gaps.
- When carrying out wiring connection, take care not to pull at the conduit.
- Do not connect the power wire to the indoor unit. Doing so may cause electric shock or fire.

- Do not turn on the safety breaker until all work is completed.

- 1) Strip the insulation from the wire (3/4inch (20mm)).
- 2) Connect the connection wires between the indoor and outdoor units so that the terminal numbers match. Tighten the terminal screws securely. We recommend a flathead screwdriver be used to tighten the screws.

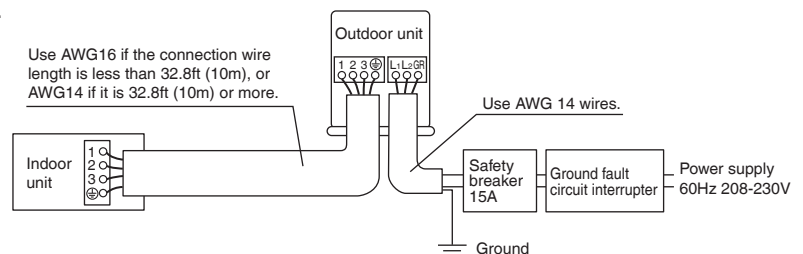

# Wiring

## <Method of mounting conduit>

- 1) Pass wires through the conduit and secure them with a lock nut.
- 2) After completing the work, reattach the conduit mounting cover and the protection plate to its original position.

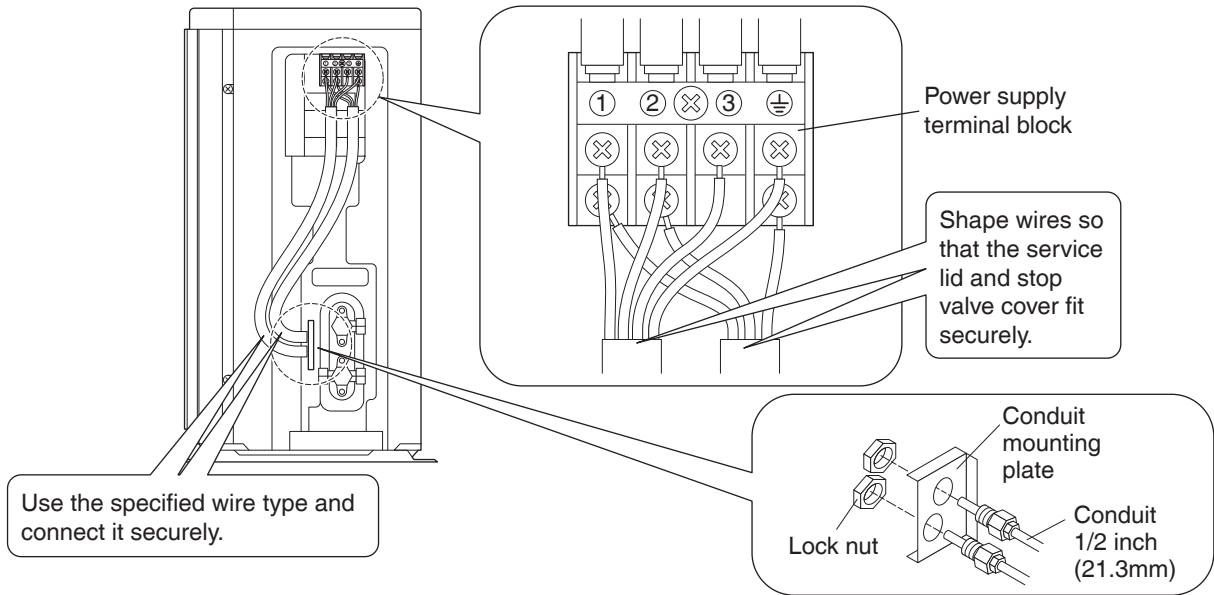

Use the specified wire type and connect it securely.

Power supply terminal block

Shape wires so that the service lid and stop valve cover fit securely.

Conduit mounting plate  
Lock nut  
Conduit 1/2 inch (21.3mm)

Observe the notes mentioned following when wiring to the power supply terminal block.  
Precautions to be taken for power supply wiring.

### ⚠ CAUTION

- When connecting the connection wires to the terminal block using a single core wire, be sure to perform curling. Problems with the work may cause heat and fires.

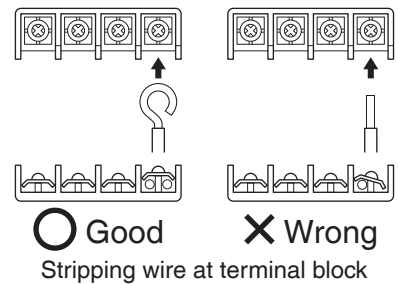
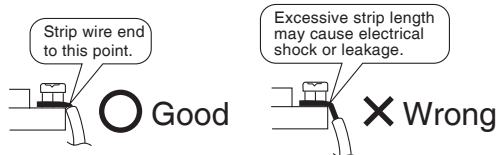

- If the stranded wires must be used, make sure to use the round crimp-style terminal for connection to the power supply terminal block. Place the round crimp-style terminals on the wires up to the covered part and secure in place.

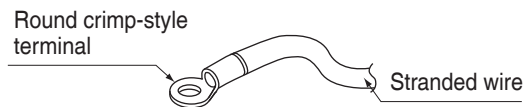

- 3) Pull the wire and make sure that it does not disconnect. Then fix the wire in place with a wire stop.

# Facility Setting (cooling at low outdoor temperature)

This function is designed for facilities such as equipment or computer rooms. It is never to be used in a residence or office where people occupy the space.

- Cutting jumper 4 (J4) on the circuit board will expand the operation range down to 14°F (-10°C). However it will stop if the outdoor temperature drops below -0.4°F (-18°C) and start back up once the temperature rises again.

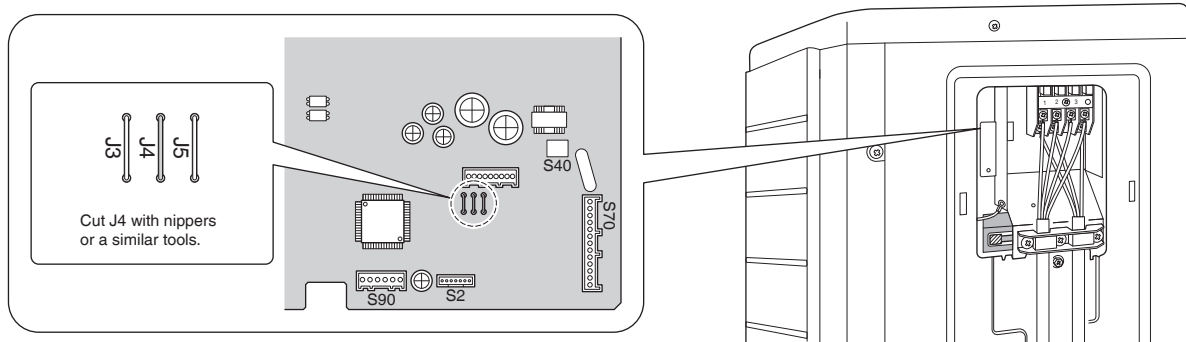

## **⚠ CAUTION**

- If the outdoor unit is installed where the heat exchanger of the unit is exposed to direct wind, provide a windbreak wall.
- Intermittent noises may be produced by the indoor unit due to the outdoor fan turning on and off when using facility settings.
- Do not place humidifiers or other items which might raise the humidity in rooms where facility settings are being used. A humidifier might cause dew condensation from the indoor unit outlet vent.
- Cutting jumper 4 (J4) sets the indoor fan tap to the highest position. Notify the user about this.

# Trial Operation and Testing

## 1. Trial operation and testing

1-1 Measure the supply voltage and make sure that it falls in the specified range.

1-2 Trial operation should be carried out in either cooling or heating mode.

- In cooling mode, select the lowest programmable temperature; in heating mode, select the highest programmable temperature.
  - 1) Trial operation may be disabled in either mode depending on the room temperature.
  - 2) After trial operation is complete, set the temperature to a normal level (78°F to 82°F (26°C to 28°C) in cooling mode, 68°F to 75°F (20°C to 24°C) in heating mode).
  - 3) For protection, the system disables restart operation for 3 minutes after it is turned off.

1-3 Carry out the test operation in accordance with the operation manual to ensure that all functions and parts, such as fin movement, are working properly.

- The air conditioner requires a small amount of power in its standby mode. If the system is not to be used for some time after installation, shut off the circuit breaker to eliminate unnecessary power consumption.
- If the circuit breaker trips to shut off the power to the air conditioner, the system will restore the original operation mode when the circuit breaker is opened again.

## 2. Test items

Test items	Symptom	Check
Indoor and outdoor units are installed properly on solid bases.	Fall, vibration, noise	
No refrigerant gas leaks.	Incomplete cooling/heating function	
Refrigerant gas and liquid pipes and indoor drain hose extension are thermally insulated.	Water leakage	
Draining line is properly installed.	Water leakage	
System is properly grounded.	Electrical leakage	
The specified wires are used for inter-unit wiring.	Inoperative or burn damage	
Indoor or outdoor unit's air inlet or air outlet has clear path of air. Stop valves are opened.	Incomplete cooling/heating function	
Indoor unit properly receives remote control commands.	Inoperative	

**DAIKIN AC (AMERICAS), INC.**

1645 Wallace Drive, Suite 110  
Carrollton, TX75006

info@daikinac.com  
www.daikinac.com

**DAIKIN INDUSTRIES, LTD.**

Head office:

Umeda Center Bldg., 2-4-12, Nakazaki-Nishi,  
Kita-ku, Osaka, 530-8323 Japan

Tokyo office:

JR Shinagawa East Bldg., 2-18-1, Konan,  
Minato-ku, Tokyo, 108-0075 Japan



Two-dimensional bar code is a code for manufacturing.

3P300674-1B

M11B134A (1209) 