

OPERATION MANUAL

SPLIT SYSTEM

Air Conditioners

MODELS

Ceiling-mounted Duct type

FBA18AAVJU
FBA24AAVJU
FBA30AAVJU
FBA36AAVJU
FBA42AAVJU
FBA48AAVJU

English

Français

Español



Please visit <http://www.daikinac.com/content/resources/manuals> for the most current version of operation manual. In the event of conflicting information, the online contents are to be used.

Veillez visiter <http://www.daikinac.com/content/resources/manuals> pour obtenir la version la plus récente du mode d'emploi. En cas de conflit d'informations, le contenu en ligne est à privilégier.

Visite <http://www.daikinac.com/content/resources/manuals> para obtener la versión más actualizada del manual de operación en español. En caso de información contradictoria, deberán utilizarse los contenidos en línea.





SAFETY CONSIDERATIONS

Refer also to the General safety considerations attached to the outdoor unit.

	Read the safety considerations in this manual carefully before operating the unit.
 Refrigerant Safety Group A2L	This appliance is filled with R32.

Read these **Safety Considerations for Operations** carefully before operating air conditioning equipment. Make sure that the unit operates properly during the startup operation. Instruct the customer on how to operate and maintain the unit. Inform customers that they should store this Operation Manual with the Installation Manual and General Safety Considerations for future reference.

Meanings of **DANGER**, **WARNING**, **CAUTION**, and **NOTE** Symbols:

-  **DANGER**.....Indicates an imminently hazardous situation which, if not avoided, will result in death or serious injury.
-  **WARNING**.....Indicates a potentially hazardous situation which, if not avoided, could result in death or serious injury.
-  **CAUTION**.....Indicates a potentially hazardous situation which, if not avoided, may result in minor or moderate injury. It may also be used to alert against unsafe practices.
-  **NOTE**.....Indicates situations that may result in equipment or property-damage accidents only.

DANGER

- Do not install the unit in an area where flammable materials are present due to risk of explosion resulting in serious injury or death.
- Any abnormalities in the operation of the air conditioner such as smoke or fire could result in severe injury or death. Turn off the power and contact your dealer immediately.
- Refrigerant gas may produce toxic gas if it comes in contact with fire, such as from a fan, heater, stove, or cooking device. Exposure to this gas could cause severe injury or death.
- For refrigerant leakage, consult your dealer. Refrigerant gas is heavier than air and replaces oxygen. A massive leak could lead to oxygen depletion, especially in basements, and an asphyxiation hazard could occur leading to serious injury or death.
- If equipment utilizing a burner is used in the same room as the air conditioner, there is the danger of oxygen deficiency which could lead to an asphyxiation hazard resulting in serious injury or death. Be sure to ventilate the room sufficiently to avoid this hazard.
- Safely dispose of the packing materials. Packing materials, such as nails and other metal or wooden parts, may cause stabs or other injury.
- Tear apart and throw away plastic packaging bags so that children can not play with them. Children playing with plastic bags face the danger of death by suffocation.

WARNING

- Contact your dealer for repair and maintenance. Improper repair and maintenance may result in water leakage, electric shock or fire. Only use accessories made by Daikin that are specifically designed for use with the equipment and have them installed by a professional.
- Contact your dealer to move and reinstall the air conditioner. Incomplete installation may result in water leakage, electric shock or fire.
- Never let the indoor unit or the remote controller get wet. Water can cause an electric shock or fire.
- Never use flammable spray such as hair spray, lacquer, or paint near the unit. Flammable spray may cause fire.
- When a fuse blows out, never replace it with one of incorrect ampere ratings or different wires.
- Never inspect or service the unit by yourself. Contact a qualified service person to perform this work.
- Turn off all electrical power before doing any maintenance to avoid the risk of serious electric shock; never sprinkle or spill water or liquids on the unit. Do not touch the switch with wet fingers. Touching a switch with wet fingers can cause electric shock.
- Do not allow children to play on or around the unit to prevent injury.
- The heat exchanger fins are sharp enough to cut. To avoid injury wear gloves or cover the fins while working around them.
- Do not put a finger or other objects into the suction or discharge. The fan is rotating at high speed and may cause injury.
- Check the unit foundation for damage on a continuous basis, especially if it has been in use for a long time. If left in a damaged condition the unit may fall and cause injury.
- Placing a flower vase or other containers with water or other liquids on the unit could cause electric shock or fire if a spill occurs.
- Do not touch the discharge or horizontal blades while the swing flap is in operation because fingers could get caught and injured.
- Never touch the internal parts of the controller. Do not remove the control box cover because some parts inside are dangerous to touch. To check and adjust internal parts, contact your dealer.
- Be sure to ground the unit. Do not ground the unit to an utility pipe, arrester, or telephone ground. Incomplete grounding may cause electric shock or fire. A high surge current from lightning or other sources may cause damage to the air conditioner.
- This equipment can be installed with a Ground-Fault Circuit Breaker (GFCI). Although this is a recognized measure for additional protection, with the grounding system in North America, a dedicated GFCI is not necessary.
- Do not turn off the power to air conditioners or connected devices (detectors and alarms, mechanical ventilators, safety shut-off valves, etc.) except when replacing parts or conducting inspections. Failure to detect a refrigerant leakage may result in a fire.
- Consult your dealer when making changes to the room layout or partitions. It will be necessary to re-examine safety measures required in managing refrigerant leakages. Failure to implement the necessary safety measures may lead to flammable concentrations.



CAUTION

- Do not use the air conditioner for any other purposes other than comfort cooling or heating. Do not use the unit for cooling precision instruments, food, plants, animals or works of art.
- Do not place items under the indoor unit as they may be damaged by condensates that may form if the humidity is above 80% or if the drain outlet gets blocked.
- Before cleaning, stop the operation of the unit by turning the power off or by pulling the supply cord out from its receptacle. Otherwise, electric shock or injury may result.
- Do not wash the air conditioner with excessive water. An electric shock or fire may result.
- Avoid placing the controller in a spot splashed with water. Water entering the controller may cause an electric shock or damage the internal electronic parts.
- Do not operate the air conditioner when using a room fumigation type of insecticide. Failure to observe this could cause the chemicals to be deposited in the unit and can endanger the health of those who are hypersensitive to chemicals.
- Do not turn off the power immediately after stopping operation. Always wait for at least 5 minutes before turning off the power. Otherwise, water leakage may occur.
- This appliance is not intended for use by persons (including children) with reduced physical, sensory or mental capabilities, or lack of experience and knowledge, unless they have been given supervision or instruction concerning use of the appliance by a person responsible for their safety.
- The remote controller should be kept away from children so they cannot play with it.
- Consult with the installation contractor for cleaning.
- Incorrect cleaning of the inside of the air conditioner could make the plastics parts break and cause water leakage or electric shock.
- Do not touch the suction or aluminum fin of the air conditioner as they can cut and cause injury.
- Do not place objects in direct proximity of the outdoor unit. Do not let leaves and other debris accumulate around the unit. Leaves are a hotbed for small animals which can enter the unit. Once inside the unit, animals can cause the unit to malfunction, and cause smoke or fire when they make contact with electrical parts.



NOTE

- Never press the button of the remote controller with a hard, pointed object. The remote controller may be damaged.
- Never pull or twist the electric wire of the remote controller. It may cause the unit to malfunction.
- Do not place appliances that produce open flames in places that are exposed to the airflow of the unit or under the indoor unit. It may cause incomplete combustion or deformation of the unit due to the heat.
- Do not expose the controller to direct sunlight. The LCD display can become discolored and may fail to display the data.

- Do not wipe the controller operation panel with benzene, thinner, chemical dust cloth, etc. The panel may get discolored or the coating can peel off. If it is heavily dirty, soak a cloth in water-diluted neutral detergent, squeeze it well and wipe the panel clean. Then wipe it with another dry cloth.
- Dismantling of the unit, disposal of the refrigerant, oil, and additional parts, should be done in accordance with the relevant local, state, and national regulations.
- Operate the air conditioner in a sufficiently ventilated area and not surrounded by obstacles. Do not use the air conditioner in the following places.
 - a. Places with a mist of mineral oil, such as cutting oil.
 - b. Locations such as coastal areas where there is a lot of salt in the air.
 - c. Locations such as hot springs where there is a lot of sulfur in the air.
 - d. Locations such as factories where the power voltage varies a lot.
 - e. In cars, boats, and other vehicles.
 - f. Locations such as kitchens where oil may splatter or where there is steam in the air.
 - g. Locations where equipment produces electromagnetic waves.
 - h. Places with an acid or alkaline mist.
 - i. Places where fallen leaves can accumulate or where weeds can grow.
- Do not attempt to do electrical work or grounding work unless you are licensed to do so. Consult with your dealer for electrical work and grounding work.
- Consult your dealer if the air conditioner in operation generates unusual noise.
- Make sure that the drainpipe is installed properly to drain water. If no water is discharged from the drainpipe while the air conditioner is in the cooling mode, the drainpipe may be clogged with dust or dirt and water leakage from the indoor unit may occur. Stop operating the air conditioner and contact your dealer.
- A refrigerant sensor is mounted in the indoor units. Do not use gas appliances using flammable gas (propane, butane, methane, etc.), sprays using flammable gas (LPG, etc.) such as insecticide or hair spray, smoke, medical agent and paint in the vicinity. If it reacts, a malfunction code is displayed and the operation may not be able to be performed.
- Once the refrigerant sensor reacts, it needs to be replaced with a new one.
- When the refrigerant sensor detects the sensitivity decreased, a malfunction code is displayed and the operation cannot be performed. So, the sensor will need to be replaced with a new one.

CONTENTS

SAFETY CONSIDERATIONS	[i] [ii]
1. NAMES AND FUNCTIONS OF PARTS	1
2. OPTIMUM OPERATION	1
3. MAINTENANCE (FOR SERVICE PERSONNEL)	2
4. PROPER OPERATION OF THE AIR CONDITIONER	3
5. TROUBLE SHOOTING	3

1. NAMES AND FUNCTIONS OF PARTS

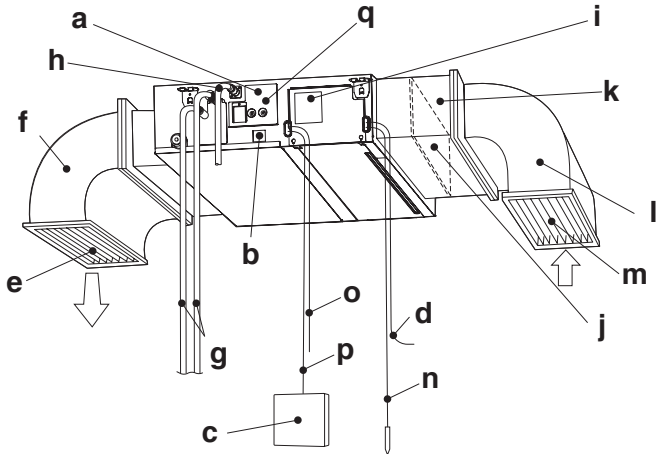

a	Drain pump (Built-in)
b	Drain pan inspection window
c	Remote controller (Optional accessory) Depending on the system configuration, the remote controller is not provided.
d	Power supply wiring
e	Discharge grille
f	Discharge duct
g	Refrigerant piping
h	Drain piping
i	Name plate
j	Air filter (Optional accessory)
k	Suction filter chamber
l	Suction duct
m	Suction grille
n	Ground wiring The wiring passes electricity from the indoor unit to the earth to prevent accidental electric shock.
o	Transmission wiring
p	Remote controller wiring
q	Refrigerant sensor (Built-in)

2. OPTIMUM OPERATION

Observe the following precautions to ensure the system operates.

- Adjust the room temperature properly for a comfortable environment. Avoid excessive heating or cooling.
- Prevent direct sunlight from entering a room during cooling operation by using curtains or blinds.
- Ventilate the room regularly.
Using the unit for long periods of time requires attentive ventilation of the room.
- Keep doors and windows closed. If the doors and windows remain open, room air will escape and diminish performance of cooling and heating operation.
- Do not place other heaters directly below the indoor unit. They may deform due to the heat.
- Do not block the air inlet or air outlet of the unit as it will cause a decrease in performance or stop operation.
- Turn off the main power supply switch when it is not used for long periods of time. When the main power switch is turned on, some watts of electricity is being used even if the system is not operating. Turn off the main power supply switch for saving energy. When reoperating, turn on the main power supply switch 6 hours before operation for smooth running (Refer to MAINTENANCE).
- When the display shows "Time to clean filter" ask a qualified service person to clean the filter (Refer to MAINTENANCE).
- Fully use the function of airflow direction adjust.
Cold air gathers on the floor, and warm air gathers in the ceiling.
Set the airflow direction parallel during cooling or dry operation, and set it downwards during heating operation.
Do not let the air blow directly to a person.
- It takes time for the room temperature to reach the set temperature.
We recommend starting the operation in advance using timer operation.

3. MAINTENANCE (FOR SERVICE PERSONNEL)

ONLY A QUALIFIED SERVICE PERSON IS ALLOWED TO PERFORM MAINTENANCE

⚠ WARNING

- Do not use flammable gas (such as hair sprays and insecticides) near the air conditioner.
- Do not wipe the air conditioner with benzene or thinner. It may cause cracks, electric shock or fire.

⚠ CAUTION

- Do not wash the air conditioner with water. It may cause electric shock or fire due to leakage.
- Make sure to turn off the air conditioner when taking care of the air conditioner and disconnect the power supply breaker.
Unless the power supply is disconnected, it may cause electric shock or injury.
If the refrigerant sensor detects a refrigerant leakage, the fan may suddenly start rotating even though operation is stopped.
- When working at a high place, give caution to your footing.
If the scaffold is unstable, it may cause injuries due to fall and stumbling.

HOW TO CLEAN THE AIR FILTER

When the remote controller indicates the filter sign, clean the air filter.

- The indication is made after the system runs for a defined period of time.

NOTE

- You may change the time of indicating the filter sign.
If the indoor unit is used in a space where the air is more contaminated, ask your local dealer for solution.

Dust level	Time until indication is displayed
Normal	2500 hours (equivalent to one year)
More contaminated	1250 hours (equivalent to a half year)

- If it becomes difficult to remove dust from the air filter, replace the air filter.
(The replacement air filter is an optional accessory.)

Increase the frequency of cleaning if the unit is installed in a room where the air is extremely contaminated.

NOTE

- Do not remove the air filter except when cleaning. Unnecessary handling may damage the filter.
(This product is not provided with an air filter as a standard accessory.)
- Do not attach objects other than the genuine air filter (e.g., kitchen paper) to the suction.
Otherwise, the performance of the air conditioner will be degraded, and icing or water leakage may result.
- Request a special contractor for the cleaning of the air filter.
- **Be sure to use the optional filter chamber.**
Request your dealer for the installation of the filter chamber.
- Be sure to clean the air filter at the beginning of the cooling or heating season.
(A decrease in the airflow volume of the air conditioner will result and the performance of the air conditioner will be degraded if the air filter is clogged with dust or dirt.)

After completing cleaning and installing the air filter, turn off the indicating the filter sign on the remote controller.

- The indication can be turned off whether in operation or at stop.
- For details, refer to the operation manual attached to the remote controller.

HOW TO CLEAN DISCHARGE, OUTSIDE PANELS AND REMOTE CONTROLLER

1. Clean with soft cloth.
2. When it is difficult to remove stains, use water or neutral detergent.

NOTE

- Do not wash the suction grille with water of 122°F (50°C) or higher.
It may cause discoloration and deformation.
- When drying the suction grille, do not heat it with fire. It may cause burning.
- Do not use substances such as gasoline, benzene, thinner, polishing powder and liquid insecticide sold in the market.
It may cause discoloration and deformation.

WHAT TO DO WHEN START UP AFTER A LONG PERIOD OF NO USE

Confirm the following

- Check that the suction and discharge of indoor and outdoor units are not blocked.
Remove any obstacle.
Obstacles decrease the airflow, and cause performance decrease and may damage the unit.

Clean the air filter

- After cleaning the air filter, make sure to reinstall it.
(Refer to "3. MAINTENANCE" on page 2.)
- For information on how to install, remove, or clean the optional air filter, refer to the user's manual attached to the air filter.
- Turn off the indicating the filter sign displayed on the remote controller after turning on the power.
The indication can be turned off whether in operation or at stop.
- For details, refer to the operation manual attached to the remote controller.

Turn on the power circuit breaker at least 6 hours before operation.

- This is required in order to activate the air conditioner smoothly, and to protect air conditioner.
- The display on the remote controller will be shown when the power circuit breaker is turned on.

4. PROPER OPERATION OF THE AIR CONDITIONER

The following symptoms do not indicate air conditioner malfunction

I. THE SYSTEM DOES NOT OPERATE

- **The system does not restart immediately after the ON/OFF button is pressed.**

If the OPERATION lamp lights, the system is in normal condition.

It does not restart immediately because a safety device operates to prevent overload of the system. After 3 minutes, the system will turn on again automatically.

- **The system does not restart immediately when TEMPERATURE SETTING button is returned to the former position after pushing the button.**

If the OPERATION lamp lights, the system is in normal condition.

It does not restart immediately because a safety device operates to prevent overload of the system. After 3 minutes, the system will turn on again automatically.

- **The system does not start when the display shows "CENTRAL CONTROL" and it flashes for a few seconds after pressing an operation button.**

This is because the system is under centralized control. Flashes on the display indicates that the system cannot be controlled by the remote controller.

- **The system does not start immediately after the power supply is turned on.**

Wait one minute until the micro computer is ready for operation.

II. WHITE MIST COMES OUT OF THE UNIT

- **When humidity is high during cooling operation. (In oily or dusty places)**

If the inside of an indoor unit is extremely contaminated, the temperature distribution inside a room becomes uneven. It is necessary to clean the inside of the indoor unit. Ask your Daikin dealer for details on cleaning the unit. This operation requires a qualified service person.

- **When the system is changed over to HEATING OPERATION after DEFROST OPERATION.**

Moisture generated by DEFROST becomes steam.

III. NOISE OF AIR CONDITIONERS

- **A ringing sound after the unit is started.**

This is the starting sound of the motor which moves the airflow direction blades.

It will quiet down after about one minute.

- **A continuous "Whoosh" is heard when the system is in COOLING or DEFROST OPERATION.**

This is the sound of refrigerant gas flowing through both indoor and outdoor units.

- **A "Whoosh" sound is heard at the start or immediately after the stop of operation and at the start or immediately after the stop of DEFROST OPERATION.**

This is the noise of refrigerant caused by flow stop and flow change.

- **A continuous flow "Whoosh" sound is heard when the system is in COOLING OPERATION or at a stop.**

The noise is heard when the drain pump is in operation.

IV. DUST FROM THE UNIT

- **Dust may blow out from the unit after starting operation after not being used for a while.**
Dust absorbed by the unit blows out.

V. THE UNIT GIVES OFF ODORS

The unit absorbs odors in the room, furniture, cigarettes, etc., and then emits them.

VI. THE LIQUID CRYSTAL OF THE REMOTE CONTROLLER DISPLAY "Checking the connection. Please stand by"

- **This occurs immediately after the main power supply switch is turned on.**
This indicates that the remote controller is in normal condition and continues temporarily.

5. TROUBLE SHOOTING

I. If one of the following malfunctions occurs, take the measures shown below and contact your Daikin dealer.

The system must be repaired by a qualified service person.

— ⚠ WARNING —

If the air conditioner is operating abnormally, such as a burning smell, unplug the power cord from the outlet, and contact your dealer

Continued operation under such circumstances may result in a failure, electric shock or fire.

- If a safety device such as a fuse, a breaker or a ground fault circuit interrupter frequently actuates;
Procedure: Do not turn on the main power switch, take the following actions.
- If the ON/OFF switch does not properly work;
Procedure: Turn off the main power switch.
- If water leaks from unit.
Procedure: Stop the operation.

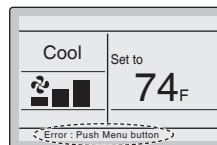

- If an error occurs, either one of the following items will flash in the basic screen.
"Error: Push Menu button"
* The operation lamp will flash.
"Warning: Push Menu button"
* The operation lamp will not flash.
Press Menu / OK button.

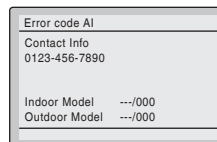
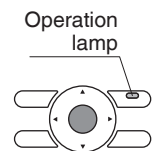

- The error code will flash and the service contact and model name or code may appear.
- Notify your Daikin dealer of the Error code and model name or code.

II. If the system does not properly operate (except for the above mentioned case), and none of the other mentioned malfunctions are evident, investigate the system according to the following procedures.

1. If the system does not operate at all.

- Check if there is a power failure.
Wait until power is restored. If power failure occurs during operation, the system automatically restarts immediately after the power supply recovers.
- Check if no fuse has blown.
Turn off the power supply.
- Check if the breaker is blown.
Turn the power on with the breaker switch in the off position.
Do not turn the power on with the breaker switch in the trip position.
(Contact your dealer.)

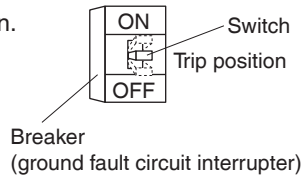

2. If the system stops operating after it has been running normally.

- Check if the air inlet or outlet of outdoor or indoor unit is blocked by obstacles.
Remove the obstacle and make it well-ventilated.
- Check if the air filter is clogged.
Ask a qualified service person to clean the air filters (Refer to MAINTENANCE).

3. The system operates but it does not sufficiently cool or heat, check if:

- If the air inlet or outlet of the indoor or the outdoor unit is blocked with obstacles.
Remove the obstacle and make it well-ventilated.
- If the air filter is clogged.
Ask a qualified service person to clean the air filters (Refer to MAINTENANCE).
- If the set temperature is not adequate.
- If the FAN SPEED button is set to LOW SPEED.
- If the airflow angle is not adequate.
- If the doors or the windows are open. Shut doors or windows to prevent outside air from coming in.
- If direct sunlight enters the room (when cooling).
Use curtains or blinds.
- When there are too many inhabitants in the room (when cooling).
Cooling effect decreases if heat gain of the room is too large.
- If the heat source of the room is excessive (when cooling).
Cooling effect decreases if heat gain of the room is too large.

DAIKIN COMFORT TECHNOLOGIES MANUFACTURING, L.P.

Daikin Texas Technology Park,
19001 Kermier Road,
Waller, TX, 77484, U.S.A.

