



# CATALOG

SINGLE & MULTI-ZONE SYSTEMS  
SKYAIR PRODUCTS  
RESIDENTIAL

# Daikin is one of the largest manufacturers of heating, cooling and refrigerant products in the world.

**Daikin is recognized as one of the world leaders in the manufacture of HVAC equipment and refrigerants.** For almost 100 years, Daikin has grown consistently and successfully due to the loyalty and success of our customers, as well as a track record of innovation and quality. Daikin is redefining home comfort in North America with some of the most technologically and aesthetically advanced solutions. These intelligent, energy efficient systems provide an unprecedented level of individual comfort and control.

**Daikin is expansive in its manufacturing footprint. It is global, but with a local focus. We have operations around the world, with research and development, as well as production facilities in over 150 countries.** Using our advanced technology and expertise, Daikin has earned a reputation for excellence as an indoor comfort specialist in countries and regions spanning the globe by providing solutions for the needs of our customers. In the United States, located just outside of Houston, Texas, the Daikin Texas Technology Park allows Daikin to consolidate manufacturing, engineering, logistics, marketing and sales in one location. The facility is designed to better serve customers, employees, and the environment.

#### **Additional Information**

Before purchasing this appliance, read important information about its estimated annual energy consumption, yearly operating cost, or energy efficiency rating that is available from your retailer.

# Table of Contents

Warranty Overview	4	<b>Split Systems</b>	
Efficiency Standards – National and Regional	5	<b>Air Conditioners</b>	
Regional Efficiency Standards	6	DX9VC (Up to 22.5 SEER2)	116
Why Zoned Systems?	8	DX7TC (Up to 17.2 SEER2)	117
Daikin Benefits	9	DX6VS (Up to 17.2 SEER2)	118
R-32 Refrigerant	10	DX5SE (Up to 15.2 SEER2)	119
Nomenclature	11	DX4SE (14.3 SEER2)	120
Key Features and Benefits	12	DX4SQ (14.3 SEER2)	121
Single and Multi-Zone System Overview	14	DX3SE (13.4 SEER2)	122
Zoned System Features	15	DX3SQ (13.4 SEER2)	123
Innovative Control Solutions	16	<b>Heat Pumps</b>	
<b>Single Zone Systems</b>	<b>19</b>	DZ9VC (Up to 22.5 SEER2 & Up to 8.2 HSPF)	124
Daikin 17 series Wall-Mounted	20	DZ7TC (Up to 17.2 SEER2 & 8.2 HSPF2)	125
Daikin 19 series Wall-Mounted	24	DZ6VS (Up to 17.5 SEER2 & 8.5 HSPF2)	126
Daikin <i>EMURA</i> Wall-Mounted	28	DZ5SE (Up to 15.2 SEER2 & 7.8 HSPF2)	127
Daikin <i>AURORA</i> Wall-Mounted	30	DZ4SE (14.3 SEER2 & 7.5 HSPF2)	128
Daikin <i>AURORA</i> Floor-Mounted	32	DZ4SQ (14.3 SEER2 & 7.5 HSPF2)	129
Daikin <i>AURORA</i> FDMQ Ducted Concealed	34	<b>Gas Furnaces</b>	
Daikin <i>VISTA</i> Ceiling Cassette	36	<b>90% AFUE</b>	
Daikin LV series Wall-Mounted	38	DM97MC (Up to 97% AFUE)	132
Daikin LV series Slim-Duct Concealed Ceiling Unit	40	DC97MC (Up to 97% AFUE)	133
Daikin FDMQ Ducted Concealed Indoor Unit	42	DM96VC (Up to 96% AFUE)	134
Daikin NV series Wall-Mounted	44	DC96VC (Up to 96% AFUE)	135
Daikin LV 30/36 series Wall-Mounted	48	DM96SC-U (Up to 96% AFUE)	136
Daikin <i>ATMOSPHERA</i>	50	DM96TN (Up to 96% AFUE)	137
<b>Multi-Zone Systems</b>	<b>51</b>	DC96TN (Up to 96% AFUE)	138
Daikin <i>AURORA</i> Multi-Zone Outdoor Units	56	DM96SN / DM96SN-U (Up to 96% AFUE)	139
Daikin MXS series Multi-Zone Outdoor Units	58	DC96SN (Up to 96% AFUE)	140
Daikin <i>CIRRA</i>	60	DM92SN (Up to 92% AFUE)	141
Daikin RXMS series Multi-Zone Outdoor Units	62	<b>80% AFUE</b>	
Multi-Zone Indoor Units	66	DM80VC (Up to 80% AFUE)	142
Multi-Zone Combinations	78	DC80VC (Up to 80% AFUE)	143
<b>SkyAir Products</b>	<b>81</b>	DM80SC-U (Up to 80% AFUE)	144
FAQ_TAVJU - Wall-Mounted Unit	84	DM80TN (Up to 80% AFUE)	145
FBQ_TBVJU - DC Ducted Concealed	86	DC80TN (Up to 80% AFUE)	146
FCQ_AAVJU - <i>Round Flow</i> Cassette	88	DM80SN / DM80SN-U (Up to 80% AFUE)	147
FHQ_PVJU - Ceiling Suspended	90	DC80SN (Up to 80% AFUE)	148
FTQ_TAVJU - Multi-Position Air Handling Unit	92	<b>Air Handlers</b>	
<b>VRV LIFE</b>	<b>95</b>	DMVE (Multi-Position, Variable-Speed, Inverter-Tuned)	150
Solving HVAC Challenges	96	DFVE (Multi-Position, Variable-Speed, Inverter-Tuned)	151
<i>VRV LIFE</i> Outdoor Unit	98	DMVT (Multi-Position, Variable-Speed)	152
CXTQ <i>VRV A</i> -Coil	99	AMST (Multi-Position, Multi-Speed)	153
<b>Unitary Products</b>	<b>101</b>	MBVC (Modular Blower)	154
<b>Daikin One+ Smart Thermostat</b>	102	AWST (Multi-Position, Multi-Speed)	155
<b>Daikin One Touch Smart Thermostat</b>	104	AWSF (Multi-Position, Multi-Speed)	156
<b>Daikin One Premium Air Cleaner</b>	105	ACSF (Multi-Position, Multi-Speed)	157
<b>Daikin One Powered Ventilator</b>	106	<b>Coils</b>	
<b>Daikin One Home Air Monitor</b>	107	CAPEA / CAPE (1½–5 Tons)	158
<b>Daikin Fit System</b>	108	CAPT (1½–5 Tons)	159
Daikin <i>Fit</i> Air Conditioner and Heat Pump - DX6VS / DZ6VS	108	CAPTA (1½ - 3½ Tons)	160
Daikin D24V Gateway - Adaptor for <i>Fit</i> AC and 24V Furnace Systems	111	CAPFA (1½ - 3½ Tons)	161
Daikin <i>Fit</i> Air Handler - DFVE	113	CAPF (1½–5 Tons)	162
Daikin <i>Fit</i> Coils - CAPEA / CAPE / CHPE	114	CAUFA (1½–5 Tons)	163
		CAUF (1½–5 Tons)	164

SINGLE ZONE SYSTEMS

MULTI-ZONE SYSTEMS

SKYAIR PRODUCTS

VRV LIFE

UNITARY PRODUCTS

# Table of Contents (cont.)

























CHPE (Horizontal "A" Coil)	165
CHPF (Horizontal "A" Coil)	166
CHPTA / CHPT (1½–5 Tons)	167
CSCF (1½–5 Tons)	168
<b>Packaged Units</b>	
<b>Air Conditioners</b>	
DP3CH (13.4 SEER2)	170
<b>Heat Pumps</b>	
DP5HH (Up to 15.2 SEER2)	171
DP5HM (15.2 SEER2)	172
DP3HH (13.4 SEER2 & 6.7 HSPF2)	173
DP3HM (13.4 SEER2 & 6.7 HSPF2)	174

<b>Gas/Electric Units</b>	
DP5GM (Up to 15.2 SEER2 / 81% AFUE)	175
DP5UM Ultra-Low NOx (Up to 15.2 SEER2 / 81% AFUE)	176
DP3GM 13.4 SEER2 / 81% AFUE)	177
DP3UM Ultra-Low NOx (13.4 SEER2 / 81% AFUE)	178
<b>Duel-Fuel</b>	
DP3DM (13.4 SEER2, 6.7 SEER2, 81% AFUE)	179

## Outstanding Warranty Protection

The commitment and length of our limited warranties reflect the high standards of our manufacturing processes. That's why all Daikin brand products provide outstanding limited warranty protection. Why would you settle for anything less?

### COMFORTABLE LIMITED WARRANTY\* PROTECTION

Single and Multi-Zone Systems		SkyAir <sup>††</sup>	Packaged: Air Conditioner, Heat Pumps, Duel Fuel and Gas/Electric <sup>††</sup>				VRV LIFE	
17 series <sup>†</sup> , LV 30/36 <sup>†††</sup> , NV series <sup>†††</sup> , Daikin <i>CHIRA</i> <sup>†</sup>	Daikin <i>EMURA</i> <sup>†</sup> , Daikin 19 series <sup>†</sup> , Daikin <i>AURORA</i> <sup>†</sup> , LV series <sup>†</sup> , FDMQ <sup>†</sup> , Daikin <i>ATMOSPHERA</i> , MXS series <sup>†</sup> , Daikin <i>VISTA</i> <sup>†</sup> and RMXS <sup>†</sup>	All products	DP3CH, DP3HH, DP3HM	DP5HH, DP5HM	DP3GM, DP3UM	DP3DM, DP5GM, DP5UM	VRV LIFE	
				 	 	  	 	
Heat Pump and Air Conditioners <sup>††</sup>			Gas Furnace <sup>††</sup>			Air Handlers and Coils <sup>††</sup>		
DX9VC, DX7TC, DX6VS, DZ9VC, DZ6VS, DZ7TC, DZ4SE		DX3SQ, DZ4SQ, DX4SQ	DM96TN, DM97MC, DC97MC, DM96VC, DC96VC, DM80VC, DC80VC			DM96TN / DC96TN, DM96SN-U, DM96SN / DC96SN, DM92SN, DM80TN / DC80TN, DM80SN / DC80SN, DM80SN-U		DMVT, DMVE, DFVE, AWSF, AWST, ACSF, AMST, MBVC, CAPT, CAPTA, CAPFA, CAPF, CAUF, CAUFA, CHPF, CHPT / CHPTA, CAPEA / CAPE, CHPE, CSCF
 	 		  	  				

\* Complete warranty details available from your local dealer/contractor or at [www.daikincomfort.com](http://www.daikincomfort.com). To receive the 10-Year or 12-Year Parts Limited Warranties, the 10-Year Compressor Replacement Limited Warranty, the 20-Year Heat Exchanger Limited Warranty, the Lifetime Heat Exchanger Limited Warranty (good for as long as you own your home), and to receive the 2-Year, 6-Year, or 12-Year Unit Replacement Limited Warranty, online registration must be completed within 60 days of installation. Additional requirements for annual maintenance are required for the 2-Year, 6-Year, and 12-Year Unit Replacement Limited Warranties. Online registration and some of the additional requirements are not required in California or Québec.

<sup>†</sup> If product installed in a commercial application, limited warranty period is 5 years.

<sup>††</sup> If product installed in a commercial application, limited warranty periods will differ depending on the model.

<sup>†††</sup> Registration not required if installed in a commercial or residential application.



# Efficiency Standards – National and Regional

The newest U.S. Department of Energy (DOE) minimum efficiency changes go into effect on January 1, 2023, affecting all residential air conditioners and heat pumps we manufacture. The changes maintain regional standards that apply to Split System and Package Air Conditioners, with all metrics now based on the new metrics (SEER2/EER2/HSPF2). The DOE minimum efficiency standards include both national standards (which are based on date of manufacture) and regional standards (which are based on date of installation).

## National Standards

- » Split system heat pumps (14.3 SEER2 / 7.5 HSPF2)
- » Single package air conditioner (13.4 SEER2)
- » Single package heat pumps (13.4 SEER2 / 6.7 HSPF2)
- » Single package gas/electric (13.4 SEER2 / 81% AFUE)

## Regional Efficiency Standards

Only air conditioners (both split system and single package) are subject to regional efficiency standards. The map to the right summarizes the national and regional efficiency standards.

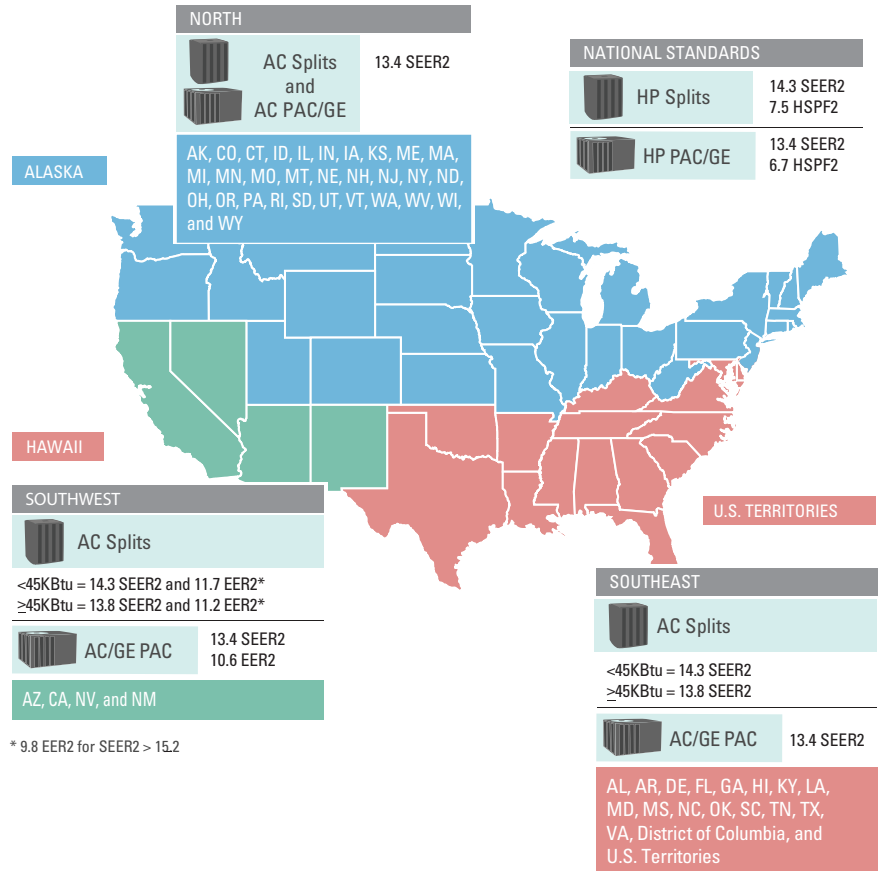

Efficiency Standards – National and Regional (continued on next page)

# Efficiency Standards – National and Regional (cont.)

## Labeling

There are two methods to help identify products subject to regional standards. The first is the EnergyGuide label that is noticeably different, with the inclusion of the map of the United States that identifies where the equipment can be installed.

The second is a separate statement that will be on the rating plate or on a label next to the rating plate called the “Install Prohibited” statement. All products subject to regional standards have both the EnergyGuide label and the Install Prohibited statement.

NOTE: The Federal Trade Commission (FTC) originally required a range of SEER be placed on Split System products subject to regional efficiency standards. However, they reversed their decision and now only a single value is listed (since mid-2017). Products in inventory may have mixed EnergyGuide labels (some having a range, others having a single value for SEER). FTC does not require re-labeling of existing product.

## EnergyGuide Labels Currently In Effect

**EnergyGuide Labels with SEER**

**EnergyGuide Labels with SEER2**

**EnergyGuide Labels with SEER and Map**

**EnergyGuide Labels with SEER2 and Map**

Number SEER ≥ 15 (for 1.5 to 3.5 ton\*) SEER ≥ 14.5 (for 4 to 5 ton\*\*) can be installed in SouthEast

With map – subject to Regional Standards

No map – can be installed nationally

Can be installed in SouthWest  
 EER > 12.2 if 1.5 to 3.5 ton\*  
 > 11.7 if 4 or 5 ton\*\*  
 > 10.2 if SEER ≥ 16

## What You Need to Know as a Distributor

DOE defines a distributor as “a person (other than a manufacturer or retailer) to whom a consumer product is delivered or sold for purposes of distribution in commerce.” Therefore, if you resell product for sale other than to an end user, you may be considered a distributor as opposed to a contractor or dealer (see definitions below).

Distributors are required to comply with the requirements:

1. Do not knowingly sell product that will be installed in violation of regional standards.
2. Conduct regional standards training for all employees and customers.
3. Maintain records for all units subject to the regional standards for a period of 54 months. These records are to include the outdoor unit manufacturer, model number, serial number, date of purchase, date of sale, customer name and delivery address if delivered.

## What You Need to Know as a Contractor/Dealer

As a contractor or dealer, you will also be required to adhere to requirements of the DOE HVAC Regional Standards Enforcement Rules. DOE has defined a contractor as “a person (other than the manufacturer or distributor) who sells to and/or installs for an end user a central air conditioner subject to regional standards.” DOE has defined a dealer as “a type of contractor, generally with a relationship with one or more specified manufacturers.”

The contractor/dealer requirements include the following:

1. Do not knowingly install product that is in violation of regional standards.
2. Conduct regional standards training for all employees.
3. Maintain records for all units subject to the regional standards for a period of 48 months. These records to include the indoor and outdoor unit manufacturer and model number, outdoor unit serial number, distributor purchased from, date and address of installation.

Also important is that DOE defines “installation of a central air conditioner” as “the connection of the refrigerant lines and/or electrical systems to make the central air conditioner operational.”

## Enforcement

Enforcement of the standards will be at least partially via complaints registered with the DOE. DOE has set up an email for reporting suspected violations directly to them at [EnergyEfficiencyEnforcement@doe.gov](mailto:EnergyEfficiencyEnforcement@doe.gov), or suspected violations can be reported by phone, at (202) 287-6997.

All verified violations will require remediation and can result in stiff fines. Notices of Violation will be posted publicly by the DOE. Further, if a distributor or contractor/dealer is found to routinely violate the standards, manufacturers can be prohibited from selling products to that party.

Contractors, dealers and distributors should be aware that the DOE may request copies of documentation proving product sales and installations are in compliance. Records requested by DOE must be provided within 30 days.

## Questions

Questions about the efficiency standards can be emailed to [RegionalStandardsQuestions@daikincomfort.com](mailto:RegionalStandardsQuestions@daikincomfort.com).

### IMPORTANT NOTE:

The information provided is a summarized overview and is not intended to provide a complete description of the DOE Regional Standards. For more information regarding the DOE Regional Standards and the enforcement of these standards, please visit: [www.energy.gov/gc/legal-resources/office-assistant-general-counsel-enforcement/regional-standards-enforcement](http://www.energy.gov/gc/legal-resources/office-assistant-general-counsel-enforcement/regional-standards-enforcement)

# Why Zoned Systems?

## DAIKIN HAS A FOCUS AND TRACK RECORD OF QUALITY

With almost 100 years of HVAC history since its founding, Daikin has created a global indoor comfort revolution with innovative new technologies and products that have brought firsts to the world. From the introduction of new compressor designs or new ways to precisely control refrigerant flow, Daikin strives to be a global leader by investing in technology. We bring this same focus on innovation to North America, applying our portfolio of product features from around the world to meet the unique or specialized applications we face in North America homes and businesses.

### Optimal design and comfort for the or the whole home & light commercial applications

#### Integrated design

Daikin indoor single and multi-zone units offer homeowners a discreet, modern design. The unit's smooth curve blends beautifully with the wall resulting in an unobtrusive presence that matches virtually all interior décors.

#### Efficient and smart

Inside the single and multi-zone system is a highly intelligent system, with innovative features designed to reduce power consumption. Some units offer whisper-quiet performance down to 19\* db(A) to further to your sense of comfort.

#### Intelligent eye

The intelligent eye occupancy sensor, available on select models, controls comfort and conserves energy. If the room is empty for 20 minutes it changes the set point to start saving energy. As soon as someone enters the room, it immediately returns to the original setting. Regular use of this feature can provide additional energy savings of up to 20% or more compared to units without this feature.

#### Daikin single and multi-zone systems offer dealers:

- » High-quality, energy-efficient comfort solutions
- » Opportunities to spend less time on installations and more time with new customers
- » Differentiated product offerings that deliver improved customer satisfaction
- » Outstanding limited warranties\*\* and reduced call backs

\*On SL fan speed in cooling mode

#### \*Asure<sup>SM</sup>

Adds value to homeowner's purchase. Provides the homeowner peace-of-mind that they have protected their investment and guaranteed their comfort system for the terms of their agreement against unplanned repair bills.

\*See inside back cover for more information.



As an innovation leader, Daikin is laying the foundation for next generation technology with multiple cutting-edge core technologies. Forbes Magazine recognized Daikin as an innovation leader, putting Daikin on its list of the 100 Most Innovative companies in the world.



Source: [www.forbes.com](http://www.forbes.com)

\*\* Complete warranty details available from your local distributor or manufacturer's representative or at [www.daikincomfort.com](http://www.daikincomfort.com)



## A full range of styles and options for every home, and every room

Daikin single and multi-zone systems are an ideal solution to displace traditional systems in primary living spaces or for refurbishing and remodeling additional spaces. They have a modern design and are extremely quiet in operation.

Our heat pumps are all-in-one heating and cooling solutions, meaning comfortably warm in winter and cool in summer.

### Smart Inverter Technology

Daikin's inverter technology is a true innovation in the field of climate control. The principle is simple: inverters adjust the power used to suit the actual requirement – no more, no less! Single & multi-zone systems deliver the capacity required to maintain desired room conditions, typically reducing energy consumption by up to 30% or more compared to traditional fixed-speed ducted systems. This technology minimizes temperature fluctuations and provides continuous cooling and heating comfort.

### Whisper Quiet

Daikin systems feature low indoor and outdoor operating sound pressure levels - indoor sound pressure levels as low as 19\* decibels (dB(A)) and outdoor sound pressure levels as low as 43\* dB(A).

\*On SL fan speed in cooling mode.

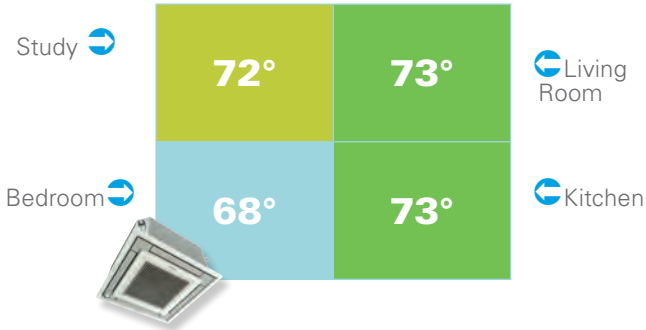
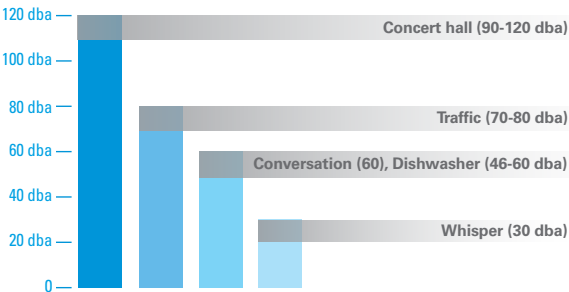

### Advanced Filtration

Long life, washable filters.

### Heating Performance

Daikin systems provide heating performance with single and multi-zone Heating Seasonal Performance Factor's (HSPF's) as high as 13.8, making Daikin systems efficient and effective even in extreme environments.

# R-32 REFRIGERANT

## THE NEXT GENERATION OF DAIKIN HVAC SYSTEMS USING R-32 REFRIGERANT

R-32 Refrigerant: Proven. Easy. Efficient. Available. The Right Choice to Replace R-410A.

**R32** Daikin is leading the industry with the switch to the next generation of refrigerants that have a lower Global Warming Potential (GWP) than R-410A: R-32.

R-32 is the A2L refrigerant that's widely used around the world today, making R-32 the easy choice and the proven global standard.

In addition, R-32 is the only pure, single-component refrigerant slated to replace the high GWP refrigerant, R-410A. Unlike blended refrigerants, which can change composition, R-32 is easy to top off or clean and reuse on-site. It's also easy to reclaim and reuse off-site with a simple cleaning process.

Perhaps most importantly, R-32's excellent thermodynamic properties allow systems to be up to 12% more efficient than R-410A. Additionally, because R-32 has a GWP of 675 and requires less charge in certain systems, direct emissions from those systems can be up to 80% lower than similar R-410A systems. The result? Fewer greenhouse gas emissions that contribute to climate change, based on Daikin studies.

### R-32 is focused on four main elements:

Proven	Efficient	Easy	Available
» Globally accepted	» Excellent thermodynamic properties » Reduced indirect emissions vs. R-410A » Can consume less electricity over the lifetime of the equipment vs. R-410A	» Pure, single-component refrigerant » Easy to top off, or clean and reuse on-site » Easy to reclaim and recycle	» Adopted in over 90 countries » A component in R-410A » Non-proprietary

### Single and Multi-Zone Systems

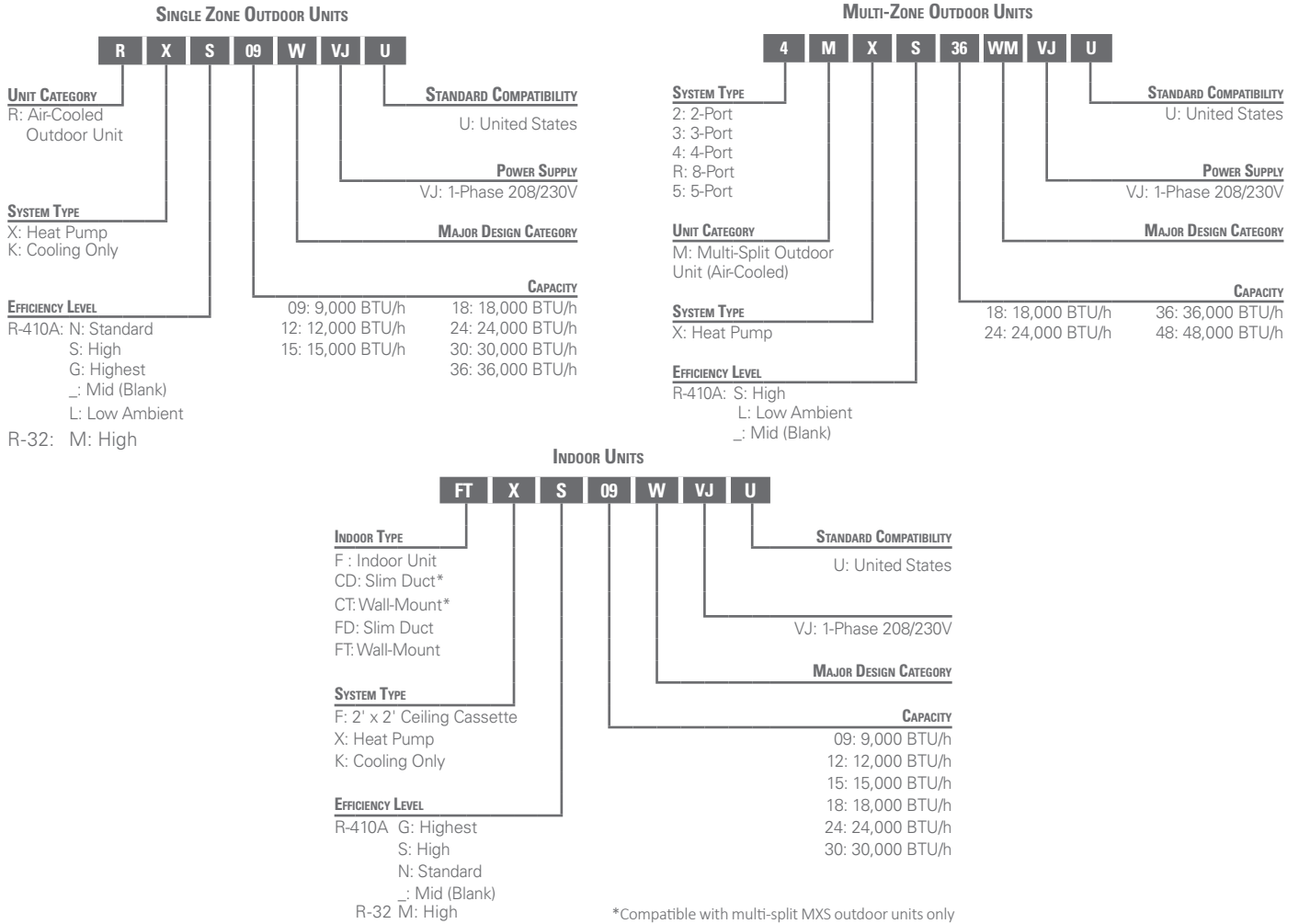

### Single-Zone Systems

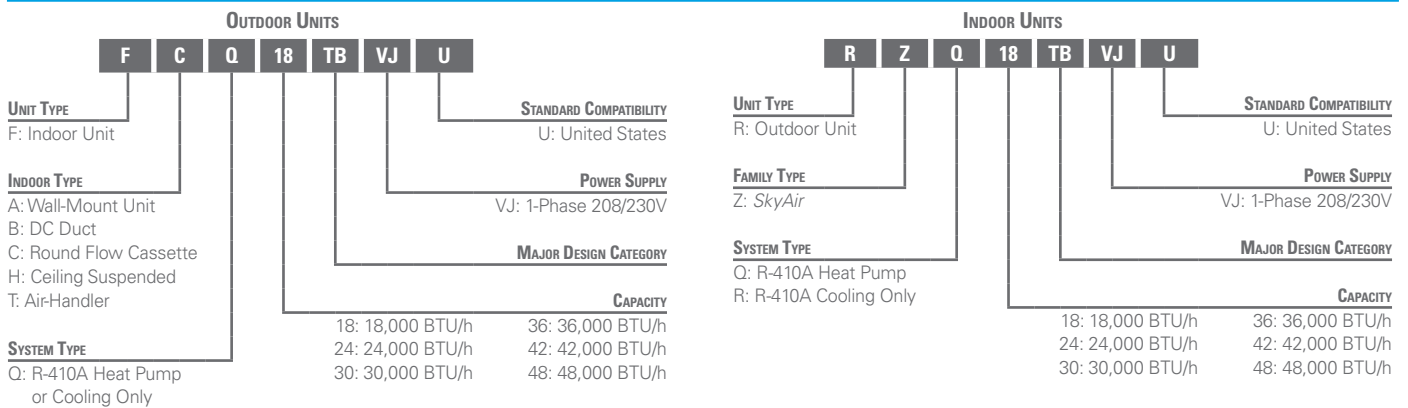

# Key Features and Benefits

## Superior Comfort Control

### Indoor Unit Quiet Operation.



Sound levels are reduced by 2-3 decibels (dB) from the low fan speed for quieter and gentler heating and cooling.

### Outdoor Unit Quiet Operation.



Outdoor unit sound levels can be reduced by 3dB for times when quieter operation is needed.

### Intelligent Eye.



The intelligent eye is an infrared sensor with the ability to sense movement in the room. When you are in the room, the air conditioner operates normally. If you leave the room for more than 20 minutes the air conditioner automatically changes to an energy-saving operation. Using the intelligent eye, savings of up to 20% in cooling and up to 30% in heating can be achieved compared to units without this feature.

### Automatic Operation.



For unattended year-round comfort, this function allows the unit to automatically switch between heating and cooling modes as required. (heat pumps types only)

### Program Dry Function.



This gives priority to reducing the level of humidity in the room rather than room temperature.

### Auto Fan Speed.



To reduce operating sound and power consumption, the fan speed is automatically controlled by the micro-processor to suit the controller setting and prevailing room temperature.

### Hot Start.



When the heating operation starts or when the unit changes from cooling to heating there is no cold draft released into the room.

### Hybrid Cooling.



Dehumidifies efficiently even in low cooling loads, and maintains dehumidification effect after the target temperature is reached.

## Cold Climate

### Daikin AURORA Models.



These systems have been designed to deliver effective heating performance to ambient conditions as low as -13°F WB (-25°C WB).

### Low Ambient Cooling.



System is able to operate in cooling mode below 0°F DB (-17.7°C DB) outside temperature with field settings and/or optional accessories.

## Lifestyle

### Econo Mode.



Limits the maximum operating current and power consumption of the outdoor unit by approximately 30% during start-up. This saves energy and reduces the load on the electrical circuit when multiple electrical devices are used simultaneously.

### Powerful Operation.



Pushing the POWERFUL button on the remote control gives you a boost in cooling or heating power for a 20-minute period, even if the unit is already operating at high capacity.

### Remote Controller with Back-lit Display.



Features a back-lit LCD and luminescent control buttons, allowing for easy viewing in dimly lit rooms.

### Indoor Unit On/Off Switch.



A convenient on/off switch on the indoor unit allows you to start up the system even if you have misplaced the remote control or the remote control batteries are exhausted.

### Simplified Maintenance.



The indoor unit has been re-designed for easier removal of the drain pan, blower wheel, and indoor fan motor (compared to other wall-mounted units).

## Comfortable Airflow

### Wide Angle Louvers.



Smoothly curved wide-angle louvers provide wide airflow coverage for effective heating and cooling no matter where the indoor unit is placed within the room.

### Draft Reduction.



This system directs warm air to the floor in winter and cool air across the room in summer for optimal efficiency and comfort. The large flap governs airflow direction while the small flap (or diffuser) swings, producing fine air currents that help circulate the air around the room.

### Comfort Mode.



Comfort Mode operation improves comfort. When cooling, the flap positions itself horizontally to keep cold airflow from being blown directly onto the body. When heating, the flap turns vertically downwards to drive warm air to the bottom of the room.



## ECO+



An intelligent feature that ensures optimum energy consumption while fulfilling basic human comfort needs. Once activated, set temperature will be adjusted automatically to an optimum energy consumption level.

## Vertical Auto-Swing (up and down).



The vertical auto swing automatically sweeps the air across the room in an up and down motion. When the unit is switched off, the louvers close automatically.

## Horizontal Auto-Swing (left and right).



Automatically moves to ensure an even distribution of air throughout a room.

## 3-D Airflow.



Combines vertical and horizontal auto-swing to circulate cool/warm air to the corners of large spaces.

## Worry Free

### Auto-Restart.



The unit memorizes the operation mode, airflow and temperature settings. Should there be a power failure when the unit is in operation, it will automatically return to the same operating conditions when the power is restored.

### Self-Diagnosis.



In the event that a problem develops with the unit, malfunction codes can be displayed on the liquid crystal panel of the remote control for fast and easy fault diagnosis.

### Anti-Corrosion.



The special anti-corrosion coating on the outdoor unit heat exchanger provides resistance to salt damage and atmospheric corrosion.

### Blue Fin Protection.



The hydrophilic coated fin ensures the condensate water moves easily to the drain pan — thus enhancing the cleanliness and lifespan of the cooling coil.

## Comfortable and Clean

### Titanium Apatite Photocatalytic Air-Purifying Filter.



This filter combines the air-purifying filter and titanium apatite photocatalytic deodorizing filter in a single highly effective unit. The filter can last for up to three years without replacement if washed once every six months.

## CLEAN Operation.



The CLEAN function dries the interior of the indoor unit to reduce the amount of condensation present. When COOL or DRY operation is performed, condensation may occur inside the air conditioner. It is recommended to dry the inside of the air conditioner using CLEAN operation.

## Wipe-Clean Flat Panel.



The flat panel models can be cleaned with only the single pass of a cloth across their smooth surface. The flat panel can also be easily removed for more thorough cleaning.

## Timers

### 24-Hour On/Off Timer.



The timer can be preset to start and stop the air conditioner at any time within a 24-hour period. Once the times are set, the air conditioner can be operated for a period by simply pressing the ON or OFF timer buttons.

### Weekly Timer.



The weekly timer function makes it easy to enter up to four settings per day for each day of the week. The weekly timer function not only allows you to program on and off time, but also the desired temperature.

### Night Set Mode.



Through the use of the 'Timer-OFF Circuit', the preset room temperature gently rises in cooling or falls in heating before the unit stops. This energy-saving feature allows you to sleep comfortably without feeling a sudden change in the room temperature, while at the same time saving energy.

## Keeping Warm

### Quick Warming Function.



Prevents the compressor from pumping liquid refrigerant in low-ambient conditions. (Heat pumps only)

### Automatic Defrosting.



Sensor performs automatic defrosting of the outdoor heat exchanger if necessary, ensuring optimum heating performance. (Heat pumps only)

### Intelligent Defrost Mode



The outdoor unit will enable this mode to help prevent frost/ice from building up in cold climate conditions. It will also help with longer heating operation time for additional comfort for occupants (compared to HVAC systems without this function).

# Single and Multi-Zone System Overview

		7K Btu/h	9K Btu/h	12K Btu/h	15K Btu/h	18K Btu/h	24K Btu/h	30K Btu/h	36K Btu/h	48K Btu/h	Warranty*
SINGLE ZONE	17 SERIES	HP									
		AC									
	19 SERIES	HP									
		AC									
	DAIKIN EMURA	HP									
	DAIKIN AURORA	HP									
	LV SERIES	HP									
		AC									
	FDMQ	HP									
	NV SERIES	HP									
AC											
DAIKIN ATMOSPHERA	HP										
DAIKIN VISTA	HP										
MULTI-ZONE	DAIKIN AURORA (MULTI-ZONE)	HP									
	MXS SERIES	HP									
	RMXS_LVJU	HP									
	DAIKIN CIRRA	HP									

\* Complete warranty details available from your local dealer/contractor or at [www.daikincomfort.com](http://www.daikincomfort.com). To receive the 10-Year or 12-Year Parts Limited Warranty, online registration must be completed within 60 days of installation. Online registration is not required in California or Québec.

If product installed in a commercial application, limited warranty period is 5 years.

# Zoned System Features

Model Family Model Series Indoor Type		FTKB_AX • 17 Series Cooling Only	FTK_AX • 19 Series Cooling Only	FTXB_AX • 17 Series HP	FTX_AX • 19 Series HP	FTX_NM AURORA • Wall-Mount	FDXS_LV LV Series Low-Static Concealed Wall-Mount	FTXS_LV LV Series Wall-Mount	FTXG_H	FTXM_V** • ATMOSPHERA	FVXS_N • Floor Mount	CDXS_LV • Multi-Zone Concealed	FDMQ_R Concealed Ducted	CTXS_LV • Multi-Zone Wall-Mount	FTXR_T • Emura	FFQ_Q • Vista Cassette	FTX_U • NV Series Wall-Mount	CTX_A CIRBA Multi Wall-Mount	
Comfortable Airflow	Draft Reduction							■	■	■				■	■		■		
	Wide Angle Louvers	■	■	■	■	■		■	■	■	■			■	■		■	■	
	Vertical Auto Swing (up and down)	■	■	■	■	■		■	■	■	■			■	■		■	■	
	Horizontal Auto Swing (left and right)							■	■	■				■	■		■	■	
Superior Comfort Control	3-D Airflow							■	■	■				■	■		■		
	Comfort Mode					■		■	■	■				■	■		■		
	Indoor Unit Quiet Operation	■	■	■	■	■	■	■	■	■	■	■		■	■		■	■	
	Outdoor Unit Quiet Operation						■	■		■	■	■		■	■		■	■	
	Intelligent Eye							■	■	■				■	■		■	■	
	Automatic Operation			■	■	■	■	■	■	■	■	■	■	■	■	■	■	■	■
	Program Dry Function	■	■	■	■	■	■	■				■	■	■	■	■	■	■	■
	Hybrid Cooling									■									
	Auto Fan Speed	■	■	■	■	■	■	■	■	■	■	■	■	■ <sup>1</sup>	■	■	■	■	■
	Hot Start				■	■	■	■	■	■	■	■	■	■	■	■	■	■	■
Comfortable and Clean	Titanium Apatite Photocatalytic Air Purifying Filter	■	■	■	■	■		■	■	■	■			■	■		■	■	
	Wipe Clean Flat Panel	■	■	■	■	■		■	■	■	■			■	■		■	■	
	CLEAN operation									■									
Lifestyle	ECO+	■	■	■	■													■	
	Econo Mode					■	■	■		■	■	■		■	■		■	■	
	Simplified Maintenance				■														
	Powerful Operation	■	■	■	■	■	■	■	■	■	■	■		■	■		■	■	
	Remote Controller with Back-lit Display	■	■	■	■	■	■	■		■	■	■	■ <sup>1</sup>	■	■	■ <sup>1</sup>	■	■	
	LCD Wireless Remote Control	■	■	■	■	■	■	■	■	■	■	■		■	■		■	■	
Timers	Built-In Wi-Fi									■								■	
	Wi-Fi with additional adaptor		■		■	■	■	■	■		■	■	■	■	■	■	■	■	
	24 Hour On/Off Timer	■	■	■	■		■	■	■	■	■	■	■ <sup>1</sup>	■	■		■	■	
	Weekly Timer							■		■	■			■	■		■	■	
Worry Free	Night Set Mode	■	■	■	■	■	■	■	■	■	■	■		■	■		■	■	
	All Daikin Systems: Auto Restart, Blue Fin Protection, Self Diagnosis, Anti-Corrosion, Smart Inverter, Designed for North America <sup>1</sup>	■	■	■	■	■	■	■	■	■	■	■	■	■	■	■	■	■	■
Cold Climate	Daikin AURORA Models					■	■	■			■	■	■	■	■	■	■		
	Low Ambient Cooling*		■		■	■	■	■	■	■	■	■	■	■	■	■	■	■	

<sup>1</sup> With wired remote controller \*May require field settings and/or optional accessories. See engineering manual for specific information.

■ When connected to Daikin AURORA Multi-Zone System

\*\*Not available in all markets. Check with local distributor

# Control from Anywhere

## Innovative Control Solutions



### Navigation Remote Controller (Wired) (BRC1E73)

The *Navigation* Remote Controller offers scalable control architecture optimized for Daikin FFQ, FDMQ single zone, multi-zone and *SkyAir* systems. The wall-mounted controller features a back-lit LCD display as well as intuitive menus. The menu displays are available in English, French, or Spanish languages.



### Hand-held Wireless Controller

Hand-held controllers, included with most indoor units, provide flexible control of Daikin single and multi-zone systems including: temperature control, operating modes, weekly programming, and more.



### Easy-to-use

User-friendly interface makes it easy to set up a personalized program, adjust settings, and make adjustments anytime, anywhere.



### Nature

Save money on utility bills and reduce energy consumption (as compared to non-scheduled systems) with the weekly schedule.

## DKN App for Wi-Fi control of your Single & Multi-Zone System\*



It can happen to anyone. You forgot to change the temperature of your heat pump system or air conditioner before leaving the house or you will be delayed returning home and wish to avoid needlessly heating or cooling your home. What in the past would have resulted in wasted energy is no

longer a problem? With the DKN App, you are always in control. You can use your tablet or smartphone to access your Daikin system via the internet. Fault conditions can also be detected remotely, allowing a quick response to problems.



\* Requires AZAI6WSCDKA or AZAI6WSC DKB Wi-Fi adaptors or AZAI6WSPDKC DKN Plus Interface depending on the indoor unit



### Functions accessible via the DKN App



**Auto Mode** – Your Daikin system will change between cooling or heating to maintain the desired temperature range.



**Fan Mode** – The indoor unit fan will run to circulate the air in the space without cooling or heating



**Heating Mode** – Your Daikin system will only run in heating mode to maintain the desired heating temperature



**Cooling Mode** – Your Daikin system will only run in cooling mode to maintain the desired cooling temperature



**Dry Mode** – Your Daikin system will continually work to dry the air without affecting the temperature in the space



**Schedule** – Adjust or set a schedule remotely





### Daikin One+ Smart Thermostat



The Daikin *One+* Smart Thermostat is now available for select single and multi-zone indoor unit models. With the new translation adaptor, connecting the Daikin *One+* Smart Thermostat provides several user features including remote monitoring, control and geofencing using the Daikin *One* home app, *Google*, and *Amazon* voice assistants. Learn more at [www.daikinone.com](http://www.daikinone.com).

\*\* Note that the a handheld remote should not be used together with the Daikin *One+* Smart Thermostat.

### Daikin Madoka Remote Controller



Daikin is pleased to introduce the *Madoka* remote controller for the North American FDMQ, FFQ & *SkyAir* indoor units. The *Madoka* features a sleek and stylish design with an intuitive interface including touch button control. It retains advanced functions for indoor unit control. It can be commissioned and managed with ease through a Bluetooth® configuration app or via the onboard menus. The *Madoka* provides 3 configurable display modes: Text (default), Icon, and Scale to help meet project and occupant needs. Learn more at [www.daikinac.com](http://www.daikinac.com).

**Award-winning design.**  
*Madoka* earned an IF design award and Red Dot Product Design Award for its innovative design.

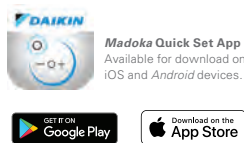

**Coming Soon!**

### Daikin Adaptive Touch Controller



The Daikin *Adaptive Touch Controller* (ATC) is used to control FDMQ & FFQ indoor units with advanced and configurable control logic. The *ATC* comes in 4 different models with a built-in temperature sensor, humidity sensor, CO<sub>2</sub> sensor, and occupancy sensor.

The *ATC* will also provide analog input, analog output, digital input, and digital output terminals to monitor auxiliary sensors and control auxiliary equipment. The built-in sensors can be combined with advanced logic to create actionable tasks based upon the sensor values. The *ATC* controller can be integrated with a compatible building management system (BMS) using BACnet™ MS/TP.

### Daikin DKN Plus Interface



The new Daikin DKN Plus Interface (AZAI6WSPDKC) enables the energy-efficient control of Daikin air conditioners by a third-party thermostat or an automation system. With this interface, third party devices or systems can control the *SkyAir* indoor units through the DKN Cloud NA App via Wi-Fi, Cloud API, Modbus®, BACnet™ MS/TP, or thermostat relay contacts. This interface can be commissioned easily through the DKN Cloud NA app via Bluetooth® Low Energy (BLE). Learn more at [www.daikinac.com](http://www.daikinac.com)

### Daikin SplitXpress Selection Tool

The new interactive *SplitXpress* mobile app and website provide a complete product selection tool to streamline system selection for single and multi-zone projects. Users can create equipment selections and add accessories / pricing details to quickly share quotes with customers. Available for free on the *App Store* (iOS) and *Google Play* (Android), and at <https://splitxpress.daikincity.com>.





# Single Zone Systems





## Daikin 17 series

# Wall-Mounted Cooling Only & Heat Pump 17 SEER | 9 HSPF

## COMFORTABLE LIMITED WARRANTY\* PROTECTION



\* Complete warranty details available from your local dealer/contractor or at [www.daikincomfort.com](http://www.daikincomfort.com). To receive the 10-Year Parts Limited Warranty, online registration must be completed within 60 days of installation. Online registration is not required in California or Québec. The duration of warranty coverages in Texas differs in some cases.  
*If product installed in a commercial application, limited warranty period is 5 years.*

Daikin 17 series is available in both cooling only and heat pump configurations to offer a stylish design at an outstanding value. Wall-mounted units are simple to install and can be placed subtly, high on a wall, where they do not detract from your décor and operate very quietly.

### Standard Features

- » Energy Efficient – 17 SEER, 9 HSPF, up to 11 EER – Variable-Speed, Inverter, Compressor
- » Cooling Range: 50° - 115°F
- » Heating Range: 5° - 65°F
- » Indoor Sound Pressure as low as 22 dB(A)
- » Outdoor Sound Pressure as low as 46 dB(A)
- » ECO+
- » Titanium Apatite Photocatalytic Air Purifying Filter
- » Powerful Operation Mode
- » Wireless Remote Controller
- » Auto Changeover (Heat Pump Only)
- » Auto Fan Speed Control
- » Self-Diagnostics with Digital Display
- » Auto-Restart after Power Failure
- » Anti-Corrosion Heat Exchanger Treatment
- » Quick warming function (Heat Pump)
- » Automatic defrosting (Heat Pump)

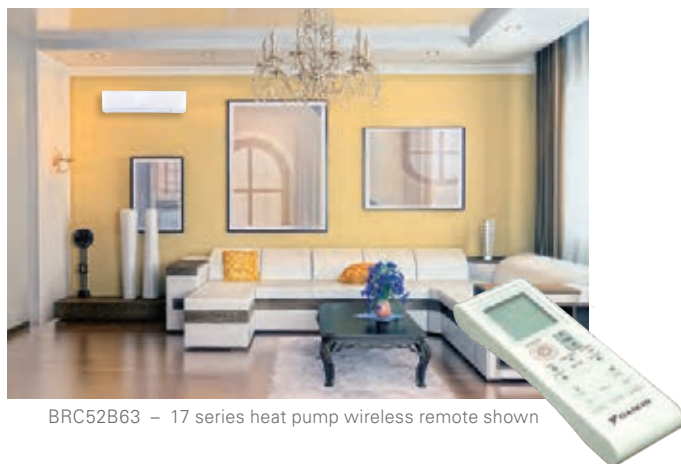

BRC52B63 – 17 series heat pump wireless remote shown

### IDEAL SOLUTIONS FOR:

- › Renovations, remodeling and new construction
- › Sun rooms, basements, attics, garages, hot or cold rooms, and more
- › Rooms where floor space comes at a premium or is not available for other application
- › Ceiling void or attic does not allow for a viable duct run option
- › Cooling Only models are an excellent value for space not requiring heating



**ECO+** – An intelligent feature that ensures optimum energy consumption while fulfilling basic human comfort needs. Once activated, set temperature will be adjusted automatically to an optimum energy consumption level



**Auto-Restart** – The unit memorizes the operation mode, airflow and temperature settings. Should there be a power failure when the unit is in operation, it will automatically return to the same operating conditions when the power is restored.



**Titanium Apatite Photocatalytic Air Purifying Filter** – This filter combines the air-purifying filter and titanium apatite photocatalytic deodorizing filter in a single highly effective unit.



**Blue Fin Protection** – The hydrophilic coated fin ensures the condensate water moves easily to the drain pan — thus enhancing the cleanliness and lifespan of the cooling coil.



**Powerful Operation Mode** – Pushing the POWERFUL button on the remote control gives you a boost in cooling or heating power for a 20-minute period, even if the unit is already operating at high capacity.



# Daikin 17 series

## Wall-Mounted Cooling Only

17 SEER | Up to 11 EER



SINGLE ZONE SYSTEMS

Model	Indoor Unit		FTKB09AXVJU	FTKB12AXVJU	FTKB18AXVJU	FTKB24AXVJU
	Outdoor Unit		RKB09AXVJU	RKB12AXVJU	RKB18AXVJU	RKB24AXVJU
Capacity Rated (Min. ~ Max.)	Btu/h		8,800	11,000	18,000	21,200
Moisture Removal	gal/h		4,400 - 10,200	4,400 - 13,000	4,300 - 21,200	6,000 - 22,200
EER Rated			11	8.5	10.5	11
SEER			17	17	17	17
Piping Connections	Liquid	in. (mm)	Ø 1/4 (Ø 6.4)			
	Gas		Ø 3/8 (Ø 9.5)		Ø 1/2 (Ø 12.7)	
	Drain		Ø 3/4 (Ø 19.0)			
Max. Interunit Piping Length			65-5/8 (20)		98-1/2 (30)	
Max. Interunit Height Difference			32-13/16 (10)			
Chargeless			25 (7.6)			
Amount of Additional Charge of Refrigerant	oz/ft (g/m)		0.21 (20)			
Operating Range - Cooling	°F DB		50° - 115°F			
Indoor Unit			FTKB09AXVJU	FTKB12AXVJU	FTKB18AXVJU	FTKB24AXVJU
Airflow Rate	H	cfm (m³/min)	330 (9.3)	360 (10.2)	430 (12.2)	555 (15.7)
	M		272 (7.7)	282 (8.0)	374 (10.6)	486 (13.8)
	L		215 (6.1)	232 (6.6)	318 (9.0)	405 (11.5)
	SL		165 (4.7)	165 (4.7)	274 (7.8)	336 (9.5)
Fan	Speed	Steps	5 Steps, Quiet, Auto			
Air Direction Control			Horizontal, Downward			
Air Filter			Titanium Apatite			
Dimensions (H x W x D)	in. (mm)		11-11/16 x 35-1/16 x 8-1/4 (297 x 891 x 210)		12-5/8 x 46-1/8 x 9-1/2 (321 x 1172 x 241)	
Weight	lbs. (kg)		20 (9.1)		31 (14)	
Sound Pressure Level (H / M / L / SL)	dB(A)		42 / 35 / 30 / 23	42 / 35 / 32 / 22	40 / 37 / 35 / 32	47 / 44 / 41 / 37
Outdoor Unit			RKB09AXVJU	RKB12AXVJU	RKB18AXVJU	RKB24AXVJU
Compressor	Motor Output	W	-			
Refrigerant	Type		R-410A			
	Charge	lbs. (kg)	1-5/8 (.74)	2-1/5 (1)	2-3/4 (1.3)	3-1/5 (1.5)
Airflow Rate	H	cfm (m³/min)	900 (25.5)	730 (20.7)	1690 (47.9)	1796 (50.9)
	SL		-			
Dimensions (H x W x D)	in. (mm)		21-5/8 x 25-15/16 x 10-3/4 (549 x 659 x 273)		25-11/16 x 33-11/16 x 12-15/16 (652 x 856 x 329)	
Weight	lbs. (kg)		53 (24)	57 (26)	82 (37)	97 (44)
Sound Pressure Level	H	dB(A)	46	48	53	52

Unit Combination		Power Supply				Compressor	OFM		IFM	
INDOOR UNIT	OUTDOOR UNIT	Hz - VOLTS	VOLTAGE RANGE	MCA	MOCP	RLA	W	FLA	W	FLA
FTKB09AXVJU	RKB09AXVJU	60 - 208	Min. 187 V Max. 253 V	6.95	15	6.75	41	0.19	18	0.20
		60 - 230								
FTKB12AXVJU	RKB12AXVJU	60 - 208	Min. 187 V Max. 253 V	7.7	15	7.5	41	0.19	18	0.20
		60 - 230								
FTKB18AXVJU	RKB18AXVJU	60 - 208	Min. 187 V Max. 253 V	13.2	20	13	61	0.5	40	0.24
		60 - 230								
FTKB24AXVJU	RKB24AXVJU	60 - 208	Min. 187 V Max. 253 V	13.2	20	13	61	0.5	40	0.24
		60 - 230								

# Daikin 17 series

## Wall-Mounted Heat Pump

17 SEER | 9 HSPF



Model	Indoor Unit		FTXB09AXVJU		FTXB12AXVJU		FTXB18AXVJU		FTXB24AXVJU	
	Outdoor Unit		RXB09AXVJU		RXB12AXVJU		RXB18AXVJU		RXB24AXVJU	
			Cooling	Heating	Cooling	Heating	Cooling	Heating	Cooling	Heating
Capacity Rated		Btu/h	8,800	9,400	11,000	11,300	18,000	17,900	21,200	21,200
(Min. - Max.)			4,400 - 10,200	4,400 - 13,600	4,400 - 13,000	4,400 - 16,200	4,300 - 21,200	4,000 - 22,500	6,000 - 22,200	4,100 - 27,300
Moisture Removal		gal/h	—	—	—	—	—	—	—	—
COP Rated			3.6		3.3		3.7		3.7	
EER Rated			11		8.5		10.5		11	
SEER			17							
HSPF			9							
Piping Connections		Liquid	Ø 1/4 (Ø 6.4)							
		Gas	Ø 3/8 (Ø 9.5)		Ø 1/2 (Ø 12.7)		Ø 5/8 (Ø 15.9)			
		Drain	Ø 3/4 (Ø 19.0)							
Max. Interunit Piping Length			65-5/8 (20)				98-1/2 (30)			
Max. Interunit Height Difference		ft. (m)	32-13/16 (10)							
Chargeless			25 (7.6)							
Amount of Additional Charge of Refrigerant		oz/ft. (g/m)	0.21 (20)							
Operating Range - Cooling		°F DB	50° - 115°F							
Operating Range - Heating*		°F WB	5° - 65°F							
Indoor Unit			FTXB09AXVJU		FTXB12AXVJU		FTXB18AXVJU		FTXB24AXVJU	
Airflow Rate	H	cfm (m³/min)	330 (9.3)		360 (10.2)		430 (12.2)		555 (15.7)	
	M		272 (7.7)		282 (8.0)		374 (10.6)		486 (13.8)	
	L		215 (6.1)		232 (6.6)		318 (9.0)		405 (11.5)	
	SL		165 (4.7)		165 (4.7)		274 (7.8)		336 (9.5)	
Fan	Speed	Steps	5 Steps, Quiet, Auto							
Air Direction Control			Horizontal, Downward							
Air Filter			Titanium Apatite							
Dimensions (H x W x D)		in. (mm)	11-11/16 x 35-1/16 x 8-1/4 (297 x 891 x 210)				12-5/8 x 46-1/8 x 9-1/2 (321 x 1172 x 241)			
Weight		lbs. (kg)	20 (9.1)				31 (14)			
Sound Pressure Level (H / M / L / SL)		dB(A)	42 / 35 / 30 / 23		42 / 35 / 32 / 22		40 / 37 / 35 / 32		47 / 44 / 41 / 37	
Outdoor Unit			RXB09AXVJU		RXB12AXVJU		RXB18AXVJU		RXB24AXVJU	
Compressor	Motor Output	W	—							
Refrigerant	Type		R-410A							
	Charge	lbs. (kg)	1-5/8 (.74)		2-1/5 (1)		2-3/4 (1.3)		3-1/5 (1.5)	
Airflow Rate	H	cfm (m³/min)	900 (25.5)		730 (20.7)		1690 (47.9)		1796 (50.9)	
	SL		—		—		—		—	
Dimensions (H x W x D)		in. (mm)	21-5/8 x 25-15/16 x 10-3/4 (549 x 659 x 273)				25-11/16 x 33-11/16 x 12-15/16 (652 x 856 x 329)		29-11/16 x 33-11/16 x 12-15/16 (754 x 856 x 329)	
Weight		lbs. (kg)	53 (24)		57 (26)		82 (37)		97 (44)	
Sound Pressure Level		dB(A)	46		48		53		52	

\*Applicable to heat pump models only, refer to installation manual for more details.

Unit Combination		Power Supply				Compressor		OFM		IFM	
Indoor Unit	Outdoor Unit	Hz - Volts	Voltage Range	MCA	MOCP	RLA	W	FLA	W	FLA	
FTXB09AXVJU	RXB09AXVJU	60 - 208	Min. 187 V Max. 253 V	6.95	15	6.75	41	0.19	18	0.2	
		60 - 230									
FTXB12AXVJU	RXB12AXVJU	60 - 208	Min. 187 V Max. 253 V	7.95	15	7.75	41	0.19	18	0.2	
		60 - 230									
FTXB18AXVJU	RXB18AXVJU	60 - 208	Min. 187 V Max. 253 V	16.2	20	16	61	0.5	40	0.24	
		60 - 230									
FTXB24AXVJU	RXB24AXVJU	60 - 208	Min. 187 V Max. 253 V	16.2	20	16	61	0.5	40	0.24	
		60 - 230									



# Daikin 19 series

## Wall-Mounted Cooling Only & Heat Pump

Up to 19 SEER | Up to 10 HSPF

### COMFORTABLE LIMITED WARRANTY\* PROTECTION



\* Complete warranty details available from your local dealer/contractor or at [www.daikincomfort.com](http://www.daikincomfort.com). To receive the 12-Year Parts Limited Warranty, online registration must be completed within 60 days of installation. Online registration is not required in California or Québec. The duration of warranty coverages in Texas differs in some cases. If product installed in a commercial application, limited warranty period is 5 years.

Daikin 19 series is available in both cooling only and heat pump configuration to offer advanced features and energy savings. Wall-mounted units are simple to install and can be placed subtly, high on a wall, where they do not detract from your décor and operate very quietly. Daikin 19 series is offered with an outstanding 12-year limited warranty\* for additional peace of mind.

#### Standard Features

- » Energy Efficient – Up to 19 SEER, up to 10 HSPF, up to 12.5 EER – Variable-Speed, Inverter, Compressor
- » Cooling Range: 50° - 115°F (Extended operation to -4° - 115°F with facility setting and air adjustment grille)
- » Heating Range: 5° - 65°F
- » Indoor Sound Pressure as Low as 19\* dB(A)
- » Outdoor Sound Pressure as Low as 46 dB(A)
- » Washable Air Filter
- » Program Dry Function
- » ECO+ Mode
- » Titanium Apatite Photocatalytic Air Purifying Filter
- » Powerful Operation Mode
- » Backlit Wireless Remote Controller
- » Auto-Changeover (Heat Pump Only)
- » Auto-Fan Speed Control
- » Self Diagnostics with Digital Display
- » Auto-Restart after Power Failure
- » Anti-Corrosion Heat Exchanger Treatment
- » Quick Warming Function (Heat Pump)
- » Hot Start Function (Heat Pump)
- » Automatic Defrosting (Heat Pump)

\*Cooling only, on SL fan speed

#### Optional Features

- » Wired controller
- » Compatible with DKN Residential Cloud Wi-Fi Adaptor or DKN Plus Interface

Part Number	Optional Accessories for Indoor Unit
BRC944B2-A08	Wired Remote Controller kit
BRCW901A08	Wired Remote Controller Cord - 8m
DACA-BRCW901P10	Remote Controller Cable, Plenum Rated, 10 ft
DACA-BRCW901P25	Remote Controller Cable, Plenum Rated, 25 ft
BRCW901A03	Wired Remote Controller Cord - 3m
DACA-CP1-1	Mini Aqua Condensate Pump
DACA-CP4-1	Mini White Pump Kit 100-250V
AZAI6WSCDKB	DKN Residential Cloud Wi-Fi Adaptor
AZAI6WSPDKC	Daikin DKN Plus Interface
Part Number	Optional Accessories for Outdoor Unit
DACA-WB-1	Powder Coated Wall-Mounted Bracket
KPW063B4E	Air direction adjustment grille (18 & 24)
KPW937F4	Air direction adjustment grille (09 & 12)
KKG067A41	Back protection wire net (09 & 12)
KEH067A41E(A)	Drain pan Heater (09/12)
KEH063A4EA	Drain pan Heater (18/24)

#### IDEAL SOLUTIONS FOR:

- » Renovations, remodeling and new construction
- » Sun rooms, basements, attics, garages, hot or cold rooms, and more
- » Rooms where floor space comes at a premium or is not available for other application
- » Ceiling void or attic does not allow for a viable duct run option
- » Cooling Only models are an excellent value for space not requiring heating



**ECO+** – An intelligent feature that ensures optimum energy consumption while fulfilling basic human comfort needs. Once activated, set temperature will be adjusted automatically to an optimum energy consumption level.



**Blue Fin Protection** – The hydrophilic coated fin ensures the condensate water moves easily to the drain pan — thus enhancing the cleanliness and lifespan of the cooling coil.



**Titanium Apatite Photocatalytic Air Purifying Filter** – This filter combines the air-purifying filter and titanium apatite photocatalytic deodorizing filter in a single highly effective unit.



**Program Dry Function** – This gives priority to reducing the level of humidity in the room rather than room temperature.



**Simplified Maintenance** – The indoor unit has been re-designed for easier removal of the drain pan, blower wheel, and indoor fan motor (compared to other wall-mounted units).



**Hot Start** – (Heat Pump) When the heating operation starts or when the unit changes from cooling to heating, there is no cold draft.



**Powerful Operation Mode** – Pushing the POWERFUL button on the remote control gives you a boost in cooling or heating power for a 20-minute period, even if the unit is already operating at high capacity.



BRC52B63 – 19 series heat pump wireless remote shown



# Daikin 19 series

## Wall-Mounted Cooling Only

Up to 19 SEER | Up to 12.5 EER

SINGLE ZONE SYSTEMS



Model	Indoor Unit		FTK09AXVJU	FTK12AXVJU	FTK18AXVJU	FTK24AXVJU
	Outdoor Unit		RK09AXVJU	RK12AXVJU	RK18AXVJU	RK24AXVJU
Capacity Rated (Min. ~ Max.)	Btu/h		8,900 (4,400 ~ 10,200)	10,900 (4,400 ~ 13,300)	18,000 (5,500 ~ 20,000)	21,200 (5,500 ~ 24,000)
Moisture Removal	gal/h		0.08	0.19	0.41	0.67
EER Rated			12.5			12.2
SEER			19		18.5	19
Piping Connections	Liquid	in. (mm)	Ø 1/4 (Ø 6.4)			
	Gas		Ø 3/8 (Ø 9.5)		Ø 1/2 (Ø 12.7)	Ø 5/8 (Ø 15.9)
	Drain		Ø 5/8 (Ø 16.0)			
Max. Interunit Piping Length		ft. (m)	65-5/8 (20)		98-1/2 (30)	
Max. Interunit Height Difference			49-1/4 (15)		65-5/8 (20)	
Chargeless			32-13/16 (10)			
Amount of Additional Charge of Refrigerant	oz/ft. (g/m)		0.21 (20)			
Operating Range - Cooling		°F DB	50° - 115°F			
Operating Range - Low-Ambient Cooling**			5° - 115°F			
Operating Range - Cooling with Optional Air Adjustment Grille**			-4° - 115°F			
Indoor Unit			FTK09AXVJU	FTK12AXVJU	FTK18AXVJU	FTK24AXVJU
Airflow Rate	H	cfm (m³/min)	431 (12.2)	436 (12.3)	716 (20.3)	716 (20.3)
	M		322 (9.1)	316 (8.9)	605 (17.1)	605 (17.1)
	L		249 (7.1)	247 (7.0)	467 (13.2)	467 (13.2)
	SL		142 (4.0)	132 (3.7)	395 (11.2)	395 (11.2)
Fan	Speed	Steps	5 Steps, Quiet, Auto			
Air Direction Control			Right, Left, Horizontal, Downward			
Air Filter			Removable, Washable			
Dimensions (H x W x D)	in. (mm)		11-1/3 x 30-29/32 x 9-27/32 (288 X 785 X 250)		11-11/16 X 39-1/2 X 11-1/3 (297 X 1005 X 288)	
Weight	lbs. (kg)		20 (9)	22 (10)	31 (14)	31 (14)
Sound Pressure Level (H / M / L / SL)	dB(A)		43 / 36 / 30 / 19	45 / 37 / 31 / 19	49 / 44 / 38 / 33	53 / 45 / 39 / 34
Outdoor Unit			RK09AXVJU	RK12AXVJU	RK18AXVJU	RK24AXVJU
Compressor	Motor Output	W	-			
Refrigerant	Type		R-410A			
	Charge	lbs. (kg)	1.54 (0.70)	2.09 (0.95)	3.20 (1.45)	3.86 (1.75)
Airflow Rate	H	cfm (m³/min)	1083 (30.7)	1051 (29.8)	2,005 (56.8)	1,908 (54.0)
Dimensions (H x W x D)	in. (mm)		21-11/16 X 26-1/2 X 11-3/16 (550 x 675 x 284)		27-13/32 X 36-5/8 X 13-13/16 (696 X 930 X 351)	
Weight	lbs. (kg)		55 (25)	62 (28)	99 (45)	106 (48)
Sound Pressure Level	H	dB(A)	46	49	54	55

\*\* Cutting a jumper or a dipswitch setting is required. Refer to installation manual.

Unit Combination		Power Supply				Compressor		OFM		IFM	
INDOOR UNIT	OUTDOOR UNIT	Hz - VOLTS	VOLTAGE RANGE	MCA	MOCP	RLA	W	FLA	W	FLA	
FTK09AXVJU	RK09AXVJU	60 - 208	Min. 187 V Max. 253 V	7	15	6.75	41	0.36	38	0.3	
		60 - 230									
FTK12AXVJU	RK12AXVJU	60 - 208	Min. 187 V Max. 253 V	7.8	15	7.5	41	0.47	38	0.36	
		60 - 230									
FTK18AXVJU	RK18AXVJU	60 - 208	Min. 187 V Max. 253 V	13.4	20	13	128	0.99	35	0.5	
		60 - 230									
FTK24AXVJU	RK24AXVJU	60 - 208	Min. 187 V Max. 253 V	13.4	20	13	128	1	35	0.5	
		60 - 230									

# Daikin 19 series

## Wall-Mounted Heat Pump

Up to 19 SEER | Up to 10 HSPF



Model	Indoor Unit		FTX09AXVJU		FTX12AXVJU		FTX18AXVJU		FTX24AXVJU	
	Outdoor Unit		RX09AXVJU		RX12AXVJU		RX18AXVJU		RX24AXVJU	
			Cooling	Heating	Cooling	Heating	Cooling	Heating	Cooling	Heating
Capacity Rated (Min. ~ Max.)	Btu/h		8,900 (4,400 ~ 10,200)	10,000 (4,400 ~ 13,000)	10,900 (4,400 ~ 13,300)	13,500 (4,400 ~ 16,400)	18,000 (5,500 ~ 20,000)	21,600 (5,500 ~ 24,000)	21,200 (5,500 ~ 24,000)	24,000 (5,800 ~ 27,600)
Moisture Removal	gal/h		0.08	—	0.19	—	0.41	—	0.67	—
COP Rated			4.06		3.8		3.6		3.45	
EER Rated			12.5		12.5		12.5		12.2	
SEER			19		19		18.5		19	
HSPF			10		10		9		9	
Piping Connections	Liquid	in. (mm)			Ø 1/4 (Ø 6.4)					
	Gas		Ø 3/8 (Ø 9.5)				Ø 1/2 (Ø 12.7)		Ø 5/8 (Ø 15.9)	
	Drain				Ø 5/8 (Ø 16.0)					
Max. Interunit Piping Length	ft. (m)		65-5/8 (20)				98-1/2 (30)			
Max. Interunit Height Difference	ft. (m)		49-1/4 (15)				65-5/8 (20)			
Chargeless					32-13/16 (10)					
Amount of Additional Charge of Refrigerant	oz/ft. (g/m)				0.21 (20)					
Operating Range - Cooling	°F DB				50° - 115°F					
Operating Range - Low-Ambient Cooling**	°F DB				5° - 115°F					
Operating Range - Cooling with Optional Air Adjustment Grille**	°F DB				-4° - 115°F					
Operating Range - Heating*	°F WB				5° - 65°F					
Indoor Unit			FTX09AXVJU		FTX12AXVJU		FTX18AXVJU		FTX24AXVJU	
Airflow Rate	H	(cfm) m³/min	431 (12.2)	402 (11.4)	436 (12.3)	412 (11.7)	716 (20.3)	716 (20.3)	716 (20.3)	716 (20.3)
	M		322 (9.1)	322 (9.1)	316 (8.9)	316 (8.9)	605 (17.1)	605 (17.1)	605 (17.1)	605 (17.1)
	L		249 (7.1)	249 (7.1)	247 (7.0)	247 (7.0)	467 (13.2)	467 (13.2)	467 (13.2)	467 (13.2)
	SL		219 (6.2)	219 (6.2)	210 (5.9)	210 (5.9)	395 (11.2)	395 (11.2)	395 (11.2)	395 (11.2)
Fan	Speed	Steps	5 Steps, Quiet, Auto							
Air Direction Control			Right, Left, Horizontal, Downward							
Air Filter			Removable, Washable							
Dimensions (H x W x D)	in. (mm)		11-1/3 x 30-29/32 x 9-27/32 (288 x 785 x 250)				11-11/16 x 39-1/2 x 11-1/3 (297 x 1005 x 288)			
Weight	lbs. (kg)		20 (9)		22 (10)		31(14)			
Sound Pressure Level (H / M / L / SL)	dB(A)		43 / 36 / 30 / 25	43 / 36 / 29 / 25	45 / 37 / 31 / 26	45 / 37 / 30 / 26	49 / 44 / 38 / 33	49 / 42 / 37 / 33	53 / 45 / 39 / 34	53 / 43 / 37 / 34
Outdoor Unit			RX09AXVJU		RX12AXVJU		RX18AXVJU		RX24AXVJU	
Compressor	Motor Output	W	—							
Refrigerant	Type	R-410A								
	Charge	lbs. (kg)	1.54 (0.70)		2.09 (0.95)		2.49 (1.13)		3.20 (1.45)	
Airflow Rate	H	(cfm) m³/min	1083 (30.7)	1,103 (31.2)	1051 (29.8)	966 (27.4)	2,005 (56.8)	1,905 (53.9)	1,908 (54.0)	1,908 (54.0)
Dimensions (H x W x D)	in. (mm)		21-11/16 x 26-1/2 x 11-3/16 (550 x 675 x 284)				27-13/32 x 36-5/8 x 13-13/16 (696 x 930 x 351)			
Weight	lbs. (kg)		57 (26)		64 (29)		101 (46)		106 (48)	
Sound Pressure Level	H	dB(A)	46	48	49		54		55	

\*\* Cutting a jumper or a dipswitch setting is required. Refer to installation manual.

Unit Combination		Power Supply				Compressor	OFM		IFM	
INDOOR UNIT	OUTDOOR UNIT	Hz - VOLTS	VOLTAGE RANGE	MCA	MOCP	RLA	W	FLA	W	FLA
FTX09AXVJU	RX09AXVJU	60 - 208	Min. 187 V Max. 253 V	12.1	15	8.5	41	0.36	38	0.3
		60 - 230								
FTX12AXVJU	RX12AXVJU	60 - 208	Min. 187 V Max. 253 V	12.2	15	8.5	41	0.47	38	0.36
		60 - 230								
FTX18AXVJU	RX18AXVJU	60 - 208	Min. 187 V Max. 253 V	18.3	20	10.8	128	0.99	35	0.5
		60 - 230								
FTX24AXVJU	RX24AXVJU	60 - 208	Min. 187 V Max. 253 V	18.3	20	12	128	1	35	0.5
		60 - 230								







# Daikin EMURA

## Wall-Mounted Heat Pump

Up to 18 SEER | Up to 10 HSPF

### COMFORTABLE LIMITED WARRANTY\* PROTECTION



\* Complete warranty details available from your local dealer/contractor or at [www.daikincomfort.com](http://www.daikincomfort.com). To receive the 12-Year Parts Limited Warranty, online registration must be completed within 60 days of installation. Online registration is not required in California or Québec. The duration of warranty coverages in Texas differs in some cases. *If product installed in a commercial application, limited warranty period is 5 years.*

The next generation of home air conditioning is here, offering smart technology within a sleek, curved silhouette. Daikin EMURA air conditioners are designed to satisfy a uniquely “Designer” sense of style.

Offering a sophisticated solution for contemporary interiors, the new Daikin EMURA single zone system combines form and functionality to create an icon of contemporary climate control. Available in silver or pure matte white, Daikin EMURA makes a modern design statement on any wall.

### Standard Features

- » Energy Efficient – Up to 18 SEER, up to 10 HSPF, up to 11 EER
- » Cooling Range: 50° - 115°F (Extended operation to -4° - 115°F with facility setting and air adjustment grille)
- » Heating Range: 5° - 65°F
- » Redesigned PCB in the outdoor unit to withstand extreme conditions
- » Indoor Sound Pressure as Low as 19\* dB(A)
- » Outdoor Sound Pressure as Low as 46 dB(A)
- » Washable Air Filter
- » Program Dry Function
- » Econo Mode
- » Titanium Apatite Photocatalytic Air Purifying Filter
- » Powerful Operation Mode
- » Backlit Wireless Remote Controller
- » Outdoor Unit Quiet Operation
- » Auto-Changeover
- » Auto-Fan Speed Control
- » Self Diagnostics with Digital Display
- » Auto-Restart After Power Failure
- » Anti-Corrosion Heat Exchanger Treatment
- » Quick Warming Function
- » Hot Start Function
- » Automatic Defrosting

\*On SL fan speed

### Optional Features

- » Wired controller
- » Compatible with Daikin One+ Smart Thermostat, DKN Residential Cloud Wi-Fi Adaptor, or DKN Plus Interface

### IDEAL SOLUTIONS FOR:

- » Hot & cold regions where homeowners want to enjoy a reliable, energy efficient source of heating and cooling
- » Cold regions where homeowners want to enjoy a reliable, energy efficient source of heat
- » Renovations, remodeling and new construction
- » Sun rooms, basements, attics, garages, hot or cold rooms, and more
- » Rooms where floor space comes at a premium or is not available for other application
- » Ceiling void or attic does not allow for a viable duct run option



**2-Area Intelligent Eye** – The two-area intelligent eye sensor controls comfort in two ways. If the room is empty for 20 minutes, it changes the set point to start saving energy. As soon as someone enters the room, it immediately returns to the original setting. The intelligent eye also directs air flow away from people in the room to avoid cold drafts.



**3-D Airflow** – To ensure a harmonized temperature throughout the room, the Daikin EMURA 3D air flow system combines vertical and horizontal auto-swing creating an even distribution of air throughout the room to the corners of even large spaces.



**Comfort Mode** – Draft-free operation improves comfort. When cooling, the flap positions itself horizontally to prevent cold airflow from being blown directly onto the body. When heating, the flap turns vertically downwards to drive warm air to the bottom of the room.



**Night Set Mode** – Rapid changes in room temperature can disturb your sleep. To avoid this, Daikin EMURA prevents overheating or over-cooling during the night. If the timer is switched on, the unit will automatically set the temperature to 0.9°F warmer in cooling and 3.6°F cooler in heating.



**Titanium Apatite Photocatalytic Air Purifying Filter** – This filter combines the air-purifying filter and titanium apatite photocatalytic deodorizing filter in a single highly effective unit.

Part Number	Optional Accessories for Indoor Unit	Part Number	Optional Accessories for Outdoor Unit	Part Number	Optional Accessories for Outdoor Unit
BRC944B2-A08	Wired Remote Controller kit	DACA-WB-1	Powder-Coated Wall-Mounted Bracket	KPS063A41	Snow hood (intake side plate) (18)
BRCW901A08	Wired Remote Controller Cord - 8m	KPW063B4	Air direction adjustment grille (18)	KPS063A44	Snow hood (intake rear plate) (18)
DACA-BRCW901P10	Remote Controller Cable, Plenum Rated, 10 ft	KPW937F4	Air direction adjustment grille (09 & 12)	KPS063A47	Snow hood (outlet) (18)
DACA-BRCW901P25	Remote Controller Cable, Plenum Rated, 25 ft	KEH067A41E(A)	Daikin BMS Drain Pan Heater Small (09 & 12)	KKP937A4	Drain Plug for OD Unit
KAF970A46	Titanium apatite photocatalytic air-purifying filter WITHOUT frame	KEH063A4E	Daikin BML Drain Pan Heater Large (18)	KPS067A42	Snow hood (intake rear plate) (09 & 12)
DACA-CP4-1	Condensate Pump	KKG067A41	Back protection wire net (09 & 12)	KPS067A44	Snow hood (outlet) (09)
DACA-CP1-1	Inline Condensate Pump	KKG063A42	Back protection wire net (18)		
DTST-ONE-ADA-A	Daikin One+ Smart Thermostat	KPS067A41	Snow hood (intake side plate) (09 & 12)		
AZAI6WSCKDB	DKN Residential Cloud Wi-Fi Adaptor	RAQAHG2	Rear coil guard (09 & 12)		
AZAI6WSPDKC	Daikin DKN Plus Interface	RAQAHG1	Rear coil guard (18)		

# Daikin EMURA

## Wall-Mounted Heat Pump

Up to 18 SEER | Up to 10 HSPF

SINGLE ZONE SYSTEMS



Model	Indoor Unit		FTXR09TVJUW/S RX09RMVJU9A		FTXR12TVJUW/S RX12RMVJU9A		FTXR18TVJUW/S RX18RMVJU9A	
	Outdoor Unit		Cooling	Heating	Cooling	Heating	Cooling	Heating
Capacity Rated (Min. - Max.)	Btu/h		9,000 (4,500 ~ 10,600)	10,000 (4,100 ~ 14,600)	12,000 (4,500 ~ 12,800)	13,500 (4,100 ~ 15,800)	18,000 (5,100 ~ 18,500)	20,000 (5,800 ~ 21,200)
COP Rated			4		3.58		3.34	
EER Rated			11				9.6	
SEER			18		17		14.5	
HSPF			9.3		10		9.8	
Piping Connections	Liquid	in. (mm)	Ø 1/4 (Ø 6.4)					
	Gas		Ø 3/8 (Ø 9.5)				Ø 1/2 (Ø 12.7)	
	Drain		Ø 11/16 (Ø 18.0)					
Max. Interunit Piping Length	ft. (m)		65-5/8 (20)		98-1/2 (30)		49-1/4 (15)	
Max. Interunit Height Difference			Chargeless		32-13/16 (10)		0.21 (20)	
Amount of Additional Charge of Refrigerant	oz./ft. (g/m)		Operating Range - Cooling		50° - 115°F		14° - 115°F	
Operating Range - Cooling			Operating Range - Low-Ambient Cooling*		-4° - 115°F		5° - 65°F	
Operating Range - Cooling with Optional Air Adjustment Grille*			Operating Range - Heating <sup>1</sup>					
Operating Range - Heating <sup>1</sup>	°F WB							
Airflow Rate	Indoor Unit		FTXR09TVJUW/S		FTXR12TVJUW/S		FTXR18TVJUW/S	
	H	cfm (m <sup>3</sup> /min)	272 (7.7)	346 (9.8)	335 (9.5)	395 (11.2)	350 (9.9)	413 (11.7)
	M		208 (5.9)	258 (7.3)	219 (6.2)	290 (8.2)	275 (7.8)	332 (9.4)
	L		162 (4.6)	201 (5.7)	169 (4.8)	226 (6.4)	226 (6.4)	275 (7.8)
SL	134 (3.8)		117 (3.3)	131 (3.7)	131 (3.7)	208 (5.9)	208 (5.9)	
Fan	Speed	Steps	5 Steps, Quiet, Auto					
Air Direction Control			Right, Left, Horizontal, Downward					
Air Filter			Removable, Washable					
Dimensions (H × W × D)	in. (mm)		11-15/16 × 39-5/16 × 8-3/8 (303 × 998 × 212)					
Weight	lbs. (kg)		27 (12)				27 (12)	
Sound Pressure Level (H / M / L / SL)	dB(A)		38 / 32 / 25 / 19	41 / 34 / 28 / 19	45 / 34 / 26 / 20	45 / 37 / 29 / 20	46 / 40 / 35 / 30	47 / 41 / 35 / 30
Refrigerant	Outdoor Unit		RX09RMVJU9A		RX12RMVJU9A		RX18RMVJU9A	
	Type	R-410A						
	Charge	lbs. (kg)	2.09 (0.95)				2.49 (1.13)	
Airflow Rate	H	cfm (m <sup>3</sup> /min)	985 (27.9)	1130 (32)	1,105 (31.3)	1,130 (32)	2,461 (69.7)	2,553 (72.3)
Dimensions (H × W × D)	in. (mm)		21-5/8 × 26-9/16 × 11-3/16 (550 × 675 × 284)				28-15/16 × 34-1/4 × 12-5/8 (735 × 870 × 320)	
Weight	lbs. (kg)		60 (27)		60 (27)		97 (44)	
Sound Pressure Level H	dB(A)		46	50	49	51	54	55

\* Cutting a jumper or a dipswitch setting is required. Refer to installation manual.

Unit Combination		Power Supply				Compressor		OFM		IFM	
INDOOR UNIT	OUTDOOR UNIT	Hz - VOLTS	VOLTAGE RANGE	MCA	MOCP	RLA	W	FLA	W	FLA	
FTXR09TVJUW/S	RX09RMVJU9A	60 - 208	Min. 187 V Max. 253 V	9	15	7.5	39	0.13	29	0.13	
		60 - 230									
FTXR12TVJUW/S	RX12RMVJU9A	60 - 208	Min. 187 V Max. 253 V	9.1	15	7.5	39	0.15	29	0.19	
		60 - 230									
FTXR18TVJUW/S	RX18RMVJU9A	60 - 208	Min. 187 V Max. 253 V	12.8	15	10.75	110	0.38	29	0.21	
		60 - 230									

# Daikin **AURORA**

## Wall-Mounted Heat Pump

Up to 20.3 SEER | Up to 12.5 HSPF

### COMFORTABLE LIMITED WARRANTY\* PROTECTION



\* Complete warranty details available from your local dealer/contractor or at [www.daikincomfort.com](http://www.daikincomfort.com). To receive the 12-Year Parts Limited Warranty, online registration must be completed within 60 days of installation. Online registration is not required in California or Québec. The duration of warranty coverages in Texas differs in some cases.  
If product installed in a commercial application, limited warranty period is 5 years.

Living in colder climates doesn't mean a heat pump isn't a viable option to heat each space in your home or business, nor does living in warmer climates preclude the use of a heat pump as a viable option for cooling. The outdoor units of this Daikin **AURORA** heat pump system have been redesigned to withstand extreme weather conditions, even when it is down to -13°F WB (-25°C WB) or up to 115°F DB (46°C DB) for year round comfort.

### Standard Features

- » Energy Efficient – Up to 20.3 SEER, up to 12.5 HSPF, up to 13 EER
  - » Up to 100% rated cooling capacity at 104°F DB (40°C DB).
  - » Cooling Range: 50° - 115°F (Extended operation to -4° - 115°F with facility setting and air adjustment grille)
  - » Heating Range: -13° - 60°F
  - » Redesigned PCB in the outdoor unit to withstand extreme conditions
  - » Indoor Sound Pressure as Low as 19\* dB(A)
  - » Outdoor Sound Pressure as Low as 49 dB(A)
  - » Washable Air Filter
  - » Program Dry Function
  - » Econo Mode
  - » Titanium Apatite Photocatalytic Air Purifying Filter
  - » Powerful Operation Mode
  - » Backlit Wireless Remote Controller
  - » Outdoor Unit Quiet Operation
  - » Auto-Changeover
  - » Auto-Fan Speed Control
  - » Self Diagnostics with Digital Display
  - » Auto-Restart After Power Failure
  - » Anti-Corrosion Heat Exchanger Treatment
  - » Quick Warming Function
  - » Hot Start Function
  - » Automatic Defrosting
- \*On SL fan speed

### Optional Features

- » Wired controller
- » Compatible with Daikin *One+* Smart Thermostat, DKN Residential Cloud Wi-Fi Adaptor, or DKN Plus Interface

### IDEAL SOLUTIONS FOR:

- » Hot & cold regions where homeowners want to enjoy a reliable, energy efficient source of heating and cooling
- » Cold regions where homeowners want to enjoy a reliable, energy efficient source of heat
- » Renovations, remodeling and new construction
- » Sun rooms, basements, attics, garages, hot or cold rooms, and more
- » Rooms where floor space comes at a premium or is not available for other application
- » Ceiling void or attic does not allow for a viable duct run option



**Daikin *AURORA* heat pump for extreme weather conditions** – Up to 100% rated heating capacity at 5°F WB (-15°C WB) and confirmed continuous operation, as low as -13°F WB (-25°C WB) ambient temperature.



**Auto-Restart** – The unit memorizes the operation mode, airflow and temperature settings. Should there be a power failure when the unit is in operation, it will automatically return to the same operating conditions when the power is restored.



**Titanium Apatite Photocatalytic Air Purifying Filter** – This filter combines the air-purifying filter and titanium apatite photocatalytic deodorizing filter in a single highly effective unit.



**Comfort Mode** – Comfort Mode operation improves comfort. When cooling, the flap positions itself horizontally to prevent cold airflow from being blown directly onto the body. When heating, the flap turns vertically downwards to drive warm air to the bottom of the room.



**Hot Start** – (Heat Pump) When the heating operation starts or when the unit changes from cooling to heating, there is no cold draft.



**Powerful Operation Mode** – Pushing the POWERFUL button on the remote control gives you a boost in cooling or heating power for a 20-minute period, even if the unit is already operating at high capacity.

Part Number	Optional Accessories for Indoor Unit	Part Number	Optional Accessories for Outdoor Unit	Part Number	Optional Accessories for Outdoor Unit
BRC944B2-A08	Wired Remote Controller kit (Adaptor Required)	DACA-WB-1	Powder-Coated Wall-Mounted Bracket	KPS063A41	Snow hood (intake side plate) (15, 18 & 24)
BRCW901A08	Wired Remote Controller Cord - 8m	KPW063B4	Air direction adjustment grille (15, 18 & 24)	KPS063A44	Snow hood (intake rear plate) (15, 18 & 24)
DACA-BRCW901P10	Remote Controller Cable, Plenum Rated, 10 ft	KPW937F4	Air direction adjustment grille (09 & 12)	KPS063A47	Snow hood (outlet) (15, 18 & 24)
DACA-BRCW901P25	Remote Controller Cable, Plenum Rated, 25 ft	KEH067A41E(A)	Daikin BMS Drain Pan Heater Small (09 & 12)	KKP937A4	Drain Plug for OD Unit
KRP980B2E	Adaptor for wired remote controller (15)	KEH063A4E	Daikin BML Drain Pan Heater Large (15, 18 & 24)		
KRP067A41	Adaptor for wired remote controller (09 & 12)	KKG063A41	Back protection wire net (09 & 12)		
KAF970A45	Titanium apatite photocatalytic air-purifying filter WITH frame	KKG063A42	Back protection wire net (15, 18 & 24)		
KAF970A46	Titanium apatite photocatalytic air-purifying filter WITHOUT frame	KPS067A41	Snow hood (intake side plate) (09 & 12)		
DACA-CP3-1	Condensate Pump (Fits inside all Daikin indoor unit heads)	KPS067A42	Snow hood (intake rear plate) (09 & 12)		
DTST-ONE-ADA-A	Daikin <i>One+</i> Smart Thermostat	KPS067A44	Snow hood (outlet) (09 & 12)		
AZAI6WSCDKB	DKN Residential Cloud Wi-Fi Adaptor	RAQAHLGD2	Rear coil guard (09 & 12)		
AZAI6WSPDKC	Daikin DKN Plus Interface	RAQAHLGD1	Rear coil guard (15, 18 & 24)		

# Daikin AURORA

## Wall-Mounted Heat Pump

Up to 20.3 SEER | Up to 12.5 HSPF



Our outdoor unit drain pans have up to 14 holes which allows for effective drainage of condensation. In some cases, this improved drain pan design eliminates the need for drain pan heaters, resulting in higher efficiencies in low ambient temperatures.

SINGLE ZONE SYSTEMS

Model	Indoor Unit		FTX09NMVJUA RXL09QMVJUA		FTX12NMVJUA RXL12QMVJU9A		FTX15NMVJUA RXL15QMVJUA		FTX18UVJU RXL18UMVJUA		FTX24UVJU RXL24UMVJUA	
	Outdoor Unit		Cooling	Heating	Cooling	Heating	Cooling	Heating	Cooling	Heating	Cooling	Heating
Capacity Rated (Min. ~ Max.)	Btu/h		9,000 (4,400 ~ 10,900)	10,900 (4,400 ~ 16,000)	10,600 (4,400 ~ 13,300)	13,400 (4,400 ~ 18,800)	15,000 (5,800 ~ 18,400)	18,300 (5,800 ~ 24,600)	18,000 (9,000 ~ 21,600)	21,600 (9,000 ~ 28,000)	21,200 (9,000 ~ 25,800)	24,000 (9,000 ~ 32,000)
Moisture Removal	gal/h		0.32	—	0.45	—	0.63	—	—	—	—	—
COP Rated			4.20		3.90		4.00		3.5		3.3	
EER Rated			12.5				13		12.5		20	
SEER			12.5		12		12.5		10.3		20	
Piping Connections	Liquid	in. (mm)	Ø 3/8 (Ø 9.5)				Ø 1/4 (Ø 6.4)		Ø 1/2 (Ø 12.7)		Ø 5/8 (Ø 15.9)	
	Gas											
	Drain						Ø 5/8 (Ø 16.0)					
Max. Interunit Piping Length			65-5/8 (20)						98-1/2 (30)			
Max. Interunit Height Difference		ft. (m)	49-1/4 (15)						65-5/8 (20)			
Chargeless							32-13/16 (10)					
Amount of Additional Charge of Refrigerant	oz/ft. (g/m)		0.21 (20)						0.32 (30)			
Operating Range - Cooling		°F DB					50° - 115°F					
Operating Range - Low-Ambient Cooling*							5° - 115°F					
Operating Range - Cooling with Optional Air Adjustment Grille*							-4° - 115°F					
Operating Range - Heating†	°F WB		-13° - 60°F		-13° - 65°F		-13° - 60°F				-13° - 65°F	
Indoor Unit			FTX09NMVJUA		FTX12NMVJUA		FTX15NMVJUA		FTX18UVJU		FTX24UVJU	
Airflow Rate	H	cfm (m³/min)	417 (11.8)	403 (11.4)	434 (12.3)	413 (11.7)	593 (16.8)	653 (18.5)	583 (16.5)	713 (20.2)	643 (18.2)	699 (19.8)
	M		297 (8.4)	328 (9.3)	311 (8.8)	321 (9.1)	505 (14.3)	554 (15.7)	484 (13.7)	583 (16.5)	494 (14.0)	572 (16.2)
	L		244 (6.9)	251 (7.1)	247 (7.0)	258 (7.3)	431 (12.2)	470 (13.3)	385 (10.9)	431 (12.2)	350 (9.9)	445 (12.6)
	SL		141 (4.0)	215 (6.1)	145 (4.1)	219 (6.2)	367 (10.4)	399 (11.3)	360 (10.2)	399 (11.3)	328 (9.3)	403 (11.4)
Fan	Speed	Steps	5 Steps, Quiet, Auto									
Air Direction Control	Right, Left, Horizontal, Downward											
Air Filter	Removable, Washable											
Dimensions (H x W x D)	in. (mm)	11-1/4 x 30-5/16 x 8-3/4 (285 x 770 x 223)					11-5/8 x 39 x 10-3/8 (295 x 990 x 263)			13-3/8 x 41-5/16 x 10-1/4 (340 x 1,050 x 261)		
Weight	lbs. (kg)	18 (8)					27 (12)			33 (15)		
Sound Pressure Level (H / M / L / SL)	dB(A)	43 / 36 / 30 / 19	43 / 36 / 29 / 25	45 / 37 / 30 / 19	45 / 37 / 30 / 26	45 / 41 / 36 / 33	45 / 41 / 37 / 33	46 / 41 / 36 / 33	48 / 42 / 35 / 32	51 / 44 / 37 / 34	48 / 42 / 37 / 34	
Outdoor Unit			RXL09QMVJUA		RXL12QMVJU9A		RXL15QMVJUA		RXL18UMVJUA		RXL24UMVJUA	
Compressor	Motor Output	W	790				1,100				—	
Refrigerant	Type	R-410A										
	Charge	lbs. (kg)	2.09 (0.95)				3.20 (1.45)		3.53 (1.60)			
Airflow Rate	H	cfm	1,105 (31.3)	922 (26.1)	1,144 (32.4)	1,006 (28.5)	2,044 (57.9)	2,044 (57.9)	2,417 (68.5)	2,361 (66.9)	2,417 (68.5)	2,361 (66.9)
	SL	(m³/min)	865 (24.5)	777 (22.0)	865 (24.5)	777 (22.0)	1,762 (49.9)	1,585 (44.9)	1,907 (54.0)	2,134 (60.4)	1,907 (54.0)	2,134 (60.4)
Dimensions (H x W x D)	in. (mm)	21-5/8 x 26-9/16 x 11-3/16 (550 x 675 x 284)					28-15/16 x 34-1/4 x 12-5/8 (735 x 870 x 320)					
Weight	lbs. (kg)	60 (27)		70 (32)		108 (49)				130 (59)		
Sound Pressure Level	H	dB(A)	49		50		50	55	54	55	55	

\* Cutting a jumper or a dipswitch setting is required. Refer to installation manual.

† The installation of an optional drain-pan is recommended in areas where ambient temperature may fall below 5°F (-15°C) or in areas of heavy snowfall or high levels of wintertime humidity.

Unit Combination		Power Supply				Compressor	OFM		IFM	
INDOOR UNIT	OUTDOOR UNIT	Hz - Volts	VOLTAGE RANGE	MCA	MOCP	RLA	W	FLA	W	FLA
FTX09NMVJUA	RXL09QMVJUA	60-208	Min. 187 V Max. 253 V	9.5	15	8.5	18	0.15	21	0.20
		60-230								
FTX12NMVJUA	RXL12QMVJU9A	60-208	Min. 187 V Max. 253 V	13	15	12	20	0.17	28	0.23
		60-230								
FTX15NMVJU	RXL15QMVJUA	60-208	Min. 187 V Max. 253 V	13	15	11.8	71	0.47	33	0.23
		60-230								
FTX18UVJU	RXL18UMVJUA	60-208	Min. 187 V Max. 253 V	18.7	20	18.25	76	0.47	48	0.37
		60-230								
FTX24UVJU	RXL24UMVJUA	60-208	Min. 187 V Max. 253 V	18.9	20	18.25	76	0.47	48	0.57
		60-230								

# Daikin *AURORA*

## Floor-Mounted Heat Pump

Up to 20 SEER | Up to 11.7 HSPF

### COMFORTABLE LIMITED WARRANTY\* PROTECTION



\* Complete warranty details available from your local dealer/contractor or at [www.daikincomfort.com](http://www.daikincomfort.com). To receive the 12-Year Parts Limited Warranty, online registration must be completed within 60 days of installation. Online registration is not required in California or Québec. The duration of warranty coverages in Texas differs in some cases. *If product installed in a commercial application, limited warranty period is 5 years.*

Daikin *AURORA* floor-mounted units are simple to install and can be setup in various configurations, on the floor or hanging low on a wall. Its low height enables the unit to fit perfectly beneath a window. The airflow distribution pattern of Daikin's floor-mounted unit is ideal for heating or cooling a space, and is a perfect replacement to traditional radiant systems. For all regions, the outdoor units of this Daikin *AURORA* heat pump system have been redesigned to withstand extreme weather conditions, even when it is down to -13°F WB (-25°C WB) or up to 115°F DB (46°C DB) for year round comfort.

### Standard Features

- » Energy Efficient – Up to 20 SEER, 11.7 HSPF, 12.5 EER
- » Up to 100% rated cooling capacity at 104°F DB (40°C DB).
- » Cooling Range: 50° - 115°F (Extended operation to -4° - 115°F with facility setting and air adjustment grille)
- » Heating Range: -13° - 60°F
- » Redesigned PCB in the outdoor unit to withstand extreme conditions
- » Indoor Sound Pressure as Low as 23\* dB(A)
- » Outdoor Sound Pressure as Low as 49 dB(A)
- » Washable Air Filter
- » Program Dry Function
- » Econo Mode
- » Titanium Apatite Photocatalytic Air Purifying Filter
- » Powerful Operation Mode
- » Backlit Wireless Remote Controller
- » Outdoor Unit Quiet Operation
- » Auto-Changeover
- » Auto-Fan Speed Control
- » Self Diagnostics with Digital Display
- » Auto-Restart After Power Failure
- » Anti-Corrosion Heat Exchanger Treatment
- » Quick Warming Function
- » Hot Start Function
- » Automatic Defrosting

\*On SL fan speed

### Optional Features

- » Wired controller
- » Compatible with Daikin *One+* Smart Thermostat, DKN Residential Cloud Wi-Fi Adaptor, or DKN Plus Interface

### IDEAL SOLUTIONS FOR:

- » Hot & cold regions where homeowners want to enjoy a reliable, energy efficient source of heating and cooling
- » Cold regions where homeowners want to enjoy a reliable, energy efficient source of heat
- » Renovations, remodeling and new construction
- » Sun rooms, basements, garages, hot or cold rooms, attics where the walls tend to be lower, or wherever wall space is at a premium
- » Ceiling void or attic does not allow for a viable duct run option



**Daikin *AURORA* heat pump for extreme weather conditions** – Up to 100% rated heating capacity at 5°F WB (-15°C WB) and confirmed continuous operation, as low as -13°F WB (-25°C WB) ambient temperature.



**Auto-Restart** – The unit memorizes the operation mode, airflow and temperature settings. Should there be a power failure when the unit is in operation, it will automatically return to the same operating conditions when the power is restored.



**Titanium Apatite Photocatalytic Air Purifying Filter** – This filter combines the air-purifying filter and titanium apatite photocatalytic deodorizing filter in a single highly effective unit.



**Comfort Mode** – Comfort Mode operation improves comfort. When cooling, the flap positions itself horizontally to prevent cold airflow from being blown directly onto the body. When heating, the flap turns vertically downwards to drive warm air to the bottom of the room.



**Hot Start** – (Heat Pump) When the heating operation starts or when the unit changes from cooling to heating, there is no cold draft.



**Powerful Operation Mode** – Pushing the POWERFUL button on the remote control gives you a boost in cooling or heating power for a 20-minute period, even if the unit is already operating at high capacity.

Part Number	Optional Accessories for Indoor Unit	Part Number	Optional Accessories for Outdoor Unit	Part Number	Optional Accessories for Outdoor Unit
BRC944B2-A08	Wired Remote Controller kit (Adaptor Required)	DACA-WB-1	Powder-Coated Wall-Mounted Bracket	KPS067A41	Snow hood (intake side plate) (09 & 12)
BRCW901A08	Wired Remote Controller Cord - 8m	KPW063B4	Air direction adjustment grille (15)	KPS067A42	Snow hood (intake rear plate) (09 & 12)
DACA-BRCW901P10	Remote Controller Cable, Plenum Rated, 10 ft	KPW937F4	Air direction adjustment grille (09 & 12)	KPS067A44	Snow hood (outlet) (09 & 12)
DACA-BRCW901P25	Remote Controller Cable, Plenum Rated, 25 ft	KEH067A41E(A)	Daikin BMS Drain Pan Heater Small (09 & 12)	KPS063A41	Snow hood (intake side plate) (15)
KAF968B42	Titanium apatite photocatalytic air-purifying filter WITH frame	KEH063A4E	Daikin BML Drain Pan Heater Large (15)	KPS063A44	Snow hood (intake rear plate) (15)
DACA-CP3-1	Condensate Pump (Fits inside all Daikin indoor unit heads)	KKG067A41	Back protection wire net (09 & 12)	KPS063A47	Snow hood (outlet) (15)
DTS1-ONE-ADA-A	Daikin <i>One+</i> Smart Thermostat	KKG063A42	Back protection wire net (15)	KKP937A4	Drain Plug for OD Unit
AZA16WSCDKB	DKN Residential Cloud Wi-Fi Adaptor	RAQAHLGD2	Rear coil guard (09 & 12)		
AZA16WSPDKC	Daikin DKN Plus Interface	RAQAHLGD1	Rear coil guard (15)		



# Daikin AURORA

## Floor-Mounted Heat Pump

Up to 20 SEER | Up to 11.7 HSPF

SINGLE ZONE SYSTEMS



Our outdoor unit drain pans have up to 14 holes which allows for effective drainage of condensation. In some case, this improved drain pan design eliminates the need for drain pan heaters, resulting in higher efficiencies in low ambient temperatures.

Model	Indoor Unit		FVXS09NVJU		FVXS12NVJU		FVXS15NVJU	
	Outdoor Unit		RXL09QMVJUA		RXL12QMVJU9A		RXL15QMVJUA	
			Cooling	Heating	Cooling	Heating	Cooling	Heating
Capacity Rated (Min. ~ Max.)		Btu/h	9,000 (4,400 ~ 10,200)	10,100 (4,400 ~ 14,300)	10,200 (4,400 ~ 12,300)	13,000 (4,400 ~ 17,100)	15,000 (5,800 ~ 17,100)	18,000 (5,800 ~ 24,000)
Moisture Removal		gal/h	0.32	—	0.45	—	0.63	—
COP Rated			4.10		4.00		3.76	
EER Rated			12.5		12.0		12.5	
SEER					20			
HSPF			11.7		11.4		11.3	
Piping Connections	Liquid	in. (mm)			Ø 1/4 (Ø 6.4)			
	Gas				Ø 3/8 (Ø 9.5)		Ø 1/2 (Ø 12.7)	
	Drain				Ø 13/16 (Ø 20.0)			
Max. Interunit Piping Length		ft. (m)			65-5/8 (20)		98-1/2 (30)	
Max. Interunit Height Difference					49-1/4 (15)		65-5/8 (20)	
Chargeless					32-13/16 (10)			
Amount of Additional Charge of Refrigerant		oz/ft. (g/m)			0.21 (20)			
Operating Range - Cooling		°F DB			50° - 115°F			
Operating Range - Low-Ambient Cooling*					5° - 115°F			
Operating Range - Cooling with Optional Air Adjustment Grille*					-4° - 115°F			
Operating Range - Heating†		°F WB	-13° - 60°F		-13° - 65°F		-13° - 60°F	
<b>Indoor Unit</b>			<b>FVXS09NVJU</b>		<b>FVXS12NVJU</b>		<b>FVXS15NVJU</b>	
Airflow Rate	H	cfm (m³/min)	290 (8.2)	311 (8.8)	300 (8.5)	332 (9.4)	378 (10.7)	417 (11.8)
	M		230 (6.5)	244 (6.9)	237 (6.7)	258 (7.3)	325 (9.2)	357 (10.1)
	L		169 (4.8)	177 (5.0)	173 (4.9)	184 (5.2)	275 (7.8)	300 (8.5)
	SL		145 (4.1)	155 (4.4)	159 (4.5)	166 (4.7)	233 (6.6)	251 (7.1)
Fan	Speed	Steps	5 Steps, Quiet, Auto					
Air Direction Control			Right, Left, Horizontal, Downward					
Air Filter			Removable, Washable					
Dimensions (H x W x D)		in. (mm)	23-5/8 x 27-9/16 x 8-1/4 (600 x 700 x 210)					
Weight		lbs. (kg)	31 (14)					
Sound Pressure Level (H / M / L / SL)		dB(A)	38 / 32 / 26 / 23	38 / 32 / 26 / 23	39 / 33 / 27 / 24	39 / 33 / 27 / 24	44 / 40 / 36 / 32	45 / 40 / 36 / 32
<b>Outdoor Unit</b>			<b>RXL09QMVJUA</b>		<b>RXL12QMVJU9A</b>		<b>RXL15QMVJUA</b>	
Compressor	Motor Output	W	790		1,100			
Refrigerant	Type	R-410A						
	Charge	lbs. (kg)	2.09 (0.95)		3.20 (1.45)			
Airflow Rate	H	cfm (m³/min)	1,106 (31.3)	922 (26.1)	1,114 (32.4)	2,045 (57.9)	2,044 (57.9)	2,044 (57.9)
	SL		865 (24.5)	777 (22.0)	865 (24.5)	777 (22.0)	1,762 (49.9)	1,585 (44.9)
Dimensions (H x W x D)		in. (mm)	21-5/8 x 26-9/16 x 11-3/16 (550 x 675 x 284)				28-15/16 x 34-1/4 x 12-5/8 (735 x 870 x 320)	
Weight		lbs. (kg)	60 (27)		70 (32)		108 (49)	
Sound Pressure Level	H	dB(A)	49		50		50	55

\* Cutting a jumper or a dipswitch setting is required. Refer to installation manual.

† The installation of an optional drain-pan is recommended in areas where ambient temperature may fall below 5°F (-15°C) or in areas of heavy snowfall or high levels of wintertime humidity.

Unit Combination		Power Supply				Compressor	OFM		IFM	
Indoor Unit	Outdoor Unit	Hz - Volts	Voltage Range	MCA	MOCP	RLA	W	FLA	W	FLA
FVXS09NVJU	RXL09QMVJUA	60 - 208 60 - 230	Min. 187 V Max. 253 V	9.5	15	8.5	18	0.15	12	0.21
FVXS12NVJU	RXL12QMVJU9A	60 - 208 60 - 230	Min. 187 V Max. 253 V	13	15	12	20	0.17	13	0.22
FVXS15NVJU	RXL15QMVJUA	60 - 208 60 - 230	Min. 187 V Max. 253 V	13	15	11.8	71	0.47	23	0.29

# Daikin *AURORA*

## Single Zone FDMQ Ducted Concealed Heat Pump

Up to 19.4 SEER | Up to 10.8 HSPF



### COMFORTABLE LIMITED WARRANTY\* PROTECTION

\* Complete warranty details available from your local dealer/contractor or at [www.daikincomfort.com](http://www.daikincomfort.com). To receive the 12-Year Parts Limited Warranty, online registration must be completed within 60 days of installation. Online registration is not required in California or Québec. The duration of warranty coverages in Texas differs in some cases. *If product installed in a commercial application, limited warranty period is 5 years.*

The Daikin *AURORA* FDMQ ducted concealed ceiling unit provides a completely concealed installation, minimizing the impact on decor. Easily incorporate longer duct runs and high MERV filters with available external static pressures of up to .6 in. WG (150 Pa). For all regions, the outdoor units of this Daikin *AURORA* heat pump system have been redesigned to withstand extreme weather conditions, even when it is down to -13°F WB (-25°C WB) or up to 115°F DB (46°C DB) for year round comfort.

#### Standard Features

- » Energy Efficient – Up to 19.4 SEER, up to 10.8 HSPF, up to 12.7 EER
- » Up to 95% rated cooling capacity at 104°F DB (40°C DB) and efficient operation as high as 115°F DB (46°C DB) ambient temperature
- » Up to 100% rated heating capacity at 5°F WB (-15°C WB) and efficient operation as low as -13°F WB (-25°C WB) ambient temperature
- » Cooling Range 50° - 115°F (10° - 46°C) (Extended operation to -4° - 115°F (-20° - 46°C) with facility setting and air adjustment grille)
- » Heating Range -13° - 65°F WB (-25° - 18°C WB)
- » Outdoor Sound Pressure as Low as 50 dB(A)
- » Auto Changeover
- » Auto-Fan Speed control ( with wired controller)
- » Self-Diagnostics with digital display
- » Drain Pan Inspection Port
- » Integral Lift Mechanism
- » Auto Restart After Power Failure
- » Anti-Corrosion Heat Exchanger Treatment
- » Quick Warming Function
- » Hot Start Function
- » Automatic Defrosting
- » Compatible with Daikin *One+* Smart Thermostat, DKN Cloud Wi-Fi Adaptor, or Daikin DKN Plus Interface

#### IDEAL SOLUTIONS FOR:

- » Renovations, remodeling and new construction
- » Sun rooms, basements, garages, hot or cold rooms, attics where the walls tend to be lower, or wherever wall space is at a premium
- » Ceiling void or attics which allow for a ducted solution with longer duct runs
- » Homeowners' requiring higher level of filtration
- » Homeowners' reluctance to use a visible wall or a floor mounted unit



**Daikin *AURORA* heat pump for extreme weather conditions** – Up to 100% rated heating capacity at 5°F WB (-15°C WB) and confirmed continuous operation, as low as -13°F WB (-25°C WB) ambient temperature.



**Auto-Restart** – The unit memorizes the operation mode, airflow and temperature settings. Should there be a power failure when the unit is in operation, it will automatically return to the same operating conditions when the power is restored.



**Hot Start** – (Heat Pump) When the heating operation starts or when the unit changes from cooling to heating, there is no cold draft.

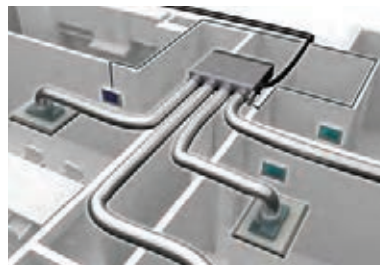

**DZK**  
DAIKIN ZONING KIT

- » Increases the flexibility of the FDMQ systems in both residential and commercial applications by adding a Zoning Box to an indoor unit fan coil
- » Allows several separate ducts to supply air to different individually-controlled zones.
- » The DZK BACnet™ Interface will work with any BACnet/IP compatible Building Management System



Wired\*  
Thermostat



Wireless\*  
Thermostat  
\*for DZK Kit



Wireless Lite\*  
Thermostat

Part Number	Optional Accessories for Indoor Unit
BRC1E73	Wired Remote Controller
BRC082A43	Wireless hand held controller (sensor included)
DACA-CP2-1	Maxi Orange Condensate Pump
AZAI6WSCDKA	DKN Cloud Wi-Fi Adaptor
DACA-CP3-1	Mini Condensate Pump
DFBS27A13	MERV 13 Filter Kit for FDMQ 12
DFBS39A13	MERV 13 Filter Kit for FDMQ 18 & 24
DTST-ONE-ADA-A	Daikin <i>One+</i> Smart Thermostat
BRC1H71W	<i>Madoka</i> Remote Controller
KRCSH2018-01	Button Sensor Kit
AZAI6WSPDKC	Daikin DKN Plus Interface
Part Number	Optional Accessories for Outdoor Unit
DACA-WB-1	Powder-Coated Wall-Mounted Bracket
KEH067A41E(A)	Drain Pan Heater (12 MBH)
KEH063A4E	Drain Pan Heater (18 & 24 MBH)
KKP937A4	Drain Plug for OD Unit
KPW937F4	Low Ambient Wind Baffle / Air Adjustment Grille (12 MBH)
KPW063B4	Low Ambient Wind Baffle / Air Adjustment Grille (18 & 24 MBH)
KKG067A41	Back protection wire net (12 MBH)
KKG063A42	Back protection wire net (18 & 24 MBH)
KPS067A41	Snow hood (intake side plate) (12 MBH)
KPS063A41	Snow hood (intake side plate) (18 & 24 MBH)
KPS067A42	Snow hood (intake rear plate) (12 MBH)
KPS063A44	Snow hood (intake rear plate) (18 & 24 MBH)
KPS067A44	Snow hood (outlet) (12 MBH)
KPS063A47	Snow hood (outlet) (18 & 24 MBH)
RAQAHG2	Rear coil guard (12)
RAQAHG1	Rear coil guard (18 & 24)

# Daikin AURORA

## Single Zone FDMQ Ducted Concealed Heat Pump

Up to 19.4 SEER | Up to 10.8 HSPF

SINGLE ZONE SYSTEMS



Our outdoor unit drain pans have up to 14 holes which allows for effective drainage of condensation. In some case, this improved drain pan design eliminates the need for drain pan heaters, resulting in higher efficiencies in low ambient temperatures.

Model	Indoor Unit		FDMQ12RVJU		FDMQ18RVJU		FDMQ24RVJU	
	Outdoor Unit		RXL12QMVJU9A		RXL18UMVJUA		RXL24UMVJUA	
			Cooling	Heating	Cooling	Heating	Cooling	Heating
Capacity Rated (Min. - Max.)		Btu/h	10,800	13,600	17,600	21,600	21,200	24,000
Moisture Removal		gal/h	N/A	—	N/A	—	N/A	—
COP Rated			3.7		3.8		3.8	
EER Rated			11.7		12.7		12.5	
SEER			18		19.4		18.6	
HSPF			10.8		10.3		10	
Piping Connections	Liquid	in. (mm)	Ø 1/4 (Ø 6.4)					
	Gas		Ø 3/8 (9.5)		Ø 1/2 (12.7)		Ø 5/8 (15.9)	
	Drain		Ø 1 (25.0)					
Max. Interunit Piping Length		ft. (m)	65-5/8 (20)		98-1/2 (30)			
Max. Interunit Height Difference			49-1/4 (15)		65-5/8 (20)			
Chargeless			32.8 (10)					
Amount of Additional Charge of Refrigerant		oz/ft. (g/m)	0.21 (20)		0.32 (30)			
Operating Range - Cooling		°F DB	50° - 115°F					
Operating Range - Low-Ambient Cooling*			5° - 115°F					
Operating Range - Cooling with Optional Air Adjustment Grille*			-4° - 115°F					
Operating Range - Heating†			-13° - 65 °F					
Indoor Unit			FDMQ12RVJU		FDMQ18RVJU		FDMQ24RVJU	
External Static Pressure		"Wg(Pa)	0.6 (150)					
Airflow Rate	H	cfm (m³/min)	392 (11.1)	392 (11.1)	675 (19.1)	675 (19.1)	798 (22.6)	798 (22.6)
	M		332 (9.4)	332 (9.4)	572 (16.2)	572 (16.2)	678 (19.2)	678 (19.2)
	L		275 (7.8)	275 (7.8)	473 (13.4)	473 (13.4)	558 (15.8)	558 (15.8)
	SL		—	—	—	—	—	—
Fan	Speed	Steps	—					
Air Filter			—					
Dimensions (H x W x D)		in. (mm)	9-5/8 x 27-9/16 x 31-1/2 (245 x 700 x 800)			9-5/8 x 39-3/8 x 31-1/2 (245 x 1,000 x 800)		
Weight		lbs. (kg)	64 (29)			82 (37)		
Sound Pressure Level (H / M / L / SL)		dB(A)	33	33	35	35	40	40
Outdoor Unit			RXL12QMVJU9A		RXL18UMVJUA		RXL24UMVJUA	
Compressor	Motor Output	W	1100		1,920			
Refrigerant	Type		R-410A					
	Charge	lbs. (kg)	2.09 (0.95)		3.53 (1.60)			
Airflow Rate	H	cfm (m³/min)	1,144 (32.4)	1,006 (28.5)	2,418 (68.5)	2,361 (66.9)	2,418 (68.5)	2,361 (66.9)
	SL		—	—	—	—	—	—
Dimensions (H x W x D)		in. (mm)	21-5/8 x 26-9/16 x 11-3/16 (550 x 675 x 284)			28-15/16 x 34-1/4 x 12-5/8 (735 x 870 x 320)		
Weight		lbs. (kg)	70 (32)			130 (59)		
Sound Pressure Level	H	dB(A)	50		54	55	55	55

\* Cutting a jumper or a dipswitch setting is required. Refer to installation manual.

† The installation of an optional drain-pan is recommended in areas where ambient temperature may fall below 5°F (-15°C) or in areas of heavy snowfall or high levels of wintertime humidity.

Unit Combination		Power Supply				Compressor	OFM		IFM	
INDOOR UNIT	OUTDOOR UNIT	Hz - Volts	VOLTAGE RANGE	MCA	MOCP	RLA	W	FLA	W	FLA
FDMQ12RVJU	RXL12QMVJU9A	60 - 208	Min. 187 V Max. 253 V	13	15	12	20	0.17	130	0.73
		60 - 230								
		60 - 240								
FDMQ18RVJU	RXL18UMVJUA	60 - 208	Min. 187 V Max. 253 V	19.5	20	18.25	76	0.47	230	1.22
		60 - 230								
		60 - 240								
FDMQ24RVJU	RXL24UMVJUA	60 - 208	Min. 187 V Max. 253 V	19.8	20	18.25	76	0.47	230	1.54
		60 - 230								
		60 - 240								

# Daikin VISTA

## Ceiling Cassette Heat Pump

Up to 20.9 SEER | Up to 11.7 HSPF

### COMFORTABLE LIMITED WARRANTY\* PROTECTION



\* Complete warranty details available from your local dealer/contractor or at [www.daikincomfort.com](http://www.daikincomfort.com). To receive the 12-Year Parts Limited Warranty, online registration must be completed within 60 days of installation. Online registration is not required in California or Québec. The duration of warranty coverages in Texas differs in some cases. *If product installed in a commercial application, limited warranty period is 5 years.*

Daikin VISTA ceiling cassette heat pumps are a remarkable blend of iconic design and engineering excellence with an elegant white or a silver and white finish. Fitting within the ceiling grid and discreetly mounted to the ceiling itself, VISTA ceiling cassette is stylish, low profile, and compact. High efficiency and comfort is delivered through the combined use of floor and presence sensors (optional). It is also possible to close individual louvers via the wired remote control for personalized comfort.

#### Standard Features

- » Seamless integration in standard architectural ceiling tiles, leaving only 5/16"
- » High efficiencies with up to 20.9 SEER and up to 11.7 HSPF
- » Cooling Range: 50° - 115°F (Extended operation to -4° - 115°F with facility setting and air adjustment grille)
- » Heating Range: 5° - 65°F
- » Energy efficient thanks to specially developed small tube heat exchanger, DC fan motor and two optional intelligent sensors
- » Remarkable blend of iconic design and engineering excellence with an elegant finish in white or a combination of silver and white
- » No optional adaptor needed for DIII-connection, link your unit into the wider building management system
- » Outside air integration possible of up to 2-3% of the nominal indoor air volume
- » 12-Year Parts Limited Warranty\*

#### Optional Features

- » Wired controller
- » Fresh air integration possible
- » Presence and Floor Sensor
- » Compatible with Daikin One+ Smart Thermostat, DKN Cloud Wi-Fi adaptor or Daikin DKN Plus Interface.

Part Number	Optional Accessories for Indoor Unit
BRYQ60A2S	Sensor kit (Silver) Intelligent Eye, and Floor Sensor
BRYQ60A2W	Sensor kit (White) Intelligent Eye, and Floor Sensor
BDBHQ44C60	Sealing member of air discharge outlet
KAF441C60	Long life filter
BYFQ60C2W1S	Low Profile Decoration Panel (Silver) - 1-13/16 x 24-7/16 x 24-7/16
AZAI6WSCDKA	DKN Cloud Wi-Fi Adaptor
BYFQ60C2W1W	Low Profile Decoration Panel (White) - 1-13/16 x 24-7/16 x 24-7/16
DTST-ONE-ADA-A	Daikin One+ Smart Thermostat
AZAI6WSPDKC	Daikin DKN Plus Interface
KRCHS2018-01	Button Sensor Kit
BRCH1H71W	Madoka Remote Controller
BRCH1E73	Navigation Remote Controller

Part Number	Optional Accessories for Outdoor Unit
DACA-WB-1	Powder-Coated Wall-Mounted Bracket
KPW937F4	Air direction adjustment grille (09 & 12)
KPW063B4	Air direction adjustment grille (15 & 18)
KEH067A41E(A)	Daikin BMS Drain Pan Heater Small (09 & 12)
KEH063A4E	Daikin BML Drain Pan Heater Large (15 & 18)
KKG067A41	Back protection wire net (09 & 12)
KKG063A42	Back protection wire net (15 & 18)
KPS067A41	Snow hood (intake side plate) (09 & 12)
KPS067A42	Snow hood (intake rear plate) (09 & 12)
KPS067A44	Snow hood (outlet) (09 & 12)
KPS063A41	Snow hood (intake side plate) (15 & 18)
KPS063A44	Snow hood (intake rear plate) (15 & 18)
KPS063A47	Snow hood (outlet) (15 & 18)
KKP937A4	Drain Plug for OD Unit
RAQAHLGD2	Rear coil guard (09 & 12)
RAQAHLGD1	Rear coil guard (15 & 18)



**Draft Reduction** – This system directs warm air to the floor in winter and cool air across the room in summer for optimal efficiency and comfort. The large flap governs airflow direction while the small flap (or diffuser) swings, producing fine air currents that help circulate the air around the room.



**Individual Louver Control** – The new louver changes the delivery angle to horizontal for cooling and vertical for heating operation, to keep cold or warm air from blowing directly onto your body.



#### Included in the optional sensor kit:

**Presence and Floor Sensor** (optional part #BRYQ60A2W or BRYQ60A2S) – The presence and floor sensors are infrared sensors with the ability to sense movement in the room. When you are in the room, the system operates normally. If you leave the room for more than 20 minutes the system automatically changes to an energy-saving operation. Using the intelligent eye, savings of up to 20% in cooling and up to 30% in heating can be achieved. The floor sensor detects the average floor temperature and ensures even temperature distribution between ceiling and floor.

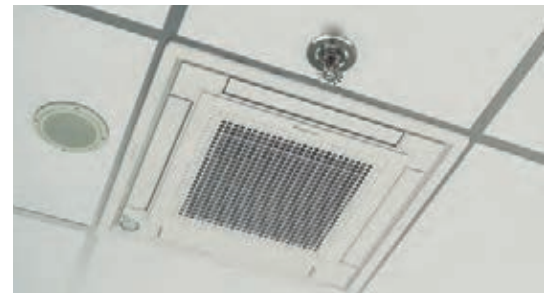

The VISTA Ceiling Cassette fits within a 2'x 2' ceiling grid and can be installed in close proximity to other building accessories.

# Daikin VISTA

## Ceiling Cassette Heat Pump

Up to 20.9 SEER | Up to 11.7 HSPF

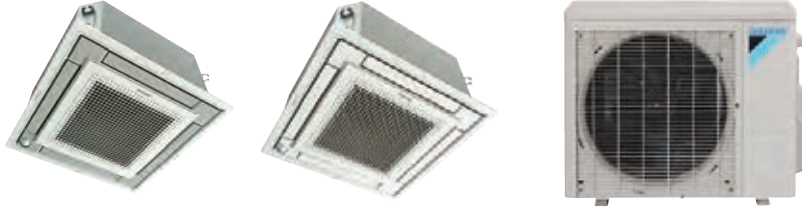

SINGLE ZONE SYSTEMS

Model	Indoor Unit		FFQ09Q2VJU		FFQ12Q2VJU		FFQ15Q2VJU		FFQ18Q2VJU	
	Outdoor Unit		RX09RMVJU9A		RX12RMVJU9A		RX15RMVJUA		RX18RMVJU9A	
			Cooling	Heating	Cooling	Heating	Cooling	Heating	Cooling	Heating
Capacity Rated (Min. ~ Max.)	Btu/h		9,100 (4,600 ~ 11,000)	10,000 (4,600 ~ 14,000)	10,800 (4,600 ~ 13,300)	13,500 (4,600 ~ 16,800)	14,400 (5,100 ~ 16,200)	16,200 (5,200 ~ 16,300)	17,400 (5,100 ~ 18,800)	21,600 (5,400 ~ 21,800)
Moisture Removal	gal/h		N/A	-	N/A	-	N/A	-	N/A	-
COP Rated			4.58		4.02		3.86		3.36	
EER Rated			13.0				12.5			
SEER			20.9		20.2		20.7		19.3	
HSPF			11.7		11.2		11.0		10.1	
Piping Connections	Liquid	in. (mm)	Ø 1/4 (Ø 6.4)							
	Gas		Ø 3/8 (Ø 9.5)				Ø 1/2 (Ø 12.7)			
	Drain		Ø1-1/32 (Ø 26.0)							
Max. Interunit Piping Length	ft. (m)		65-5/8 (20)				98-7/16 (30)			
Max. Interunit Height Difference	ft. (m)		49-1/4 (15)				65-5/8 (20)			
Chargeless			32-13/16 (10)							
Amount of Additional Charge of Refrigerant	oz/ft. (g/m)		0.21 (20)							
Operating Range - Cooling			50° - 115°F							
Operating Range - Low-Ambient Cooling*	°F DB		14° - 115°F							
Operating Range - Cooling with Optional Air Adjustment Grille*			-4° - 115°F							
Operating Range - Heating	°F WB		5° - 65°							
Indoor Unit			FFQ09Q2VJU		FFQ12Q2VJU		FFQ15Q2VJU		FFQ18Q2VJU	
Airflow Rate	H	cfm (m³/min)	378 (10.7)	399 (11.3)	406 (11.5)	427 (12.1)	420 (11.9)	441 (12.5)	448 (12.7)	498 (14.1)
	M		339 (9.6)	357 (10.1)	353 (10.0)	371 (10.5)	367 (10.4)	385 (10.9)	378 (10.7)	420 (11.9)
	L		268 (7.6)	282 (8.0)	268 (7.6)	282 (8.0)	293 (8.3)	307 (8.7)	275 (7.8)	307 (8.7)
	SL		-	-	-	-	-	-	-	-
Fan	Speed	Steps	Turbo Fan, 3 Steps, Quiet, Auto							
Air Direction Control			Right, Left, Horizontal, Downward							
Air Filter			Removable, Washable							
Dimensions (H x W x D)	in. (mm)		10-1/4 x 22-5/8 x 22-5/8 (260 x 575 x 575)							
Weight	lbs. (kg)		36 (16)				39 (17.5)			
Sound Pressure Level (H / M / L / SL)	dB(A)		38 / 35 / 29		39 / 36 / 30		40 / 37 / 31		44 / 40 / 32	
Outdoor Unit			RX09RMVJU9A		RX12RMVJU9A		RX15RMVJUA		RX18RMVJU9A	
Compressor	Motor Output	W	790				1,100		1,100	
Refrigerant	Type	R-410A								
	Charge	lbs. (kg)	2.09 (0.95)				2.49 (1.13)			
Airflow Rate	H	cfm (m³/min)	985 (27.9)	1,105 (31.3)	1,105 (31.3)	1,105 (31.3)	2,314 (65.53)	2,108 (59.7)	2,461 (69.7)	2,553 (72.3)
Dimensions (H x W x D)	in. (mm)		21-5/8 x 26-9/16 x 11-3/16 (550 x 675 x 284)				28-15/16 x 34-1/4 x 12-5/8 (735 x 870 x 320)			
Weight	lbs. (kg)		60 (27)				97 (44)			
Sound Pressure Level	H	dB(A)	46	50	49	51	50	51	54	55

\* Cutting a jumper or a dipswitch setting is required. Refer to installation manual.

Unit Combination		Power Supply				Compressor		OFM		IFM	
INDOOR UNIT	OUTDOOR UNIT	Hz - VOLTS	VOLTAGE RANGE	MCA	MOCP	RLA	W	FLA	W	FLA	
FFQ09Q2VJU	RX09RMVJU9A	60 - 208	Min. 187 V Max. 253 V	9.0	15	7.5	39	0.13	50	0.28	
		60 - 230									
		60 - 208									
FFQ12Q2VJU	RX12RMVJU9A	60 - 208	Min. 187 V Max. 253 V	9.1	15	7.5	39	0.13	50	0.28	
		60 - 230									
		60 - 208									
FFQ15Q2VJU	RX15RMVJUA	60 - 208	Min. 187 V Max. 253 V	9.7	15	8.0	91	0.31	50	0.28	
		60 - 230									
		60 - 208									
FFQ18Q2VJU	RX18RMVJU9A	60 - 208	Min. 187 V Max. 253 V	12.8	15	10.75	110	0.38	50	0.28	
		60 - 230									
		60 - 208									



# Daikin LV series

## Wall-Mounted Heat Pump

Up to 24.5 SEER | Up to 12.5 HSPF

COMFORTABLE LIMITED WARRANTY\* PROTECTION



\* Complete warranty details available from your local dealer/contractor or at [www.daikincomfort.com](http://www.daikincomfort.com). To receive the 12-Year Parts Limited Warranty, online registration must be completed within 60 days of installation. Online registration is not required in California or Québec. The duration of warranty coverages in Texas differs in some cases. *If product installed in a commercial application, limited warranty period is 5 years.*

LV series is a feature-packed, intelligent wall-mounted system that includes intelligent eye for energy savings and horizontal auto swing outlet fins for 3-D airflow comfort. With up to 24.5 SEER level.

### Standard Features

- » Energy Efficient – Up to 24.5 SEER, 12.5 HSPF, up to 15.3 EER – Variable-Speed, Inverter, Compressor
- » Cooling Range: 50° - 115°F (Extended operation to 0° - 115°F with facility setting and air adjustment grille)
- » Heating Range: 5° - 65°F
- » Indoor Sound Pressure as Low as 22\* dB(A)
- » Outdoor Sound Pressure as Low as 43 dB(A)
- » Intelligent Eye
- » Power airflow dual flaps and 3-D Airflow
- » Titanium Apatite Photocatalytic Air Purifying Filter
- » Weekly timer
- » Program Dry Function
- » Econo Mode
- » Powerful Operation Mode
- » Backlit Wireless Remote Controller
- » Auto-Changeover
- » Auto-Fan Speed Control
- » Self Diagnostics with Digital Display
- » Auto-Restart After Power Failure
- » Anti-Corrosion Heat Exchanger Treatment
- » Quick Warming Function
- » Hot Start Function
- » Automatic Defrosting  
\*On SL fan speed

### Optional Features

- » Wired controller
- » Compatible with Daikin *One+* Smart Thermostat, DKN Residential Cloud Wi-Fi Adaptor, or DKN Plus Interface

Part Number	Optional Accessories for Indoor Unit
BRC944B2-A08	Wired Remote Controller
BRCW901A08	Wired Remote Controller Cord - 8m
DACA-BRCW901P10	Remote Controller Cable, Plenum Rated, 10 ft
DACA-BRCW901P25	Remote Controller Cable, Plenum Rated, 25 ft
DACA-ARCW901P10	IR Receiver Cable, Plenum Rated, 10ft
DACA-ARCW901P25	IR Receiver Cable, Plenum Rated, 25ft
DACA-CP3-1	Condensate Pump (Fits inside all Daikin indoor unit heads)
DTST-ONE-ADA-A	Daikin <i>One+</i> Smart Thermostat
AZA16WSCDKB	DKN Residential Cloud Wi-Fi Adaptor
AZA16WSPDKC	Daikin DKN Plus Interface
Part Number	Optional Accessories for Outdoor Unit
DACA-WB-3	Powder Coated Wall-Mounted Bracket
KEH041A41	Drain Pan Heater (09x12)
KEH041A42	Drain Pan Heater (15x18)
KEH041A43	Drain Pan Heater (24)
KKP937A4	Drain Plug (9, 12, 15, 18)
KKP945A4	Drain Plug (24)
KPW937F4	Air Direction Adjustment Grille (09, 12)
KPW945B4	Air Direction Adjustment Grille (15, 18, 24)
RAQAHLGD3	Rear coil guard (09 & 12)
RAQAHLGD4	Rear coil guard (15 & 18)
RAQAHLGD5	Rear coil guard (24)

### IDEAL SOLUTIONS FOR:

- » Renovations, remodeling and new construction
- » Sun rooms, basements, garages, hot or cold rooms, attics where the walls tend to be lower, or wherever wall space is at a premium
- » Ceiling void or attic does not allow for a viable duct run option
- » Homeowners desiring advanced features for comfort and savings



**3-D Airflow** – Combines vertical and horizontal auto-swing to circulate cool/warm air to the corners of large spaces.



**Intelligent Eye** – The intelligent eye is an infrared sensor with the ability to sense movement in the room. When you are in the room, the air conditioner operates normally. If you leave the room for more than 20 minutes the air conditioner automatically changes to an energy-saving operation. Using the intelligent eye, savings of up to 20% in cooling and up to 30% in heating can be achieved compared to units without this feature.



**Auto-Restart** – The unit memorizes the operation mode, airflow and temperature settings. Should there be a power failure when the unit is in operation, it will automatically return to the same operating conditions when the power is restored.



**Titanium Apatite Photocatalytic Air Purifying Filter** – This filter combines the air-purifying filter and titanium apatite photocatalytic deodorizing filter in a single highly effective unit.



**Hot Start** – (Heat Pump) When the heating operation starts or when the unit changes from cooling to heating, there is no cold draft.



**Powerful Operation Mode** – Pushing the POWERFUL button on the remote control gives you a boost in cooling or heating power for a 20-minute period, even if the unit is already operating at high capacity.





# Daikin LV series

## Wall-Mounted Heat Pump

Up to 24.5 SEER | Up to 12.5 HSPF

SINGLE ZONE SYSTEMS



Model	Indoor Unit		FTXS09LVJU		FTXS12LVJU		FTXS15LVJU		FTXS18LVJU		FTXS24LVJU	
	Outdoor Unit		RXS09LVJU		RXS12LVJU		RXS15LVJU		RXS18LVJU		RXS24LVJU	
			Cooling	Heating	Cooling	Heating	Cooling	Heating	Cooling	Heating	Cooling	Heating
Capacity Rated (Min. ~ Max.)	Btu/h		9,000 (4,400 ~ 9,000)	12,000 (4,400 ~ 12,000)	12,000 (4,800 ~ 12,000)	14,400 (4,800 ~ 14,400)	15,000 (5,800 ~ 15,000)	18,000 (5,800 ~ 18,000)	18,000 (5,800 ~ 18,000)	21,600 (5,800 ~ 21,600)	21,500 (7,800 ~ 21,500)	25,400 (7,800 ~ 25,400)
Moisture Removal	gal/h		0.3	—	0.5	—	0.8	—	1	—	1.2	—
COP Rated			4.46		4.35		4.00		3.70		3.37	
EER Rated			15.3		12.8		14.4		12.7		12.5	
SEER			24.5		23.0		20.6		20.3		20.0	
HSPF			12.5		12.5		11.6		11.0		10.6	
Piping Connections	Liquid	in. (mm)	Ø 1/4 (6.4)				Ø 1/2 (12.7)				Ø 5/8 (15.9)	
	Gas		Ø 3/8 (9.5)				Ø 5/8 (16.0)					
	Drain											
Max. Interunit Piping Length	ft. (m)		65.6 (20)				98.4 (30)					
Max. Interunit Height Difference Chargeless			49.2 (15)				65.6 (20)					
Amount of Additional Charge of Refrigerant	oz/ft. (g/m)						32.8 (10)					
Operating Range Cooling							50 - 115°F					
Operating Range - Low-Ambient Cooling*	°F DB						14° - 115°F					
Operating Range - Cooling with Optional Air Adjustment Grille*							0° - 115°F					
Operating Range - Heating	°F WB						5° - 65°F					
<b>Indoor Unit</b>			<b>FTXS09LVJU</b>		<b>FTXS12LVJU</b>		<b>FTXS15LVJU</b>		<b>FTXS18LVJU</b>		<b>FTXS24LVJU</b>	
Airflow Rate	H	cfm (m³/min)	381 (10.8)	420 (11.9)	403 (11.4)	438 (12.4)	568 (16.1)	593 (16.8)	583 (16.5)	625 (17.7)	643 (18.2)	699 (19.8)
	M		279 (7.9)	321 (9.1)	307 (8.7)	335 (9.5)	477 (13.5)	505 (14.3)	484 (13.7)	526 (14.9)	494 (14.0)	572 (16.2)
	L		194 (5.5)	233 (6.6)	205 (5.8)	240 (6.8)	385 (10.9)	417 (11.8)	385 (10.9)	431 (12.2)	350 (9.9)	445 (12.6)
	SL		145 (4.1)	219 (6.2)	155 (4.4)	212 (6.0)	360 (10.2)	371 (10.5)	360 (10.2)	399 (11.3)	328 (9.3)	403 (11.4)
Fan	Speed	Steps	5 Steps, Quiet, Auto									
Air Direction Control			Right, Left, Horizontal, Downward									
Air Filter			Removable / Washable									
Dimensions (H x W x D)	in. (mm)		11-5/8 x 31-1/2 x 8-7/16 (295 x 800 x 215)				13-3/8 x 41-5/16 x 9-3/4 (340 x 1,050 x 248)					
Weight	lbs. (kg)		20 (9)		22 (10)		31 (14)					
Sound Pressure Level (H / M / L / S)	dB(A)		41 / 33 / 25 / 22	42 / 35 / 28 / 25	45 / 37 / 29 / 23	45 / 39 / 29 / 26	45 / 40 / 35 / 32	43 / 38 / 33 / 30	46 / 41 / 36 / 33	45 / 40 / 35 / 32	51 / 44 / 37 / 34	48 / 42 / 37 / 34
<b>Outdoor Unit</b>			<b>RXS09LVJU</b>		<b>RXS12LVJU</b>		<b>RXS15LVJU</b>		<b>RXS18LVJU</b>		<b>RXS24LVJU</b>	
Compressor	Motor Output	W	600				1,100				1,920	
Refrigerant	Type	R-410A										
	Charge	lbs. (kg)	2.43 (1.1)		2.65 (1.2)		3.97 (1.8)		5.07 (2.3)			
Airflow Rate	H	cfm	1,102 (31.2)	992 (28.1)	1,183 (33.5)	992 (28.1)	1,713 (48.5)	1,405 (39.8)	1,780 (50.4)	1,444 (40.9)	1,924 (54.5)	1,854 (52.5)
	L	(m³/min)	989 (28.0)	840 (23.8)	989 (28.0)	840 (23.8)	1,469 (41.6)	1,306 (37.0)	1,494 (42.3)	1,328 (37.6)	1,624 (46.0)	1,624 (46.0)
	SL											
Dimensions (H x W x D)	in. (mm)		21-5/8 x 30-1/8 x 11-1/4 (550 x 765 x 285)				28-15/16 x 32-1/2 x 11-13/16 (735 x 825 x 300)				30-5/16 x 35-7/16 x 12-5/8 (770 x 900 x 320)	
Weight	lbs. (kg)		75 (34)				104 (47)				159 (72)	
Sound Pressure Level	H/L	dB(A)	47 / 43	48 / 44	49 / 44	49 / 45	47 / 44	48 / 45	49 / 46	49 / 46	52 / 49	52 / 49

\* Cutting a jumper or a dipswitch setting is required. Refer to installation manual.

Unit Combination		Power Supply				Compressor		OFM		IFM	
INDOOR UNIT	OUTDOOR UNIT	Hz - Volts	Voltage Range	MCA	MOCP	RLA	W	FLA	W	FLA	
FTXS09LVJU	RXS09LVJU	60 - 208	Min. 187 V Max. 253 V	8.00	15	3.2	23	0.22	23	0.15	
		60 - 230				2.9					
FTXS12LVJU	RXS12LVJU	60 - 208	Min. 187 V Max. 253 V	8.75	15	4.4	23	0.22	23	0.15	
		60 - 230				3.9					
FTXS15LVJU	RXS15LVJU	60 - 208	Min. 187 V Max. 253 V	13.75	20	4.7	53	0.32	48	0.31	
		60 - 230				4.2					
FTXS18LVJU	RXS18LVJU	60 - 208	Min. 187 V Max. 253 V	13.75	20	6.6	53	0.32	48	0.32	
		60 - 230				5.9					
FTXS24LVJU	RXS24LVJU	60 - 208	Min. 187 V Max. 253 V	17.50	20	7.9	66	0.40	48	0.57	
		60 - 230				7.1					

# Daikin LV series

## Slim-Duct Concealed Ceiling Units

Up to 15.5 SEER | Up to 10.4 HSPF

COMFORTABLE LIMITED WARRANTY\* PROTECTION



\* Complete warranty details available from your local dealer/contractor or at [www.daikincomfort.com](http://www.daikincomfort.com). To receive the 12-Year Parts Limited Warranty, online registration must be completed within 60 days of installation. Online registration is not required in California or Québec. The duration of warranty coverages in Texas differs in some cases. *If product installed in a commercial application, limited warranty period is 5 years.*

LV series is offered in a slim-ducted concealed ceiling unit providing an extremely unobtrusive, compact solution, where only the discharge and intake grilles are visible. In addition, they free up the maximum amount of floor and wall space to minimize the impact on decor. Also, their new low consumption DC fan motor offers energy saving.

### Standard Features

- » Energy Efficient – Up to 15.5 SEER, 10.4 HSPF, up to 11.2 EER – Variable-Speed, Inverter, Compressor
- » Cooling Range: 50° - 115°F (Extended operation to 0° - 115°F with facility setting and air adjustment grille)
- » Heating Range: 5° - 65°F
- » Indoor Sound Pressure as Low as 31 dB(A)
- » Outdoor Sound Pressure as Low as 43 dB(A)
- » Program Dry Function
- » Econo Mode
- » Powerful Operation Mode
- » Backlit Wireless Remote Controller
- » Auto-Changeover
- » Auto-Fan Speed Control
- » Self Diagnostics with Digital Display
- » Auto Restart After Power Failure
- » Anti-Corrosion Heat Exchanger Treatment
- » Quick Warming Function
- » Hot Start Function
- » Automatic Defrosting

### Optional Features

- » Wired controller
- » Compatible with Daikin *One+* Smart Thermostat, DKN Residential Cloud Wi-Fi Adaptor, or DKN Plus Interface

Part Number	Optional Accessories for Indoor Unit
BRC944B2-A08	Wired Remote Controller
BRCW901A08	Wired Remote Controller Cord - 8m
DACA-BRCW901P10	Remote Controller Cable, Plenum Rated, 10 ft
DACA-BRCW901P25	Remote Controller Cable, Plenum Rated, 25 ft
DACA-ARCW901P10	IR Receiver Cable, Plenum Rated, 10ft
DACA-ARCW901P25	IR Receiver Cable, Plenum Rated, 25ft
DACA-CP3-1	Condensate Pump (Fits inside all Daikin indoor unit heads)
DTST-ONE-ADA-A	Daikin <i>One+</i> Smart Thermostat
AZAI6WSCDKB	DKN Residential Cloud Wi-Fi Adaptor
AZAI6WSPDKC	Daikin DKN Plus Interface
Part Number	Optional Accessories for Outdoor Unit
DACA-WB-3	Powder Coated Wall-Mounted Bracket
KEH041A41	Drain Pan Heater (09x12)
KKP937A4	Drain Plug
KPW937F4	Air Adjustment grille (09x12)
RAQAHLGD3	Rear coil guard (09 & 12)

### IDEAL SOLUTIONS FOR:

- › Renovations, remodeling and new construction
- › Sun rooms, basements, garages, hot or cold rooms, attics where the walls tend to be lower, or wherever wall space is at a premium
- › Ceiling void or attic does not allow for a viable standard ducted solution
- › Homeowners' reluctance to use a visible wall or a floor mounted unit



**Auto-Restart** – The unit memorizes the operation mode, airflow and temperature settings. Should there be a power failure when the unit is in operation, it will automatically return to the same operating conditions when the power is restored.



**Hot Start** – (Heat Pump) When the heating operation starts or when the unit changes from cooling to heating, there is no cold draft.



**Powerful Operation Mode** – Pushing the POWERFUL button on the remote control gives you a boost in cooling or heating power for a 20-minute period, even if the unit is already operating at high capacity.

# Daikin LV series

## Slim-Duct Concealed Ceiling Units

Up to 15.5 SEER | Up to 10.4 HSPF

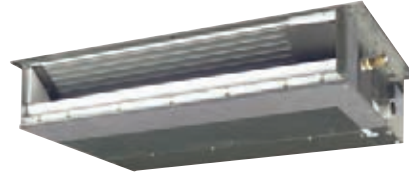

SINGLE ZONE SYSTEMS

Model	Indoor Unit		FDXS09LVJU RXS09LVJU		FDXS12LVJU RXS12LVJU	
	Outdoor Unit		Cooling	Heating	Cooling	Heating
Capacity Rated (Min.-Max.)		Btu/h	8,500 (4,400 ~ 8,500)	10,000 (4,400 ~ 10,000)	11,500 (4,800 ~ 11,500)	11,500 (4,800 ~ 11,500)
Moisture Removal		gal/h	2.5	—	4.0	—
COP Rated			3.45		3.51	
EER Rated			11.2		9.1	
SEER			15.1		15.5	
HSPF			10.3		10.4	
Piping Connections	Liquid	in. (mm)	Ø 1/4 (6.4)			
	Gas		Ø 3/8 (9.5)			
	Drain		Ø 25/32 (20.0)			
Max. Interunit Piping Length		ft. (m)	65.6 (20)			
Max. Interunit Height Difference			49.2 (15)			
Chargeless			32.8 (10)			
Amount of Additional Charge of Refrigerant		oz/ft. (g/m)	0.21 (20)			
Operating Range - Cooling		°F DB	50 - 115°F			
Operating Range - Low-Ambient Cooling*			14° - 115°F			
Operating Range - Cooling with Optional Air Adjustment Grille*			0° - 115°F			
Operating Range - Heating		°F WB	5° - 65°F			
<b>Indoor Unit</b>			<b>FDXS09LVJU</b>		<b>FDXS12LVJU</b>	
External Static Pressure		"Wg (Pa)	0.12 (30)			
Airflow Rate	H	cfm (m³/min)	305 (8.6)			
	M		280 (7.9)			
	L		260 (7.4)			
	SL		235 (6.7)			
Fan	Speed	Steps	5 Steps, Quiet, Auto			
Air Filter			Removable / Washable			
Dimensions (H × W × D)		in. (mm)	7-7/8 × 27-9/16 × 24-7/16 (200 × 700 × 620)			
Weight		lbs. (kg)	47 (21)			
Sound Pressure Level (H / M / L)		dB(A)	35 / 33 / 31			
<b>Outdoor Unit</b>			<b>RXS09LVJU</b>		<b>RXS12LVJU</b>	
Compressor	Motor Output	W	600			
Refrigerant	Type		R-410A			
	Charge	lbs. (kg)	2.43 (1.1)		2.65 (1.2)	
Airflow Rate	H	cfm (m³/min)	1,102 (31.2)		1,183 (33.5)	
	L		989 (28.0)	840 (23.8)	989 (28.0)	840 (23.8)
Dimensions (H × W × D)		in. (mm)	21-5/8 × 30-1/8 × 11-1/4 (550 × 765 × 285)			
Weight		lbs. (kg)	75 (34)			
Sound Pressure Level (H / L)		dB(A)	47 / 43	48 / 44	49 / 44	49 / 45

\* Cutting a jumper or a dipswitch setting is required. Refer to installation manual.

Unit Combination		Power Supply				Compressor		OFM		IFM	
INDOOR UNIT	OUTDOOR UNIT	Hz - Volts	Voltage Range	MCA	MOCP	RLA	W	FLA	W	FLA	
FDXS09LVJU	RXS09LVJU	60 - 208	Min. 187 V Max. 253 V	8.00	15	4.1	23	0.22	62	0.52	
		60 - 230				3.7					
FDXS12LVJU	RXS12LVJU	60 - 208	Min. 187 V Max. 253 V	8.75	15	5.9	23	0.22	62	0.52	
		60 - 230				5.3					

# Daikin FDMQ

## Ducted Concealed Indoor Unit

Up to 20.2 SEER | Up to 10.6 HSPF

### COMFORTABLE LIMITED WARRANTY\* PROTECTION



\* Complete warranty details available from your local dealer/contractor or at [www.daikincomfort.com](http://www.daikincomfort.com). To receive the 12-Year Parts Limited Warranty, online registration must be completed within 60 days of installation. Online registration is not required in California or Québec. The duration of warranty coverages in Texas differs in some cases. If product installed in a commercial application, limited warranty period is 5 years.

A ducted concealed ceiling unit provides a completely concealed installation, minimizing the impact on decor. Easily incorporate longer duct runs and high MERV filters with available external static pressures of up to 0.6.

#### Standard Features

- » Energy Efficient – Up to 20.2 SEER, up to 10.6 HSPF, up to 12.7 EER – Variable-Speed, Inverter, Compressor
- » Cooling Range 50° - 115°F (Extended operation to -4° - 115°F with facility setting and air adjustment grille)
- » Heating Range 5° - 65°F
- » Indoor Sound Pressure as low as 32 dB(A)
- » Outdoor Sound Pressure as Low as 46 dB(A)
- » Auto Changeover
- » Auto-Fan Speed control ( with wired controller)
- » Self-Diagnostics with digital display
- » Drain Pan Inspection Port
- » Integral Lift Mechanism
- » Auto Restart After Power Failure
- » Anti-Corrosion Heat Exchanger Treatment
- » Quick Warming Function
- » Hot Start Function
- » Automatic Defrosting
- » Compatible with Daikin *One+* Smart Thermostat, DKN Cloud Wi-Fi Adaptor, or Daikin DKN Plus Interface

#### IDEAL SOLUTIONS FOR:

- » Renovations, remodeling and new construction
- » Sun rooms, basements, garages, hot or cold rooms, attics where the walls tend to be lower, or wherever wall space is at a premium
- » Ceiling void or attics which allow for a ducted solution with longer duct runs
- » Homeowners' requiring higher level of filtration
- » Homeowners' reluctance to use a visible wall or a floor mounted unit



**Auto-Restart** – The unit memorizes the operation mode, airflow and temperature settings. Should there be a power failure when the unit is in operation, it will automatically return to the same operating conditions when the power is restored.



**Hot Start** – (Heat Pump) When the heating operation starts or when the unit changes from cooling to heating, there is no cold draft.

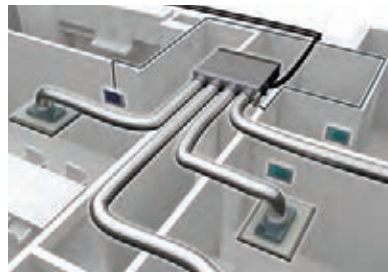

**DZK**  
DAIKIN ZONING KIT

- » Increases the flexibility of the FDMQ systems in both residential and commercial applications by adding a Zoning Box to an indoor unit fan coil
- » Allows several separate ducts to supply air to different individually-controlled zones.
- » The DZK BACnet™ Interface will work with any BACnet/IP compatible Building Management System

Part Number	Optional Accessories for Indoor Unit
BRC1E73	Wired Remote Controller
BRC082A43	Wireless hand held controller (sensor included)
DACA-CP2-1	Maxi Orange Condensate Pump
AZAI6WSCDKA	DKN Cloud Wi-Fi Adaptor
DACA-CP3-1	Mini Condensate Pump
DFBS27A13	MERV 13 Filter Kit for FDMQ 09 & 12
DFBS39A13	MERV 13 Filter Kit for FDMQ 15, 18 & 24
DTST-ONE-ADA-A	Daikin <i>One+</i> Smart Thermostat
AZAI6WSPDKC	Daikin DKN Plus Interface
KRCHS2018-01	Button Sensor Kit
BRC1H71W	<i>Madoka</i> Remote Controller
Part Number	Optional Accessories for Outdoor Unit
DACA-WB-1	Powder-Coated Wall-Mounted Bracket
KEH067A41E(A)	Drain Pan Heater (09/12 MBH)
KEH063A4E	Drain Pan Heater (15/18/24 MBH)
KKP937A4	Drain Plug for OD Unit
KPW937F4	Low Ambient Wind Baffle / Air Adjustment Grille (09/12 MBH)
KPW063B4	Low Ambient Wind Baffle / Air Adjustment Grille (15/18 / 24 MBH)
KKG067A41	Back protection wire net (09/12 MBH)
KKG063A42	Back protection wire net (15/18/24 MBH)
KPS067A41	Snow hood (intake side plate) (09/12 MBH)
KPS063A41	Snow hood (intake side plate) (15/18/24 MBH)
KPS067A42	Snow hood (intake rear plate) (09/12 MBH)
KPS063A44	Snow hood (intake rear plate) (15/18/24 MBH)
KPS067A44	Snow hood (outlet) (09/12 MBH)
KPS063A47	Snow hood (outlet) (15/18/24 MBH)
RAQAHLGD2	Rear coil guard (09 & 12)
RAQAHLGD1	Rear coil guard (15, 18 & 24)



Wired\*  
Thermostat



Wireless\*  
Thermostat



Wireless Lite\*  
Thermostat

\*for DZK Kit

# Daikin FDMQ

## Ducted Concealed Indoor Unit

Up to 20.2 SEER | Up to 10.6 HSPF



SINGLE ZONE SYSTEMS

Model	Indoor Unit		FDMQ09RVJU		FDMQ12RVJU		FDMQ15RVJU		FDMQ18RVJU		FDMQ24RVJU	
	Outdoor Unit		RX09RMVJU9A		RX12RMVJU9A		RX15RMVJUA		RX18RMVJU9A		RX24RMVJUA	
			Cooling	Heating	Cooling	Heating	Cooling	Heating	Cooling	Heating	Cooling	Heating
Capacity Rated	Btu/h		9,000	10,900	10,800	13,600	14,400	18,000	17,600	21,600	21,800	24,000
Moisture Removal	gal/h		N/A	-	N/A	-	N/A	-	N/A	-	N/A	-
COP Rated			4.1		3.7		3.8		3.8		3.8	
EER Rated			11.1		11.6		12.7		12.5			
SEER			17.8		19.4		20.2		18.5		18.6	
HSPF			10.3				10.6		10.3		10	
Piping Connections	Liquid	in. (mm)					Ø 1/4 (Ø 6.4)					
	Gas		Ø 3/8 (Ø 9.5)				Ø 1/2 (Ø 12.7)				Ø 5/8 (15.9)	
	Drain						Ø 1 (25.0)					
Max. Interunit Piping Length	ft. (m)		65.6 (20)								98.4 (30)	
Max. Interunit Height Difference Chargeless			49.2 (15)								65.6 (20)	
Amount of Additional Charge of Refrigerant	oz/ft. (g/m)						32.8 (10)					
Operating Range - Cooling	°F DB						50 - 115°F					
Operating Range - Low-Ambient Cooling*							14° - 115°F					
Operating Range - Cooling with Optional Air Adjustment Grille*							-4° - 115°F					
Operating Range - Heating	°F WB						5° - 65°F					
Indoor Unit			FDMQ09RVJU		FDMQ12RVJU		FDMQ15RVJU		FDMQ18RVJU		FDMQ24RVJU	
External Static Pressure	"Wg(Pa)						0.6 (150)					
Airflow Rate	H	cfm (m³/min)	343 (9.7)	343 (9.7)	392 (11.1)	392 (11.1)	516 (14.6)	516 (14.6)	675 (19.1)	675 (19.1)	798 (22.6)	798 (22.6)
	M		290 (8.2)	290 (8.2)	332 (9.4)	332 (9.4)	438 (12.4)	438 (12.4)	572 (16.2)	572 (16.2)	678 (19.2)	678 (19.2)
	L		240 (6.8)	240 (6.8)	275 (7.8)	275 (7.8)	360 (10.2)	360 (10.2)	473 (13.4)	473 (13.4)	558 (15.8)	558 (15.8)
	SL		-	-	-	-	-	-	-	-	-	-
Fan	Speed	Steps										
Air Filter												
Dimensions (H x W x D)	in. (mm)		9-5/8 x 27-9/16 x 31-1/2 (245 x 700 x 800)				9-5/8 x 39-3/8 x 31-1/2 (245 x 1,000 x 800)					
Weight	lbs. (kg)		64 (29)				77 (35)				82 (37)	
Sound Pressure Level	dB(A)		32	32	33	33	34	34	35	35	40	40
Outdoor Unit			RX09RMVJU9A		RX12RMVJU9A		RX15RMVJUA		RX18RMVJU9A		RX24RMVJUA	
Compressor	Motor Output	W	790				1,100					
Refrigerant	Type					R-410A						
	Charge	lbs. (kg)	2.09 (0.95)				2.49 (1.13)				3.20 (1.45)	
Airflow Rate	H	cfm (m³/min)	985 (27.9)	1,105 (31.3)	1,105 (31.3)	1,105 (31.3)	2,313 (65.5)	2,108 (59.7)	2,461 (69.7)	2,553 (72.3)	2,642 (74.8)	2,642 (74.8)
Dimensions (H x W x D)	in. (mm)		21-5/8 x 26-9/16 x 11-3/16 (550 x 675 x 284)				28-15/16 x 34-1/4 x 12-5/8 (735 x 870 x 320)					
Weight	lbs. (kg)		60 (27)				97 (44)				108 (49)	
Sound Pressure Level	H	dB(A)	46	50	49	51	50	51	54	55	56	58

\* Cutting a jumper or a dipswitch setting is required. Refer to installation manual.

Unit Combination		Power Supply				Compressor	OFM		IFM	
INDOOR UNIT	OUTDOOR UNIT	Hz - VOLTS	VOLTAGE RANGE	MCA	MOCP	RLA	W	FLA	W	FLA
FDMQ09RVJU	RX09RMVJU9A	60 - 208	Min. 187 V Max. 253 V	9	15	7.5	39	0.13	130	0.63
		60 - 230								
		60 - 208								
FDMQ12RVJU	RX12RMVJU9A	60 - 208	Min. 187 V Max. 253 V	9.1	15	7.5	39	0.13	130	0.73
		60 - 230								
		60 - 208								
FDMQ15RVJU	RX15RMVJUA	60 - 208	Min. 187 V Max. 253 V	9.7	15	8	91	0.31	230	0.87
		60 - 230								
		60 - 208								
FDMQ18RVJU	RX18RMVJU9A	60 - 208	Min. 187 V Max. 253 V	12.8	15	10.75	110	0.38	230	1.22
		60 - 230								
		60 - 208								
FDMQ24RVJU	RX24RMVJUA	60 - 208	Min. 187 V Max. 253 V	16.9	20	14.5	125	0.43	230	1.54
		60 - 230								
		60 - 208								



## Daikin NV series

# Wall-Mounted Heat Pump & Cooling Only

Up to 17.5 SEER  
Up to 9.3 HSPF | Up to 9.85 EER

COMFORTABLE LIMITED WARRANTY\* PROTECTION



\* Complete warranty details available from your local dealer/contractor or at [www.daikincomfort.com](http://www.daikincomfort.com). Warranty registration not required to receive the 10-Year Parts Limited Warranty for residential or commercial installations.. The duration of warranty coverages in Texas differs in some cases.

Daikin NV series is available in both cooling only and heat pump configurations. This feature-packed wall-mount unit offers extended capacity in an elegant design. Comfort Airflow, 3-D Air-flow and Wide Angle Louvers are just a few of the features used in the new NV series to improve comfort in a room.

### Standard Features

- » Energy Efficient – Up to 17.5 SEER, 9.3 HSPF, up to 9.85 EER – Variable-Speed, Inverter, Compressor
- » Cooling Range: 50° - 115°F (Extended operation to -22° - -115°F with facility setting and air adjustment grille)
- » Heating Range: 5° - 65°F
- » Indoor Sound Pressure as Low as 35 dB(A)
- » Outdoor Sound Pressure as Low as 56 dB(A)
- » Intelligent Eye
- » Power airflow dual flaps and 3-D Airflow
- » Titanium Apatite Photocatalytic Air Purifying Filter
- » Weekly timer
- » Program Dry Function
- » Econo Mode
- » Powerful Operation Mode
- » Backlit Wireless Remote Controller
- » Auto-Changeover
- » Auto-Fan Speed Control
- » Self Diagnostics with Digital Display
- » Auto-Restart After Power Failure
- » Anti-Corrosion Heat Exchanger Treatment
- » Quick Warming Function
- » Hot Start Function
- » Automatic Defrosting
- » Compatible with Daikin *One+* Smart Thermostat, DKN Residential Cloud Wi-Fi Adaptor, or DKN Plus Interface

Part Number	Optional Accessories for Indoor Unit
BRC944B2-A08	Wired Remote Controller (Requires 1 cord below)
BRCW901A03	Wired Remote Controller Cord (Shielded wire) 9.8 ft
BRCW901A08	Wired Remote Controller Cord (Shielded wire) 26.3 ft
KAF970A48	Titanium Apatite Deodorizing Filter (Without frame) Standard
KKF910AA4	Remote Controller Loss Prevention with Chain
DTST-ONE-ADA-A	Daikin <i>One+</i> Smart Thermostat
AZAI6WSCDKB	DKN Residential Cloud Wi-Fi Adaptor
AZAI6WSPDKC	Daikin DKN Plus Interface
Part Number	Optional Accessories for Outdoor Unit
KPW063B4	Air Direction Adjustment Grille
KKG063A42	Back Protection Wire Net
KKP937A4	Drain Plug - Standard
KEH063A4E	Drain Pan Heater
KPS063A41	Snow Hood (Intake side panel)
KPS063A44	Snow Hood (Intake side panel)
KPS063A47	Snow Hood (Outlet)
RAQAHLGD1	Rear coil guard

### IDEAL SOLUTIONS FOR:

- » Renovations, remodeling and new construction
- » Sun rooms, basements, garages, hot or cold rooms, attics where the walls tend to be lower, or wherever wall space is at a premium
- » Ceiling void or attic does not allow for a viable duct run option
- » Homeowners desiring advanced features for comfort and savings



**Low Ambient Cooling** – System is able to operate in cooling mode below 0°F (-17.7°C) outside temperature with field settings and/or optional accessories.



**3-D Airflow** – Combines vertical and horizontal auto-swing to circulate cool/warm air to the corners of large spaces.



**Intelligent Eye** – The intelligent eye is an infrared sensor with the ability to sense movement in the room. When you are in the room, the air conditioner operates normally. If you leave the room for more than 20 minutes the air conditioner automatically changes to an energy-saving operation. Using the intelligent eye, savings of up to 20% in cooling and up to 30% in heating can be achieved compared to units without this feature.



**Auto-Restart** – The unit memorizes the operation mode, airflow and temperature settings. Should there be a power failure when the unit is in operation, it will automatically return to the same operating conditions when the power is restored.



**Titanium Apatite Photocatalytic Air Purifying Filter** – This filter combines the air-purifying filter and titanium apatite photocatalytic deodorizing filter in a single highly effective unit.



**Hot Start** – (Heat Pump) When the heating operation starts or when the unit changes from cooling to heating, there is no cold draft.



# Daikin NV series

## Wall-Mounted Cooling Only

Up to 17.5 SEER | Up to 9.85 EER

SINGLE ZONE SYSTEMS

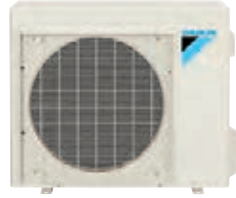

Model	Indoor Unit		FTX30NVJU		FTX36NVJU	
	Outdoor Unit		RK30NMVJUA		RK36NMVJUA	
Capacity Rated (Min. ~ Max.)	Btu/h		31,400 (10,200 ~ 31,400)		34,400 (10,200 ~ 34,400)	
Moisture Removal	gal/h		N/A		N/A	
EER Rated			9.85		9.1	
SEER			17.5		15.9	
Piping Connections	Liquid	in. (mm)	Ø 1/4 (Ø 6.4)			
	Gas		Ø 5/8 (Ø 16.0)			
	Drain		Ø 5/8 (Ø 16.0)			
Max. Interunit Piping Length			98-3/8 (29.8)			
Max. Interunit Height Difference			65-5/8 (20)			
Chargeless			32-13/16 (9.8)			
Amount of Additional Charge of Refrigerant	oz/ft. (g/m)		0.32 (30)			
Operating Range - Cooling			50° - 115°F			
Operating Range - Enhanced Cooling*			14° - 115°F			
Operating Range - Low Ambient Cooling**			-4° - 115°F			
Operating Range - Ultra Low Ambient Cooling***			-22° - 115°F			
Airflow Rate	Indoor Unit		FTX30NVJU		FTX36NVJU	
	H	cfm (m³/min)	890 (25.2)		915 (25.9)	
	M		727 (20.6)		742 (21.0)	
	L		572 (16.2)		572 (16.2)	
SL	512 (14.5)		512 (14.5)			
Fan	Speed	Steps	5 Steps, Quiet, Auto			
Air Direction Control			Right, Left, Horizontal, Downward			
Air Filter			Removable, Washable			
Dimensions (H x W x D)	in. (mm)		13-3/8 x 47-1/4 x 10-3/16 (340 x 1,200 x 259)			
Weight	lbs. (kg)		38 (17)			
Sound Pressure Level (H / M / L / SL)	dB(A)		53 / 47 / 40 / 37		54 / 47 / 40 / 37	
Compressor	Outdoor Unit		RK30NMVJUA		RK36NMVJUA	
	Motor Output	W	1,920			
	Type		R-410A			
	Charge	lbs. (kg)	3.64 (1.65)		3.64 (1.65)	
Airflow Rate	H	cfm (m³/min)	2,528 (71.6)		2,811 (79.6)	
	SL		—		—	
Dimensions (H x W x D)	in. (mm)		28-15/16 x 34-1/4 x 12-5/8 (735 x 870 x 320)			
Weight	lbs. (kg)		133 (60)		133 (60)	
Sound Pressure Level	H	dB(A)	56		59	

\*Activated with a dipswitch setting. Refer to installation manual for more details.

\*\*Activated with a dipswitch setting and use of air direction adjustment grille (KPW063B4). Refer to installation manual for more details.

\*\*\*Activated with additional dipswitch setting and notes per \*\*. Refer to installation manual for more details.

Unit Combination		Power Supply				Compressor		OFM		IFM	
INDOOR UNIT	OUTDOOR UNIT	Hz - VOLTS	VOLTAGE RANGE	MCA	MOP	RLA	W	FLA	W	FLA	
FTX30NVJU	RK30NMVJUA	60 - 208	Min. 187 V Max. 253 V	17	20	16.25	93	0.62	64	0.37	
		60 - 230									
FTX36NVJU	RK36NMVJUA	60 - 208	Min. 187 V Max. 253 V	17	20	16.25	123	0.83	64	0.37	
		60 - 230									

# Daikin NV series

## Wall-Mounted Heat Pump

Up to 17.5 SEER | Up to 9.3 HSPF

COMFORTABLE LIMITED WARRANTY\* PROTECTION



\* Complete warranty details available from your local dealer/contractor or at [www.daikincomfort.com](http://www.daikincomfort.com). Warranty registration not required to receive the 10-Year Parts Limited Warranty for residential or commercial installations.. The duration of warranty coverages in Texas differs in some cases.



Model	Indoor Unit		FTX30NVJU RX30NMVJUA		FTX36NVJU RX36NMVJUA	
	Outdoor Unit		Cooling	Heating	Cooling	Heating
Capacity Rated (Min. ~ Max.)	Btu/h		31,400 (10,200 ~ 31,400)	34,800 (10,200 ~ 34,800)	34,400 (10,200 ~ 34,400)	36,000 (10,200 ~ 36,000)
Moisture Removal	gal/h		N/A		N/A	
CDP Rated			2.92		2.78	
EER Rated			9.85		9.1	
SEER			17.5		15.9	
HSPF			9.3		9.2	
Piping Connections	Liquid	in. (mm)	Ø 1/4 (Ø 6.4)			
	Gas		Ø 5/8 (Ø 16.0)			
	Drain		Ø 5/8 (Ø 16.0)			
Max. Interunit Piping Length			98-3/8 (29.8)			
Max. Interunit Height Difference	ft. (m)		65-5/8 (20)			
Chargeless			32-13/16 (9.8)			
Amount of Additional Charge of Refrigerant	oz/ft. (g/m)		0.32 (30)			
Operating Range - Cooling			50° - 115°F			
Operating Range - Enhanced Cooling**	°F DB		14° - 115°F			
Operating Range - Low Ambient Cooling***			-4° - 115°F			
Operating Range - Heating*	°F WD		5° - 65°F			
Indoor Unit		FTX30NVJU		FTX36NVJU		
Airflow Rate	H	cfm (m³/min)	890 (25.2)	960 (27.2)	915 (25.9)	960 (27.2)
	M		727 (20.6)	791 (22.4)	742 (21.0)	791 (22.4)
	L		572 (16.2)	629 (17.8)	572 (16.2)	629 (17.8)
	SL		512 (14.5)	544 (15.4)	512 (14.5)	544 (15.4)
Fan	Speed	Steps	5 Steps, Quiet, Auto			
Air Direction Control		Right, Left, Horizontal, Downward				
Air Filter		Removable, Washable				
Dimensions (H x W x D)		in. (mm)	13-3/8 x 47-1/4 x 10-3/16 (340 x 1,200 x 259)			
Weight		lbs. (kg)	38 (17)			
Sound Pressure Level (H / M / L / SL)		dB(A)	53 / 47 / 40 / 37	53 / 46 / 38 / 35	54 / 47 / 40 / 37	53 / 46 / 38 / 35
Outdoor Unit		RX30NMVJUA		RX36NMVJUA		
Compressor	Motor Output	W	1,920		1,920	
Refrigerant	Type	R-410A				
	Charge	lbs. (kg)	3.64 (1.65)		3.64 (1.65)	
Airflow Rate	H	cfm (m³/min)	2,528 (71.6)	2,274 (64.4)	2,811 (79.6)	2,352 (66.6)
	SL		—			
Dimensions (H x W x D)		in. (mm)	28-15/16 x 34-1/4 x 12-5/8 (735 x 870 x 320)			
Weight		lbs. (kg)	133 (60)		133 (60)	
Sound Pressure Level		dB(A)	56	58	59	

\*Applicable to heat pump models only, refer to installation manual for more details.

\*\* Activated with a dipswitch setting. Refer to installation manual for more details.

\*\*\* Activated with a dipswitch setting and use of air direction adjustment grille (KPW063B4). Refer to installation manual for more details.

Unit Combination		Power Supply				Compressor	OFM		IFM		
INDOOR UNIT	OUTDOOR UNIT	Hz - VOLTS	VOLTAGE RANGE		MCA	MOP	RLA	W	FLA	W	FLA
FTX30NVJU	RX30NMVJUA	60 - 208	Min. 187 V Max. 253 V		19.8	20	18.25	93	0.62	64	0.37
		60 - 230									
FTX36NVJU	RX36NMVJUA	60 - 208	Min. 187 V Max. 253 V		19.8	20	18.25	123	0.83	64	0.37
		60 - 230									





# Daikin LV 30/36 Wall-Mount Cooling Only

Up to 19.3 SEER | 10.7 EER

COMFORTABLE LIMITED WARRANTY\* PROTECTION



\* Complete warranty details available from your local dealer/contractor or at [www.daikincomfort.com](http://www.daikincomfort.com). Warranty registration not required to receive the 10-Year Parts Limited Warranty for residential or commercial installations.

Daikin's LV 30/36 Wall-Mount offers Cooling Only solutions for larger capacity applications. With the optional Ultra Low Ambient Kit, cooling range can be extended to -40°F which is perfect for process cooling applications. The LV 30/36 also has some great features for comfort cooling applications like Comfort Airflow, 3-D Airflow, and an Intelligent Eye for room occupancy sensing.

## Standard Features

- » Energy Efficient – Up to 19.3 SEER, up to 10.7 EER – Variable-Speed, Inverter, Compressor
- » Cooling Range: 50° - 115°F (Extended operation to 0° - 115°F with facility setting and air adjustment grille)
- » Heating Range: 5° - 65°F
- » Indoor Sound Pressure as Low as 37 dB(A)
- » Outdoor Sound Pressure as Low as 51 dB(A)
- » Intelligent Eye
- » Power airflow dual flaps and 3-D Airflow
- » Titanium Apatite Photocatalytic Air Purifying Filter
- » Weekly timer
- » Program Dry Function
- » Econo Mode
- » Powerful Operation Mode
- » Backlit Wireless Remote Controller
- » Auto-Fan Speed Control
- » Self Diagnostics with Digital Display
- » Auto-Restart After Power Failure
- » Anti-Corrosion Heat Exchanger Treatment
- » Compatible with Daikin *One+* Smart Thermostat, DKN Residential Cloud Wi-Fi Adaptor, or DKN Plus Interface

## IDEAL SOLUTIONS FOR:

- › Renovations, remodeling and new construction
- › Sun rooms, basements, garages, rooms with poor airflow
- › Ceiling void or attic does not allow for a viable standard ducted solution
- › Mechanical Rooms
- › Server Rooms



**Intelligent Eye** – The intelligent eye is an infrared sensor with the ability to sense movement in the room. When you are in the room, the air conditioner operates normally. If you leave the room for more than 20 minutes the air conditioner automatically changes to an energy-saving operation. Using the intelligent eye, savings of up to 20% in cooling and up to 30% in heating can be achieved compared to units without this feature.



**Titanium Apatite Photocatalytic Air Purifying Filter** – This filter combines the air-purifying filter and titanium apatite photocatalytic deodorizing filter in a single highly effective unit.



**3-D Airflow** – Combines vertical and horizontal auto-swing to circulate cool/warm air to the corners of large spaces.



Part Number	Optional Accessories for Indoor Unit
BRC944B2-A08	Wired Remote Controller
BRCW901A08	Wired Remote Controller Cord (Shielded Wire) 26.3 ft
KAF970A48	Titanium Apatite Deodorizing Filter (Without frame) Standard
KKF910AA4	Remote Controller Loss Prevention with Chain
DTST-ONE-ADA-A	Daikin <i>One+</i> Smart Thermostat
AZAI6WSCDKB	DKN Residential Cloud Wi-Fi Adaptor
AZAI6WSPDKC	Daikin DKN Plus Interface
Part Number	Optional Accessories for Outdoor Unit
KPW5G112	Air Adjustment Grille
KKG063A42	Back protection wire net
2F018535-1	Ultra Low Ambient Kit (30)
2F018535-2	Ultra Low Ambient Kit (36)

# Daikin LV 30/36 Wall-Mount Cooling Only

Up to 19.3 SEER | 10.7 EER

SINGLE ZONE SYSTEMS



Model	Indoor Unit		FTXS30LVJU		FTXS36LVJU	
	Outdoor Unit		RKS30LVJU		RKS36LVJU	
Capacity Rated (Min. ~ Max.)	Btu/h		30,000 (10,200 ~ 30,000)		36,000 (10,200 ~ 36,000)	
Moisture Removal	gal/h		1.5		1.8	
EER Rated			10.71		8.37	
SEER			19.3		17.9	
Piping Connections	Liquid	in. (mm)	Ø 3/8 (Ø 9.5)			
	Gas		Ø 5/8 (Ø 16.0)			
	Drain		Ø 5/8 (Ø 16.0)			
Max. Interunit Piping Length	ft. (m)		98-1/2 (30)			
Max. Interunit Height Difference			65-5/8 (20)			
Chargeless			32-13/16 (10)			
Amount of Additional Charge of Refrigerant	oz./ft. (g/m)		0.21 (20)			
Operating Range - Cooling			50° – 115°F			
Operating Range - Low-Ambient Cooling*			14° – 115°F			
Operating Range - Cooling with Optional Air Adjustment Grille*	°F DB		0° – 115°F			
Operating Range - Cooling with Ultra Low-Ambient kit and Optional Air Adjustment Grille			-40° – 115°F			
Indoor Unit			FTXS30LVJU		FTXS36LVJU	
Airflow Rate	H	cfm (m³/min)	706 (20)		770 (21.8)	
	M		611 (17.3)		635 (18.0)	
	L		519 (14.7)		519 (14.7)	
	SL		473 (13.4)		473 (13.4)	
Fan	Speed	Steps	5 Steps, Quiet, Auto			
Air Direction Control			Right, Left, Horizontal, Downward			
Air Filter			Removable, Washable			
Dimensions (H x W x D)	in. (mm)		13-3/8 x 47-1/4 x 9-7/16 (340 x 1,200 x 240)			
Weight	lbs. (kg)		38 (17)			
Sound Pressure Level (H / M / L / SL)	dB(A)		47/45/40/37		49/45/40/37	
Outdoor Unit			RKS30LVJU		RKS36LVJU	
Compressor	Motor Output	W	2,030			
Refrigerant	Type		R-410A			
	Charge	lbs. (kg)	6.17 (2.8)			
Airflow Rate	H	cfm (m³/min)	2,627 (74.4)			
	SL		2,316 (65.6)		2,316 (35.6)	
Dimensions (H x W x D)	in. (mm)		38-15/16 x 37 x 12-5/8 (990 x 940 x 320)			
Weight	lbs. (kg)		179 (81)			
Sound Pressure Level	H		54			

\* Cutting a jumper or a dipswitch setting is required. Refer to installation manual.

Unit Combination		Power Supply				Compressor	OFM		IFM	
INDOOR UNIT	OUTDOOR UNIT	Hz - VOLTS	VOLTAGE RANGE	MCA	MOP	RLA	W	FLA	W	FLA
FTXS30LVJU	RKS30LVJU	60 - 208	Min. 187 V Max. 253 V	19.5	20	13.5	200	0.39	64	0.37
		60 - 230				12.2		0.35		0.34
FTXS36LVJU	RKS36LVJU	60 - 208	Min. 187 V Max. 253 V	19.5	20	18.9	200	0.39	64	0.37
		60 - 230				18.4		0.35		0.34

# Daikin *ATMOSPHERA*

## Single Zone Heating and Cooling System

Up to 27.4 SEER | Up to 13.8 HSPF



### COMFORTABLE LIMITED WARRANTY\* PROTECTION

\* Complete warranty details available from your local dealer/contractor or at [www.daikincomfort.com](http://www.daikincomfort.com). To receive the 12-Year Parts Limited Warranty, online registration must be completed within 60 days of installation. Online registration is not required in California or Québec. The duration of warranty coverages in Texas differs in some cases. *If product installed in a commercial application, limited warranty period is 5 years.*

The Daikin *ATMOSPHERA* Single Zone System is ideal for spot cooling and heating needs in residential and commercial spaces that require heating and cooling even in extreme ambient temperatures. In addition, Daikin *ATMOSPHERA* is an effective source of heat to offset old, inefficient furnaces or boiler systems.

### Standard Features

- » Energy Efficient – Up to 27.4 SEER / Up to 13.8 HSPF / Up to 16.3 EER for ultra-efficient cooling and heating operation and reduced operating costs compared to conventional lower-efficiency systems.
- » Enhanced Capacity –
  - Up to 100% rated heating capacity at 5°F WB (-15°C WB) and confirmed continuous operation as low as -13°F WB (-25°C WB) ambient temperature
  - Up to 100% rated cooling capacity at 115°F (46°C)
- » Aligning with Goals of –
  - Decarbonization and Electrification moving towards clean energy: An effective source of heat to comfortably offset older or inefficient sources of heat using fossil fuels
  - Lower GWP refrigerant reduce emissions at the source: Utilizing a refrigerant with lower Global Warming Potential (GWP) compared to conventional refrigerants



**Hybrid Cooling** – Dehumidifies efficiently even in low cooling loads, and maintains dehumidification effect after the target temperature is reached.

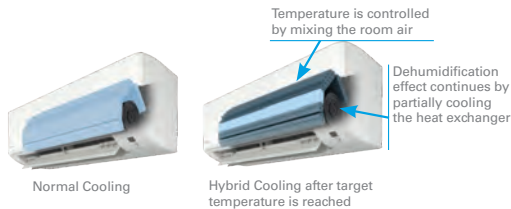

**CLEAN Operation** – The CLEAN function dries the interior of the indoor unit to reduce the amount of condensation present. When COOL or DRY operation is performed, condensation may occur inside the air conditioner. It is recommended to dry the inside of the air conditioner using CLEAN operation.

### IDEAL SOLUTIONS FOR:

- › Primary living areas (for example, master bedrooms and living rooms)
- › Hot or cold rooms
- › Rooms with poor air flow



**Daikin Comfort Control** – With the Daikin Comfort Control app you are always in control. You can use your tablet or smart-phone to access your Daikin *ATMOSPHERA* system via the internet, no adaptor required.



**3-D Airflow** – Combines vertical and horizontal auto-swing to circulate cool/warm air to the corners of large spaces.



**Simplified Maintenance** –The indoor unit has been re-designed for easier removal of the drain pan (compared to other wall-mounted units).



**Powerful Operation** – Pushing the POWERFUL button on the remote control gives you a boost in cooling or heating power for a 20-minute period, even if the unit is already operating at high capacity.



**Comfort Mode** – When cooling, the flap positions itself horizontally to keep cold airflow from being blown directly onto the body. When heating, the flap turns vertically downwards to drive warm air to the bottom of the room.



**Intelligent Eye** – An infrared sensor with the ability to sense movement in the room. If the room is empty for 20 minutes, it changes the set point to start saving energy.



**Increased Factory Charge and piping allowances.** – Daikin *ATMOSPHERA* is pre-charged to serve piping lengths up to 49 ft. (15m), a 50% increase in pre-charge coverage compared to previous models.

Part Number	Optional accessories for Indoor Unit	Part Number	Optional Accessories for Outdoor Unit
BRC944B2-A08*	Wired Remote Controller kit	DACA-WB-1	Powder-Coated Wall-Mounted Bracket
BRCW901A08	Wired Remote Controller Cord - 8m	KPW937F4E	Air Direction Adjustment Grille (09 & 12)
DACA-BRCW901P10	Remote Controller Cable, Plenum Rated, 10 ft	KPW063B4	Air Direction Adjustment Grille (18 & 24)
DACA-BRCW901P25	Remote Controller Cable, Plenum Rated, 25 ft	KEH094A41E	Drain Pan Heater Small (09 & 12)
KAF970A46	Titanium Apatite Deodorizing filter (without frame)	KEH063A4E(A)	Daikin BML Drain Pan Heater Large (18 & 24)
DACA-CP4-1	Condensate Pump	KKG020A41	Back Protection Wire Net (09 & 12)
DACA-CP1-1	Inline Condensate Pump	KKG063A42	Back Protection Wire Net (18 & 24)
DTST-ONE-ADA-A*	Daikin <i>One+</i> Smart Thermostat	KPS034A41	Snow hood (intake side plate) (09 & 12)
AZAI6WSCDKB*	DKN Residential Cloud Wi-Fi Adaptor	KPS063A41	Snow hood (intake side plate) (18 & 24)
AZAI6WSPDKC*	Daikin DKN Plus Interface	KPS034D42	Snow hood (intake rear plate) (09 & 12)
		KPS063A44	Snow hood (intake rear plate) (18 & 24)
		KPS034A43	Snow hood (outlet) (09 & 12)
		KPS063A47	Snow hood (outlet) (18 & 24)
		KKP937A4	Drain Plug

\* requires KER087A41 s21 conversion connector

# Daikin *ATMOSPHERA* Single Zone Heating and Cooling System Up to 27.4 SEER | Up to 13.8 HSPF



SINGLE ZONE SYSTEMS

Model	Indoor Unit		FTXM09VVJU RXM09VVJU		FTXM12VVJU RXM12VVJU		FTXM18VVJU RXM18VVJU		FTXM24VVJU RXM24VVJU	
	Outdoor Unit		Cooling	Heating	Cooling	Heating	Cooling	Heating	Cooling	Heating
Capacity Rated (Min. ~ Max.)	Btu/h		9,000 (4,400 ~ 12,500)	11,000 (4,400 ~ 19,500)	12,000 (4,800 ~ 16,000)	13,600 (4,800 ~ 22,600)	18,000 (9,000 ~ 22,000)	21,600 (9,000 ~ 30,200)	21,600 (9,000 ~ 26,000)	24,000 (9,000 ~ 32,200)
Max Heating Capacity at 5°F (-15°C)			-	11,000	-	13,600	-	21,600	-	24,000
Max Heating Capacity at -13°F (-25°C)			-	10,000	-	10,700	-	16,200	-	18,000
COP Rated			4.6		4.4		3.8		3.54	
COP at 5°F (-15°C)			2		2		1.8		1.8	
EER Rated			16.3		13.2				12.5	
SEER			27.4		25.2		22.7		22	
HSPF			13.8		13				12.5	
Piping Connections	Liquid	in. (mm)	Ø 1/4 (Ø 6.4)							
	Gas		Ø 3/8 (Ø 9.5)				Ø 1/2 (Ø 12.7)		Ø 5/8 (Ø 15.9)	
	Drain		Ø 5/8 (Ø 16.0)							
Max. Interunit Piping Length	ft. (m)		82-1/64 (25)				98-1/2 (30)			
Max. Interunit Height Difference	ft. (m)		65-5/8 (20)				82-1/64 (25)			
Chargeless			49.2 (15)							
Amount of Additional Charge of Refrigerant	oz./ft. (g/m)		0.22 (20)							
Operating Range - Cooling	°F DB (°C DB)		50 ° - 114.8 °F (10 ° - 46 °C)							
Operating Range - Low-Ambient Cooling*	°F DB (°C DB)		14 ° - 114.8 °F (-10 ° - 46 °C)							
Operating Range - Cooling with Optional Air Adjustment Grille*	°F DB (°C DB)		-4 ° - 114.8 °F (-20 ° - 46 °C)							
Operating Range - Heating†	°F WB (°C WB)		-13 ° - 64.4 °F (-25 °C - 18 °C)							
<b>Indoor Unit</b>			<b>FTXM09VVJU</b>		<b>FTXM12VVJU</b>		<b>FTXM18VVJU</b>		<b>FTXM24VVJU</b>	
Airflow Rate	H	cfm (m³/min)	515 (14.6)	515 (14.6)	557 (15.8)	557 (15.8)	776 (22.0)	776 (22.0)	845 (23.9)	845 (23.9)
	M		340 (9.6)	370 (10.5)	394 (11.2)	412 (11.7)	583 (16.5)	559 (15.8)	652 (18.5)	606 (17.2)
	L		249 (7.1)	304 (8.6)	292 (8.3)	340 (9.6)	482 (13.7)	467 (13.2)	498 (14.1)	498 (14.1)
	SL		219 (6.2)	249 (7.1)	225 (6.4)	255 (7.2)	360 (10.2)	399 (11.3)	451 (12.8)	451 (12.8)
Fan	Speed	Steps	5 Steps, Quiet, Auto							
Air Direction Control			Right, Left, Horizontal, Downward							
Air Filter			Removable, Washable							
Dimensions (H x W x D)	in. (mm)		11-3/4 x 36-1/4 x 10-13/16 (299 x 920 x 275)				11-3/4 x 43-5/16 x 10-13/16 (299 x 1,100 x 275)			
Weight	lbs. (kg)		29 (13)				33 (15)			
Sound Pressure Level (H / M / L / SL)	dB(A)		45 / 33 / 25 / 22	43 / 35 / 30 / 25	45 / 37 / 29 / 23	45 / 39 / 32 / 26	49 / 41 / 36 / 33	49 / 40 / 35 / 32	51 / 44 / 37 / 34	51 / 42 / 37 / 34
<b>Outdoor Unit</b>			<b>RXM09VVJU</b>		<b>RXM12VVJU</b>		<b>RXM18VVJU</b>		<b>RXM24VVJU</b>	
Refrigerant	Type	R-32								
	Charge	lbs. (kg)	2.16 (0.98)				2.98 (1.35)			
Airflow Rate	H	cfm (m³/min)	1,317 (37.3)	1,296 (36.7)	1,487 (42.1)	1,487 (42.1)	2,119 (60.0)	2,062 (58.4)	2,179 (61.7)	2,119 (60.0)
	SL	cfm (m³/min)	1,183 (33.5)	922 (26.1)	1,317 (37.3)	922 (26.1)	1,833 (51.9)	1,773 (50.2)	1,833 (51.9)	1,833 (51.9)
Dimensions (H x W x D)	in. (mm)		23-7/16 x 33-1/4 x 11-13/16 (595 x 845 x 300)				28-15/16 x 34-1/4 x 12-5/8 (735 x 870 x 320)			
Weight	lbs. (kg)		96 (44)				132 (60)			
Sound Pressure Level	H	dB(A)	47	49	49	52	54	55	55	56

\* Cutting a jumper or a dipswitch setting is required. Refer to installation manual.

† The installation of an optional drain-pan is recommended in areas where ambient temperature may fall below 5 °F (-15 °C) or in areas of heavy snowfall or high levels of wintertime humidity.

Unit Combination		Power Supply				Compressor	OFM		IFM	
INDOOR UNIT	OUTDOOR UNIT	Hz - VOLTS	VOLTAGE RANGE	MCA	MOCP	RLA	W	FLA	W	FLA
FTXM09VVJU	RXM09VVJU	60 - 208	Min. 187 V Max. 253 V	12.3	15	12	37	0.31	27	0.25
		60 - 230								
FTXM12VVJU	RXM12VVJU	60 - 208	Min. 187 V Max. 253 V	12.3	15	12	37	0.31	27	0.25
		60 - 230								
FTXM18VVJU	RXM18VVJU	60 - 208	Min. 187 V Max. 253 V	18.8	20	18.25	123	0.58	61	0.46
		60 - 230								
FTXM24VVJU	RXM24VVJU	60 - 208	Min. 187 V Max. 253 V	19.8	20	18.25	123	0.58	61	0.46
		60 - 230								

• Daikin *ATMOSPHERA* not available in all markets. Contact your local distributor for regional needs and authorized sales of this product.



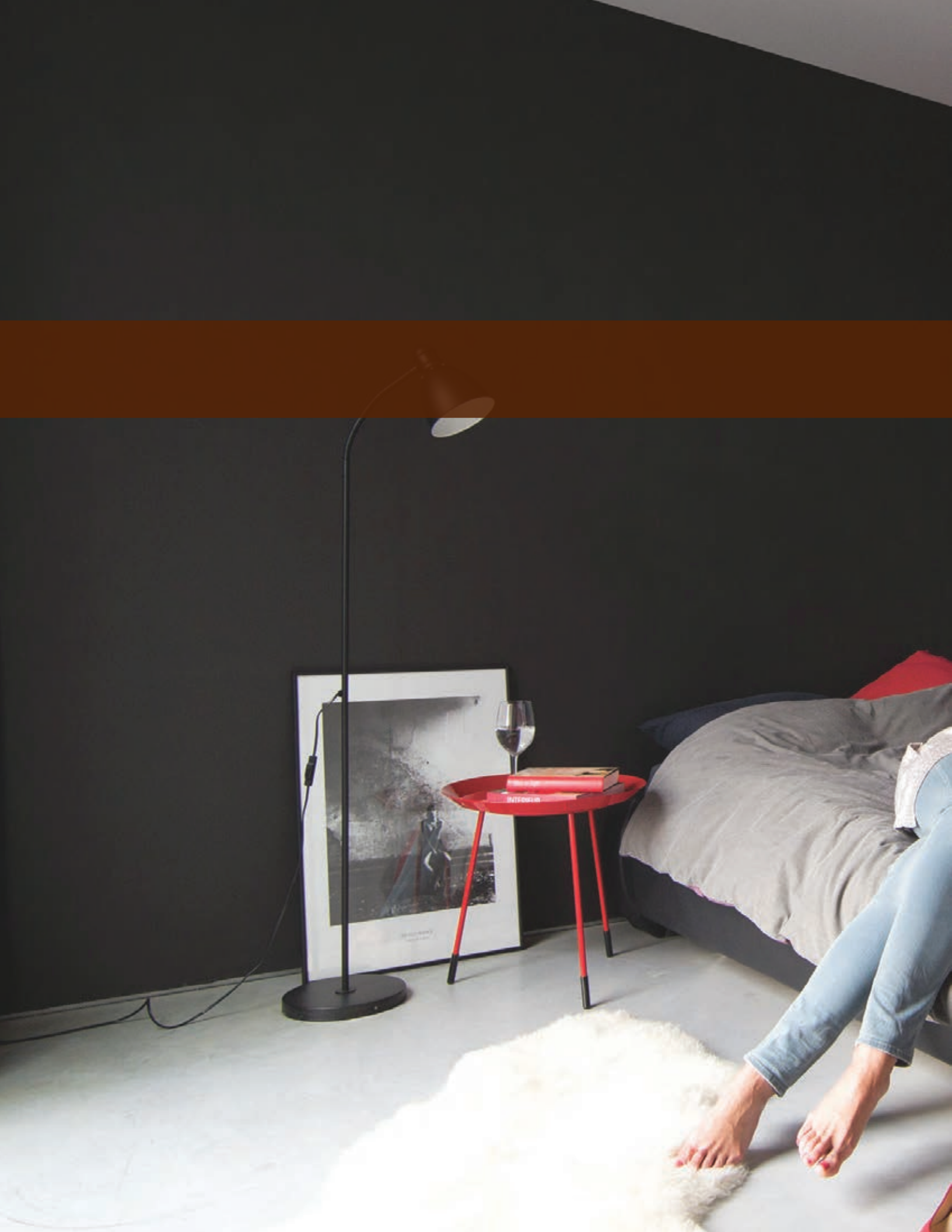



# Multi-Zone Systems



# Multi-Zone Systems



## Ideal Solutions for:

	Wall-Mounted	Ducted	DAIKIN VISTA Cassette	Floor-Mounted
Primary living areas (master bedrooms and living rooms)	✓	✓	✓	✓
Hot or cold rooms	✓	✓	✓	✓
Rooms with poor air flow	✓	✓	✓	✓
New construction	✓	✓	✓	✓
Renovations and remodeling	✓	✓		✓
Secondary bedrooms, offices, garages, basements, attics, and sun rooms	✓	✓		✓
Rooms with soffit ceilings and areas that require short duct runs		✓		
Units can be installed in conditioned spaces or in unconditioned spaces if unit is properly insulated.		✓		
Desire of innovative design and features	✓		✓	

**MULTI-ZONE 1**  
76°F

**MULTI-ZONE 2**  
70°F

**MULTI-ZONE 3**  
74°F

**MULTI-ZONE 4**  
68°F

**SINGLE ZONE**  
OFF

**TRUE ZONING FOR IDEAL COMFORT**

MULTI-ZONE OUTDOOR UNIT

SINGLE ZONE OUTDOOR UNIT



## Zoned comfort control

Homeowners fight over temperatures in their homes and have rooms that go unused for long periods. Now they can save energy and control temperatures independently in up to eight separate zones with a single outdoor unit. With available wall-mounted, concealed slim-duct, ceiling cassette, and floor-mounted indoor options, Daikin Multi-Zone Systems offer multiple indoor unit styles to meet all home comfort needs.

## Heat or cool multiple spaces independently with 1 outdoor unit

- » Great installation flexibility and a wide choice of styles.
- » Wide range of outdoor units, to which up to 8 indoor units can be connected.
- » All indoor units can be individually controlled.
- » The discrete, robust outdoor unit can easily be mounted onto a roof or terrace, or simply to the outside wall.
- » It is possible to combine different types of indoor units.

### Compatible Indoor Units:



#### Daikin *EMURA* - Designed to perfectly balance technological capability and the beauty of aerodynamics

- » Iconic award winning design and engineering excellence
- » Elegant finish in pure matte white or modern silver
- » Two-area intelligent eye sensor controls comfort and allows for energy savings during unoccupied periods
- » Titanium apatite photo-catalytic air purification

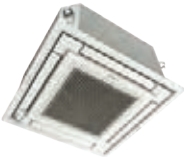

#### Daikin *VISTA* - Unique design that integrates seamlessly into the ceiling

- » Iconic award winning design and engineering excellence
- » Elegant finish in white or silver / white combination
- » DC fan motor and two optional intelligence sensors for energy efficiency
- » Outside air integration possible of up to 2-3% of the nominal indoor air volume



#### Daikin *FTXS* - Discreet wall-mounted unit providing high efficiency and comfort

- » Discreet, stylish front panel blends easily with the wall, and matches all interior decors
- » Dry program allows humidity levels to be reduced without variations in room temperature
- » Intelligent Eye function reduces heating or cooling operation during unoccupied periods



#### Daikin *FVXS* - Floor mounted unit for optimal heating comfort thanks to dual airflow

- » Its low height enables the unit to fit beneath a window
- » Can be installed against a wall or recessed
- » Vertical auto swing moves the louver up and down for efficient air and temperature distribution



#### Daikin *FDMQ* - Ducted concealed unit capable of up to .6 esp

- » Higher external static pressure capabilities allow for longer duct runs and easily implementing up to MERV 13 filters (compared to units with lower static pressure)
- » Drain Pan inspection port makes it easy to observe drain pan conditions
- » Rear or bottom return air configurations for installation flexibility
- » Outside air integration possible



#### Daikin *FDXS/CDXS* - Slim duct concealed ceiling unit capable of up to 0.18 esp

- » External static pressure facilitates unit's use with minimal length of duct runs
- » Discretely concealed in the ceiling: only the suction and discharge grills are visible
- » DC fan motor for low energy consumption



# Multi-Zone Systems OUTDOOR UNITS Daikin *AURORA*

Up to 20 SEER2 | Up to 9.7 HSPF2

COMFORTABLE LIMITED  
WARRANTY\* PROTECTION



\* Complete warranty details available from your local dealer/contractor or at [www.daikincomfort.com](http://www.daikincomfort.com). To receive the 12-Year Parts Limited Warranty, online registration must be completed within 60 days of installation. Online registration is not required in California or Québec. The duration of warranty coverages in Texas differs in some cases. *If product installed in a commercial application, limited warranty period is 5 years.*

The Daikin *AURORA* multi-zone system is a flexible solution for individual zone comfort. Connecting up to 4 indoor units to a single outdoor unit reduces installation space and costs while maximizing comfort and energy efficiency. With a choice of 6 indoor unit types in a wide range of capacities, For all regions, the outdoor units of the multi-zone *AURORA* heat pump system have been redesigned to withstand extreme weather conditions with excellent energy efficiency ratings.

## Standard Features

- » Multi-Zone comfort: One outdoor unit connects up to four separate fan coils individually controlled
- » Energy Efficient – Up to 20 SEER2; up to 9.7 HSPF2; Up to 12 EER2 – Variable-Speed, Inverter, Compressor
- » Cooling Range 14° - 115°F
- » Heating Range -13° - 60°F
- » Up to 100% rated heating capacity at 5°F WB (-15°C WB) with confirmed continuous operation down to -13°F WB (-25°C WB)
- » Quick and easy installation
- » Precision temperature control for individual rooms
- » Space-saving design
- » Quiet operation
- » Fully optimized for R-410A refrigerant
- » World renowned Daikin Inverter "Variable-Speed" compressor technology
- » Add Bullet point - 100% cooling capacity at 115F

Part Number	Optional Accessories for Outdoor Unit
KPW063B4	Air Direction Adjustment grille (2/3MXL)
KKG063A42	Back protection wire net (2/3MXL)
KKP937A4	Drain plug (2/3MXL)
KEH063A41E	Drain pan heater (2/3MXL)
KPS063A41	Snow hood (intake side plate) (2/3MXL)
KPS063A44	Snow hood (intake rear plate) (2/3MXL)
KPS063A47	Snow hood (outlet) (2/3MXL)
KEH082A41A	Drain pan heater (4MXL)
KPW082A41	Air Direction Adjustment grille (4MXL)
KKG082A41	Back protection wire net (4MXL)
RAQAHLGD1	Rear coil guard (2/3MXL)

## IDEAL SOLUTIONS FOR:

- › Primary living area (master bedrooms and living rooms)
- › Hot or cold rooms
- › Rooms with poor air flow
- › Renovations and remodeling
- › Basements, attics and garages
- › New construction



**Daikin *AURORA* heat pump for extreme weather conditions** – Up to 100% rated heating capacity at 5°F WB (-15°C WB) and confirmed continuous operation, as low as -13°F WB (-25°C WB) ambient temperature.



**Outdoor Unit Quiet Operation** – can reduce sound levels by 3dB for times when quieter operation is needed.



**Auto-Restart** – The unit memorizes the operation mode, airflow and temperature settings. Should there be a power failure when the unit is in operation, it will automatically return to the same operating conditions when the power is restored.



**Intelligent Defrost Mode\*** – The outdoor unit will enable this mode to help prevent frost/ice from building up in cold climate conditions. It will also help with longer heating operation time for additional comfort for occupants (compared to HVAC systems without this function).\*available on 4MXL only



2/3MXL outdoor unit drain pans have up to 14 holes which allows for effective drainage of condensation. In some case, this improved drain pan design eliminates the need for drain pan heaters, resulting in higher efficiencies in low ambient temperatures.



**New Drain Pan** – 4MXL newly designed drain pan on outdoor unit to help prevent condensate from freezing and causing damage to the fan and coil.



2/3MXL

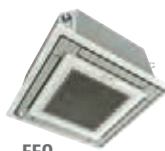

FFQ



4MXL

## Daikin *EMURA*

Up to 4 indoor units



FTXR



FDMQ



CTXS/FTXS



FVXS

# Multi-Zone Systems OUTDOOR UNITS Daikin *AURORA* Up to 20 SEER2 | Up to 9.7 HSPF2

MULTI-ZONE SYSTEMS

Model			2MXL18WMVJU9		3MXL24WMVJU9		4MXL36VVJU9	
			Cooling	Heating	Cooling	Heating	Cooling	Heating
Capacity Rated	Btu/h		17,800	18,500	24,000	24,000	34,000	36,600
COP Rated (Min. - Max.)			—		4.2		—	
EER2 Rated (Min. - Max.)			12		—		11.7	
SEER2 / HSPF2			See Performance Table below					
Compressor	Motor Output	W	1,920				3,000	
Refrigerant	Type		R-410A					
	Charge	lbs. (kg)	6.17 (2.8)				8.60 (3.9)	
Airflow Rate	H	cfm (m <sup>3</sup> /min)	2,151 (60.9)	2,180 (61.7)	2,094 (59.3)	2,094 (59.3)	3,684 (104.3)	3,356 (95)
	M		2,151 (60.9)	2,180 (61.7)	2,094 (59.3)	1,979 (56.0)	3,029 (85.8)	3,138 (88.9)
	L		1,950 (55.2)	1,118 (31.6)	1,977 (56.0)	1,118 (31.6)	2,756 (78.0)	1,500 (42.5)
Fan	Motor Output	W	78		89		126	
	Running Current	A	H: 0.29 / M: 0.29 / L: 0.22	H: 0.30 / M: 0.30 / L: 0.05	H: 0.27 / M: 0.27 / L: 0.23	H: 0.27 / M: 0.23 / L: 0.05	H: 0.76 / M: 0.45 / L: 0.35	H: 0.59 / M: 0.49 / L: 0.17
	Power Consumption	W	H: 60.1 / M: 60.1 / L: 46.1	H: 62.3 / M: 62.3 / L: 11.1	H: 55.8 / M: 55.8 / L: 48	H: 55.8 / M: 48 / L: 11.1	H: 158.5 / M: 93.3 / L: 73.2	H: 122.9 / M: 102.5 / L: 34.9
Starting Current	A	15.5			17.5		27.0	
Dimension (H x W x D)	in. (mm)	28-15/16 x 34-1/4 x 12-5/8 (735 x 870 x 320)					34-1/4 x 43-5/16 x 18-1/8 (870 x 1,100 x 460)	
Weight	lbs. (kg)	142			143		214 (97)	
Sound Pressure Level	dB(A)	50	51	52	54	53	55	
Piping Connections	Liquid	in. (mm)	Ø 1/4 x 2 (Ø 6.4 x 2)		Ø 1/4 x 3 (Ø 6.4 x 3)		Ø 1/4 x 4 (Ø 6.4 x 4)	
	Gas		Ø 3/8 x 1, Ø 1/2 x 1 (Ø 9.5 x 1, Ø 12.7 x 1)		Ø 3/8 x 1, Ø 1/2 x 2 (Ø 9.5 x 1, Ø 12.7 x 2)		Ø 3/8 x 1, Ø 1/2 x 2, Ø 5/8 x 1 (Ø 9.5 x 1, Ø 12.7 x 2, Ø 15.9 x 1)	
	Drain		Ø 5/8 (Ø 15.9)		Ø 1 (Ø 25)			
Max. Interunit Piping Length	ft. (m)	164 (50) (for Total of Each Room)			230 (70) (for Total of Each Room)			
Amount of Additional Charge of Refrigerant	oz/ft. (g/m)	0.21 (20) (98-7/16 ft (30 m) or more)			0.21 (20) (131-5/8 ft (40 m) or more)			
Max. Installation Height Difference	ft. (m)	24-5/8 (7.5) (between Indoor Units)						
Operating Range - Cooling	°F DB	14 ° - 115 °F						
Operating Range - Heating	°F WB	-13 ° - 60 °F						

Outdoor Unit	Power Supply				Compressor		OFM	
	Hz - Volts	VOLTAGE RANGE	MCA	MOCP	MSC	RLA	W	FLA
2MXL18WMVJU9	60 - 208	Min. 187 V Max. 253 V	17	20	15.5	15.5	78	0.43
	60 - 230							
3MXL24WMVJU9	60 - 208	Min. 187 V Max. 253 V	20.1	25	17.5	17.5	89	0.49
	60 - 230							
4MXL36VVJU9	60 - 208	Min. 187 V Max. 253 V	30.2	35	27	27	126	0.76
	60 - 230							

Performance					
Daikin <i>AURORA</i> Performance	Model	Connected to	SEER2	EER2	HSPF2
		2MXL18WMVJU9	Non-Ducted	16	12
	2MXL18WMVJU9	Ducted	14.3	9	7.7
	2MXL18WMVJU9	Mixed	15.15	10.5	8.2
	3MXL24WMVJU9	Non-Ducted	18	11.7	9.7
	3MXL24WMVJU9	Ducted	14.9	8.5	7.8
	3MXL24WMVJU9	Mixed	16.45	10.1	8.75
	4MXL36VVJU9	Non-Ducted	20	11.7	9
	4MXL36VVJU9	Ducted	15.9	9.3	8.1
	4MXL36VVJU9	Mixed	17.95	10.5	8.55



4MXL

# Multi-Zone Systems

## OUTDOOR UNITS

### Daikin MXS series

Up to 20.6 SEER2 | Up to 9.7 HSPF2

### COMFORTABLE LIMITED WARRANTY\* PROTECTION



\* Complete warranty details available from your local dealer/contractor or at [www.daikincomfort.com](http://www.daikincomfort.com). To receive the 12-Year Parts Limited Warranty, online registration must be completed within 60 days of installation. Online registration is not required in California or Québec. The duration of warranty coverages in Texas differs in some cases. *If product installed in a commercial application, limited warranty period is 5 years.*

The Daikin Multi-Zone System is a flexible solution for individual zone comfort. Connecting up to 5 indoor units to a single outdoor unit, without the use of branch provider (BP) boxes, reduces installation space and costs while maximizing comfort and energy savings. With a choice of six indoor unit types in a wide range of capacities, Daikin Multi-Zone Systems allow mixed and matched combinations.

#### Standard Features

- » Multi-Zone comfort: One outdoor unit connects up to five separate fan coils individually controlled
- » Energy Efficient – up to 20.6 SEER2; up to 9.7 HSPF2; up to 11.8 EER2 — Variable-Speed, Inverter, Compressor
- » Cooling Range 14° - 115°F
- » Heating Range 5° - 60°F
- » Quick and easy installation
- » Precision temperature control for individual rooms
- » Space-saving design
- » Quiet operation
- » Fully optimized for R-410A refrigerant
- » World renowned Daikin Inverter "Variable-Speed" compressor technology
- » Intelligent Defrost Mode\*: The outdoor unit will enable this mode to help prevent frost/ice from building up in cold climate conditions. It will also help with longer heating operation time for additional comfort for occupants (compared to HVAC systems without this function). \*available on 5MXS only

#### IDEAL SOLUTIONS FOR:

- › Entire homes or floors of homes
- › Multiple zones
- › New construction
- › Primary living areas (master bedrooms and living rooms)
- › Basements



2/3/4MXS series models feature an enhanced drain pan with optimal drainage for reduced ice build-up in extreme conditions.



**New Drain Pan** – 5MXS newly designed drain pan on outdoor unit to help prevent condensate from freezing and causing damage to the fan and coil.

Part Number	Optional Accessories for Outdoor Unit
KPW063B4	Air direction adjustment grille
KKG063A42	Back protection wire net
KKP937A4	Drain plug
FTDBHML, KEH063A4E	Drain pan heater
KPS063A41	Snow hood (intake side plate)
KPS063A44	Snow hood (intake rear plate)
KPS063A47	Snow hood (outlet)
RAQAHLD1	Rear coil guard (2/3/4MXS)



#### Up to 5 indoor units

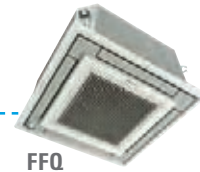

Daikin EMURA



# Multi-Zone Systems OUTDOOR UNITS

## Daikin MXS series

Up to 20.6 SEER2 | Up to 9.7 HSPF2

MULTI-ZONE SYSTEMS

Model		2MXS18WMVJU9		3MXS24WMVJU9		4MXS36WMVJU9		5MXS48WVJU9	
		Cooling	Heating	Cooling	Heating	Cooling	Heating	Cooling	Heating
Capacity Rated	Btu/h	17,500	18,500	24,000	24,000	36,000	36,000	47,000	48,500
COP Rated (Min. - Max.)		—		3.1-4.0		—		3.1-4.5	
EER2 Rated (Min. - Max.)		8.8-11.8		—		8.5-11.7		—	
SEER2 / HSPF2		See Performance Table below							
Compressor	Motor Output Type	W		1,100		1,920		3,000	
Refrigerant	Charge	lbs. (kg)		3.86 (1.75)		6.17 (2.8)		8.60 (3.9)	
Airflow Rate	H	cfm		2,151 (60.9)		2,180 (61.7)		2,094 (59.3)	
	M	m³/min		2,151 (60.9)		2,180 (61.7)		2,094 (59.3)	
	L			1,950 (55.2)		1,118 (31.6)		1,979 (56.0)	
Fan	Motor Output	W		55		50		89	
	Running Current	A		H: 0.37 / M: 0.37 / L: 0.28		H: 0.38 / M: 0.38 / L: 0.06		H: 0.34 / M: 0.34 / L: 0.29	
	Power Consumption	W		H: 75.9 / M: 75.9 / L: 57.2		H: 78.9 / M: 78.9 / L: 12.6		H: 70.2 / M: 70.2 / L: 59.7	
Starting Current	A	14		15.5		17.5		27	
Dimension (H x W x D)	in. (mm)	28-15/16 x 34-1/4 x 12-5/8 (735 x 870 x 320)							
Weight	lbs. (kg)	126		140		144		216 (98)	
Piping Connections	Liquid	Ø 1/4 x 2 (Ø 6.4 x 2)		Ø 1/4 x 3 (Ø 6.4 x 3)		Ø 1/4 x 4 (Ø 6.4 x 4)		Ø 1/4 x 5 (Ø 6.4 x 5)	
	Gas	Ø 3/8 x 1, Ø 1/2 x 1 (Ø 9.5 x 2, Ø 12.7 x 1)		Ø 3/8 x 1, Ø 1/2 x 2 (Ø 9.5 x 1, Ø 12.7 x 2)		Ø 3/8 x 1, Ø 1/2 x 2, Ø 5/8 x 1 (Ø 9.5 x 1, Ø 12.7 x 2, Ø 15.9 x 1)		Ø 3/8 x 1, Ø 1/2 x 2, Ø 5/8 x 2 (Ø 9.5 x 1, Ø 12.7 x 2, Ø 15.9 x 2)	
	Drain	Ø 11/16 (Ø 18.0)		Ø 11/16 (Ø 17.5)		Ø 11/16 (Ø 17.5)		Ø 1 (Ø 25)	
Max. Interunit Piping Length	ft. (m)	164 (50) (for Total of Each Room) 82 (25) (for One Room)		230 (70) (for Total of Each Room) 82 (25) (for One Room)		262 (80) (for Total of Each Room) 98 (30) (for One Room)			
Amount of Additional Charge of Refrigerant	oz/ft. (g/m)	0.21 (20) (98-3/8 ft (30 m) or more)		0.21 (20) (131-1/4 ft (40 m) or more)					
Max. Installation Height Difference	ft. (m)	49-1/4 (15) (between Indoor Unit and Outdoor Unit) 24-5/8 (7.5) (between Indoor Units)							
Operating Range - Cooling	°F DB	14° - 115°F							
Operating Range - Heating	°F WB	5° - 60°F							

Outdoor Unit	Power Supply				Compressor		OFM	
	Hz - VOLTS	VOLTAGE RANGE	MCA	MOCP	MSC	RLA	W	FLA
2MXS18WMVJU9	60 - 208	Min. 187 V Max. 253 V	15.5	20	14	14	55	0.38
	60 - 230							
3MXS24WMVJU9	60 - 208	Min. 187 V Max. 253 V	18.1	25	15.5	15.5	50	0.34
	60 - 230							
4MXS36WMVJU9	60 - 208	Min. 187 V Max. 253 V	20.9	25	17.5	17.5	89	0.49
	60 - 230							
5MXS48WVJU9	60 - 208	Min. 187 V Max. 253 V	30.8	35	27	27	126	0.76
	60 - 230							

Performance					
MXS series Performance	Model	Connected to	SEER2	EER2	HSPF2
		2MXS18WMVJU9	Non-Ducted	16	11.8
	2MXS18WMVJU9	Ducted	14.3	8.8	7.7
	2MXS18WMVJU9	Mixed	15.15	10.3	8.2
	3MXS24WMVJU9	Non-Ducted	18	11.7	9.7
	3MXS24WMVJU9	Ducted	14.9	8.5	7.8
	3MXS24WMVJU9	Mixed	16.45	10.1	8.75
	4MXS36WMVJU9	Non-Ducted	18.1	9.2	9.4
	4MXS36WMVJU9	Ducted	14.9	8	7.8
	4MXS36WMVJU9	Mixed	16.5	8.6	8.6
	5MXS48WVJU9	Non-Ducted	20.6	10.5	9.3
	5MXS48WVJU9	Ducted	14.5	8.2	7.8
	5MXS48WVJU9	Mixed	17.55	9.35	8.55



5MXS



# Multi-Zone Systems Daikin CIRRRA

17 SEER2 | 9 HSPF2 | 10 EER2

COMFORTABLE LIMITED  
WARRANTY\* PROTECTION



\* Complete warranty details available from your local dealer/contractor or at [www.daikincomfort.com](http://www.daikincomfort.com). To receive the 10-Year Parts Limited Warranty, online registration must be completed within 60 days of installation. Online registration is not required in California or Québec. The duration of warranty coverages in Texas differs in some cases.  
*If product installed in a commercial application, limited warranty period is 5 years.*

Daikin's Multi-Zone Systems are ideal for multi-room applications desiring individual room comfort in a space-saving design. With the ability to connect two wall-mounted indoor units to a single outdoor unit, this compact and simple solution can provide additional comfort to spaces where other solutions may not be viable. In addition, with a small outdoor unit footprint, the Daikin CIRRRA Multi-Zone unit takes up less space on a patio or balcony (compared to other Daikin Multi-Zone outdoor units). Suitable for new build and renovation projects, Daikin Multi-Zone Systems are an innovative, reliable solution for your home or space.

## Standard Features

- » Energy Efficient – 17 SEER2; 9 HSPF2; 10 EER2 — Variable-Speed, Inverter, Compressor
- » Cooling Range: 50° - 115°F
- » Heating Range: 5° - 65°F

Outdoor Unit	Optional Accessories
KPW937F4	Air Direction Adjustment grille
KKG067A41E	Back protection wire net
KEH067A41E	Drain pan heater



Outdoor Unit	Power Supply				Compressor		OFM	
	Hz - VOLTS	VOLTAGE RANGE	MCA	MOCP	MSC	RLA	W	FLA
2MX18AXVJU	60 - 208	Min. 187 V	10.9	15	9.5	9.5	64	0.44
	60 - 230	Max. 253 V						

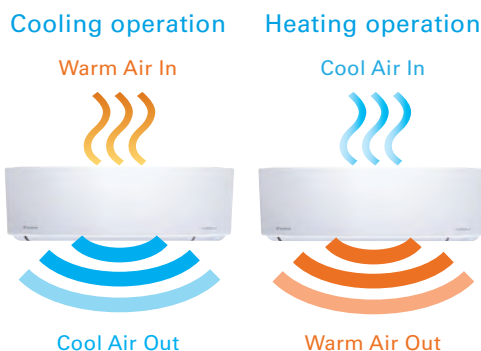

## IDEAL SOLUTIONS FOR:

- » Multiple zones
- » Primary living areas (master bedrooms and living rooms)



**Anti-Corrosion Treatment on Heat Exchanger**



**Quick Warming Function** – Preheats the compressor to shorten the time required to discharge warm air.



**Automatic Defrosting** – Sensor performs automatic defrosting of the outdoor heat exchanger if necessary, ensuring optimum heating performance.



**ECO+** – An intelligent feature that ensures optimum energy consumption while fulfilling basic human comfort needs. Once activated, set temperature will be adjusted automatically to an optimum energy consumption level.



**Blue Fin Protection** – The hydrophilic coated fin ensures the condensate water moves easily to the drain pan — thus enhancing the cleanliness and lifespan of the cooling coil.



**Simplified Maintenance** – The indoor unit has been re-designed for easier removal of the drain pan, blower wheel, and indoor fan motor (compared to other wall-mounted units).

Reduced size and footprint compared to other Daikin Multi-Zone outdoor units.

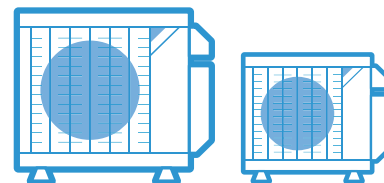

Daikin 2MXS

Daikin CIRRRA

Outdoor Unit Dimensions (HxWxD)	
Daikin CIRRRA	21-11/16 x 26-1/2 x 11-3/16
Daikin 2MXS	28-15/16 x 34-1/4 x 12-5/8

# Multi-Zone Systems

## Daikin *CIRRA*

17 SEER2 | 9 HSPF2 | 10 EER2



Model			CTX07AXVJU		CTX09AXVJU		CTX12AXVJU	
			Cooling	Heating	Cooling	Heating	Cooling	Heating
Nominal Capacity			7 kBtu/h Class		9 kBtu/h Class		12 kBtu/h Class	
Front Panel Color			White		White		White	
Airflow Rate	H	cfm (m3/min)	310 (8.7)	310 (8.7)	350 (9.9)	350 (9.9)	430 (12.2)	430 (12.2)
	M		280 (7.9)	280 (7.9)	300(4.5)	300(4.5)	340 (9.6)	340 (9.6)
	L		249 (7.0)	249 (7.0)	249(7.1)	249(7.1)	249 (7.1)	249 (7.1)
	SL		142 (4.02)	195 (5.5)	142 (4.02)	195 (5.5)	142 (4.02)	195 (5.5)
Fan	Motor Output	W	53					
	Speed	Steps	3 Steps, Quiet, Auto					
Air Direction Control			Right, Left, Horizontal, Downward					
Air Filter			Removable, Washable					
Power Consumption (Rated)		W	38					
Dimensions (H x W x D)		in. (mm)	11-1/3 x 30-29/32 x 9-27/32 (288 x 785 x 250)					
Weight (Mass)		lbs. (kg)	20 (9)					
Sound Pressure Level	H / M / L / SL	dB(A)	37 / 33 / 30 / 19	36 / 32 / 29 / 24	42 / 36 / 30 / 19	41 / 35 / 29 / 24	46 / 39 / 30 / 19	45 / 38 / 29 / 24
Piping Connections	Liquid	in.(mm)	Ø 1/4 (Ø 6.4)					
	Gas		Ø 3/8 (Ø 9.5)					
	Drain		Ø 3/4 (Ø 19)					

Model			2MX18AXVJU	
			Cooling	Heating
Capacity Rated			kW	
			17,000	17,000
COP Rated (Min. - Max.)			—	
			10	3.5
EER2 Rated (Min. - Max.)			—	
			10	9
SEER2 / HSPF2			9	
Compressor	Motor Output	W		
Refrigerant	Type	R-410A		
	Charge	lbs. (kg)	2.65 (1.2)	
Airflow Rate	H	cfm (m³/min)	1170 (33.1)	1,300 (36.8)
Fan	Motor Output	W	25	
	Running Current	A	0.37	0.44
	Power Consumption	W	51	64
Starting Current			A	
			9.5	
Dimension (H x W x D)		in. (mm)	21-11/16 x 26-1/2 x 11-3/16 (550 x 675 x 284)	
Weight		lbs. (kg)	77 (35)	
Sound Pressure Level		dB(A)	50	51
Piping Connections	Liquid	in. (mm)	Ø 1/4 (Ø 6.4)	
	Gas		Ø 3/8 (Ø 9.5)	
	Drain			
Max. Interunit Piping Length		ft. (m)	98-1/2 (30) (for Total of Each Room) 82 (25) (for One Room)	
Amount of Additional Charge of Refrigerant		oz/ft (g/m)	0	
Max. Installation Height Difference		ft. (m)	49-1/4 (15) (between Indoor Unit and Outdoor Unit) 24-5/8 (7.5) (between Indoor Units)	
Operating Range - Cooling		°F DB	50° - 115 °F	
Operating Range - Heating		°F WB	5° - 65 °F	

MULTI-ZONE SYSTEMS

# Multi-Zone Systems OUTDOOR UNITS

## Daikin RMXS\_LVJU and BPMKS\_A

Up to 18.8 SEER | Up to 11.3 HSPF

COMFORTABLE LIMITED  
WARRANTY\* PROTECTION



\* Complete warranty details available from your local dealer/contractor or at [www.daikincomfort.com](http://www.daikincomfort.com). To receive the 12-Year Parts Limited Warranty, online registration must be completed within 60 days of installation. Online registration is not required in California or Québec. The duration of warranty coverages in Texas differs in some cases. *If product installed in a commercial application, limited warranty period is 5 years.*

The 8-Zone Multi-Zone system is the ultimate, flexible solution for individual zone comfort. Connecting up to eight indoor units to a single outdoor unit reduces installation space and costs while maximizing comfort and energy savings. With a choice of six indoor unit types in a wide range of capacities, the 8-Zone Multi-Zone allows mixed and matched combinations for absolute comfort in almost any residential or light commercial application.

### Standard Features

- » Multi-Zone comfort: one outdoor unit connects up to eight separate units
- » Energy Efficient – up to 18.8 SEER, up to 11.3 HSPF, up to 10.3 EER
- » Cooling Range 23° - 115°F
- » Heating Range 5° - 60°F
- » Up to 130% connection ratio
- » Long piping lengths up to 633 ft. total
- » Spacing-saving design

Part Number	Optional Accessories for Outdoor Unit
KKPJ5F180	Drain plug
KHRP26A22T	REFNET joint

### Space Saving Design

- » More than 60% in physical space savings versus a traditional cube style outdoor unit
- » More than 80% in total (including clearances) space savings versus a traditional cube style outdoor unit

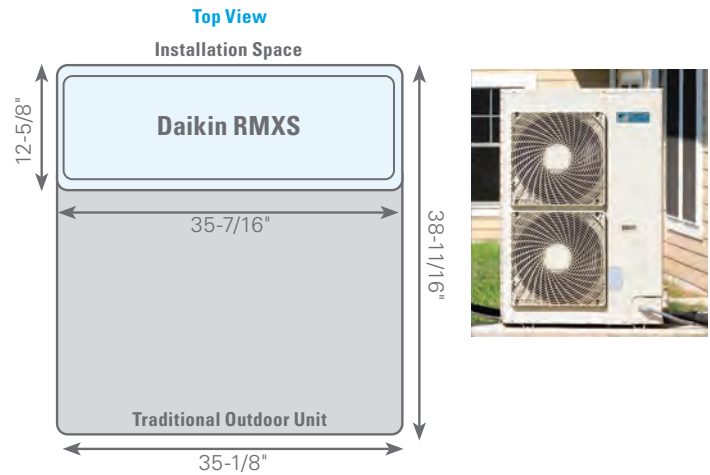

# Multi-Zone Systems OUTDOOR UNITS

## Daikin RMXS\_LVJU and BPMKS\_A

Up to 18.8 SEER | Up to 11.3 HSPF

MULTI-ZONE SYSTEMS

### Longer Refrigerant Piping

Longer refrigerant piping capabilities offers much more flexibility in the choice of installation positions for the indoor units, and greatly simplifies system layout.

Piping Requirements			Allowable Length Details	
Maximum allowable length	Between outdoor and BP units	Total piping length	Piping length between outdoor and BP units ≤ 180 ft (55 m) - [Example] a+b+c+d+e ≤ 180 ft	
	Between BP and indoor units		Piping length between BP and indoor units: 262 ft (80 m) - [Example] f+g+h+i+j+k+l ≤ 262ft	
	Between BP and indoor unit	1 room length	Piping length between BP and indoor unit ≤ 49 ft (15 m) - [Example] f, g, h, i, j, k, l ≤ 49 ft	
Allowable height	Between outdoor and indoor units	Difference in height	Difference in height between outdoor and indoor units (H1) ≤ 98 ft (30 m)	
	Between outdoor and BP units		Difference in height between outdoor and BP units (H2) ≤ 98 ft (30 m)	
	Between BP and BP units		Difference in height between BP and BP units (H3) ≤ 49 ft (15 m)	
	Between indoor and indoor units		Difference in height between indoor and indoor units (H4) ≤ 49 ft (15 m)	
Minimum allowable length		Piping length	Pipe length between outdoor unit and first refrigerant branch kit (REFNET joint) ≥ 16.4 ft [Example] a ≥ 16.4 ft	
Allowable length after the REFNET branch			Piping length from first refrigerant branch kit (REFNET joint) to indoor unit ≤ 131 ft (40 m) [Example] unit 6: b+c+k ≤ 131 ft [Example] unit 5: b+e+j ≤ 131 ft [Example] unit 3: d+h ≤ 131 ft	
Additional refrigerant calculation			$R = \left( \begin{array}{l} \text{Total length (ft/m)} \\ \text{of liquid piping size at} \\ \text{Ø 3/8 inch (Ø 9.5 mm)} \end{array} \right) \times \begin{array}{l} 0.036 \text{ lb./ft} \\ (0.054 \text{ kg/m}) \end{array} + \left( \begin{array}{l} \text{Total length (ft/m)} \\ \text{of liquid piping size at} \\ \text{Ø 1/4 inch (Ø 6.4 mm)} \end{array} \right)$	

### BPMKS

- » Branch Provider Unit
- » Varies the refrigerant volume to meet the cooling or heating requirements of each room connected to the system.
- » Facilitates zone on/off and capacity control to operate rooms individually via zone temperature controls
- » Simple installation with flare nut connections

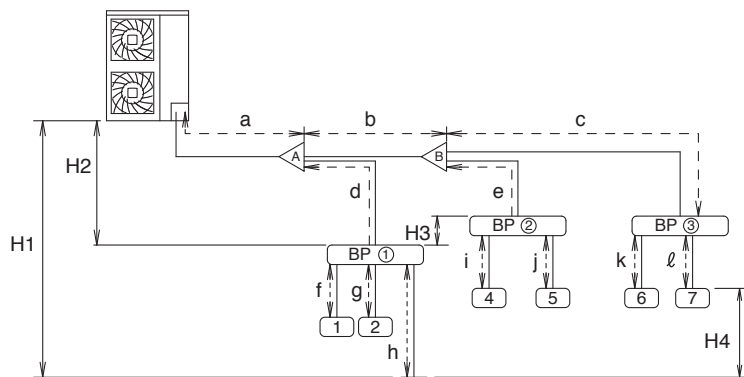
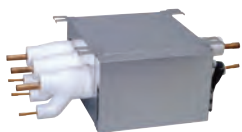

### REFNET joint

- » Reduces the amount of work involved in installation and increases the reliability of the system.





# Multi-Zone Systems

## OUTDOOR UNITS

### Daikin RMXS\_LVJU and BPMKS\_A

Up to 18.8 SEER | Up to 11.3 HSPF

Model		RMXS48LVJU	
		Cooling	Heating
Capacity	Btu/h	48,000	54,000
COP Rated*		3.9	
EER Rated		See Performance Table below	
SEER / HSPF			
Compressor	Motor Output	3	
Refrigerant	Type	R-410A	
	Charge	lbs. (kg)	8.8 (4.0)
Fan	Motor Output	0.070 x 2	
	Airflow rate	cfm	3740
Dimension (H x W x D)		in. (mm)	52-15/16 x 35-7/16 x 12-5/8 (1,345 x 900 x 320)
Weight		lbs. (kg)	283 (129)
Piping Connections	Liquid	in. (mm)	3/8 (9.5) C1220T (Flare Connection)
	Gas	in. (mm)	3/4 (19.1) C1220T (Brazing Connection)
Operating Range - Cooling		°F DB	23° - 115°F
Operating Range - Heating		°F WB	5° - 60°F

\* With non-ducted indoor units



Model		BPMKS048A2U	BPMKS049A3U
Power Consumption	W	10	10
Running Current	A	0.05	0.05
Refrigerant Type		R-410A	
Heat insulation		Both Liquid and Gas Pipes	
Min. Combination		7,000	
Max. Combination		48,000	62,000
Dimension (H x W x D)		in. (mm)	7-1/16 x 11-9/16 [26-11/16]* 13-3/4 (180 x 294 [678])* x 350
Weight		lbs. (kg)	18 (8)   20 (9)
Piping Connections	Liquid	O.U. side	Ø 3/8 (Ø 9.5) x 1
		I.U. side	Ø 1/4 (Ø 6.4) x 2   Ø 1/4 (Ø 6.4) x 3
	Gas	O.U. side	Ø 5/8 (Ø 15.9) x 1
		I.U. side	Ø 5/8 (Ø 15.9) x 2   Ø 5/8 (Ø 15.9) x 3

[ ]\* :including auxiliary piping length

Unit Combination	Outdoor Unit	Hz - Volts	Power Supply				Compressor		OFM		
			Voltage Range	Min	Max	MCA	MOCP	MSC	RLA	W	FLA
RMXS48LVJU		60	208	187	229	27.0	30	23.7	22.7	70 x 2	0.3 x 2
			230	207	253			21.5	20.5	70 x 2	0.3 x 2

MXS series Performance		SEER	EER	HSPF
RMXS48LVJU	Non-Ducted	18.8	10.3	11.3
	Ducted	14.1	9.3	9.6
	Mixed	16.45	9.8	10.45

### Simplified Electrical Wiring

The outdoor unit and BP units operate from separate 208/230V single-phase power supplies. Indoor units are powered from the BP unit and wired as Daikin's current 4 wire single split systems reducing the wiring size and easing installation

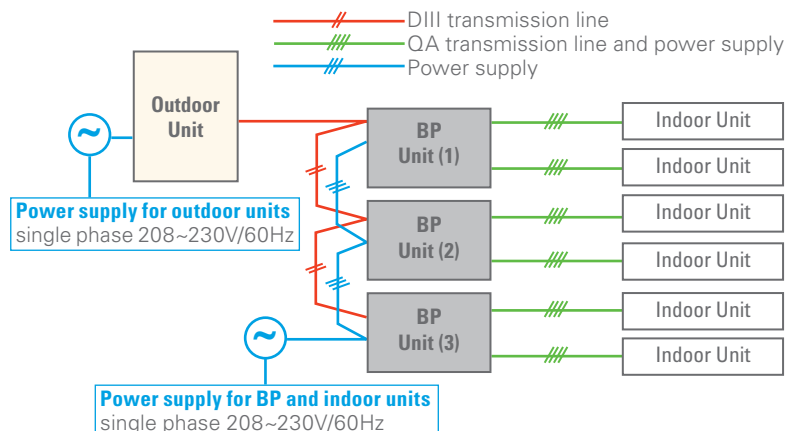







# Multi-Zone Systems

## INDOOR UNITS

### Daikin *EMURA* Wall-Mounted

#### FTXR\_WVJU(W/S)9

COMFORTABLE LIMITED  
WARRANTY\* PROTECTION



\* Complete warranty details available from your local dealer/contractor or at [www.daikincomfort.com](http://www.daikincomfort.com). To receive the 12-Year Parts Limited Warranty, online registration must be completed within 60 days of installation. Online registration is not required in California or Québec. The duration of warranty coverages in Texas differs in some cases.  
*If product installed in a commercial application, limited warranty period is 5 years.*

The Daikin *EMURA* wall-mounted units, are the next generation of home air conditioning is available for Multi-Zone combinations, offering smart technology within a sleek, curved silhouette. Daikin *EMURA* is designed to satisfy a uniquely “Designer” sense of style.

Offering sophisticated solutions for contemporary interiors, the new Daikin *EMURA* combines form and functionality to create an icon of contemporary climate control. Available in silver or pure matte white, Daikin *EMURA* makes a modern design statement on any wall.

#### Standard Features

- » Indoor Sound Pressure as low as 19\* dB(A)
- » 2-Area Intelligent Eye
- » Power airflow dual flaps and 3-D Airflow
- » Titanium Apatite Photocatalytic Air Purifying Filter
- » Weekly Timer
- » Program Dry Function
- » Econo Mode
- » Comfort Mode
- » Powerful Operation Mode
- » Backlit Wireless Remote Controller
- \*On SL fan speed

#### Optional Features

- » Wired controller
- » Compatible with Daikin *One+* Smart Thermostat, DKN Residential Cloud Wi-Fi Adaptor, or DKN Plus Interface

Part Number	Optional Accessories for Outdoor Unit
BRC944B2-A08	Wired Remote Controller kit
DACA-BRCW901P10	Remote Controller Cable, Plenum Rated, 10 ft (For BRC944B2)
DACA-BRCW901P25	Remote Controller Cable, Plenum Rated, 25 ft (For BRC944B2)
DTST-ONE-ADA-A	Daikin <i>One+</i> Smart Thermostat
AZAI6WSCDKB	DKN Residential Cloud Wi-Fi Adaptor
AZAI6WSPDKC	Daikin DKN Plus Interface
DACA-CP1-1	Condensate Pump (Fits inside all Daikin indoor unit heads - 33 ft head - 22dB)
KAF970A46	07, 15, 18 Class Air-purifying filter with photocatalytic deodorizing function (without frame)
KRP928BB2S	Interface adaptor for DIII-NET



#### IDEAL SOLUTIONS FOR:

- » Renovations, remodeling and new construction
- » Sun rooms, basements, garages, hot or cold rooms, attics where the walls tend to be lower, or wherever wall space is at a premium
- » Ceiling void or attic does not allow for a viable duct run option
- » Homeowners desiring advanced features for comfort, savings, and a “Designer” sense of style



**3-D Airflow** – Combines vertical and horizontal auto-swing to circulate cool/warm air to the corners of large spaces.



**Comfort Mode** – Comfort Mode operation improves comfort. When cooling, the flap positions itself horizontally to prevent cold airflow from being blown directly onto the body. When heating, the flap turns vertically downwards to drive warm air to the bottom of the room.



**2-Area Intelligent Eye** – The two-area intelligent eye sensor controls comfort in two ways. If the room is empty for 20 minutes, it changes the set point to start saving energy. As soon as someone enters the room, it immediately returns to the original setting. The intelligent eye also directs air flow away from people in the room to avoid cold drafts.



**Titanium Apatite Photocatalytic Air Purifying Filter** – (Option) This filter combines the air-purifying filter and titanium apatite photocatalytic deodorizing filter in a single highly effective unit.



**Night Set Mode** – Rapid changes in room temperature can disturb your sleep. To avoid this, Daikin *EMURA* prevents overheating or over-cooling during the night. If the timer is switched on, the unit will automatically set the temperature to 3°F warmer.



**Auto-Restart** – The unit memorizes the operation mode, airflow and temperature settings. Should there be a power failure when the unit is in operation, it will automatically return to the same operating conditions when the power is restored.

# Multi-Zone Systems INDOOR UNITS

## Daikin *EMURA* Wall-Mounted FTXR\_WVJU(W/S)9

Pure matte white finish



Silver finish



Wireless I/R controller



Model			FTXR09WVJUW9 (White) FTXR09WVJUS9 (Silver)		FTXR12WVJUW9 (White) FTXR12WVJUS9 (Silver)		FTXR18WVJUW9 (White) FTXR18WVJUS9 (Silver)	
			Cooling	Heating	Cooling	Heating	Cooling	Heating
Nominal Capacity			9 kBtu/h Class		12 kBtu/h Class		18 kBtu/h Class	
Front Panel Color			White or Silver		White or Silver		White or Silver	
Airflow Rate	H	cfm (m3/min)	272 (7.7)	346 (9.8)	335 (9.5)	395 (11.2)	350(9.9)	413 (11.7)
	M		208 (5.9)	258 (7.3)	219 (6.2)	290 (8.2)	275 (7.8)	332 (9.4)
	L		162 (4.6)	201 (5.7)	169 (4.8)	226 (6.4)	226 (6.4)	275 (7.8)
	SL		134 (3.8)	117 (3.3)	131 (3.7)	131 (3.7)	208 (5.9)	208 (5.9)
Fan	Motor Output	W	29					
	Speed	Steps	5 Steps, Quiet, Auto					
Air Direction Control			Right, Left, Horizontal, Downward					
Air Filter			Removable, Washable					
Power Consumption (Rated)		W	13	26	26	38	28	42
Dimensions (H x W x D)		in. (mm)	11-15/16 x 39-5/16 x 8-3/8 (303 x 998 x 212)					
Weight (Mass)		lbs. (kg)	27 (12)					
Sound Pressure Level	H / M / L / SL	dB(A)	38 / 32 / 25 / 19	41 / 34 / 28 / 19	45 / 34 / 26 / 20	45 / 37 / 29 / 20	46 / 40 / 35 / 30	47 / 41 / 35 / 30
Piping Connections	Liquid	in.(mm)	Ø 1/4 (Ø 6.4)					
	Gas		Ø 3/8 (Ø 9.5)			Ø 1/2 (Ø 12.7)		
	Drain		Ø 11/16 (Ø 18)					

# Multi-Zone Systems

## INDOOR UNITS

### Wall-Mounted

CTXS07WVJU9 and FTXS\_WVJU9

COMFORTABLE LIMITED WARRANTY\* PROTECTION



\* Complete warranty details available from your local dealer/contractor or at [www.daikincomfort.com](http://www.daikincomfort.com). To receive the 12-Year Parts Limited Warranty, online registration must be completed within 60 days of installation. Online registration is not required in California or Québec. The duration of warranty coverages in Texas differs in some cases. *If product installed in a commercial application, limited warranty period is 5 years.*

CTXS/FTXS series is a feature-packed, intelligent wall-mounted system that includes intelligent eye for energy savings and horizontal auto swing outlet fins for 3-D airflow comfort.

#### Standard Features

- » Indoor Sound Pressure as low as 22\* dB(A)
  - » Intelligent Eye
  - » Power airflow dual flaps and 3-D Airflow
  - » Titanium Apatite Photocatalytic Air Purifying Filter
  - » Weekly Timer
  - » Program Dry Function
  - » Econo Mode
  - » Powerful Operation Mode
  - » Backlit Wireless Remote Controller
  - » Auto-Changeover
  - » Auto-Fan Speed Control
- \*On SL fan speed

#### Optional Features

- » Wired controller
- » Compatible with Daikin *One+* Smart Thermostat, DKN Residential Cloud Wi-Fi Adaptor, or DKN Plus Interface

Part Number	Optional Accessories for Outdoor Unit
BRC944B2-A08	Wired Remote Controller kit
DACA-BRCW901P10	Remote Controller Cable, Plenum Rated, 10 ft (For BRC944B2)
DACA-BRCW901P25	Remote Controller Cable, Plenum Rated, 25 ft (For BRC944B2)
DTST-ONE-ADA-A	Daikin <i>One+</i> Smart Thermostat
AZAI6WSCDKB	DKN Residential Cloud Wi-Fi Adaptor
AZAI6WSPDKC	Daikin DKN Plus Interface
DACA-CP1-1	Condensate Pump (Fits inside all Daikin indoor unit heads - 33 ft head - 22dB)
DACA-CP2-1	Condensate Pump (Higher ft head needs - 50 ft head - 38db)
DACA-CP3-1	Condensate Pump (Will not fit in certain unit size heads - 33 ft head - 22dB)
KAF952A42	09, 12 Class Air-purifying filter with photocatalytic deodorizing function (without frame)
KAF970A46	07, 15, 18 Class Air-purifying filter with photocatalytic deodorizing function (without frame)
KRP928BB2S	Interface adaptor for DIII-NET



#### IDEAL SOLUTIONS FOR:

- » Renovations, remodeling and new construction
- » Sun rooms, basements, garages, hot or cold rooms, attics where the walls tend to be lower, or wherever wall space is at a premium
- » Ceiling void or attic does not allow for a viable duct run option
- » Homeowners desiring advanced features for comfort and savings



**3-D Airflow** – Combines vertical and horizontal auto-swing to circulate cool/warm air to the corners of large spaces.



**Intelligent Eye** – The intelligent eye is an infrared sensor with the ability to sense movement in the room. When you are in the room, the air conditioner operates normally. If you leave the room for more than 20 minutes the air conditioner automatically changes to an energy-saving operation. Using the intelligent eye, savings of up to 20% in cooling and up to 30% in heating can be achieved compared to units without this feature.



**Hot Start** – (Heat Pump) When the heating operation starts or when the unit changes from cooling to heating, there is no cold draft.



**Titanium Apatite Photocatalytic Air Purifying Filter** – This filter combines the air-purifying filter and titanium apatite photocatalytic deodorizing filter in a single highly effective unit.



**Auto-Restart** – The unit memorizes the operation mode, airflow and temperature settings. Should there be a power failure when the unit is in operation, it will automatically return to the same operating conditions when the power is restored.



**Powerful Operation Mode** – Pushing the POWERFUL button on the remote control gives you a boost in cooling or heating power for a 20-minute period, even if the unit is already operating at high capacity.



# Multi-Zone Systems

## INDOOR UNITS

### Wall-Mounted

CTXS07WVJU9 and FTXS\_WVJU9



MULTI-ZONE SYSTEMS

Model			CTXS07WVJU9		FTXS09WVJU9		FTXS12WVJU9	
			Cooling	Heating	Cooling	Heating	Cooling	Heating
Nominal Capacity			7 kBtu/h Class		9 kBtu/h Class		12 kBtu/h Class	
Front Panel Color			White					
Airflow Rate	H	cfm (m <sup>3</sup> /min)	332 (9.4)	350 (9.9)	381 (10.8)	420 (11.9)	403 (11.4)	438 (12.4)
	M		261 (7.4)	290 (8.2)	279 (7.9)	321 (9.1)	307 (8.7)	335 (9.5)
	L		194 (5.5)	233 (6.6)	194 (5.5)	233 (6.6)	205 (5.8)	240 (6.8)
	SL		145 (4.1)	219 (6.2)	145 (4.1)	219 (6.2)	155 (4.4)	212 (6.0)
Fan	Motor Output	HP	0.03					
	Speed	Steps	5 Steps, Quiet, Auto					
Air Direction Control			Right, Left, Horizontal, Downward					
Air Filter			Removable, Washable					
Power Consumption (Rated)		W	18	21	18	21	26	28
Dimensions (H x W x D)		in. (mm)	11-5/8 x 31-1/2 x 8-7/16 (295 x 800 x 215)					
Weight (Mass)		lbs. (kg)	20 (9)				22 (10)	
Sound Pressure Level	H / M / L / SL	dB(A)	38 / 32 / 25 / 22	38 / 33 / 28 / 25	41 / 33 / 25 / 22	42 / 35 / 28 / 25	45 / 37 / 29 / 23	45 / 39 / 29 / 26
	Liquid		in. (mm)	Ø 1/4 (6.4)				
Piping Connections	Gas	in. (mm)	Ø 3/8 (9.5)					
	Drain	in. (mm)	Ø 5/8 (16.0)					

Model			FTXS15WVJU9		FTXS18WVJU9		FTXS24WVJU9	
			Cooling	Heating	Cooling	Heating	Cooling	Heating
Nominal Capacity			15 kBtu/h Class		18 kBtu/h Class		24 kBtu/h Class	
Front Panel Color			White					
Airflow Rate	H	cfm (m <sup>3</sup> /min)	568 (16.1)	593 (16.8)	583 (16.5)	625 (17.7)	643 (18.2)	699 (19.8)
	M		477 (13.5)	505 (14.3)	484 (13.7)	526 (14.9)	494 (14.0)	572 (16.2)
	L		385 (10.9)	417 (11.8)	385 (10.9)	431 (12.2)	350 (9.9)	445 (12.6)
	SL		360 (10.2)	371 (10.5)	360 (10.2)	399 (11.3)	328 (9.3)	403 (11.4)
Fan	Motor Output	HP	0.06					
	Speed	Steps	5 Steps, Quiet, Auto					
Air Direction Control			Right, Left, Horizontal, Downward					
Air Filter			Removable, Washable					
Power Consumption (Rated)		W	38 - 38				69 - 68	
Dimensions (H x W x D)		in. (mm)	13-3/8 x 41-5/16 x 9-3/4 (340 x 1,050 x 248)					
Weight (Mass)		lbs. (kg)	31 (14)					
Sound Pressure Level	H / M / L / SL	dB(A)	45 / 40 / 35 / 32	43 / 38 / 33 / 30	46 / 41 / 36 / 33	45 / 40 / 35 / 32	51 / 44 / 37 / 34	48 / 42 / 37 / 34
	Liquid		in. (mm)	Ø 1/4 (6.4)				
Piping Connections	Gas	in. (mm)	Ø 1/2 (12.7)				Ø 5/8 (15.9)	
	Drain	in. (mm)	Ø 5/8 (16)					

# Multi-Zone Systems

## INDOOR UNITS

### Slim Ducted

FDXS\_LVJU and CDXS

## COMFORTABLE LIMITED WARRANTY\* PROTECTION



\* Complete warranty details available from your local dealer/contractor or at [www.daikincomfort.com](http://www.daikincomfort.com). To receive the 12-Year Parts Limited Warranty, online registration must be completed within 60 days of installation. Online registration is not required in California or Québec. The duration of warranty coverages in Texas differs in some cases. *If product installed in a commercial application, limited warranty period is 5 years.*

A slim-ducted concealed ceiling unit provides an extremely unobtrusive, compact solution, where only the discharge and intake grilles are visible. In addition, they free up floor and wall space to minimize the impact on decor.

### Standard Features

- » Indoor Sound Pressure as low as 31 dB(A)
- » Program Dry Function
- » Econo Mode
- » Powerful Operation Mode
- » Backlit Wireless Remote Controller
- » Auto-Changeover
- » Auto-Fan Speed Control
- » Self-Diagnostics with Digital Display

### Optional Features

- » Wired controller
- » Compatible with Daikin *One+* Smart Thermostat, DKN Residential Cloud Wi-Fi Adaptor, or DKN Plus Interface

### IDEAL SOLUTIONS FOR:

- » Renovations, remodeling and new construction
- » Sun rooms, basements, garages, hot or cold rooms, attics where the walls tend to be lower, or wherever wall space is at a premium
- » Ceiling void or attic does not allow for a viable standard ducted solution
- » Homeowners' reluctance to use a visible wall or a floor mounted unit



**Hot Start** – (Heat Pump) When the heating operation starts or when the unit changes from cooling to heating, there is no cold draft.



**Powerful Operation Mode** – Pushing the POWERFUL button on the remote control gives you a boost in cooling or heating power for a 20-minute period, even if the unit is already operating at high capacity.

Part Number	Optional Accessories for Outdoor Unit
BRC944B2-A08	Wired Remote Controller kit
DACA-BRCW901P10	Remote Controller Cable, Plenum Rated, 10 ft (For BRC944B2)
DACA-BRCW901P25	Remote Controller Cable, Plenum Rated, 25 ft (For BRC944B2)
DTST-ONE-ADA-A	Daikin <i>One+</i> Smart Thermostat
AZAI6WSCDKB	DKN Residential Cloud Wi-Fi Adaptor
AZAI6WSPDKC	Daikin DKN Plus Interface
DACA-CP1-1	Condensate Pump (33 ft head - 22dB)
DACA-CP2-1	Condensate Pump (Higher ft head needs - 50 ft head - 38db)
DACA-CP3-1	Condensate Pump ( 33 ft head - 22dB)
KRP928BB2S	Interface adaptor for DIII-NET
DACA-ARCW901P10	IR Receiver Box Cable, Plenum Rated, 10ft
DACA-ARCW901P25	IR Receiver Box Cable, Plenum Rated, 25ft
KDT25N32	09, 12 Class Insulation kit for high humidity
KDT25N50	15, 18 Class Insulation kit for high humidity



Note: FDXS and CDXS indoor units are now only rated with RMXS48LVJU

# Multi-Zone Systems

## INDOOR UNITS

### Slim Ducted

FDXS\_LVJU and CDXS

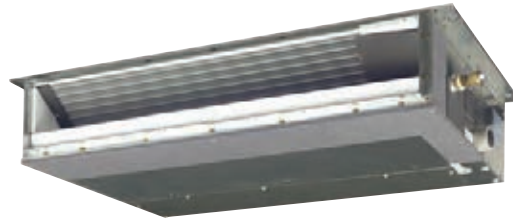

MULTI-ZONE SYSTEMS

Model			CDXS07LVJU		FDXS09LVJU		FDXS12LVJU	
			Cooling	Heating	Cooling	Heating	Cooling	Heating
Nominal Capacity			7 kBtu/h Class		9 kBtu/h Class		12 kBtu/h Class	
External Static Pressure		inAq (Pa)	0.12 (30)		0.12 (30)		0.12 (30)	
Airflow Rate	H	cfm (m <sup>3</sup> /min)	305 (8.6)	305 (8.6)	305 (8.6)	305 (8.6)	305 (8.6)	305 (8.6)
	M		280 (7.9)	280 (7.9)	280 (7.9)	280 (7.9)	280 (7.9)	280 (7.9)
	L		260 (7.4)	260 (7.4)	260 (7.4)	260 (7.4)	260 (7.4)	260 (7.4)
	SL		235 (6.7)	235 (6.7)	235 (6.7)	235 (6.7)	235 (6.7)	235 (6.7)
Fan	Motor Output	W	62					
	Speed	Steps	5 Steps, Quiet, Auto					
Air Filter			Removable, Washable					
Power Consumption (Rated)		W	72					
Dimensions (H x W x D)		in. (mm)	7-7/8 x 27-9/16 x 24-7/16 (200 x 700 x 620)					
Weight (Mass)		lbs. (kg)	47 (21)					
Sound Pressure Level	H / M / L	dB(A)	35 / 33 / 31					
	Liquid		Ø 1/4 (Ø 6.4)					
Piping Connections	Gas	in. (mm)	Ø 3/8 (Ø 9.5)					
	Drain		Ø 25/32 (Ø 20)					

Model			CDXS15LVJU		CDXS18LVJU		CDXS24LVJU	
			Cooling	Heating	Cooling	Heating	Cooling	Heating
Nominal Capacity			15 kBtu/h Class		18 kBtu/h Class		24 kBtu/h Class	
External Static Pressure		inAq (Pa)	0.16 (40)		0.16 (40)		0.16 (40)	
Airflow Rate	H	cfm (m <sup>3</sup> /min)	424 (12.0)	424 (12.0)	424 (12.0)	424 (12.0)	565 (16)	565 (16)
	M		388 (11.0)	388 (11.0)	388 (11.0)	388 (11.0)	523 (14.8)	523 (14.8)
	L		353 (10.0)	353 (10.0)	353 (10.0)	353 (10.0)	477 (13.5)	477 (13.5)
	SL		297 (8.4)	297 (8.4)	297 (8.4)	297 (8.4)	395 (11.2)	395 (11.2)
Fan	Motor Output	W	130					
	Speed	Steps	5 Steps, Quiet, Auto					
Air Filter			Removable, Washable					
Power Consumption (Rated)		W	172		160			
Dimensions (H x W x D)		in. (mm)	7-7/8 x 35-7/16 x 24-7/16 (200 x 900 x 620)		7-7/8 x 43-5/16 x 24-7/16 (200 x 1,100 x 620)			
Weight		lbs. (kg)	60 (27)		66 (30)			
Sound Pressure Level	H / M / L / SL	dB(A)	37 / 35 / 33 / 31		38/36/34/32			
	Liquid		Ø 1/4 (Ø 6.4)					
Piping Connections	Gas	in. (mm)	Ø 1/2 (Ø 12.7)		Ø 5/8 (Ø 15.8)			
	Drain		Ø 1-1/32 (Ø 26) Ø 25/32 (Ø 20))		Ø 1-1/32 (Ø 26) Ø 25/32 (Ø 20))		Ø 1-1/32 (Ø 26) Ø 25/32 (Ø 20))	

# Multi-Zone Systems

## INDOOR UNITS

### Ducted Concealed

CDMQ07WVJU9 and FDMQ\_WVJU9

COMFORTABLE LIMITED WARRANTY\* PROTECTION



\* Complete warranty details available from your local dealer/contractor or at [www.daikincomfort.com](http://www.daikincomfort.com). To receive the 12-Year Parts Limited Warranty, online registration must be completed within 60 days of installation. Online registration is not required in California or Québec. The duration of warranty coverages in Texas differs in some cases. *If product installed in a commercial application, limited warranty period is 5 years.*

A ducted concealed ceiling unit provides a completely concealed installation, minimizing the impact on decor. Easily incorporate longer duct runs and MERV filters with available external static pressures of up to 0.6.

#### Standard Features

- » Indoor Sound Pressure as low as 32 dB(A)
- » Auto-Fan Speed control ( with wired controller)
- » No optional adaptor needed for DIII-connection, link your unit into the wider building management system
- » Self-Diagnostics with digital display
- » Drain Pan Inspection Port
- » Integral lift mechanism
- » Compatible with Daikin *One+* Smart Thermostat, DKN Cloud Wi-Fi Adaptor, or Daikin DKN Plus Interface

Part Number	Optional Accessories for Outdoor Unit
BRC1E73	Wired Remote Controller
KRCS01-4B	Remote Sensor
BRC082A43	Wireless handheld controller (sensor included)
AZAI6WSCDKA	DKN Cloud Wi-Fi Adaptor
DTST-ONE-ADA-A	Daikin <i>One+</i> Smart Thermostat
AZAI6WSPDKC	Daikin DKN Plus Interface
KRCHS2018-01	Button Sensor Kit
BRC1H71W	<i>Madoka</i> Remote Controller
DFBS27A13	MERV 13 Filter Kit for FDMQ 09 & 12
DFBS39A13	MERV 13 Filter Kit for FDMQ 15, 18 & 24

#### IDEAL SOLUTIONS FOR:

- » Renovations, remodeling and new construction
- » Sun rooms, basements, garages, hot or cold rooms, attics where the walls tend to be lower, or wherever wall space is at a premium
- » Ceiling void or attics which allow for a ducted solution with longer duct runs
- » Homeowners requiring higher level of filtration
- » Homeowners' reluctance to use a visible wall or a floor mounted unit



**Program dry function** – This gives priority to reducing the level of humidity in the room rather than room temperature.



**Hot Start** – (Heat Pump) When the heating operation starts or when the unit changes from cooling to heating, there is no cold draft.

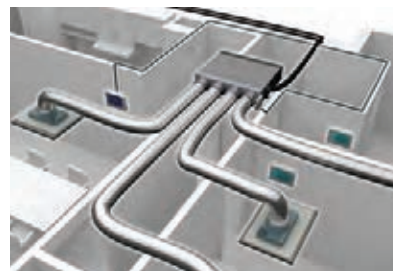

- » Increases the flexibility of the FDMQ systems in both residential and commercial applications by adding a Zoning Box to an indoor unit fan coil
- » Allows several separate ducts to supply air to different individually-controlled zones.
- » The DZK BACnet™ Interface will work with any BACnet/IP compatible Building Management System



Wired\* Thermostat



Wireless\* Thermostat  
\*for DZK Kit



Wireless Lite\* Thermostat



# Multi-Zone Systems INDOOR UNITS Ducted Concealed CDMQ07WVJU9 and FDMQ\_WVJU9



Model		FDMQ09WVJU9		FDMQ12WVJU9		FDMQ15WVJU9		
		Cooling	Heating	Cooling	Heating	Cooling	Heating	
Nominal Capacity		9 kBtu/h Class		12 kBtu/h Class		15 kBtu/h Class		
External Static Pressure *		inH2O		0.2(0.6-0.12)				
		Pa		50 (150-30)				
Airflow Rate	H	cfm (m³/min)	293 (8.3)	293 (8.3)	371 (10.5)	371 (10.5)	448 (12.7)	448 (12.7)
	M		265 (7.5)	265 (7.5)	318 (9.0)	318 (9.0)	399 (11.3)	399 (11.3)
	L		233 (6.6)	233 (6.6)	261 (7.4)	261 (7.4)	350 (9.9)	350 (9.9)
	SL		-	-	-	-	-	-
Fan	Motor Output	HP	0.17		0.17		0.31	
	Speed	Steps	-					
Air Filter **		-						
Power Consumption (Rated)		W		-				
Dimensions (H x W x D)		in. (mm)		9-5/8 x 27-9/16 x 31-1/2 (245 x 700 x 800)		9-5/8 x 39-3/8 x 31-1/2 (245 x 1,000 x 800)		
Weight (Mass)		lbs. (kg)		64 (29)		77 (35)		
Sound Pressure Level	H / M / L	dB(A)		32		33		34
Piping Connections	Liquid	in. (mm)		Ø 1/4 (Ø 6.4)				
	Gas			Ø 3/8 (Ø 9.5)				
	Drain			Ø 1 (25.0)				

\* External static pressure is changeable in 13 stages by remote controller

\*\* Air filter is not standard accessory, but please mount it in the duct system of the suction side. Select its dust collection efficiency (gravity method) 50% or more

Model		FDMQ18WVJU9		FDMQ24WVJU9		
		Cooling	Heating	Cooling	Heating	
Nominal Capacity		18 kBtu/h Class		24 kBtu/h Class		
External Static Pressure		inH2O		0.2(0.6-0.12)		
		Pa		50 (150-50)		
Airflow Rate	H	cfm (m³/min)	614 (17.4)	614 (17.4)	731 (20.7)	731 (20.7)
	M		523 (14.8)	523 (14.8)	621 (17.6)	621 (17.6)
	L		431 (12.2)	431 (12.2)	512 (14.5)	512 (14.5)
	SL		-	-	-	-
Fan	Motor Output	HP	0.31			
	Speed	Steps	-			
Air Filter		-				
Power Consumption (Rated)		W		-		
Dimensions (H x W x D)		in. (mm)		9-5/8 x 39-3/8 x 31-1/2 (245 x 1,000 x 800)		
Weight		lbs. (kg)		82 (37)		
Sound Pressure Level	H	dB(A)		35		40
Piping Connections	Liquid	in. (mm)		Ø 1/4 (Ø 6.4)		
	Gas			Ø 1/2 (Ø 12.7)		Ø 5/8 (Ø 15.9)
	Drain			Ø 1 (25.0)		

# Multi-Zone Systems

## INDOOR UNITS

### Floor-Mounted

#### FVXS\_WVJU9

## COMFORTABLE LIMITED WARRANTY\* PROTECTION



\* Complete warranty details available from your local dealer/contractor or at [www.daikincomfort.com](http://www.daikincomfort.com). To receive the 12-Year Parts Limited Warranty, online registration must be completed within 60 days of installation. Online registration is not required in California or Québec. The duration of warranty coverages in Texas differs in some cases.  
If product installed in a commercial application, limited warranty period is 5 years.

Floor-mounted units are simple to install and can be setup in various configurations, on the floor or hanging low on a wall. Its low height enables the unit to fit beneath a window. The airflow distribution pattern of Daikin's floor mounted unit is ideal for heating a space, and is a perfect replacement to traditional radiant systems.

### Standard Features

- » Indoor Sound Pressure as low as 23\* dB(A)
  - » Washable Air Filter
  - » Program Dry Function
  - » Econo Mode
  - » Powerful Operation Mode
  - » Titanium Apatite Photocatalytic Air Purifying Filter
  - » Backlit Wireless Remote Controller
  - » Outdoor Unit Quiet Operation
  - » Auto-Changeover
  - » Auto-Fan Speed Control
  - » Self-Diagnostics with Digital Display
- \*On SL fan speed

### Optional Features

- » Wired controller
- » Compatible with Daikin *One+* Smart Thermostat, DKN Residential Cloud Wi-Fi Adaptor, or DKN Plus Interface

Part Number	Optional Accessories for Outdoor Unit
BRC944B2-A08	Wired Remote Controller kit
DACA-BRCW901P10	Remote Controller Cable, Plenum Rated, 10 ft (For BRC944B2)
DACA-BRCW901P25	Remote Controller Cable, Plenum Rated, 25 ft (For BRC944B2)
DTST-ONE-ADA-A	Daikin <i>One+</i> Smart Thermostat
AZAI6WSCDKB	DKN Residential Cloud Wi-Fi Adaptor
AZAI6WSPDKC	Daikin DKN Plus Interface
DACA-CP1-1	Condensate Pump (Fits inside all Daikin indoor unit heads - 33 ft head - 22dB)
DACA-CP2-1	Condensate Pump (Higher ft head needs - 50 ft head - 38db)
DACA-CP3-1	Condensate Pump (Will not fit in certain unit size heads - 33 ft head - 22dB)
KRP928BB2S	Interface adaptor for DIII-NET
KAF968A42 or KAF968B42	Titanium apatite photocatalytic air-purifying filter (without frame)

### IDEAL SOLUTIONS FOR:

- » Cold regions where homeowners want to enjoy a reliable, energy efficient source of heat
- » Renovations, remodeling and new construction
- » Sun rooms, basements, garages, hot or cold rooms, attics where the walls tend to be lower, or wherever wall space is at a premium
- » Ceiling void or attic does not allow for a viable duct run option



**Auto-Restart** – The unit memorizes the operation mode, airflow and temperature settings. Should there be a power failure when the unit is in operation, it will automatically return to the same operating conditions when the power is restored.



**Titanium Apatite Photocatalytic Air Purifying Filter** – This filter combines the air-purifying filter and titanium apatite photocatalytic deodorizing filter in a single highly effective unit.



**Program dry function** – This gives priority to reducing the level of humidity in the room rather than room temperature.



**Comfort Mode** – Comfort Mode operation improves comfort. When cooling, the flap positions itself horizontally to prevent cold airflow from being blown directly onto the body. When heating, the flap turns vertically downwards to drive warm air to the bottom of the room.



**Hot Start** – (Heat Pump) When the heating operation starts or when the unit changes from cooling to heating, there is no cold draft.



**Powerful Operation Mode** – Pushing the POWERFUL button on the remote control gives you a boost in cooling or heating power for a 20-minute period, even if the unit is already operating at high capacity.



# Multi-Zone Systems

## INDOOR UNITS

### Floor-Mounted

FVXS\_WVJU9



MULTI-ZONE SYSTEMS

Model			FVXS09WVJU9		FVXS12WVJU9		FVXS15WVJU9		FVXS18WVJU9	
			Cooling	Heating	Cooling	Heating	Cooling	Heating	Cooling	Heating
Nominal Capacity			9 kBtu/h Class		12 kBtu/h Class		15 kBtu/h Class		18 kBtu/h Class	
Front Panel Color			White							
Airflow Rate	H	cfm (m <sup>3</sup> /min)	290 (8.2)	311 (8.8)	300 (8.5)	332 (9.4)	378 (10.7)	417 (11.8)	378 (10.7)	417 (11.8)
	M		230 (6.5)	244 (6.9)	237 (6.7)	258 (7.3)	325 (9.2)	357 (10.1)	325 (9.2)	357 (10.1)
	L		169 (4.8)	177 (5.0)	173 (4.9)	184 (5.2)	275 (7.8)	300 (8.5)	275 (7.8)	300 (8.5)
	SL		145 (4.1)	155 (4.4)	159 (4.5)	166 (4.7)	233 (6.6)	251 (7.1)	233 (6.6)	251 (7.1)
Fan	Motor Output	W	0.02			0.03				
	Speed	Steps	5 Steps, Quiet, Auto							
Air Direction Control			Right, Left, Horizontal, Downward							
Air Filter			Removable, Washable							
Power Consumption (Rated)		W	15	17	15	17	27	34 - 34	27	34 - 34
Dimensions (H x W x D)		in. (mm)	23-5/8 x 27-9/16 x 8-1/4 (600 x 700 x 210)							
Weight (Mass)		lbs. (kg)	31 (14)							
Sound Pressure Level	H / M / L / SL	dB(A)	38 / 32 / 26 / 23		39 / 33 / 27 / 24		44 / 40 / 36 / 32	45 / 40 / 36 / 32	44 / 40 / 36 / 32	45 / 40 / 36 / 32
Piping Connections	Liquid	in. (mm)	Ø 1/4 (Ø 6.4)							
	Gas		Ø 3/8 (Ø 9.5)				Ø 1/2 (Ø 12.7)			
	Drain		Ø 13/16 (Ø 20)							

# Multi-Zone Systems

## INDOOR UNITS

### Daikin *VISTA* Ceiling Cassette

FFQ\_W2VJU9

## COMFORTABLE LIMITED WARRANTY\* PROTECTION



\* Complete warranty details available from your local dealer/contractor or at [www.daikincomfort.com](http://www.daikincomfort.com). To receive the 12-Year Parts Limited Warranty, online registration must be completed within 60 days of installation. Online registration is not required in California or Québec. The duration of warranty coverages in Texas differs in some cases.  
If product installed in a commercial application, limited warranty period is 5 years.

The Daikin *VISTA* ceiling cassettes are a remarkable blend of iconic design and engineering excellence with an elegant white or a silver and white finish. Fitting within the ceiling grid and discreetly mounted to the ceiling itself, Daikin *VISTA* is stylish, low profile, and compact. High efficiency and comfort is delivered through the combined use of floor and presence sensors (optional). It is also possible to close individual louvers via the wired remote control for personalized comfort.

### Standard Features

- » Indoor Sound Pressure as low as 29 dB(A)
- » Energy efficient thanks to specially developed small tube heat exchanger, DC fan motor and two optional intelligent sensors
- » No optional adaptor needed for DIII-connection, link your unit into the wider building management system
- » Draft Prevention
- » Program Dry Function
- » Hot Start Function
- » Auto-Fan Speed Control (with wired controller)
- » Self-Diagnostics with Digital Display
- » Schedule TIMER operation (with wired controller)

### Optional Features

- » Wired controller
- » Fresh air integration possible
- » Presence and Floor Sensor
- » Compatible with Daikin *One+* Smart Thermostat, DKN Cloud Wi-Fi adaptor or Daikin DKN Plus Interface.

Part Number	Optional Accessories for Outdoor Unit
BRC1E73	Wired Navigation Remote Controller
AZAI6WSCDKA	DKN Cloud Wi-Fi Adaptor
DTST-ONE-ADA-A	Daikin <i>One+</i> Smart Thermostat
AZAI6WSPDKC	DKN Plus Interface
KRCHS2018-01	Button Sensor Kit
BRC082A42W	Wireless Remote Controller (White)
BRC082A42S	Wireless Remote Controller (Silver)
BYFQ60C2W1S	Low Profile Decoration Panel (Silver) - 1- <sup>13</sup> / <sub>16</sub> × 24- <sup>7</sup> / <sub>16</sub> × 24- <sup>7</sup> / <sub>16</sub>
BYFQ60C2W1W	Low Profile Decoration Panel (White) - 1- <sup>13</sup> / <sub>16</sub> × 24- <sup>7</sup> / <sub>16</sub> × 24- <sup>7</sup> / <sub>16</sub>
BRYQ60A2S	Sensor kit (Silver) intelligent Eye, Comfort Airflow, and Floor Sensor
BRYQ60A2W	Sensor kit (White) intelligent Eye, Comfort Airflow, and Floor Sensor
BDBHQ44C60	Sealing member of air discharge outlet
KAF441C60	Long life filter

### IDEAL SOLUTIONS FOR:

- » Renovations, remodeling and new construction
- » Sun rooms, basements, garages, hot or cold rooms, attics where the walls tend to be lower, or wherever wall space is at a premium
- » Ceiling void or attic does not allow for a viable standard ducted solution
- » Homeowners' reluctance to use a visible wall or a floor mounted unit



**Draft Reduction** – This system directs warm air to the floor in winter and cool air across the room in summer for optimal efficiency and comfort. The large flap governs airflow direction while the small flap (or diffuser) swings, producing fine air currents that help circulate the air around the room.



**Individual Louver Control** – The new louver changes the delivery angle to horizontal for cooling and vertical for heating operation, to keep cold or warm air from blowing directly onto your body.



**Included in the optional sensor kit: Presence and Floor Sensor** (optional part #BRYQ60A2W or BRYQ60A2S) – The presence and floor sensors are infrared sensors with the ability to sense movement in the room. When you are in the room, the system operates normally. If you leave the room for more than 20 minutes the system automatically changes to an energy-saving operation. The floor sensor detects the average floor temperature and ensures even temperature distribution between ceiling and floor.

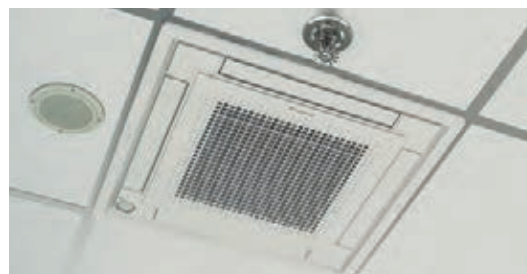

The Daikin *VISTA* Ceiling Cassette fits within a 2' x 2' ceiling grid and can be installed in close proximity to other building accessories.



# Multi-Zone Systems INDOOR UNITS Daikin VISTA Ceiling Cassette FFQ\_W2VJU9

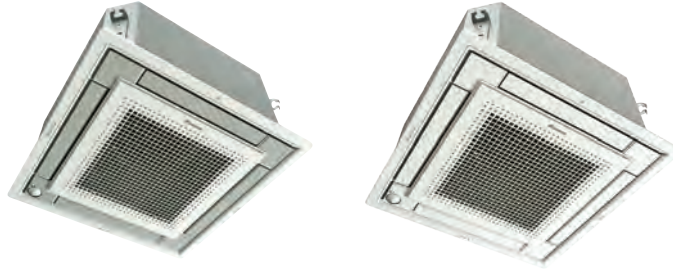

MULTI-ZONE SYSTEMS

Model			FFQ09W2VJU9		FFQ12W2VJU9	
			Cooling	Heating	Cooling	Heating
Nominal Capacity			9 kBtu/h Class		12 kBtu/h Class	
Airflow Rate	H	cfm (m <sup>3</sup> /min)	378 (10.7)	399 (11.3)	406 (11.5)	427 (12.1)
	M		339 (9.6)	357 (10.1)	353 (10.0)	371 (10.5)
	L		268 (7.6)	282 (8.0)	268 (7.6)	282 (8.0)
Fan	Speed	Steps	Turbo fan, 3 steps			
Air Direction Control			+			
Dimensions (H × W × D)		in. (mm)	10-1/4 × 22-5/8 × 22-5/8 (260 × 575 × 575)			
Weight		lbs. (kg)	36 (16)			
Sound Pressure Level	H / M / L	dB(A)	38 / 35 / 29		39 / 36 / 30	
Heat Insulation			Both Liquid and Gas Pipes			
Piping Connections	Liquid	in. (mm)	Ø 1/4 (Ø 6.4)			
	Gas		Ø 3/8 (Ø 9.5)			
	Drain		Ø 1-1/32 (Ø 26)			

Model			FFQ09W2VJU9		FFQ12W2VJU9	
			Cooling	Heating	Cooling	Heating
Nominal Capacity			15 kBtu/h Class		18 kBtu/h Class	
Airflow Rate	H	cfm (m <sup>3</sup> /min)	420 (11.9)	441 (12.5)	448 (12.7)	498 (14.1)
	M		367 (10.4)	385 (10.9)	378 (10.7)	420 (11.9)
	L		293 (8.3)	307 (8.7)	275 (7.8)	30 (8.7)
Fan	Speed	Steps	Turbo fan, 3 steps			
Air Direction Control			+			
Dimensions (H × W × D)		in. (mm)	10-1/4 × 22-5/8 × 22-5/8 (260 × 575 × 575)			
Weight		lbs. (kg)	36 (16)		39 (17.5)	
Sound Pressure Level	H / M / L	dB(A)	40 / 37 / 31		44 / 40 / 32	
Piping Connections	Liquid	in. (mm)	Ø 1/4 (Ø 6.4)			
	Gas		Ø 1/2 (Ø 12.7)			
	Drain		Ø 1-1/32 (Ø 26)			

# Multi-Zone Combinations

Max: 24k BTU/h 2MXL18 / 2MXS18	Max: 39k BTU/h 3MXL24 / 3MXS24		Max: 48k BTU/h 4MXL36/4MXS36				
2 ZONE	2 ZONE	3 ZONE	2 ZONE	3 ZONE		4 ZONE	
07+07	07+07	07+07+07	07+07	07+07+07	09+09+15	07+07+07+07	07+09+09+18
07+09	07+09	07+07+09	07+09	07+07+09	09+09+18	07+07+07+09	07+09+12+12
07+12	07+12	07+07+12	07+12	07+07+12	09+09+24	07+07+07+12	07+09+12+15
07+15	07+15	07+07+15	07+15	07+07+15	09+12+12	07+07+07+15	07+09+12+18
09+09	07+18	07+07+18	07+18	07+07+18	09+12+15	07+07+07+18	07+09+15+15
09+12	09+09	07+09+09	07+24	07+07+24	09+12+18	07+07+07+24	07+12+12+12
09+15	09+12	07+09+12	09+09	07+09+09	09+12+24	07+07+09+09	07+12+12+15
12+12	09+15	07+09+15	09+12	07+09+12	09+15+15	07+07+09+12	09+09+09+09
	09+18	07+09+18	09+15	07+09+15	09+15+18	07+07+09+15	09+09+09+12
	12+12	07+12+12	09+18	07+09+18	09+15+24	07+07+09+18	09+09+09+15
	12+15	07+12+15	09+24	07+09+24	09+18+18	07+07+09+24	09+09+09+18
	12+18	07+12+18	12+12	07+12+12	12+12+12	07+07+12+12	09+09+12+12
	15+15	07+15+15	12+15	07+12+15	12+12+15	07+07+12+15	09+09+12+15
	15+18	09+09+09	12+18	07+12+18	12+12+18	07+07+12+18	09+09+12+18
	18+18	09+09+12	12+24	07+12+24	12+12+24	07+07+15+15	09+09+15+15
		09+09+15	15+15	07+15+15	12+15+15	07+07+15+18	09+12+12+12
		09+09+18	15+18	07+15+18	12+15+18	07+09+09+09	09+12+12+15
		09+12+12	15+24	07+18+18	12+18+18	07+09+09+12	12+12+12+12
		09+12+15	18+18	09+09+09	15+15+15	07+09+09+15	
		09+12+18	18+24	09+09+12	15+15+18		
		09+15+15	24+24*				
		12+12+12					
		12+12+15					

\*24k BTU/h IDU connection only possible with optional 1/2" to 5/8" adaptor (4015872).

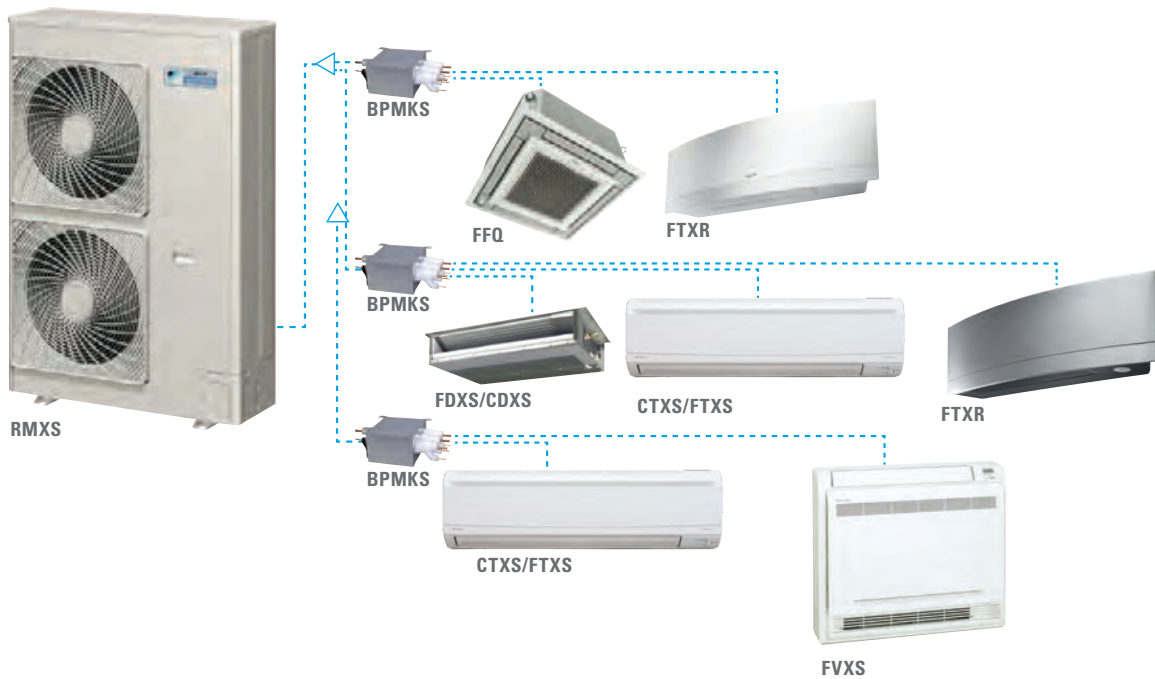

# Multi-Zone Combinations

Max: 58k BTU/h 5MXS48								
2 ZONE	3 ZONE		4 ZONE			5 ZONE		
07+07	07+07+07	09+12+12	07+07+07+07	07+09+12+15	09+09+12+18	07+07+07+07+07	07+07+09+15+15	09+09+09+12+15
07+09	07+07+09	09+12+15	07+07+07+09	07+09+12+18	09+09+12+24	07+07+07+07+09	07+07+09+15+18	09+09+09+12+18
07+12	07+07+12	09+12+18	07+07+07+12	07+09+12+24	09+09+15+15	07+07+07+07+12	07+07+12+12+12	09+09+09+15+15
07+15	07+07+15	09+12+24	07+07+07+15	07+09+15+15	09+09+15+18	07+07+07+07+15	07+07+12+12+15	09+09+12+12+12
07+18	07+07+18	09+15+15	07+07+07+18	07+09+15+18	09+09+15+24	07+07+07+07+18	07+07+12+12+18	09+09+12+12+15
07+24	07+07+24	09+15+18	07+07+07+24	07+09+15+24	09+09+18+18	07+07+07+07+24	07+09+09+09+09	09+12+12+12+12
09+09	07+09+09	09+15+24	07+07+09+09	07+09+18+18	09+12+12+12	07+07+07+09+09	07+09+09+09+12	
09+12	07+09+12	09+18+18	07+07+09+12	07+09+18+24	09+12+12+15	07+07+07+09+12	07+09+09+09+15	
09+15	07+09+15	09+18+24	07+07+09+15	07+12+12+12	09+12+12+18	07+07+07+09+15	07+09+09+09+18	
09+18	07+09+18	09+24+24	07+07+09+18	07+12+12+15	09+12+12+24	07+07+07+09+18	07+09+09+09+24	
09+24	07+09+24	12+12+12	07+07+09+24	07+12+12+18	09+12+15+15	07+07+07+09+24	07+09+09+12+12	
12+12	07+12+12	12+12+15	07+07+12+12	07+12+12+24	09+12+15+18	07+07+07+12+12	07+09+09+12+15	
12+15	07+12+15	12+12+18	07+07+12+15	07+12+15+15	09+12+18+18	07+07+07+12+15	07+09+09+12+18	
12+18	07+12+18	12+12+24	07+07+12+18	07+12+15+18	09+15+15+15	07+07+07+12+18	07+09+09+15+15	
12+24	07+12+24	12+15+15	07+07+12+24	07+12+15+24	09+15+15+18	07+07+07+12+24	07+09+09+15+18	
15+15	07+15+15	12+15+18	07+07+15+15	07+12+18+18	12+12+12+12	07+07+07+15+15	07+09+12+12+12	
15+18	07+15+18	12+15+24	07+07+15+18	07+15+15+15	12+12+12+15	07+07+07+15+18	07+09+12+12+15	
15+24	07+15+24	12+18+18	07+07+15+24	07+15+15+18	12+12+12+18	07+07+07+18+18	07+09+12+12+18	
18+18	07+18+18	12+18+24	07+07+18+18	07+15+18+18	12+12+15+15	07+07+09+09+09	07+09+12+15+15	
18+24	07+18+24	15+15+15	07+07+18+24	09+09+09+09	12+12+15+18	07+07+09+09+12	07+12+12+12+12	
24+24	07+24+24	15+15+18	07+09+09+09	09+09+09+12	12+15+15+15	07+07+09+09+15	07+12+12+12+15	
	09+09+09	15+15+24	07+09+09+12	09+09+09+15		07+07+09+09+18	09+09+09+09+09	
	09+09+12	15+18+18	07+09+09+15	09+09+09+18		07+07+09+09+24	09+09+09+09+12	
	09+09+15	15+18+24	07+09+09+18	09+09+09+24		07+07+09+12+12	09+09+09+09+15	
	09+09+18	18+18+18	07+09+09+24	09+09+12+12		07+07+09+12+15	09+09+09+09+18	
	09+09+24		07+09+12+12	09+09+12+15		07+07+09+12+18	09+09+09+12+12	

MULTI-ZONE SYSTEMS









*SkyAir* Products



# SkyAir Heat Pumps and Air Conditioners



## Quick and easy installation for a broad range of applications

SkyAir is the ultimate ducted and duct free solution for light commercial and residential whole house applications. Ranging from 18,000 Btu/h to 48,000 Btu/h, these innovative systems provide energy efficiency, technological reliability and installation flexibility.

### SkyAir systems key features and benefits include:

- › DC fan motor improves efficiency compared to conventional AC motors.
- › Aero spiral fan and grille minimizes turbulence and increases sound reduction.
- › Reluctance brushless DC compressor increases efficiency compared to fixed-speed compressor technology.
- › Swing Compressor Model – Friction and refrigerant leakage are minimized for greater energy savings.
- › Long piping lengths up to 230 ft. allow layout flexibility.
- › Anti-corrosion treatment on the outdoor heat exchanger increases durability.
- › Low-Ambient cooling operation down to 0°F (with optional Air Adjustment Grille(s))

Model	
<b>Wall-Mounted Units (FAQ Type)</b>	<ul style="list-style-type: none"> <li>» For rooms with no false ceiling nor free floor space</li> <li>» Energy efficiency up to SEER 17.6 and HSPF 8.6</li> <li>» Wide angle louvers distribute comfortable airflow with Auto-swing function</li> <li>» Quiet operation as low as 37 dB(A) (on L fan setting)</li> </ul>
<b>DC Duct Concealed (FBQ Type)</b>	<ul style="list-style-type: none"> <li>» Medium external static pressure (ESP) capabilities offer up to 0.8 "W.G.</li> <li>» DC fan motor provides improved efficiency</li> <li>» Three user selected fan speeds available plus fan "Auto" logic</li> <li>» Built-in condensate pump</li> <li>» Bottom access for easy service</li> <li>» Low profile design at less than 12" high</li> </ul>
<b>Round Flow Sensing Cassette (FCQ Type)</b>	<ul style="list-style-type: none"> <li>» 18 configurable airflow patterns ensure ideal air distribution</li> <li>» 360° airflow and three room sensors enables optimized occupant comfort and efficiency</li> <li>» Lower air velocities provide better airflow distribution</li> <li>» Optional self-cleaning filter panel to automatically clean filters on a set schedule.</li> <li>» Condensate pump provided as standard</li> </ul>
<b>Ceiling Suspended (FHQ Type)</b>	<ul style="list-style-type: none"> <li>» Slim height at less than 8"</li> <li>» Auto-swing capability with 100° airflow pattern distributes comfortable airflow</li> <li>» Innovative stream fan technology keeps sound pressure levels low</li> <li>» Lateral servicing space allows installation in corners, narrow spaces, walls, and ceilings</li> </ul>
<b>Multi-positional Air Handling Unit (FTQ Type)</b>	<ul style="list-style-type: none"> <li>» Up flow, downflow, horizontal left or horizontal right configurations for the indoor unit</li> <li>» Designed for zero clearance on three sides and only 24" clearance on the front for service.</li> <li>» 100% heating capacity at -4°F (-20C) on systems up to 3 tons, without electrical heat</li> <li>» Field-installed electric heater options available from 3kW to 19 kW (electric heater connection kit part no.</li> </ul>

- » *Energy-Intelligent* technology with variable-speed compressors for small offices, shops, retail, stores, restaurants, banks, or technical cooling
- » Provides reliable and high quality comfort with a smart use of energy and flexible installation and operation
- » Can provide total comfort over space heating and cooling needs

## Wide range of simple and/or intelligent controllers to choose from



- Available in Heat Pump
- Available in Cooling Only

Indoor Unit name	Sizes available (rated Cooling kBTU/h)						Matching Outdoor Units
	18	24	30	36	42	48	
 FAQ_TAVJU	 	 					RZR_TBvjua (Cooling Only) RZO_TBvjua (Heat Pump) 
 FBQ_TBvJU	 	 	 	 	 	 	RZR_TBvjua (Cooling Only) RZO_TBvjua (Heat Pump) 
 FCQ_AAVJU	 	 	 	 	 	 	RZR_TBvjua (Cooling Only) RZO_TBvjua (Heat Pump) 
 FHQ_PVJU FHQ_MVJU*	 	 	 	  *	  *		RZR_TAVJU(A) (Cooling Only) RZO_TAVJU(A) (Heat Pump) 
 FTQ_TAVJUD/A	 	 	 	 	 	 	RZR_TBvjua (Cooling Only) RZO_TBvjua (Heat Pump) 

## FAQ\_TAVJU

## RZR\_TBVJUA / RZO\_TBVJUA

# Wall-Mounted Unit

## COMFORTABLE LIMITED WARRANTY\* PROTECTION



\* Complete warranty details available from your local dealer/contractor or at [www.daikincomfort.com](http://www.daikincomfort.com). Warranty registration not required to receive the 10-Year Parts Limited Warranty for residential or commercial installations. The duration of warranty coverages in Texas differs in some cases.

## Sleek in design with comfort control features.

### Standard Features

- » Energy efficiency up to 17.3 SEER2 and up to 7.8 HSPF2
- » Wide angle louvers distribute comfortable airflow
- » Auto-swing function ensures efficient air distribution
- » Front panel can be removed for easy cleaning
- » Quiet operation as low as 37 dB(A)
- » Optional wireless controller
- » Optional wired controller
- » Optional condensate pump



FAQ\_TAVJU



BRC1E73



AZAI6WSCDKA



BRC7E818



BRC1H71W



AZAI6WSPDKC

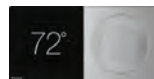

DTST-ONE-ADA-A



RZR\_TBVJUA  
RZO\_TBVJUA



# FAQ\_TAVJU RZR\_TBVJUA / RZQ\_TBVJUA Wall-Mounted Unit

SKYAIR PRODUCTS

Model	Indoor Unit		FAQ18TAVJU		FAQ24TAVJU	
	Outdoor Unit (Cooling Only)		RZR18TBVJUA		RZR24TBVJUA	
	Outdoor Unit (Heat Pump)		RZQ18TBVJUA		RZQ24TBVJUA	
Cooling Capacity*, Outside Temp 95°FDB	Btu/h		18,000		24,000	
Heating Capacity*, Outside Temp 47°FDB			20,000		27,000	
Heating Capacity*, Outside Temp 17°FDB			13,800		20,000	
COP Rated*			3.0		2.7	
EER 2 (rated)			11.9		10.2	
SEER 2 (rated)			16.9		17.3	
HSPF 2 (rated)			7.6		7.8	
Piping Connections	Liquid	in. (mm)	Ø 3/8 (Ø 9.5)			
	Gas		Ø 5/8 (Ø 15.8)			
	Drain		Ø 1/2 (Ø 13)			
Max. Interunit Piping Length			164(50)			
Max. Interunit Height Difference			98.4 (30)			
Chargeless	lbs. (kg)		15 (4.5)			
Amount of Additional Charge of Refrigerant	lbs./ft. (kg/m)		0.036 (0.0536)			
Operating Range – Cooling	°F DB (°C DB)		23° – 122°F (-5 – 50°C)			
Cooling range with Optional Air Adjustment Grille	°F DB (°C DB)		0° - 122°F (-17.7° - 50°C)			
Operating Range – Heating*	°F WB (°C WB)		-4° – 60°F (-20 – 15.5°C)			
Indoor Unit			FAQ18TAVJU		FAQ18TAVJU	
Airflow Rate	H	cfm (m³/min)	500 (14.2)		635 (18)	
	M		400 (11.3)		470 (13.3)	
Fan Type			Cross flow fan			
Air Direction Control			N/A			
Air Filter			Resin net (Washable)			
Dimensions (H x W x D)	in. (mm)		11-3/8 x 41-3/8 x 9-1/4 (290 x 1050 x 238)			
Weight	lbs. (kg)		31 (14)			
Sound Pressure Level (H / L)	dB(A)		43 / 37		47 / 41	
Outdoor Unit			RZQ18TAVJUA / RZR18TAVJUA		RZQ24TAVJUA / RZR24TAVJUA	
Compressor	Motor Output	W	1,900			
Refrigerant	Type		R-410A			
	Charge	lbs. (kg)	6.4 (2.9)			
Airflow Rate	H	cfm (m³/min)	2,682 (76)			
Dimensions (H x W x D)	in. (mm)		39 x 37 x 12-5/8 (990 x 940 x 320)			
Weight	lbs. (kg)		172 (78)			
Sound Pressure Level	H	dB(A)	58	61*	58	61*

\*Capacities are net, including a deduction for cooling (an addition for heating) for indoor fan motor heat.

Outdoor Unit Optional Accessories	
KPW5G112	Air Adjustment Grille (RZR18, 24; RZQ18, 24)
KEHJ5A160E	Drain Pan Heater (RZQ18, 24)
KPS00344	Snow Visor (RZR18, 24; RZQ18, 24)
VRVQA-SH-SF	Snow Hood Kit (RZR18, 24; RZQ18, 24)

# FBQ\_TBVJU RZR\_TBVJUA / RZO\_TBVJUA DC Duct Concealed

COMFORTABLE LIMITED  
WARRANTY\* PROTECTION



\* Complete warranty details available from your local dealer/contractor or at [www.daikincomfort.com](http://www.daikincomfort.com). Warranty registration not required to receive the 10-Year Parts Limited Warranty for residential or commercial installations. The duration of warranty coverages in Texas differs in some cases.

## Sleek in design with comfort control features.

### Premium Comfort Features

- » Medium external static pressure (ESP) capabilities offer up to 0.8 "W.G.
- » DC fan motor provides excellent efficiency
- » Three user selected fan speeds available plus fan "Auto" logic
- » Built-in condensate pump and drain pan inspection port
- » Bottom access for easy service
- » Low profile design at less than 10" high
- » Optional wired controller
- » Connect to Daikin Zoning Kit (Optional)

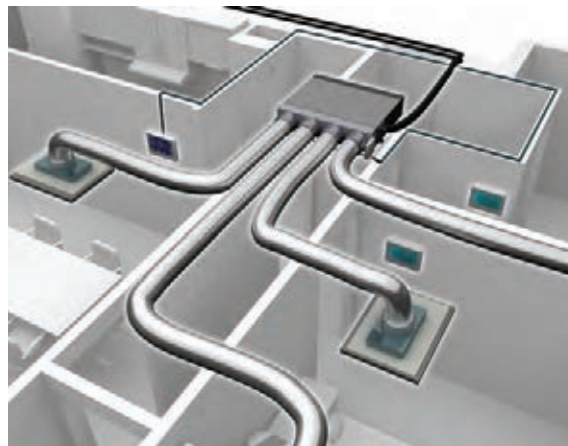

- » Increases the flexibility of the SkyAir systems in both residential and commercial applications by adding a Zoning Box to an indoor unit fan coil
- » Allows several separate ducts to supply air to different individually-controlled zones.
- » The DZK BACnet™ Interface will work with any BACnet/IP compatible Building Management System



Wired\*  
Thermostat



Wireless\*  
Thermostat



Wireless Lite\*  
Thermostat  
\*for DZK Kit



RZR\_TBVJUA  
RZO\_TBVJUA



FBQ\_TBVJU



DZK Kit  
(Option)



AZAI6WSCDKA



DTST-ONE-ADA-A



BRC1H71W



BRC1E73



BRC4C82  
BRC082A43



AZAI6WSPDKC

# FBQ\_TBVJU RZR\_TBVJUA / RZQ\_TBVJUA DC Duct Concealed

SKYAIR PRODUCTS

Model			Indoor Unit		FBQ18TBVJU	FBQ24TBVJU	FBQ30TBVJU	FBQ36TBVJU	FBQ42TBVJU	FBQ48TBVJU						
			Outdoor Unit (Cooling Only)		RZR18TBVJUA	RZR24TBVJUA	RZR30TBVJUA	RZR36TBVJUA	RZR42TBVJUA	RZR48TBVJUA						
			Outdoor Unit (Heat Pump)		RZQ18TBVJUA	RZQ24TBVJUA	RZQ30TBVJUA	RZQ36TBVJUA	RZQ42TBVJUA	RZQ48TBVJUA						
Cooling Capacity*, Outside Temp 95°FDB			Btu/h		17,700	23,400	28400	35000	40000	46500						
Heating Capacity*, Outside Temp 47°FDB					20,600	27,400	34800	40000	47000	54000						
Heating Capacity*, Outside Temp 17°FDB					14,000	19,000	24000	28000	32400	38000						
COP Rated					2.9	3.1	3.4	3.3	3.7	3.1						
EER2 (rated)					12.5	10.5	12.2	11.7	19.3	8.3						
SEER2 (rated)					15.5	15.4	16.5	16.9	15.6	15.3						
HSPF2 (rated)					8.5	9.3	8.9	8.8	9.5	9.3						
Piping Connections	Liquid	in. (mm)	Ø 3/8 (Ø 9.5)													
	Gas		Ø 5/8 (Ø 15.8)													
	Drain		Ø 1 (Ø 25.4)													
Max. Interunit Piping Length					164 (50)			230 (70)								
Max. Interunit Height Difference			ft. (m)		98.4 (30)											
Chargeless					15 (4.5)											
Amount of Additional Charge of Refrigerant			lb./ft. (kg/m)		0.036 (0.0535)											
Operating Range - Cooling			°F DB (°C DB)		23° - 122°F (-5 - 50°C)											
Cooling range with Optional Air Adjustment Grille			°F DB (°C DB)		0° - 122°F (-17.7° - 50°C)											
Operating Range - Heating*			°F WB (°C WB)		-4° - 60°F (-20 - 15.5°C)											
Indoor Unit			FBQ18TBVJU	FBQ24PBVJU	FBQ30TBVJU	FBQ36TBVJU	FBQ42TBVJU	FBQ48TBVJU								
External Static Pressure			In. Wg (Pa)	Standard 0.40 <0.80-0.20> (100 <200-50>)**												
Airflow Rate	H	cfm (m³/min)	635 (18)	742 (21)	1094 (31)	1130 (32)	1377 (39)	1377 (39)								
	M		565 (16)	635 (18)	847 (24)	953 (27)	1130 (32)	1130 (32)								
	L		512 (14.5)	565 (16)	795 (22.5)	795 (22.5)	918 (26)	918 (26)								
Fan			Type		Sirocco Fan											
Air Direction Control					N/A											
Air Filter					N/A											
Dimensions (H x W x D)			in. (mm)		9-11/16 x 39-3/8 x 31-1/2 (245 x 1,000 x 800)			9-13/16 x 55-1/8 x 31-1/2 (245 x 1400 x 800)								
Weight			lbs. (kg)		77 (35)	82 (37)	101 (46)		104 (47)							
Sound Pressure Level (HH / H / L)			dB(A)		38/35/32	39/35/22	43/38/36	44/40/36	48/44/39							
Outdoor Unit			RZR18TBVJU / RZQ18TBVJUA	RZR24TBVJUA / RZQ24TBVJUA	RZR30TBVJUA / RZQ30TBVJUA	RZR36TBVJUA / RZQ36TBVJUA	RZR42TBVJUA / RZQ42TBVJUA	RZR48TBVJUA / RZQ48TBVJUA								
Compressor			Motor Output		W		1,900		3,500							
Refrigerant			Type		R-410A											
			Charge		lbs. (kg)		6.4 (2.9)		7.9 (3.6)							
Airflow Rate			H		cfm (m³/min)		2682 (76)		3,741 (106)							
Dimensions (H x W x D)			in. (mm)		39 x 37 x 12-5/8 (990 x 940 x 320)			52-15/16 x 35-7/16 x 12-5/8 (1345 x 900 x 320)								
Weight			lbs. (kg)		172 (78)			225 (102)								
Sound Pressure Level			H		dB(A)		58	61*	58	61*	57	59*	57	59*	57	59*

\* Capacities are net, including a deduction for cooling (an addition for heating) for indoor fan motor heat.

### Outdoor Unit Optional Accessories

KPW5G112	Air Adjustment Grille (RZR18, 24; RZQ18, 24)
KPW5F80 x 2	Air Adjustment Grille (RZR30, 36, 42, 48; RZQ30, 36, 42, 48)
KEHJ5A160E	Drain Pan Heater (RZQ18, 24, 30, 36, 42, 48)
KPS00344	Snow Visor (RZR18, 24, 30, 36, 42, 48; RZQ18, 24, 30, 36, 42, 48)
VRVQA-SH-SF	Snow Hood Kit (RZR18, 24; RZQ18, 24)
VRVQA-SH-DF	Snow Hood Kit (RZR30, 36, 42, 48; RZQ30, 36, 42, 48)

**MERV 13 Filter Kit Option contains a MERV 13 filter, adaptor frame and easy to follow installation instructions and can be installed on the following models only:**

Kit Model	Indoor Unit
DFBS39A13	FBQ18-24TBVJU
DFBS55A13	FBQ30-48TBVJU

# FCQ\_AAVJU RZR\_TBVJUA / RZQ\_TBVJUA Round Flow Sensing Cassette

COMFORTABLE LIMITED  
WARRANTY\* PROTECTION



\* Complete warranty details available from your local dealer/contractor or at [www.daikincomfort.com](http://www.daikincomfort.com). Warranty registration not required to receive the 10-Year Parts Limited Warranty for residential or commercial installations. The duration of warranty coverages in Texas differs in some cases.

## Customizable comfort ideal for open plan applications.

### Premium Comfort Features

- » 18 configurable airflow patterns ensure ideal air distribution for maximized comfort and savings
- » 360° airflow and three room sensors enables optimized occupant comfort and efficiency
- » Lower air velocities provide better airflow distribution
- » Optional self-cleaning filter panel to automatically clean filters on a set schedule.
- » Condensate pump provided as standard
- » Outside air integration possible

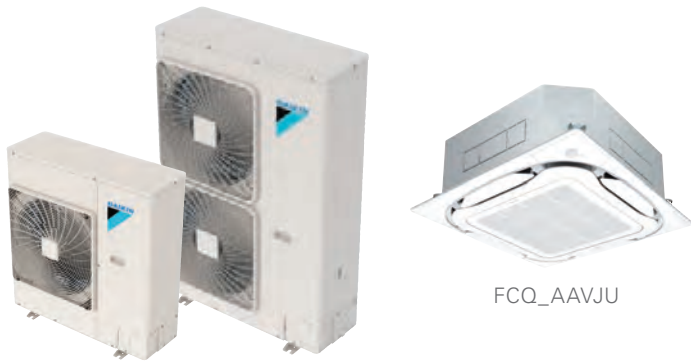

FCQ\_AAVJU



AZAI6WSCDKA

BRC1E73

DTST-ONE-ADA-A



BRC1H71W

AZAI6WSPDKC



Self-Cleaning Air Filter Panel



# FCQ\_AAVJU RZR\_TBvjua / RZQ\_TBvjua Round Flow Sensing Cassette

SKYAIR PRODUCTS

Model	Indoor Unit		FCQ18AAVJU	FCQ24AAVJU	FCQ30AAVJU	FCQ36AAVJU	FCQ42AAVJU	FCQ48AAVJU						
	Outdoor Unit (Cooling Only)		RZR18TBVJUA	RZR24TBVJUA	RZR30TBVJUA	RZR36TBVJUA	RZR42TBVJUA	RZR48TBVJUA						
	Outdoor Unit (Heat Pump)		RZQ18TBVJUA	RZQ24TBVJUA	RZQ30TBVJUA	RZQ36TBVJUA	RZQ42TBVJUA	RZQ48TBVJUA						
Cooling Capacity*, Outside Temp 95°FDB	Btu/h		18,000	24,000	30,000	36,000	42,000	48,000						
Heating Capacity*, Outside Temp 47°FDB			20,000	27,000	34,000	40,000	47,000	54,000						
Heating Capacity*, Outside Temp 17°FDB			12,300	18,000	22,800	26,200	31,200	34,800						
COP Rated			4.3	3.8	4.5	4.3	4.0	3.5						
EER2 (rated)			13	12	13	12.1	10.3	8.2						
SEER2 (rated)			18.5	18.6	21	20	18.9	18						
HSPF2 (rated)			9.2	9.1	10.1	10	10.2	10.3						
Piping Connections	Liquid	in. (mm)	Ø 3/8 (Ø 9.5)											
	Gas		Ø 5/8 (Ø 15.8)											
	Drain		Ø 1 (Ø 25.4)											
Max. Interunit Piping Length	ft. (m)		164 (50)			230 (70)								
Max. Interunit Height Difference			98.4 (30)											
Chargeless	lbs. (kg)		15 (4.5)											
Amount of Additional Charge of Refrigerant	lb/ft. (kg/m)		0.036 (0.0535)											
Operating Range - Cooling	°F DB (°C DB)		23° - 122°F (-5 - 50° C)											
Cooling range with Optional Air Adjustment Grille	°F DB (°C DB)		0° - 122°F (-17.7° - 50° C)											
Operating Range - Heating*	°F WB (°C WB)		-4° - 60°F (-20 - 15.5° C)											
Indoor Unit			FCQ18AAVJU	FCQ24AAVJU	FCQ30AAVJU	FCQ36AAVJU	FCQ42AAVJU	FCQ48AAVJU						
Airflow Rate	H	cfm (m³/min)	742 (21.0)	777 (22.0)	1059 (30)	1165 (33.0)	1218 (34.5)	1218 (34.5)						
	M		618 (17.5)	618 (17.5)	918 (26.0)	918 (26.0)	971 (27.5)	971 (27.5)						
	L		477 (13.5)	477 (13.5)	882 (25.0)	671 (19.0)	742 (21.0)	742 (21.0)						
Fan Type			Turbo Fan											
Air Direction Control			N/A											
Air Filter			N/A											
Dimensions (H x W x D)	in. (mm)		9-11/16 x 33-1/16 x 33-1/16 (246 x 840 x 840)			11-11/32 x 33-1/16 x 33-1/16 (288 x 840 x 840)								
Weight	lbs. (kg)		51 (28.5)			58(26)								
Sound Pressure Level (H / M / L)	dB(A)		38/32/28		42/37/32	47 / 38 / 32	47 / 40 / 35							
Outdoor Unit			RZR18TBVJUA / RZQ18TBVJUA	RZR24TBVJUA / RZQ24TBVJUA	RZR30TBVJUA / RZQ30TBVJUA	RZR36TBVJUA / RZQ36TBVJUA	RZR42TBVJUA / RZQ42TBVJUA	RZR48TBVJUA / RZQ48TBVJUA						
Compressor	Motor Output	W	1,900			3,500								
Refrigerant	Type		R-410A											
	Charge	Lbs (kg)	6.4 (2.9)			7.9 (3.6)								
Airflow Rate	H	cfm (m³/min)	2682 (76)			3,741 (106)								
Dimensions (H x W x D)	in. (mm)		39 x 37 x 12-5/8 (990 x 940 x 320)			52-15/16 x 35-7/16 x 12-5/8 (1345 x 900 x 320)								
Weight	lbs. (kg)		172 (78)			225 (102)								
Sound Pressure Level	H	dB(A)	58	61*	58	61*	57	59*	57	59*	57	59*	57	59*

\* Capacities are net, including a deduction for cooling (an addition for heating) for indoor fan motor heat.

Option	FCQ18-48AAVJU
Self-Cleaning Filter Panel	BYCQ54EEGFU
Standard Sensing Decoration Panel	BYCQ54EEFU

Outdoor Unit Optional Accessories	
KPW5G112	Air Adjustment Grille (RZR18, 24; RZQ18, 24)
KPW5F80 x 2	Air Adjustment Grille (RZR30, 36, 42, 48; RZQ30, 36, 42, 48)
KEHJ5A160E	Drain Pan Heater (RZQ18, 24, 30, 36, 42, 48)
KPS00344	Snow Visor (RZR18, 24, 30, 36, 42, 48; RZQ18, 24, 30, 36, 42, 48)
VRVQA-SH-SF	Snow Hood Kit (RZR18, 24; RZQ18, 24)
VRVQA-SH-DF	Snow Hood Kit (RZR30, 36, 42, 48; RZQ30, 36, 42, 48)

# FHQ\_PVJU / FHQ\_MVJU RZR\_TAVJUA / RZO\_TAVJUA Ceiling Suspended

COMFORTABLE LIMITED  
WARRANTY\* PROTECTION



\* Complete warranty details available from your local dealer/contractor or at [www.daikincomfort.com](http://www.daikincomfort.com). Warranty registration not required to receive the 10-Year Parts Limited Warranty for residential or commercial installations. The duration of warranty coverages in Texas differs in some cases.

## A slim solution for open or structured ceilings.

### Premium Comfort Features

- » Slim in height at less than 8"
- » Auto-swing capability with 100° airflow pattern distributes comfortable airflow
- » Innovative stream fan technology keeps sound pressure levels low
- » Lateral servicing space allows installation in corners, narrow spaces, walls, and ceilings
- » Flat panel design makes cleaning simple
- » Concealed piping
- » Optional wired controller
- » Optional condensate pump



FHQ\_PVJU  
FHQ\_MVJU

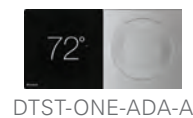
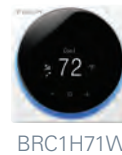

# FHQ\_PVJU / FHQ\_MVJU RZR\_TAVJUA / RZQ\_TAVJUA Ceiling Suspended

SKYAIR PRODUCTS

Model	Indoor Unit		FHQ18PVJU		FHQ24PVJU		FHQ30PVJU		FHQ36MVJU		FHQ42MVJU			
	Outdoor Unit (Cooling Only)		RZR18TAVJUA		RZR24TAVJUA		RZR30TAVJUA		RZR36TAVJUA		RZR42TAVJUA			
	Outdoor Unit (Heat Pump)		RZQ18TAVJUA		RZQ24TAVJUA		RZQ30TAVJUA		RZQ36TAVJUA		RZQ42TAVJUA			
			Cooling	Heating*	Cooling	Heating*	Cooling	Heating*	Cooling	Heating*	Cooling	Heating*		
Capacity Rated		Btu/h	18,000	20,000	24,000	27,000	30,000	34,000	36,000	40,000	40,500	40,000		
COP Rated*			3.9		3.5		3.1		2.8		2.8			
EER Rated			12.9		11.3		10.5		9.5		8.8			
SEER			16.3		16.6		16		14		14			
HSPF*			9.1		9.3		8.4		8.2		8.2			
Piping Connections	Liquid	in. (mm)	Ø 3/8 (Ø 9.5)											
	Gas		Ø 5/8 (Ø 15.8)											
	Drain		Ø 3/4 (Ø 19.1)											
Max. Interunit Piping Length		ft. (m)	164 (50)						230 (70)					
Max. Interunit Height Difference			98.4 (30)											
Chargeless			15 (4.5)											
Amount of Additional Charge of Refrigerant		lb./ft. (kg/m)	0.036 (0.0535)											
Operating Range - Cooling		°F DB (°C DB)	23° - 115°F (-5 - 50°C)											
Cooling range with Optional Air Adjustment Grille		°F DB (°C DB)	0° - 122°F (-17.7° - 50°C)											
Operating Range - Heating*		°F WB (°C WB)	-4° - 60°F (-20 - 15.5°C)											
Indoor Unit			FHQ18PVJU		FHQ24PVJU		FHQ30PVJU		FHQ36MVJU		FHQ42MVJU			
Airflow Rate	H	cfm (m³/min)	790 (22.4)		790 (22.4)		790 (22.4)		830 (23.5)		850 (24.1)			
	M		N/A		N/A		N/A		N/A		N/A			
	L		670 (19)		670 (19)		670 (19)		670 (19)		700 (19.8)			
Fan		Type	Sirocco Fan											
Air Direction Control			N/A											
Air Filter			N/A											
Dimensions (H x W x D)		in. (mm)	7-11/16 x 62-5/8 x 26-3/4 (195 x 1590 x 679)											
Weight		lbs. (kg)	90 (41)											
Sound Pressure Level (H / L)		dB(A)	45 / 41						46 / 41		47 / 42			
Outdoor Unit			RZR18TAV JUA / RZQ18TAVJUA		RZR24TAV JUA / RZQ24TAVJUA		RZR30TAV JUA / RZQ30TAVJUA		RZR36TAV JUA / RZQ36TAVJUA		RZR42TAV JUA / RZQ42TAVJUA			
Compressor		Motor Output	1,900				3,500							
Refrigerant		Type	R-410A											
		Charge	6.4 (2.9)				7.9 (3.6)							
Airflow Rate		H	2682 (76)				3,741 (106)							
Dimensions (H x W x D)		in. (mm)	39 x 37 x 12-5/8 (990 x 940 x 320)						52-15/16 x 35-7/16 x 12-5/8 (1345 x 900 x 320)					
Weight		lbs. (kg)	172 (78)						225 (102)					
Sound Pressure Level		H	58	61*	58	61*	57	59*	57	59*	57	59*		

\* Applicable to heat pump models only, refer to installation manual for more details.

Outdoor Unit Optional Accessories	
KPW5G112	Air Adjustment Grille (RZR18, 24; RZQ18, 24)
KPW5F80 x 2	Air Adjustment Grille (RZR30, 36, 42; RZQ30, 36, 42)
KEHJ5A160E	Drain Pan Heater (RZQ18, 24, 30, 36, 42)
KPS00344	Snow Visor (RZR18, 24, 30, 36, 42; RZQ18, 24, 30, 36, 42)
VRVQA-SH-SF	Snow Hood Kit (RZR18, 24; RZQ18, 24)
VRVQA-SH-DF	Snow Hood Kit (RZR30, 36, 42; RZQ30, 36, 42)

# FTQ\_TAVJUD/A RZR\_TBVJUA / RZQ\_TBVJUA Multi-Position Air Handling Unit

COMFORTABLE LIMITED  
WARRANTY\* PROTECTION



\* Complete warranty details available from your local dealer/contractor or at [www.daikincomfort.com](http://www.daikincomfort.com). Warranty registration not required to receive the 10-Year Parts Limited Warranty for residential or commercial installations. The duration of warranty coverages in Texas differs in some cases.

## An intelligent alternative to traditional unitary systems.

### Standard Features

- » Upflow downflow, horizontal left or horizontal right configurations for the indoor unit
- » Designed for zero clearance on three sides and only 24" clearance on the front for service.
- » 100% heating capacity at -4°F on systems up to 3 tons, without electrical heat
- » Field-installed electric heater options available from 3 kW to 19 kW
- » Factory installed disconnect switch



RZR\_TBVJUA  
RZQ\_TBVJUA



FTQ\_TAVJU



AZAI6WSCDKA



BRC1H71W

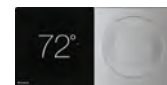

DTST-ONE-ADA-A



BRC1E73



BRC4C82



AZAI6WSPDKC



# FTQ\_TAVJUD/A RZR\_TBVJUA / RZQ\_TBVJUA Multi-Position Air Handling Unit

SKYAIR PRODUCTS

Model	Indoor Unit		FTQ18TAVJUD	FTQ24TAVJUD	FTQ30TAVJUD	FTQ36TAVJUD	FTQ42TAVJUD	FTQ48TAVJUD	
	Indoor Unit (Without Factory Disconnect)		FTQ18TAVJUA	FTQ24TAVJUA	FTQ30TAVJUA	FTQ36TAVJUA	FTQ42TAVJUA	FTQ48TAVJUA	
	Outdoor Unit (Cooling Only)		RZR18TBVJUA	RZR24TBVJUA	RZR30TBVJUA	RZR36TBVJUA	RZR42TBVJUA	RZR48TBVJUA	
	Outdoor Unit (Heat Pump)		RZQ18TBVJUA	RZQ24TBVJUA	RZQ30TBVJUA	RZQ36TBVJUA	RZQ42TBVJUA	RZQ48TBVJUA	
Cooling Capacity*, Outside Temp 95°FDB		Btu/h	17,200	23,400	29,500	35,000	40,500	47,000	
Heating Capacity*, Outside Temp 47°FDB			20,000	27,000	34,000	40,000	47,000	54,000	
Heating Capacity*, Outside Temp 17°FDB			13,600	19,400	24,000	28,500	33,000	36,800	
COP (rated)			3.0	3.3	3.5	3.3	3.5	3.3	
EER2 (rated)			11.7	9.9	11.9	11.2	10.6	9.1	
SEER2 (rated)			15.6	16.2	15.6	16.4	16	15.3	
HSPF2 (rated)			8.1	8.7	9.1	8.8	9.2	8.8	
Piping Connections	Liquid	in. (mm)	Ø 3/8 (Ø 9.5)						
	Gas		Ø 5/8 (Ø 15.8)						
	Drain		Ø 3/4 (Ø 19.1)						
Max. Interunit Piping Length		ft. (m)	164 (50)			230 (70)			
Max. Interunit Height Difference			98.4 (30)						
Chargeless			15 (4.5)						
FTQ Additional Charge†		lbs.	0.1			0.71		1.05	
Amount of Additional Charge of Refrigerant		lb/ft (kg/m)	0.036 (0.0536)						
Operating Range - Cooling		°F DB (°C DB)	23° - 122°F (-5 - 50° C)						
Cooling range with Optional Air Adjustment Grille		°F DB (°C DB)	0° - 122°F (-17.7° - 50°C)						
Operating Range - Heating*		°F WB (°C WB)	-4° - 60°F (-20 - 15.5° C)						
Indoor Unit			FTQ18TAVJUD / FTQ18TAVJUA	FTQ24TAVJUD / FTQ24TAVJUA	FTQ30TAVJUD / FTQ30TAVJUA	FTQ36TAVJUD / FTQ36TAVJUA	FTQ42TAVJUD / FTQ42TAVJUA	FTQ48TAVJUD / FTQ48TAVJUA	
External Static Pressure		In. wg	0.1" - 0.9"						
Airflow Rate	H	cfm (m³/min)	600 (17.0)	800 (22.7)	1000 (28.3)	1050 (29.7)	1400 (39.6)	1520 (43.1)	
	M		510 (14.4)	680 (19.3)	850 (24.1)	900 (25.5)	1190 (32.7)	1290 (36.5)	
	L		420 (11.9)	560 (15.9)	700 (19.8)	750 (21.2)	980 (27.8)	1060 (30)	
Fan Type			Sirocco FC Centrifugal						
Air Direction Control			N/A						
Air Filter			N/A						
Dimensions (H x W x D)		in. (mm)	45 x 17.5 x 21 (1143 x 445 x 533)				53.4 x 21 x 21 (1357 x 533 x 533)		
Weight		lbs. (kg)	115 (52.2)			140 (63.5)	150 (68)		
Sound Pressure Level (H / M / L)		dB(A)	53 / 50 / 47	45 / 41 / 38	52 / 48 / 44	52 / 48 / 44	54 / 50 / 46	54 / 50 / 46	
Outdoor Unit			RZR18TBVJUA / RZQ18TBVJU	RZR24TBVJUA / RZQ24TBVJUA	RZR30TBVJUA / RZQ30TBVJUA	RZR36TBVJUA / RZQ36TBVJUA	RZR42TBVJUA / RZQ42TBVJUA	RZR48TBVJUA / RZQ48TBVJUA	
Compressor Motor Output		W	1,900			3,500			
Refrigerant Type			R-410A						
Refrigerant Charge		lbs. (kg)	6.4 (2.9)			7.9 (3.6)			
Airflow Rate		H cfm (m³/min)	2,682 (76)			3,741 (106)			
Dimensions (H x W x D)		in. (mm)	39 x 37 x 12-5/8 (990 x 940 x 320)			52-15/16 x 35-7/16 x 12-5/8 (1345 x 900 x 320)			
Weight		lbs. (kg)	172 (78)			225 (102)			
Sound Pressure Level		H dB(A)	58	61*	58	61*	57	59*	
						57	59*	57	
						57	59*	57	
						57	59*	57	

\* Capacities are net, including a deduction for cooling (an addition for heating) for indoor fan motor heat.

Electric Heater Options							
Model Name	3kW	5kW	6kW	8kW	10kW	15kW*	19kW*
FTQ18TAVJUD(A)	●	●	●	●	●		
FTQ24TAVJUD(A)	●	●	●	●	●		
FTQ30TAVJUD(A)	●	●	●	●	●		
FTQ36TAVJUD(A)	●	●	●	●	●		
FTQ42TAVJUD(A)		●	●	●	●	●	●
FTQ48TAVJUD(A)		●	●	●	●	●	●

Outdoor Unit Optional Accessories	
KPW5G112	Air Adjustment Grille (RZR18, 24; RZQ18, 24)
KPW5F80 x 2	Air Adjustment Grille (RZR30, 36, 42, 48; RZQ30, 36, 42, 48)
KEHJ5A160E	Drain Pan Heater (RZR18, 24, 30, 36, 42, 48)
KPS00344	Snow Visor (RZR18, 24, 30, 36, 42, 48; RZQ18, 24, 30, 36, 42, 48)
VRVQA-SH-SF	Snow Hood Kit (RZR18, 24; RZQ18, 24)
VRVQA-SH-DF	Snow Hood Kit (RZR30, 36, 42, 48; RZQ30, 36, 42, 48)

\* Two-stage heater control

All combinations of indoor unit capacity & heater capacity may be configured as either Auxiliary Heat or Heat Pump Lockout Heat. Refer to the installation manual for more details.



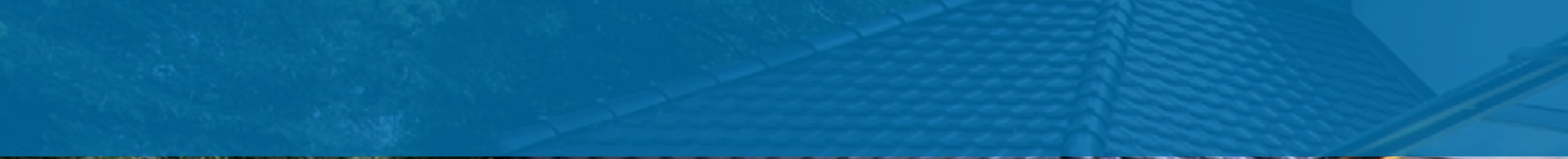





*VRV LIFE*







## Daikin VRV LIFE

Re-inventing residential air-conditioning by breaking technological barriers, Daikin VRV LIFE systems bring inverter driven VRV technology to solve some of the age-old residential HVAC challenges. Precision engineered for flexibility, zoning, low sound and space saving, with the ability to mix and match ducted and duct-free indoor units in combination with a gas furnace. VRV LIFE systems are an ideal choice for a premium solution.

## Solving HVAC Challenges

### Zoning

Modern homes demand zoning for improved comfort and control. Existing air duct zoning kits can quickly add cost, space and complexity of installation. It also does not always provide the desired comfort levels. Many homes are left with areas which are too warm in summer or too cold in winter.

### Operational Efficiencies

Traditional single speed solutions offer basic ON/OFF operation mode only. With the compressor turning ON/OFF constantly, the increased current inrush leads to higher running costs. With little-to-no zoning, operating the entire system when unnecessary reduces savings opportunities.



### Sound

The ON/OFF cycles of a traditional single speed system are often accompanied by undesirable operational sounds. These continuous sounds can become a nuisance in yards especially at night or when it is close to a window. Installing traditional units in sound sensitive applications or close to lot lines leaves homeowners with limited options.

### Flexibility

Traditional single-speed ON/OFF systems provide little to no flexibility for adding zones at a later date as the usage of the home changes or expands. The common practice of adding systems to address the HVAC needs of the new zone quickly add cost and reduce yard space.

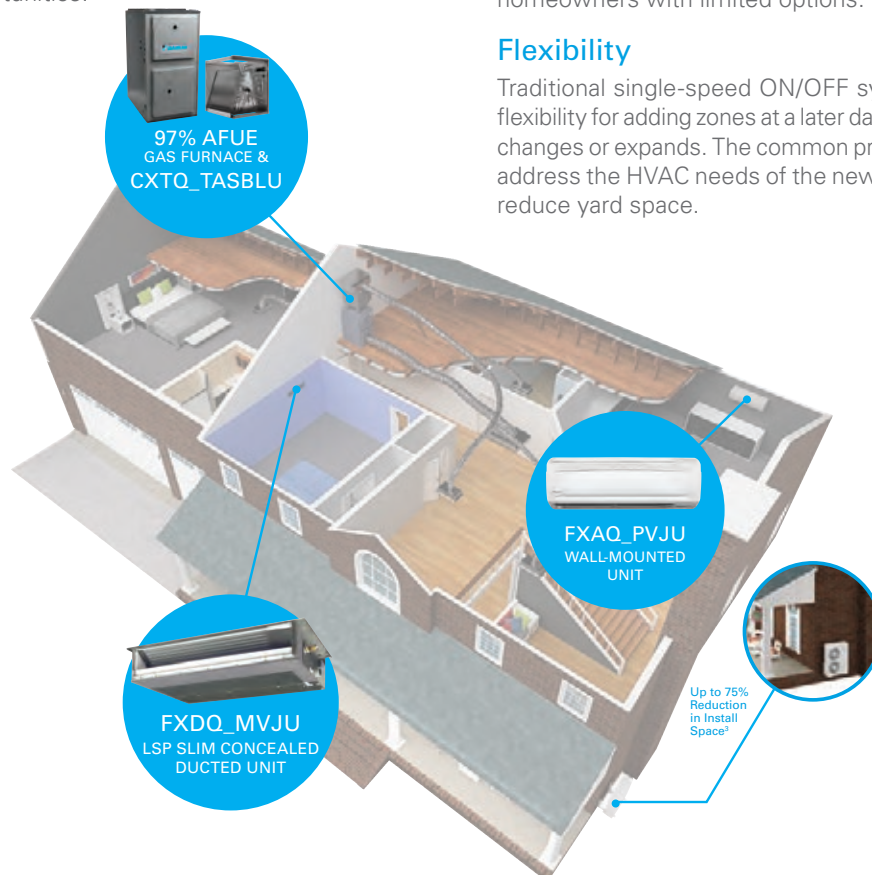



## The Daikin Solution

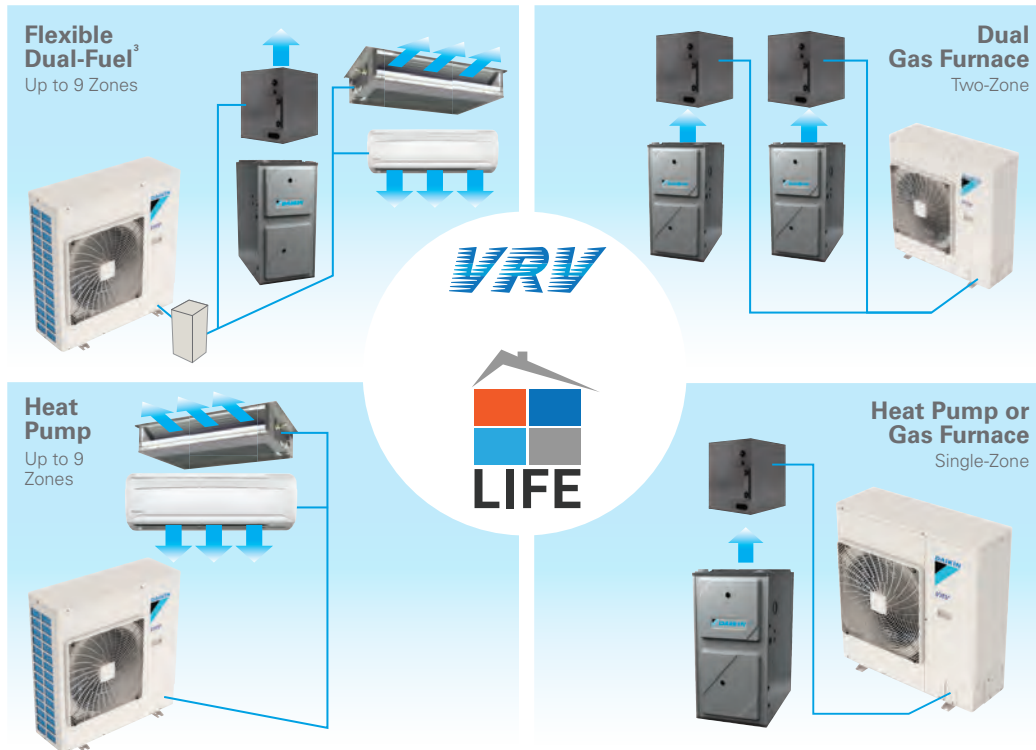

Daikin *VRV LIFE* systems are the industry's first *VRV* Heat Pump with gas furnace connectivity for residential applications. The new *VRV LIFE* systems offers solutions to some of the traditional HVAC challenges for single family applications.

### Zoning

Daikin *VRV LIFE* systems provides effective zoning solutions by offering the flexibility to connect up to 9<sup>1</sup> refrigerant zones to a single system. Precision engineered refrigerant control allows system operation to meet the needs of individual zones.

### Operational Efficiencies

*VRV LIFE* systems are engineered with Daikin inverter and variable refrigerant temperature (VRT) technologies. These empower the compressor to operate at its optimal efficiencies during part load operations and thereby reducing power consumption\* and providing high operational efficiencies.

### Sound

Daikin *VRV* systems are globally renowned for their quietness. With operating sound pressure levels as low as 57 dbA<sup>1</sup>, *VRV LIFE* is an optimal solution for installation close to lot lines and sound sensitive applications.

### Space

With a compact, light weight and space saving design of only 37" W x 12-5/8" D, *VRV LIFE* systems provides up to 75%<sup>2</sup> reduction in installation space compared to similar capacity top discharge unitary condensing units.

<sup>1</sup> Model specific, refer to product engineering manual for details.

<sup>2</sup> When compared to a system of two outdoor units combined with two gas furnaces and A-Coils. <sup>3</sup> Dual-Fuel is achievable only when *VRV* indoor units and gas furnace and A-Coil are connected to one *VRV LIFE* unit. \* Compared to non-inverter units



\* Complete warranty details available from your local dealer/contractor or at [www.daikincomfort.com](http://www.daikincomfort.com). To receive the 12-Year Parts Limited Warranties, or the 12-Year Compressor Replacement Limited Warranty, online registration must be completed within 60 days of installation. Online registration and some of the additional requirements are not required in California or Québec. The duration of warranty coverages in Texas differs in some cases.

## RXSQ - VRV LIFE Outdoor Unit

- » Available in 2, 3, 4 and 5-Ton models
- » Excellent zoning flexibility with 1-to-1 and 1-to-multi connections
- » Broader diversity with ability to provide cooling and heating in up to 9 zones<sup>1</sup>
- » Ability to choose heat pump or multi-zone Dual-Fuel<sup>2</sup> heating capability
- » Auto and programmable modes for heat pump to gas heat switch over temperatures
- » Compatible with 12 types and 65 models of Daikin VRV indoor fan coil units and 80 – 97% AFUE Daikin up flow and down flow communicating gas furnaces
- » Dependable heat pump operation in extreme ambient conditions down to -4°F in heating mode and up to 122°F in cooling mode
- » Year round comfort and energy savings delivered by combining VRV and VRT technologies compared to traditional split systems
- » Operation with sound levels of under 58 dbA<sup>1</sup> make for easy install close to lot lines



- » Compatible with the Daikin *One+* and Daikin *One* touch smart thermostats
- » Reduced installation cost with re-use of existing refrigerant lines and uninsulated liquid line<sup>3</sup>
- » Engineered with Daikin’s swing Inverter compressor technology
- » Backed by 12-Year Parts Limited Warranty and 12-Year Replacement Compressor Limited Warranty\*

VRV LIFE – OUTDOOR – RXSQ						
Model Name		RXSQ24TAVJUA	RXSQ36TAVJUA	RXSQ48TAVJUA	RXSQ60TAVJUA	
ODU Style	Fan Type	Single Fan	Single Fan	Single Fan	Double Fan	
Performance	Nominal Cooling Capacity	BTU/h	24,000	36,000	48,000	57,500
	Nominal Heating Capacity	BTU/h	27,000	40,000	52,000	57,500
	Operation Range Cooling	°F DB	23 to 122			
	Operation Range Heating	°F WB	-4 to 60			
	Power	V/p/Hz	208-230/1/60			
	Sound Pressure Level @ 3ft.	dB(A)	58			
Refrigerant Piping	Refrigerant	R-410A				
	Refrigerant Quantity	lbs.	6.4		7.5	7.9
	Liquid Pipe (Main Line)	in.	3/8			
	Suction Gas Pipe (Main Line)	in.	5/8			3/4
	Vertical Pipe Length	ft.	98			
	Maximum vertical pipe length between IDU	ft.	33		49	
	Actual Pipe Length (Equivalent Length)	ft.	100 (125)			492
	Total Piping Length	ft.	328		492	
Connection Ratio	Connectible Indoor Unit Ratio	% 50-130				
	Number of Indoor Units	Qty	4	6	8	9
Unit	Outdoor Unit Size	(HxWxD)	39 x 37 x 12-5/8		39 x 37 x 12-5/8	52-15/16 x 35-7/16 x 12-5/8
	Weight	lbs.	172		176	225
Fan	Airflow	CFM	2682		2682	3741
	Fan Motor Output and Quantity	kW	0.20 x 1		0.20 x 1	0.070 X 2
Electrical	Maximum Over Current Protection (MOP)	A	25		35	35
	Minimum Circuit Amps (MCA)	A	16.5		29.1	29.1
	Rated Load Amps (RLA)	A	15.3		19.0	23.2
Compressor	Compressor Type	Type	Daikin Swing			
	Capacity Control	%	14-100			

<sup>1</sup> Model specific, refer to product engineering manual for details.

<sup>2</sup> Dual-Fuel is achievable only when VRV indoor units and gas furnace and A-Coil are connected to one VRV LIFE unit.

<sup>3</sup> Rules apply, refer to installation manual for details.



DAIKIN ONE+ SMART THERMOSTAT



DAIKIN ONE TOUCH SMART THERMOSTAT

COMFORTABLE LIMITED WARRANTY\* PROTECTION



\* Complete warranty details available from your local dealer/contractor or at [www.daikincomfort.com](http://www.daikincomfort.com). To receive the 10-Year Parts Limited Warranties, online registration must be completed within 60 days of installation. Online registration and some of the additional requirements are not required in California or Québec. The duration of warranty coverages in Texas differs in some cases.

**VRV LIFE**

VRV A-Coil  
CXTQ\_TASBLU



**CXTQ All Aluminum Coil**

- » Available in 2, 3, 4, and 5-Ton capacities
- » Engineered for compatibility with VRV LIFE outdoor unit
- » Factory installed electronic expansion valve with PID control loop for precision capacity control
- » Seamless integration to full suite of Daikin controls using onboard control board
- » Air cleaner and humidifier integration capable<sup>1</sup>
- » UV and rust resistant, 5VA rated thermoplastic drain pan with integrated secondary drain
- » Foil-faced insulation covers internal casing to reduce cabinet condensation
- » Split seam front for easy installation and service access
- » Light weight all aluminum evaporator coil
- » Ships factory standard up flow with easy field conversion to downflow<sup>1</sup>
- » Backed by best-in-class 10-Year Parts Limited Warranty\*  
<sup>1</sup>Rules apply, refer to installation manual for details.

VRV LIFE – INDOOR – CXTQ						
Model Name		CXTQ24TASBLU	CXTQ36TASBLU	CXTQ48TASBLU	CXTQ60TASBLU	
Power Supply		24VAC from gas furnace				
Nominal Tons		2	3	4	5	
*1,*3 Cooling Capacity	Btu/h (kW)	24,000 (7.0)	36,000 (10.6)	48,000 (14.1)	60,000 (17.6)	
*2,*3 Heating Capacity	Btu/h (kW)	27,000 (7.9)	40,000 (11.7)	54,000 (15.8)	66,000 (19.4)	
Casing / Color		Daikin Slate Gray				
Dimensions (H x W x D)		22-1/16 x 17-23/32 x 24-7/32 (560 x 450 x 615)	22-1/16 x 17-23/32 x 24-7/32 (560 x 450 x 615)	30-1/16 x 21-7/32 x 24-7/32 (764 x 539 x 615)	30-1/16 x 24-23/32 x 24-7/32 (764 x 628 x 615)	
Coil	Type	Cased Upflow/Downflow A-coil				
	*4 Air pressure drop	in. w.g.	0.089"	0.240"	0.310"	0.329"
Weight		lbs. (kg)	46 (20.9)	52 (23.6)	72 (32.7)	79 (35.8)
Pipe Connections	Liquid	in. (mm)	3/8" (9.5)	3/8" (9.5)	3/8" (9.5)	3/8" (9.5)
	Gas	in. (mm)	5/8" (15.8)	5/8" (15.8)	5/8" (15.8)	5/8" (15.8)
	Drain	in. (mm)	3/4" (19.1)	3/4" (19.1)	3/4" (19.1)	3/4" (19.1)
Safety Devices		Fuse				
Refrigerant Control		Electronic Expansion Valve				
Connectible Outdoor Unit		R-410A VRV LIFE				

VRV LIFE







# Unitary Products



# Daikin One+ Smart Thermostat



## The first smart thermostat to offer full two-way communications with Daikin HVAC systems

The Daikin One+ smart thermostat is an intelligent home air controller from the world's leading heating, ventilating, and air conditioning (HVAC) manufacturer. It is a cloud-connected hub of sophistication, integrated for controlling temperature, humidity, and air quality.



visualize the air

A full-featured mobile companion app is available for Android and iOS.

- 1 **The high-resolution color touch screen display** is protected by the same toughened glass used in smart phones.

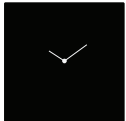

A number of screen savers are available, including this analog clock.

- 2 **The anodized aluminum bezel and dial** are precision manufactured. The surfaces have a fine bead blast with a warm hued anodized finish. The dial rotation is extraordinarily smooth because it rests on a bearing assembly typically found in precision instruments. A switch behind the dial enables users to return to the home screen from any menu with a single tap.



Turning the dial changes the temperature set point.

- 3 **An integrated Wi-Fi radio** connects to the internet (via a home router) to the cloud and on to the homeowner mobile application. The Daikin cloud will also seamlessly integrate with open smart home architectures, including *Amazon Alexa* and *Google Assistant*, enabling consumers to effortlessly use features such as voice control.



- 4 **A thin LED light bar** sits flush within the bottom surface and runs from edge to edge, delicately illuminating the wall beneath. Emitting a soft emotive glow, the light strip indicates the current system mode: red-orange for heating, blue for cooling.



- 5 **Built-in bubble level** aids professional installation.



COMFORTABLE LIMITED WARRANTY\* PROTECTION



\* Complete warranty details available from your local dealer/contractor or at [www.daikincomfort.com](http://www.daikincomfort.com). To receive the 12-Year<sup>1</sup> Limited Warranty, online registration must be completed within 60 days of installation. Online registration is not required in California or Québec. The duration of warranty coverages in Texas differs in some cases.

<sup>1</sup> 12-Year Limited Warranty is available for owner-occupied residences only. For multi-family and/or commercial applications, the warranty period is 5 years.

# Daikin One+ Smart Thermostat



The **home screen** displays the current temperature, the current system mode, and adjustment slider, as well as icons leading to the top level screens.

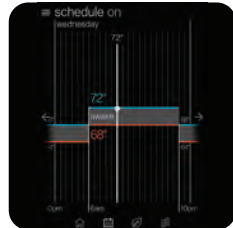

The **schedule screen** displays upcoming set-point changes and scheduled times. It also offers access to edit mode, where you can adjust the schedule.



The **away screen** displays energy saving set-points. Energy saving can be invoked manually or automatically when the mobile app recognizes everyone is away.



The **air quality screen\*** displays indoor air quality levels when a Daikin One home air monitor is connected. Outdoor air quality and weather will be displayed when connected to the internet and thermostat added in the mobile app under home location.

## The One for Connectivity

The Daikin One+ smart thermostat is a cloud-connected hub of sophistication, designed for controlling temperature, humidity, and air quality. With a variety of connectivity options, there's a comfort solution for every project and customer.

EQUIPMENT COMPATIBLE		
Equipment Type	Equipment Part Number	Compatible Model
Air Conditioners	DX9VC, DX7TC, Daikin Fit (DX6VS)	DTST-CWBSA-NI-A
Heat Pumps	DZ9VC, DZ7TC, Daikin Fit (DZ6VS)	DTST-CWBSA-NI-A
Gas Furnaces	DM97MC, DC97MC, DM96VC, DC96VC, DM96SC, DM80VC, DC80VC, DM80SC	DTST-CWBSA-NI-A
Air Handlers	DFVE, DMVE, DMVT, MBVC	DTST-CWBSA-NI-A
Single & Multi-Zone	CDXS, CTXS, FDXS, FTK_N, FTX_N, FTX_U, FTXG*, FTXR, FTXS, FVXS	DTST-ONE-ADA-A
Single & Multi-Zone (P1P2)	FDMQ, FFO	DTST-ONE-ADA-A
VRV & VRV LIFE (P1P2)	CXTQ, FXAQ, FXDQ, FXEQ, FXFQ, FXHQ, FXLQ, FXMQ, FXNQ, FXSQ, FXTQ, FXUQ, FXZQ	DTST-ONE-ADA-A
SkyAir (P1P2)	FAQ, FBO, FTQ, FCQ, FHQ	DTST-ONE-ADA-A
Indoor Air Quality	Daikin One Home Air Monitor (Only compatible with ducted units) -DSEN-HAQA	DTST-CWBSA-NI-A, DTST-ONE-ADA-A

\*The Sarara drying function of the QUATERNITY units is not supported with the Daikin One+ Smart Thermostat, but the dehumidification function of the Daikin One+ can be used with the QUATERNITY indoor units.

## Daikin One+ Specifications

### Technical Specifications

- » Analog dial
- » Capacitive touch screen
- » Backlit, 3.5 inch MVA TFT LCD display
- » Bi-directional communications protocol for controlling HVAC system
- » Bubble level (to aid installation)
- » 640 × 480 pixels × 24 bit RGB (full color screen)
- » Light pipe indicates heating or cooling
- » Wi-Fi

### Dimensions

- » Length: 6-3/4 inches
- » Height: 3-3/8 inches
- » Depth: 1-3/16 inches
- » Weight: 10.5 ounces



ACCESSORIES
Flush Mount Kit (DKIT-FLSH-ONE)
J-box Adaptor Plate Kit (DKIT-CONV-ONE)

Control is available through popular voice-activated speakers.



Google, Google Assistant, and all related logos are trademarks of Google, or its affiliates. Amazon, Alexa, and all related logos are trademarks of Amazon.com, Inc. or its affiliates.

UNITARY PRODUCTS



# Daikin *One Touch* Smart Thermostat

COMFORTABLE LIMITED  
WARRANTY\* PROTECTION



\* Complete warranty details available from your local dealer/contractor or at [www.daikincomfort.com](http://www.daikincomfort.com). To receive the 12-Year<sup>1</sup> Limited Warranty, online registration must be completed within 60 days of installation. Online registration is not required in California or Québec. The duration of warranty coverages in Texas differs in some cases.

<sup>1</sup> 12-Year Limited Warranty is available for owner-occupied residences only. For multi-family and/or commercial applications, the warranty period is 5 years.

## Say hello to the Daikin *One touch* smart thermostat.

The Daikin *One touch* smart thermostat is the newest addition to the Daikin *One* ecosystem line of products, joining the Daikin *One+* smart thermostat as a control solution for Daikin's communicating unitary equipment, including Daikin *Fit*.

With customizable settings and the power to wirelessly control heating and cooling from anywhere, homeowners may never want to change their thermostat manually again. However, the touchscreen interface supports a user-friendly experience when they do. Additionally, voice control is possible with compatible Amazon and Google devices. Plus, every Daikin *One touch* includes one year of Daikin *One* cloud services at no added cost, allowing contractors to support their customers' systems remotely and offer homeowners additional peace of mind!

### Standard Features

- » Simple, elegant industrial design
- » Capacitive touchscreen user interface
- » Wi-Fi-enabled smart thermostat with iOS and Android app control
- » Voice control by *Amazon Alexa* and *Google Assistant*
- » Control and comfort functions: Away mode, geo-fencing
- » Outdoor environment monitoring: outdoor temperature, outdoor humidity, and weather forecast
- » Compatible with Daikin *One* home air monitor for IAQ visualization
- » Error and service notifications
- » Multi-language support: English, Spanish, and French
- » Programmable 4-event schedule with adjustable hold function
- » Compatible with Daikin *One* cloud services



A full-featured mobile companion app is available for Android and iOS.

### DAIKIN *ONE TOUCH* SMART THERMOSTAT SPECIFICATIONS:

<b>Model Number</b>	DTST-TOU-A
<b>Description</b>	Daikin <i>One touch</i> smart thermostat
<b>Dimensions</b>	0.86"L x 3.4"W x 4.74"H
<b>Weight</b>	6.5 oz
<b>Operation Temperature</b>	32°F to 120°F
<b>Thermostat Compliance</b>	Compliant to California Title 24 (OCST listed), FCC Certified, and UL Listed.



The **home screen** displays the current temperature, the current system mode, and adjustment slider, as well as icons leading to the top level screens.

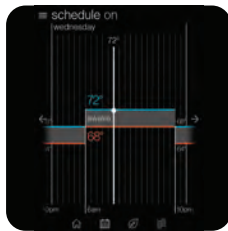

The **schedule screen** displays upcoming set-point changes and scheduled times. It also offers access to edit mode, where you can adjust the schedule.



The **away screen** displays energy saving set-points. Energy saving can be invoked manually or automatically when the mobile app recognizes everyone is away.



The **air quality screen\*** displays indoor air quality levels when a Daikin *One* home air monitor is connected. Outdoor air quality and weather will be displayed when connected to the internet and thermostat added in the mobile app under home location.

\*Actual screen may vary for different indoor unit models. The Daikin *One* home air monitor only works with ducted units.





\* Complete warranty details available from your local dealer/contractor or at [www.daikincomfort.com](http://www.daikincomfort.com). To receive the 12-Year Parts Limited Warranty, online registration must be completed within 60 days of installation. Online registration and some of the additional requirements are not required in California or Québec. The duration of warranty coverages in Texas differs in some cases.

## Daikin One Premium Air Cleaner

- » Magnetic door design ensures tool-less, easy access to filter components for quick and easy filter changes
- » Insulated cabinet to reduce risk of condensation.
- » The new Daikin One premium air cleaner is a MERV 15 media filter that removes more than 85% of particles down to 0.3 microns\*
- » Pleated media filter removes over 98% of Aspergillus fumigatus, Aspergillus versicolor, and Stachybotrys chartarum from the airstream\*
- » Pleated media filter removes over 99% of Ragweed, over 72% of Cat Dander, and over 73% of Dust Mites from the airstream\*
- » Extra deep, 5¼" pleated filter constructed of cellulose-free, hydrophobic polyolefin fibers
- » Designed for multi-position horizontal or vertical installations
- » Room Temperature Catalyst Degrades formaldehyde and ozone
- » Filter design features a structured density gradient for sustained efficiency over the life of the filter
- » Room Temperature Catalyst: Helps remove formaldehyde and ozone
- » Filter has a tight cabinet fit ensuring negligible air bypass
- » Filter frame designed with dual pull tabs for easy removal
- » Fully gasketed door for proper air seal



ROOM TEMPERATURE CATALYST

- » Heavy duty, 20 gauge, post-forming painted, corrosion-resistant door
- » All cabinet mounting holes are slotted and designed to line-up with original equipment flanges for time-saving installation
- » Filter should be changed once or twice a year based on conditions within the home

\*Independent testing performed by LMS Technologies, Inc.

SPECIFICATIONS	MODEL	DV1-15-2117-AB	DV1-15-2121-AC	DV1-15-2124-AD	DV1-15-2814-FA	DV1-15-2817-FB	DV1-15-2821-FC	DV1-15-2824-FD
Airflow - up to maximum rated flow		Up to 1200 cfm (2039 m <sup>3</sup> /h)	Up to 1600 cfm (2718 m <sup>3</sup> /h)	Up to 1800 cfm (3058 m <sup>3</sup> /h)	Up to 1200 cfm (2039 m <sup>3</sup> /h)	Up to 1600 cfm (2718 m <sup>3</sup> /h)	Up to 2000 cfm (3398 m <sup>3</sup> /h)	Up to 2000 cfm (3398 m <sup>3</sup> /h)
Duct Size		21 x 17 in (53 x 43 cm)	21 x 21 in (53 x 53 cm)	21 x 24 in (53 x 61 cm)	28 x 14 in (71 x 36 cm)	28 x 17 in (71 x 43 cm)	28 x 21 in (71 x 53 cm)	28 x 24 in (71 x 61 cm)
Pressure Drop* (Filter Only)		0.11 in. w.g. @ 600 cfm 0.26 in. w.g. @ 1200 cfm	0.11 in. w.g. @ 800 cfm 0.31 in. w.g. @ 1600 cfm	0.11 in. w.g. @ 900 cfm 0.27 in. w.g. @ 1800 cfm	0.10 in. w.g. @ 600 cfm 0.27 in. w.g. @ 1200 cfm	0.10 in. w.g. @ 800 cfm 0.26 in. w.g. @ 1600 cfm	0.10 in. w.g. @ 1000 cfm 0.24 in. w.g. @ 2000 cfm	0.09 in. w.g. @ 1000 cfm 0.19 in. w.g. @ 2000 cfm
MERV Rating*		15	15	15	15	15	15	15

**Notes:**

1. Installation with units with ECM motors recommended.
2. Two filters should be considered for any airflow rates above maximum rated flow or when duct pressure loss is excessive.

Furnace Size	A	B	C	D
Furnace Riser	AMP-BSRB-1428	AMP-BSRB-1728	AMP-BSRB-2128	AMP-BSRB-2428

When using a furnace riser use DV1-2824-FD on all size furnaces

MERV Rating 15 - Minimum Filtration Efficiency @ 492 fpm • E1 85% (0.3 - 1.0 micron) • E2 90% (1.0 - 3.0 microns) • E3 95% (3.0 - 10.0 microns)

\*Independent testing performed by LMS Technologies, Inc. Specification values may vary due to individual systems.



Furnace Riser

DIMENSIONS (IN)								
MODEL	A	B1	B2	C	D	E	F	G
DV1-15-2117-AB	17.5	21.1	21.7	1.4	0.8	1.3	14.7	19.4
DV1-15-2121-AC	21.0	21.1	21.7	1.4	0.8	1.3	18.2	19.4
DV1-15-2124-AD	24.5	21.1	21.7	1.4	0.8	1.3	21.7	19.4
DV1-15-2814-FA	14.0	28.0	28.6	0.8	0.8	3.8	12.5	23.9
DV1-15-2817-FB	17.5	28.0	28.6	0.8	0.8	3.8	16.0	23.9
DV1-15-2821-FC	21.0	28.0	28.6	0.8	0.8	3.8	19.5	23.9
DV1-15-2824-FD	24.5	28.0	28.6	0.8	0.8	3.8	23.0	23.9

### Replacement Media Filters

AIR CLEANER MODEL (1)	REPLACEMENT MERV 15 FILTER PART (2)	REPLACEMENT ROOM TEMPERATURE CATALYST (RTC)
DV1-15-2117-AB	0160M00013	DVFC-AB
DV1-15-2121-AC	0160M00014	DVFC-AC
DV1-15-2124-AD	0160M00015	DVFC-AD
DV1-15-2814-FA	0160M00016	DVFC-FA
DV1-15-2817-FB	0160M00017	DVFC-FB
DV1-15-2821-FC	0160M00018	DVFC-FC
DV1-15-2824-FD	0160M00019	DVFC-FD

Filter should be changed once or twice a year based on conditions within the home. RTC should be changed once every six months based on conditions within the home.

(1) EPA EST. NO. 073316-TEX-001 • (2) EPA EST. NO. 71027-MEX-001

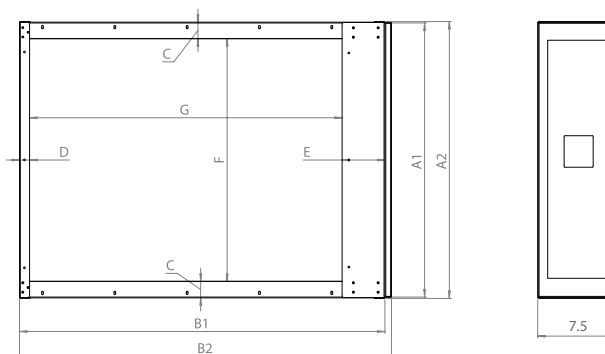

\*Independent testing performed by LMS Technologies, Inc.

UNITARY PRODUCTS

# Daikin One

## Powered Ventilator

### DQ-P-16-100

COMFORTABLE LIMITED WARRANTY\* PROTECTION



\* Complete warranty details available from your local dealer/contractor or at [www.daikincomfort.com](http://www.daikincomfort.com). Warranty registration not required to receive the 5-Year parts limited warranty for residential or commercial installations. The duration of warranty coverages in Texas differs in some cases.

## Daikin One Powered Ventilator

The Daikin *One* powered ventilator is a cost-effective mechanical ventilation solution that helps manage the humidity and temperature in a home. Contractors and builders now have a practical offering for supplying constant outdoor air into the residence, meeting the ventilation requirements per ASHRAE 62.2 guidelines.

- » Includes a MERV 16 filter that helps eliminate almost all airborne particulates from the incoming air stream (Optional MERV 13 filters available)
- » Delivers between 40 and 100 CFM<sup>1</sup> of air to the home, adjustable in 10 CFM increments
- » Adjustable climate control limits prevent air from entering the house when the on board sensors detect temperature or humidity outside of selected ranges
- » Compact and versatile design: can be wall or ceiling-mounted in an attic, basement, garage or crawl space
- » HVI Certified performance
- » Cost-effective mechanical ventilation for homes
- » Low operational sound levels
- » Durable, white epoxy finish
- » Suitable for use in single and/or multi-family projects

<sup>1</sup>When MERV 16 is used



Table 1 - Power consumption of Ventilator at various flowrates	
Flow Rate @ 0.2" w.c.	
(CFM)	Power (W)
100	26.3
90	21.8
80	19.5
70	17.1
60	15.1
50	13
40	11.3

### Blower Wheel

- » Balanced polymeric dual inlet blower wheel secured in place using a hex nut.

### Adjustable Capacity Motor

- » 7 settings allow the ventilator to be set to the required intake flowrate.
  - Set-points include: 40, 50, 60, 70, 80, 90, and 100 CFM
  - 4 pole motor, permanently lubricated
  - 115/120 VAC, 60 Hz, 0.30 A.

### Controller

- » Unit mounted controller monitors temperature and humidity of incoming air and allows installer to configure ventilation flowrate and temperature and humidity limits for intake air.

### Fan Housing

- » Insulated 26 gauge baked epoxy housing. Overall dimensions: 14<sup>3</sup>/<sub>8</sub>" H x 11<sup>1</sup>/<sub>2</sub>" D x 10<sup>1</sup>/<sub>8</sub>" W (37.6cm H x 29.2cm D x 25.7cm W).

### Duct Collars

- » 6" round, zinc plated metal collar adaptors.

### Electrical Connections

- » Unit is designed to be easily hard wired in the field

### Filter Information

- » Ventilator ships with 10" H x 10" W x 2" D (25.4 cm H x 25.4 W cm x 5.1 cm D) MERV 16 intake air filter. Optional MERV 13 filter (purchased separately) available as an after market service component.

### Test Port

- » Allows easy air flow measurement with Pitot tube or similar airflow measurement device.

### Single Pack Shipping Info

- » Shipping carton dimensions: 15<sup>3</sup>/<sub>4</sub>" H x 12<sup>3</sup>/<sub>4</sub>" W x 23" D (40 cm H x 32.4 cm W x 58.4 cm D)
- » Shipping weight: 18 lbs (3.85 kg)

### Ventilator Accessories

The capabilities of the Daikin *One* Powered Ventilator can be enhanced by adding any of the following optional accessories (sold separately):

- » Heater (70 CFM & Higher) DQ-P-70-AH-H
- » Motorized Damper kit DQ-P-MDV
- » Air Intake Hood DQ-P-AIH

COMFORTABLE LIMITED WARRANTY\* PROTECTION



\* Complete warranty details available from your local dealer contractor or at [www.daikincomfort.com](http://www.daikincomfort.com). To receive the 1-Year Unit Replacement Limited Warranty, online registration must be completed within 60 days of installation. Online registration is not required in California or Québec. The duration of warranty coverages in Texas differs in some cases.

**Daikin One**  
Home Air Monitor  
DSEN-HAQA

The Daikin *One* home air monitor helps monitor the air quality within the whole home. Working with the Daikin *One* ecosystem, it detects, visualizes, and supports action to help you improve the indoor air quality within your space.

**Detect**

- » The Daikin *One* home air monitor will monitor and learn baseline air quality in the home, over 7 days, then provide a rolling 7-day average baseline.
- » When potential particulate and/or chemical events occur outside of this average baseline, the system will detect the potential deviation and send alerts to the Daikin *One+* or Daikin *One* touch smart thermostat.

**Visualize**

- » From the Daikin *One+* or Daikin *One* touch smart thermostat, visualize the estimated air quality in real-time directly on the thermostat or through the smartphone app.
- » Indoor Air Quality Event Monitor – from this option, see when particles or chemicals are elevated compared to the 7-day baseline to help to understand and control your air. The readings will include:
  - **Green** - typical concentrations in the home
  - **Yellow** - elevated concentrations in the home
  - **Orange** - very elevated concentrations in the home

**Act:**

- » With built-in Air Intelligence, the Daikin *One* home air monitor and Daikin *One* ecosystem provide adaptive solutions homeowners advance through their Daikin *One+* or Daikin *One* touch smart thermostat based on air quality alerts.
  - Turn on the furnace or air handler to increase filtration through the high-efficiency Daikin *One* premium air cleaner to address particles.
  - Turn on exhaust/ventilation or open a window to help reduce detected chemicals within the home.

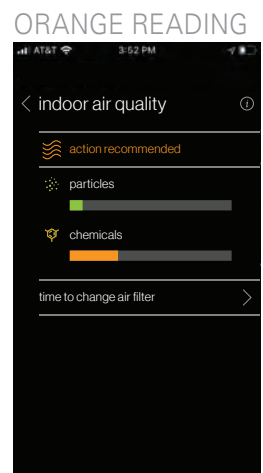
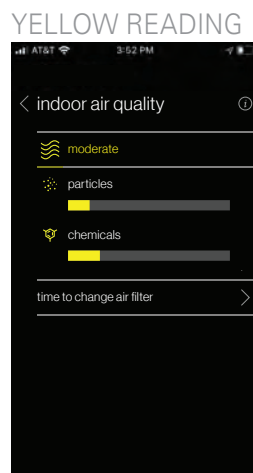
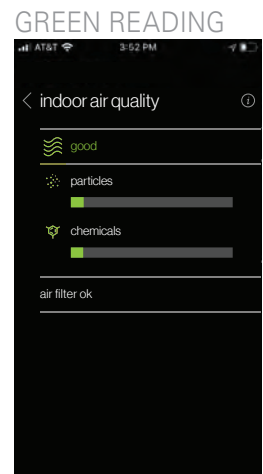
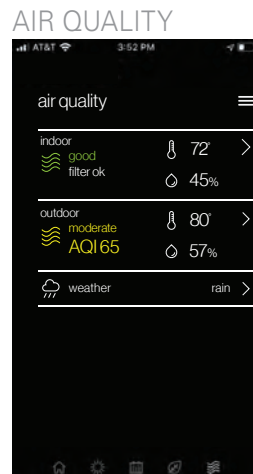

UNITARY PRODUCTS

# Daikin *Fit* System

## DX6VS / DZ6VS

Quiet / Space-Saving / Efficient

COMFORTABLE LIMITED WARRANTY\* PROTECTION



\* Complete warranty details available from your local dealer/contractor or at [www.daikincomfort.com](http://www.daikincomfort.com). To receive the 12-Year Unit Replacement Limited Warranty and 12-Year Parts Limited Warranty, online registration must be completed within 60 days of installation. The duration of warranty coverages in Texas differs in some cases.

Additional requirements for annual maintenance are required for the Unit Replacement Limited Warranty. Online registration and some of the additional requirements are not required in California or Québec.

## Designed to fit comfort, space-saving, and efficiency requirements with ease.

**FIT** FLEXIBLE. INNOVATIVE. TECHNOLOGY. The Daikin *Fit* system is a side discharge, smart HVAC system that won't compromise on comfort and connects to ducted solutions traditional to the unitary market. In a market saturated with expensive high-tiered inverters, the system provides a premium mid-efficiency inverter at an affordable rate. The low profile of the outdoor unit offers solutions when a traditional cube style cannot.

### Daikin *Fit* System Features and Benefits

- » AC: Up to 17.2 SEER2  
Heat Pump: Up to 17.5 SEER2 and 8.5 HSPF2
- » Compact – The trunk style outdoor unit is perfect when installation space is limited
- » Inverter (variable-speed) Compressor – Ideal indoor comfort and efficiency
- » Low dBA – Reclaim outdoor space
- » Quiet-mode - provides enhanced acoustical comfort, up to 3 different sound levels (as low as 45dBA).
- » Blue Fin Coat – Long condenser coil life and reliability
- » Swing Compressor – Quiet and dependable
- » Side panel access – Ease of service
- » Lightweight – Easier to handle and install (compared to traditional cube style systems)

### Daikin *Fit* Heat Pump Features

- » Intelligent Defrost Mode – The outdoor unit will enable this mode to help prevent frost/ice from building up in cold climate conditions. It will also help with longer heating operation time for additional comfort for occupants (compared to HVAC systems without this function).
  - A selectable defrost backup heat option, when turned off, will lower power consumption during defrost.
- » Advanced water-shedding drain pan – engineered with multiple drain holes and channels to help provide effective water shedding.
- » Hot start technology – When the heating operation starts or when the unit changes from cooling to heating there is no cold draft released into the room.

#### DAIKIN *FIT* AIR CONDITIONER

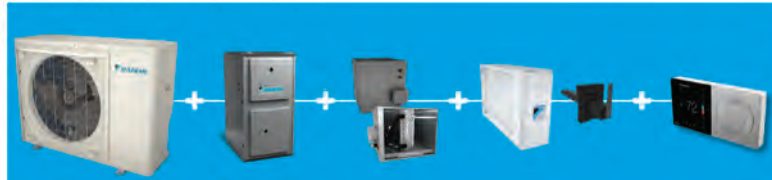

#### DAIKIN *FIT* AIR CONDITIONER



#### DAIKIN *FIT* HEAT PUMP



#### DAIKIN *FIT* HEAT PUMP WITH DUAL FUEL\*



\*Partial offering available: 1.5 to 3.0 tons with upflow/downflow coils





# Daikin *Fit* System DX6VS / DZ6VS Quiet / Space-Saving / Efficient

## Application

### A new solution for even the most unique projects

- » Perfect alternative to the traditional cube style unitary products in a 1:1 application
- » Mid-efficiency heat pumps can be applied across North America
- » Traditional homes, townhomes, bungalows, condos, zero lot line homes, patios, terrace, and multi-story locations that would typically require a crane
- » Install using existing ductwork and existing line sets
- » Space-saving low profile trunk style outdoor unit for easy carrying and installation in tight spaces
- » Ease of service and maintenance with a quick-to-access side panel
- » DFVE Air Handler with 7 mm evaporator coils
- » Utilize EEV coil families:
  - DX6VS only:
    - CAPE (Upflow/Downflow)
    - CHPE (Dedicated Horizontal)
  - DX6VS & DZ6VS:
    - CAPEA (Upflow/Downflow) with 7mm evaporator coils
- » Connects with any Daikin communicating gas furnace 80% and 90%+. When connected to the Daikin *Fit* Heat Pump, dual fuel capability is an option.
- » Compatible with the Daikin *One+* and Daikin *One* touch smart thermostats and other Daikin communicating equipment
- » Add the Daikin *One* premium air cleaner, the Daikin *One* home air monitor, or the Daikin *One* powered ventilator for additional IAQ (Indoor Air Quality) control.



## Budget

### Operational efficiencies that drive savings

The inverter compressor is the heart of a Daikin *Fit* system. Daikin's inverter technology is responsible for delivering intelligent comfort with efficiency, based on demand. The inverter (variable-speed) compressor delivers the capacity required to maintain desired room conditions, typically reducing energy consumption by up to 30% or more (compared to traditional fixed-speed systems).

- » The enhanced functionality of the variable-speed DC fan motor can offer an increase of approximately 20% in efficiency (compared to systems with a conventional AC motor).

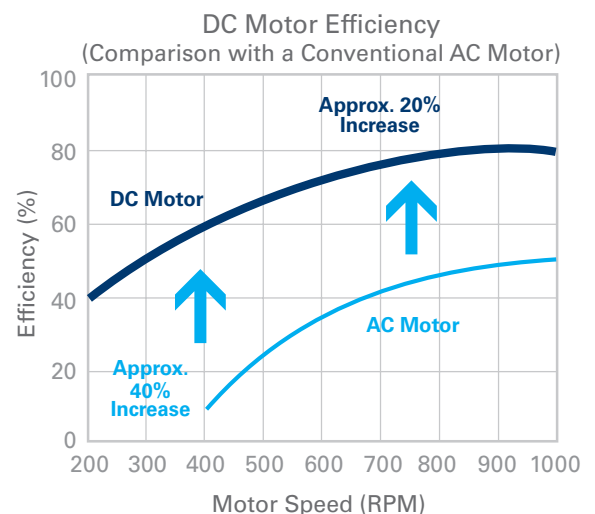

Note: Data is based on studies conducted under controlled conditions at a Daikin laboratory.

UNITARY PRODUCTS

# Daikin *Fit* System

## DX6VS / DZ6VS

Quiet / Space-Saving / Efficient

### Comfort

#### Ideal temperature and low sound levels

Traditional (non-inverter) systems offer basic ON/OFF operation mode only. With the compressor turning ON/OFF constantly, the system works to reach set indoor temperature. With inverter technology, the Daikin *Fit* system, can adjust operations to meet the desired comfort levels.

Undesirable operational sounds often accompany non-inverter (traditional) HVAC systems. These continuous sounds can become a nuisance in yards, or when the system is installed near a window. With the ability to reach sound power levels as low as 45dB(A) in quiet mode, the Daikin *Fit* system can help bring additional acoustical comfort to any environment (inside and out).

The Quiet-mode feature provides enhanced acoustical comfort, up to 3 different sound levels.

#### SOUND LEVELS AS LOW AS:

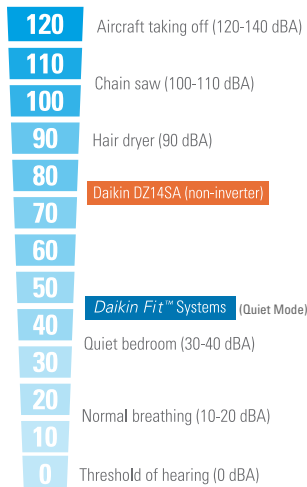

### Design

#### Compact footprint to meet design demands

Feature rich design in a compact footprint that includes:

- » Blue Fin Coat: Long condenser coil life and reliability
- » Swing Compressor: Quiet and dependable
- » Advanced Water-Shedding Drain Pan: Engineered with multiple drain holes and channels to help provide effective water shedding.

With clearance space as little as 4" from a wall and compact size, the Daikin *Fit* system works when installation space is limited.

- » Fit more in your HVAC tech van or truck; 4 – 5 Daikin *Fit* units as opposed to 1 or 2 traditional systems
- » Easy to bring to the installation site and install on pad – the single fan unit can be transported by a single worker or on a dolly

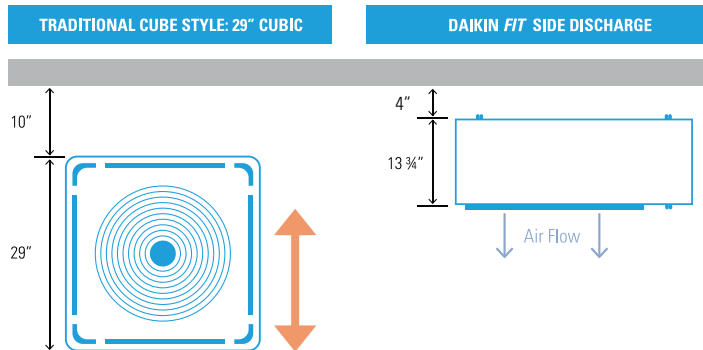

Unit Dimensions	
1.5-3 TON	3.5-5 TON
W: 36.6" x D: 13.8" x H: 27.4"	W: 37" x D: 12.6" x H: 39"

COMFORTABLE LIMITED WARRANTY\* PROTECTION



\* Complete warranty details available from your local dealer/contractor or at [www.daikincomfort.com](http://www.daikincomfort.com). To receive the 12-Year Unit Replacement Limited Warranty and 12-Year Parts Limited Warranty, online registration must be completed within 60 days of installation. The duration of warranty coverages in Texas differs in some cases.

Additional requirements for annual maintenance are required for the Unit Replacement Limited Warranty. Online registration and some of the additional requirements are not required in California or Québec.

Daikin *Fit* Air Conditioner  
DX6VS

DAIKIN FIT- AC OUTDOOR UNIT											
Model Name	DX6VSS 1810A*	DX6VSS 2410A*	DX6VSS 3010A*	DX6VSS 3610A*	DX6VSS 4210A*	DX6VSS 4810A*	DX6VSS 6010A*	DX6VSA 181WA*	DX6VSA 241WA*	DX6VSA 301WA*	DX6VSA 361WA*
<b>Capacities (AHRI Rated)<sup>1</sup></b>											
Max. Cooling (BTU/h)	16,600	22,200	27,800	33,600	39,500	45,000	53,000	16,600	22,200	27,800	32,400
<b>Ambient Operation Range</b>	0 to 115 (-17.8 to 46.1)										
Cooling (°FDB(°CDB))											
<b>Compressor</b>											
Type	Swing	Swing	Swing	Swing	Swing	Swing	Swing	Swing	Swing	Swing	Swing
RLA	10.0	13.4	16.8	16.8	25.5	25.5	26.9	10.0	13.4	16.8	16.8
<b>Condenser Fan Motor</b>											
Horsepower (HP)	0.09	0.09	0.20	0.20	0.36	0.36	0.36	0.09	0.09	0.20	0.20
FLA	1.15	1.15	2.00	2.00	1.63	1.63	1.63	1.15	1.15	2.00	2.00
<b>Refrigeration System</b>											
Refrigerant Line Size											
Liquid Line Size ("O.D.)	3/8"	3/8"	3/8"	3/8"	3/8"	3/8"	3/8"	3/8"	3/8"	3/8"	3/8"
Suction Line Size ("O.D.)	3/4"	3/4"	7/8"	7/8"	1 1/8"	1 1/8"	1 1/8"	3/4"	3/4"	7/8"	7/8"
Refrigerant Connection Size											
Liquid Valve Size ("O.D.)	3/8"	3/8"	3/8"	3/8"	3/8"	3/8"	3/8"	3/8"	3/8"	3/8"	3/8"
Suction Valve Size ("O.D.)	3/4"	3/4"	7/8"	7/8"	7/8"	7/8"	7/8"	3/4"	3/4"	7/8"	7/8"
Valve Connection Type	Front Sealing	Front Sealing	Front Sealing	Front Sealing	Front and Back Sealing	Front and Back Sealing	Front and Back Sealing	Front Sealing	Front Sealing	Front Sealing	Front Sealing
Refrigerant Charge (oz.)	76	76	79	85	111	111	131	76	76	79	85
Expansion Device	EEV	EEV	EEV	EEV	EEV	EEV	EEV	EEV	EEV	EEV	EEV
Superheat at Service Valve	Auto-Control	Auto-Control	Auto-Control	Auto-Control	Auto-Control	Auto-Control	Auto-Control	Auto-control	Auto-control	Auto-control	Auto-control
Subcooling at Service Valve	10±1°F	12±1°F	14±1°F	15±1°F	8±1°F	9±1°F	9±1°F	10±1°F	12±1°F	14±1°F	13±1°F
<b>Electrical Data</b>											
Voltage / Phase (60 Hz)	208-230/1	208-230/1	208-230/1	208/230-1	208/230-1	208-230/1	208-230/1	208-230/1	208-230/1	208-230/1	208-230/1
Minimum Circuit Ampacity <sup>2</sup>	14.6	18.8	23.9	23.9	34.4	34.4	36.2	14.6	18.8	23.9	23.9
Max. Overcurrent Protection <sup>3</sup>	15	20	25	25	35	35	40	15	20	25	25
Min / Max Volts	197/253	197/253	197/253	197/253	197/253	197/253	197/253	197/253	197/253	197/253	197/253
Electrical Conduit Size	1/2"	1/2"	1/2"	1/2"	1/2 or 3/4"	1/2 or 3/4"	1/2 or 3/4"	1/2"	1/2"	1/2"	1/2"
<b>Equipment Weight (lbs)</b>	119	119	129	133	163	163	174	119	119	129	133
<b>Ship Weight (lbs)</b>	133	133	143	148	183	183	196	133	133	143	148

<sup>1</sup> Testing and rated in accordance with ANSI/AHRI Standard 210/240

<sup>2</sup> Wire size should be determined in accordance with National Electrical Codes; extensive wire runs will require larger wire sizes

<sup>3</sup> Must use time-delay fuses or HACR-type circuit breakers of the same size as noted.

**Notes**

Always check the S&R plate for electrical data on the unit being installed.

Unit is charged with refrigerant for 15' of 3/8" liquid line. System charge must be adjusted per Installation Instructions Final Charge Procedure.

DAIKIN D24V GATEWAY – ADAPTOR FOR DAIKIN FIT AC / 24V FURNACE SYSTEMS\*

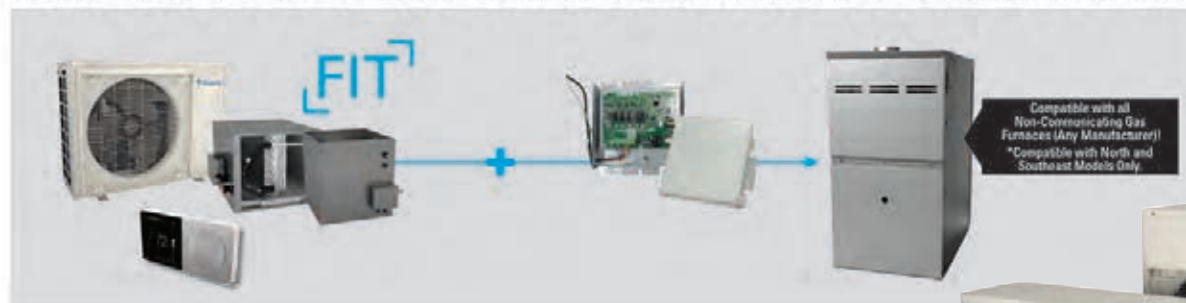

When a full system replacement is not a chosen option, a partial Daikin *Fit* AC system is now a possibility. Also, the D24V Gateway offers a great comfort upgrade solution or homes with only heating/furnaces.

Enjoy the fantastic features and benefits of Daikin *Fit* inverter side discharge unitary outdoor unit, EEV coil and Daikin *One+* Smart Thermostat. Benefits include field selectable dehumidification settings to accommodate customer preferences and ability to add Daikin *One* ecosystem indoor air quality accessories. Part Number: DTA11A71.

# Daikin *Fit* Heat Pump DZ6VS

## COMFORTABLE LIMITED WARRANTY\* PROTECTION



\* Complete warranty details available from your local dealer/contractor or at [www.daikincomfort.com](http://www.daikincomfort.com). To receive the 12-Year Unit Replacement Limited Warranty and 12-Year Parts Limited Warranty, online registration must be completed within 60 days of installation. The duration of warranty coverages in Texas differs in some cases.

Additional requirements for annual maintenance are required for the Unit Replacement Limited Warranty. Online registration and some of the additional requirements are not required in California or Québec.



### DAIKIN *Fit* - HEAT PUMP OUTDOOR UNIT

Model Name	DZ6VSA 1810A*	DZ6VSA 2410A*	DZ6VSA 3010A*	DZ6VSA 3610A*	DZ6VSA 4210A*	DZ6VSA 4810A*	DZ6VSA 6010A*
<b>Capacities (AHRI Rated)<sup>1</sup></b>							
Max. Cooling (BTU/h)	16,600	22,200	27,800	33,600	39,500	45,000	53,000
Max. Heating (BTU/h)	17,400	23,200	28,800	34,600	40,000	45,500	54,500
<b>Ambient Operation Range</b>	0 to 115 (-17.8 to 46.1)						
Cooling (°F DB(°C DB))	-10 to 70 (-23.3 to 21.1)						
Heating (°F DB(°C DB))							
<b>Compressor</b>							
Type	Swing Compressor	Swing Compressor	Swing Compressor	Swing Compressor	Swing Compressor	Swing Compressor	Swing Compressor
RLA	10.0	13.4	16.8	16.8	25.5	25.5	26.9
<b>Condenser Fan Motor</b>							
Horsepower (HP)	0.09	0.09	0.20	0.20	0.36	0.36	0.36
FLA	1.15	1.15	2.00	2.00	1.63	1.63	1.63
<b>Refrigeration System</b>							
Refrigerant Line Size							
Liquid Line Size ("O.D.)	3/8"	3/8"	3/8"	3/8"	3/8"	3/8"	3/8"
Suction Line Size ("O.D.)	3/4"	3/4"	7/8"	7/8"	1 1/8"	1 1/8"	1 1/8"
Refrigerant Connection Size							
Liquid Valve Size ("O.D.)	3/8"	3/8"	3/8"	3/8"	3/8"	3/8"	3/8"
Suction Valve Size ("O.D.)	3/4"	3/4"	7/8"	7/8"	7/8"	7/8"	7/8"
Valve Connection Type	Front Sealing	Front Sealing	Front Sealing	Front Sealing	Front and Back Sealing	Front and Back Sealing	Front and Back Sealing
Refrigerant Charge (oz.)	81	81	88	88	118	118	127
Expansion Device	EEV	EEV	EEV	EEV	EEV	EEV	EEV
Superheat at Service Valve	Auto-control	Auto-control	Auto-control	Auto-control	Auto-control	Auto-control	Auto-control
Subcooling at Service Valve	10±1°F	12±1°F	14±1°F	15±1°F	8±1°F	9±1°F	9±1°F
<b>Electrical Data</b>							
Voltage / Phase (60 Hz)	208-230/1	208-230/1	208-230/1	208-230/1	208-230/1	208-230/1	208-230/1
Minimum Circuit Ampacity <sup>2</sup>	14.6	18.8	23.9	23.9	34.4	34.4	36.2
Max. Overcurrent Protection <sup>3</sup>	15	20	25	25	35	35	40
Min / Max Volts	197/253	197/253	197/253	197/253	197/253	197/253	197/253
Electrical Conduit Size	1/2"	1/2"	1/2"	1/2"	1/2" or 3/4"	1/2" or 3/4"	1/2" or 3/4"
<b>Equipment Weight (lbs)</b>	122	122	132	137	168	168	179
<b>Ship Weight (lbs)</b>	137	137	147	151	185	185	198

<sup>1</sup> Tested and rated in accordance with AHRI Standard 210/240.

<sup>2</sup> Wire size should be determined in accordance with National Electrical Codes; extensive wire runs will require larger wire sizes.

<sup>3</sup> Must use time-delay fuses or HACR-type circuit breakers of the same size as noted.

#### Notes:

Always check the S&R plate for electrical data on the unit being installed.

/ System charge must be adjusted per Installation Instructions Final Charge Procedure.



COMFORTABLE LIMITED WARRANTY\* PROTECTION



\* Complete warranty details available from your local dealer/contractor or at [www.daikincomfort.com](http://www.daikincomfort.com). To receive the 12-Year Parts Limited Warranty, online registration must be completed within 60 days of installation. Online registration is not required in California or Québec. The duration of warranty coverages in Texas differs in some cases.

Daikin *Fit* Air Handler

DFVE

Multi-Position, Variable-Speed

Standard Features

- » Electronic Expansion Valve (EEV) for cooling and heat pump applications.
- » 7mm evaporator coil tube size
- » Variable-speed ECM blower motor
- » Compatible with the Daikin *One+* and Daikin *One* touch smart thermostats and other Daikin communicating equipment
- » Provides constant CFM over a wide range of static pressure conditions independent of duct system
- » CFM indicator
- » Thermostat provides adjustable low CFM for efficient fan-only operation
- » All-aluminum evaporator coil
- » Fault recall of six most recent faults
- » Improved humidity and comfort control
- » AHRI certified; ETL listed



The Daikin brand DFVE Multi-Position, Variable-Speed Air Handler is part of our family of communicating units and optimized for use with the chlorine-free refrigerant, R-410A. This unit's ECM indoor blower motor allows for a soft start and stop, which offers a quiet, efficient operation and helps reduce the cold blast of air upon heating start-up.

Model	Nominal Capacity Range (tons)	Voltage	MCA	MOP	Dimensions			Connection Size		Ship Weight (lbs)
					W"	D"	H"	Liquid"	Suction"	
DFVE24BP1400	2	208/230-1	4.9/4.9	15/15	17½	21	45	¾"	¾"	115
DFVE36CP1400	3	208/230-1	6.5/6.5	15/15	21	21	53⅞	¾"	¾"	140
DFVE42CP1400	3½	208/230-1	6.5/6.5	15/15	21	21	53⅞	¾"	¾"	140
DFVE48DP1400	4	208/230-1	6.5/6.5	15/15	24½	21	53⅞	¾"	¾"	150
DFVE60DP1400	5	208/230-1	6.5/6.5	15/15	24½	21	58	¾"	¾"	167

The manufacturing entity reserves the right to discontinue, or change at any time, specifications or designs without notice or without incurring obligations.



DAIKIN *ONE+* SMART THERMOSTAT



DAIKIN *ONE* TOUCH SMART THERMOSTAT

## Daikin *Fit* – Coils

### CAPEA / CAPE / CHPE

#### All Aluminum Coils

### CAPEA / CAPE / CHPE All Aluminum Coils

- » Available in 1.5-Ton through 5-Ton capacities
- » Engineered for compatibility with Daikin *Fit* outdoor units
- » Electronic Expansion Valve (EEV) models feature
  - Compatibility with the Daikin *One+* and Daikin *One* touch smart thermostats and other Daikin communicating equipment
  - Cooling and heat pump applications
  - Fault recall of six most recent faults
  - PID control loop for precision capacity control
- » Seamless integration to full suite of Daikin controls using communicating control board
- » Light weight all aluminum evaporator coil
  - 7mm evaporator coil tube size (CAPEA)
- » Air cleaner and humidifier integration capable (rules apply, refer to installation manual for details).
- » UV and rust resistant, 5VA rated thermoplastic drain pan with integrated secondary drain
- » Foil-faced insulation covers internal casing to reduce cabinet condensation



- » Split seam front for easy installation and service access (except for CAPEA)
- » Ships factory standard up flow with easy field conversion to downflow (CAPEA & CAPE)
- » CHPE is for horizontal applications

#### CAPEA – Utilized by DX6VS & DX6VS

Model	Dimensions			Nominal Capacity Range (tons)	Connection Size		Ship Weight (lbs)
	W"	D"	H"		Liquid"	Suction"	
CAPEA1818B4	17½	21	18	1½ - 2	¾	¾	43
CAPEA1818C4	21	21	18	1½ - 2	¾	¾	45
CAPEA2422B4	17½	21	22	2 - 2½	¾	¾	48
CAPEA2422C4	21	21	22	2 - 2½	¾	¾	51
CAPEA3026B4	17½	21	26	3	¾	¾	54
CAPEA3026C4	21	21	26	3	¾	¾	57
CAPEA3026D4	24½	21	26	3	¾	¾	62

The manufacturing entity reserves the right to discontinue, or change at any time, specifications or designs without notice or without incurring obligations.

#### CAPE – Utilized by DX6VS only

Model	Dimensions			Nominal Capacity Range (tons)	Connection Size		Ship Weight (lbs)
	W"	D"	H"		Liquid"	Suction"	
CAPE4860C4	21	21	30	3½ - 4	¾	¾	71
CAPE4860D4	24½	21	30	3½ - 4	¾	¾	73
CAPE4961C4	21	21	30	4 - 5	¾	¾	78
CAPE4961D4	24½	21	30	4 - 5	¾	¾	80

The manufacturing entity reserves the right to discontinue, or change at any time, specifications or designs without notice or without incurring obligations.

#### CHPE – Utilized by DX6VS only

Model	Cabinet Dimensions			Nominal Capacity Range (tons)	Connection Size		Ship Weight (lbs)
	W"	D"	H"		Liquid"	Suction"	
CHPE2430B4	21⅞	26	17½	1½	¾	¾	56
CHPE3636B4	21⅞	26	17½	2 - 3	¾	¾	59
CHPE3642C4	21⅞	26	21	2 - 3	¾	¾	62
CHPE3743C4	21⅞	26	21	3 - 4	¾	¾	68
CHPE3743D4	21⅞	26	24½	3 - 3½	¾	¾	72
CHPE4860D4	21⅞	26	24½	4 - 5	¾	¾	79

The manufacturing entity reserves the right to discontinue, or change at any time, specifications or designs without notice or without incurring obligations.

# Unitary Split Systems



# DX9VC

## Air Conditioner

Up to 22.5 SEER2

### COMFORTABLE LIMITED WARRANTY\* PROTECTION



\* Complete warranty details available from your local dealer/contractor or at [www.daikincomfort.com](http://www.daikincomfort.com). To receive the 12-Year Unit Replacement Limited Warranty and 12-Year Parts Limited Warranty, online registration must be completed within 60 days of installation. The duration of warranty coverages in Texas differs in some cases.

Additional requirements for annual maintenance are required for the Unit Replacement Limited Warranty. Online registration and some of the additional requirements are not required in California or Québec.

### Standard Features

- » Daikin variable-speed swing and scroll compressors
- » High-density compressor sound blanket
- » Compatible with the Daikin *One+* and Daikin *One* touch smart thermostats and other Daikin communicating equipment
- » Daikin control algorithmic logic
- » In communicating mode, only two low-voltage wires to outdoor unit required
- » Diagnostic indicator lights, seven-segment LED display, and fault code storage
- » Daikin Inside intelligence for diagnostics
- » Field-selectable boost mode increases compressor speed during unusually high loads
- » Quiet DC outdoor fan motor
- » Field-installed bi-flow filter drier
- » Coil and ambient temperature sensors
- » Suction pressure transducer
- » Sweat connection service valves with easy access to gauge ports
- » AHRI Certified; ETL Listed

When properly matched and installed, your communicating DX9VC Air Conditioner offers up to 22.5 SEER2 high-efficiency performance. The higher the SEER, the greater the efficiency — and the lower the operating cost compared to lower SEER2 units. In many applications, the efficiency of your DX9VC can be enhanced by using it in conjunction with a Daikin brand gas furnace that includes a variable-speed blower motor.



This unit features a powder-paint finish over heavy-gauge galvanized steel that provides premium durability and excellent UV protection.



Model	Cooling Capacity (tons)	Voltage-Phase	MCA	MOP	Dimensions			Service Valve		dBs <sup>1,2</sup>	Ship Weight (lbs)	ENERGY STAR® Most Efficient 2023 <sup>1*</sup>
					W"	D"	H"	Liquid"	Suction"			
DX9VCA2410A*	2	208/230-1	15.2	20	35½	35½	38¼	¾	¾	71	241	YES
DX9VCA3610A*	3	208/230-1	20.6	25	35½	35½	38¼	¾	¾	74	253	NO
DX9VCA4810A*	4	208/230-1	30.1	35	35½	35½	41¼	¾	¾	75	353	YES
DX9VCA6010A*	5	208/230-1	31.1	35	35½	35½	41¼	¾	¾	75	353	YES

<sup>1</sup> Maximum sound levels.

<sup>2</sup> Rated in accordance with AHRI standard 270.

The manufacturing entity reserves the right to discontinue, or change at any time, specifications or designs without notice or without incurring obligations.



DAIKIN **ONE+** SMART THERMOSTAT



DAIKIN **ONE TOUCH** SMART THERMOSTAT



Products that are recognized as the Most Efficient of **ENERGY STAR**® in 2023 prevent greenhouse gas emissions by meeting rigorous energy efficiency performance levels set by the U.S. Environmental Protection Agency.

\*Proper sizing and installation of equipment is critical to achieve optimal performance. Split system air conditioners and heat pumps must be matched with appropriate coil components to meet **ENERGY STAR** criteria. Ask your contractor for details or visit [www.energystar.gov](http://www.energystar.gov).



COMFORTABLE LIMITED WARRANTY\* PROTECTION



\* Complete warranty details available from your local dealer/contractor or at [www.daikincomfort.com](http://www.daikincomfort.com). To receive the 12-Year Unit Replacement Limited Warranty and 12-Year Parts Limited Warranty, online registration must be completed within 60 days of installation. The duration of warranty coverages in Texas differs in some cases.

Additional requirements for annual maintenance are required for the Unit Replacement Limited Warranty. Online registration and some of the additional requirements are not required in California or Québec.

**DX7TC**

Air Conditioner

Up to 17.2 SEER2

**Standard Features**

- » Two-Stage Copeland® Ultra-Tech scroll compressor
- » High-density foam compressor sound blanket
- » Compatible with the Daikin *One+* and Daikin *One* touch smart thermostats and other Daikin communicating equipment
- » Copeland® ComfortAlert™ built in diagnostics
- » Copper tube/enhanced aluminum fin coil - 5mm on 2.0-3.0T
- » Diagnostic indicator lights and fault code storage
- » Color-coded terminal strip
- » Quiet ECM outdoor fan motor
- » Fully charged for 15' of tubing length
- » Factory-installed filter drier
- » Ambient temperature sensors
- » High- and low-pressure switches
- » Sweat connection service valves with easy access to gauge ports
- » AHRI Certified; ETL Listed

When properly matched and installed, your DX7TC offers up to 17.2 SEER2 performance. In many applications, the efficiency of your DX7TC can be enhanced by using it in conjunction with a Daikin brand gas furnace that includes a variable-speed blower motor. This unit features a powder-paint finish with premium durability and excellent UV protection. Supports the 2023 DOE Energy Conservation Standards.



Model	Nominal Cooling (Tons)	Voltage-Phase	MCA	MOP	Dimensions			Service Valve		dBs <sup>1</sup>	Ship Weight (lbs)	ENERGY STAR® Certified*	ENERGY STAR® Most Efficient 2023*†
					W"	D"	H"	Liquid"	Suction"				
DX7TCA2410A*	2	208/230-1	15.3	25	35½	35½	39½	¾"	¾"	71	236	YES	YES
DX7TCA3610A*	3	208/230-1	24.1	40	35½	35½	39½	¾"	¾"	72	238	YES	YES
DX7TCA4810A*	4	208/230-1	28.3	45	35½	35½	41½	¾"	¾"	74	298	YES	YES
DX7TCA6010A*	5	208/230-1	32.4	50	35½	35½	41½	¾"	¾"	75	305	YES	NO

\* Note: All the Dimensions (W,D, H) are for reference only

The manufacturing entity reserves the right to discontinue, or change at any time, specifications or designs without notice or without incurring obligations.



DAIKIN **ONE+** SMART THERMOSTAT



DAIKIN **ONE TOUCH** SMART THERMOSTAT



Products that are recognized as the Most Efficient of **ENERGY STAR®** in 2023 prevent greenhouse gas emissions by meeting rigorous energy efficiency performance levels set by the U.S. Environmental Protection Agency.

\*Proper sizing and installation of equipment is critical to achieve optimal performance. Split system air conditioners and heat pumps must be matched with appropriate coil components to meet **ENERGY STAR** criteria. Ask your contractor for details or visit [www.energystar.gov](http://www.energystar.gov).

UNITARY PRODUCTS

# DX6VS

## Air Conditioner

Up to Up to 17.2 SEER2

### COMFORTABLE LIMITED WARRANTY\* PROTECTION



\* Complete warranty details available from your local dealer/contractor or at [www.daikincomfort.com](http://www.daikincomfort.com). To receive the 12-Year Unit Replacement Limited Warranty and 12-Year Parts Limited Warranty, online registration must be completed within 60 days of installation. The duration of warranty coverages in Texas differs in some cases.

Additional requirements for annual maintenance are required for the Unit Replacement Limited Warranty. Online registration and some of the additional requirements are not required in California or Québec.

### Standard Features

- » Daikin variable-speed swing compressors
- » Quiet Daikin engineered digitally commutated fan motor
- » Quiet-mode - provides enhanced acoustical comfort, up to 3 different sound levels (as low as 45dB(A)).
- » High-density foam compressor sound blanket
- » Compatible with the Daikin *One+* and Daikin *One* touch smart thermostats and other Daikin communicating equipment
- » Daikin control algorithmic logic
- » In communicating mode, only two low-voltage wires to outdoor unit required
- » Diagnostic indicator lights, seven-segment LED display, and fault code storage
- » Daikin Inside intelligence for diagnostics
- » Field-selectable boost mode increases compressor speed during unusually high loads
- » Field-installed bi-flow filter drier
- » Coil and ambient temperature sensors
- » Suction pressure transducer
- » Sweat connection service valves with easy access to gauge ports
- » AHRI Certified; ETL Listed

Flexible. Innovative. Technology. The Daikin *Fit* system is a side discharge, smart HVAC system that won't compromise on comfort and connects to ducted solutions traditional to the unitary market. In a market saturated with expensive high-tiered inverters, the system provides a premium mid-efficiency inverter at an affordable rate. The low profile of the outdoor unit offers solutions when a traditional cube style cannot.



DAIKIN **ONE+** SMART THERMOSTAT



DAIKIN **ONE TOUCH** SMART THERMOSTAT



DAIKIN FIT - AC OUTDOOR UNIT											
Model Name	DX6VSS 1810A*	DX6VSS 2410A*	DX6VSS 3010A*	DX6VSS 3610A*	DX6VSS 4210A*	DX6VSS 4810A*	DX6VSS 6010A*	DX6VSA 181WA*	DX6VSA 241WA*	DX6VSA 301WA*	DX6VSA 361WA*
<b>Capacities (AHRI Rated)<sup>1</sup></b>											
Max. Cooling (BTU/h)	16,600	22,200	27,800	33,600	39,500	45,000	53,000	16,600	22,200	27,800	32,400
<b>Ambient Operation Range</b>	0 to 115 (-17.8 to 46.1)										
<b>Cooling (°FDB/°CDB)</b>											
<b>Compressor</b>											
Type	Swing	Swing	Swing	Swing	Swing	Swing	Swing	Swing	Swing	Swing	Swing
RLA	10.0	13.4	16.8	16.8	25.5	25.5	26.9	10.0	13.4	16.8	16.8
<b>Condenser Fan Motor</b>											
Horsepower (HP)	0.09	0.09	0.20	0.20	0.36	0.36	0.36	0.09	0.09	0.20	0.20
FLA	1.15	1.15	2.00	2.00	1.63	1.63	1.63	1.15	1.15	2.00	2.00
<b>Refrigeration System</b>											
Refrigerant Line Size											
Liquid Line Size ("O.D.)	3/8"	3/8"	3/8"	3/8"	3/8"	3/8"	3/8"	3/8"	3/8"	3/8"	3/8"
Suction Line Size ("O.D.)	3/4"	3/4"	7/8"	7/8"	1 1/8"	1 1/8"	1 1/8"	3/4"	3/4"	7/8"	7/8"
Refrigerant Connection Size											
Liquid Valve Size ("O.D.)	3/8"	3/8"	3/8"	3/8"	3/8"	3/8"	3/8"	3/8"	3/8"	3/8"	3/8"
Suction Valve Size ("O.D.)	3/4"	3/4"	7/8"	7/8"	7/8"	7/8"	7/8"	3/4"	3/4"	7/8"	7/8"
Valve Connection Type	Front Sealing	Front Sealing	Front Sealing	Front Sealing	Front and Back Sealing	Front and Back Sealing	Front and Back Sealing	Front Sealing	Front Sealing	Front Sealing	Front Sealing
Refrigerant Charge (oz.)	76	76	79	85	111	111	131	76	76	79	85
Expansion Device	EEV	EEV	EEV	EEV	EEV	EEV	EEV	EEV	EEV	EEV	EEV
Superheat at Service Valve	Auto-Control	Auto-Control	Auto-Control	Auto-Control	Auto-Control	Auto-Control	Auto-Control	Auto-control	Auto-control	Auto-control	Auto-control
Subcooling at Service Valve	10±1°F	12±1°F	14±1°F	15±1°F	8±1°F	9±1°F	9±1°F	10±1°F	12±1°F	14±1°F	13±1°F
<b>Electrical Data</b>											
Voltage / Phase (60 Hz)	208-230/1	208-230/1	208-230/1	208/230-1	208/230-1	208-230/1	208-230/1	208-230/1	208-230/1	208-230/1	208-230/1
Minimum Circuit Ampacity <sup>2</sup>	14.6	18.8	23.9	23.9	34.4	34.4	36.2	14.6	18.8	23.9	23.9
Max. Overcurrent Protection <sup>3</sup>	15	20	25	25	35	35	40	15	20	25	25
Min / Max Volts	197/253	197/253	197/253	197/253	197/253	197/253	197/253	197/253	197/253	197/253	197/253
Electrical Conduit Size	1/2"	1/2"	1/2"	1/2"	1/2 or 3/4"	1/2 or 3/4"	1/2 or 3/4"	1/2"	1/2"	1/2"	1/2"
<b>Equipment Weight (lbs)</b>	119	119	129	133	163	163	174	119	119	129	133
<b>Ship Weight (lbs)</b>	133	133	143	148	183	183	196	133	133	143	148

<sup>1</sup> Testing and rated in accordance with ANSI/AHRI Standard 210/240

<sup>2</sup> Wire size should be determined in accordance with National Electrical Codes; extensive wire runs will require larger wire sizes

<sup>3</sup> Must use time-delay fuses or HACR-type circuit breakers of the same size as noted.

#### Notes

Always check the S&R plate for electrical data on the unit being installed. Unit is charged with refrigerant for 15' of 3/8" liquid line. System charge must be adjusted per Installation Instructions Final Charge Procedure.

COMFORTABLE LIMITED WARRANTY\* PROTECTION



\* Complete warranty details available from your local dealer/contractor or at [www.daikincomfort.com](http://www.daikincomfort.com). To receive the 6-Year Unit Replacement Limited Warranty and 12-Year Parts Limited Warranty, online registration must be completed within 60 days of installation. The duration of warranty coverages in Texas differs in some cases.

Additional requirements for annual maintenance are required for the Unit Replacement Limited Warranty. Online registration and some of the additional requirements are not required in California or Québec.

**DX5SE**

**Air Conditioner**

Up to 15.2 SEER2

**Standard Features**

- » High-efficiency Copeland® scroll compressor
- » Advanced Copeland® CoreSense™ Technology
- » Copper tube/enhanced aluminum fin coil -5mm diameter on 1.5-3.0T
- » High-density foam compressor sound blanket
- » Factory-installed filter drier
- » High- and low-pressure switches
- » Service valves with sweat connections and easy access to gauge ports
- » Fully charged for 15' of tubing length
- » AHRI Certified; ETL Listed

When properly matched and installed, your DX5SE offers up to 15.2 SEER2 performance. In many applications, the efficiency of your DX5SE can be enhanced by using it in conjunction with a Daikin brand gas furnace that includes a variable-speed blower motor. This unit features a powder-paint finish with premium durability and excellent UV protection. Supports the 2023 DOE Energy Conservation Standards.



Model	Cooling Capacity (tons)	Voltage-Phase	MCA	MOP	Dimensions			Service Valve		dBs <sup>1</sup>	Ship Weight (lbs)	ENERGY STAR® Certified*
					W"	D"	H"	Liquid"	Suction"			
DX5SEA1810A*	1½	208/230-1	11.9	20	26	26	27	¾	¾	71	144	YES
DX5SEA2410A*	2	208/230-1	15.3	25	29	29	32	¾	¾	72	169	YES
DX5SEA3010A*	2½	208/230-1	17.0	25	35½	35½	39½	¾	¾	71	224	YES
DX5SEA3610A*	3	208/230-1	18.6	30	35½	35½	39½	¾	¾	74	224	YES
DX5SEA4210A*	3½	208/230-1	23.4	40	35½	35½	36½	¾	¾	71	282	YES
DX5SEA4810A*	4	208/230-1	26.2	45	35½	35½	36½	¾	¾	72	282	YES
DX5SEA6010A*	5	208/230-1	32.4	50	35½	35½	41½	¾	¾"	75	305	YES

\*Note: All the Dimensions (W, D, H) are for reference only

The manufacturing entity reserves the right to discontinue, or change at any time, specifications or designs without notice or without incurring obligations.



**DAIKIN ONE+**  
SMART THERMOSTAT



**DAIKIN ONE TOUCH**  
SMART THERMOSTAT



\* Proper sizing and installation of equipment is critical to achieve optimal performance. Split system air conditioners and heat pumps must be matched with appropriate coil components to meet **ENERGY STAR®** criteria. Ask your contractor for details or visit [www.energystar.gov](http://www.energystar.gov).

UNITARY PRODUCTS

# DX4SE

## Air Conditioner

14.3 SEER2

### COMFORTABLE LIMITED WARRANTY\* PROTECTION



\* Complete warranty details available from your local dealer/contractor or at [www.daikincomfort.com](http://www.daikincomfort.com). To receive the 6-Year Unit Replacement Limited Warranty and 12-Year Parts Limited Warranty, online registration must be completed within 60 days of installation. The duration of warranty coverages in Texas differs in some cases.

Additional requirements for annual maintenance are required for the Unit Replacement Limited Warranty. Online registration and some of the additional requirements are not required in California or Québec.

### Standard Features

- » High-efficiency Copeland® scroll compressor
- » Advanced Copeland® CoreSense™ Technology
- » Copper tube/enhanced aluminum fin coil -5mm diameter on 1.5-3.0T
- » High-density foam compressor sound blanket
- » Factory-installed filter drier
- » High- and low-pressure switches
- » Service valves with sweat connections and easy access to gauge ports
- » Fully charged for 15' of tubing length
- » AHRI Certified; ETL Listed

When properly matched and installed, your DX4SE offers up to 15.2 SEER2 performance. In many applications, the efficiency of your DX4SE can be enhanced by using it in conjunction with a Daikin brand gas furnace that includes a variable-speed blower motor. This unit features a powder-paint finish with premium durability and excellent UV protection. Supports the 2023 DOE Energy Conservation Standards.



Model	Cooling Capacity (tons)	Voltage-Phase	MCA	MOP	Dimensions			Service Valve		dBs	Ship Weight (lbs)
					W"	D"	H"	Liquid"	Suction"		
DX4SEA1810A*	1½	208/230-1	11.9	20	26	26	27	¾"	¾"	71	144
DX4SEA2410A*	2	208/230-1	15.3	25	29	29	32	¾"	¾"	73	169
DX4SEA3010A*	2½	208/230-1	17.0	25	35½	35½	39½	¾"	7⁄8"	72	224
DX4SEA3610A*	3	208/230-1	18.6	30	35½	35½	39½	¾"	7⁄8"	75	224
DX4SEA4210A*	3½	208/230-1	23.4	40	35½	35½	36½	¾"	7⁄8"	72	282
DX4SEA4810A*	4	208/230-1	26.2	45	35½	35½	36½	¾"	7⁄8"	73	282
DX4SEA6010A*	5	208/230-1	32.4	50	35½	35½	41⅝	¾"	7⁄8"	76	305

The manufacturing entity reserves the right to discontinue, or change at any time, specifications or designs without notice or without incurring obligations.



COMFORTABLE LIMITED WARRANTY\* PROTECTION



\* Complete warranty details available from your local dealer/contractor or at [www.daikincomfort.com](http://www.daikincomfort.com). To receive the 12-Year Parts Limited Warranty, online registration must be completed within 60 days of installation. The duration of warranty coverages in Texas differs in some cases.

Additional requirements for annual maintenance are required for the Unit Replacement Limited Warranty. Online registration and some of the additional requirements are not required in California or Québec.

**DX4SQ**

Air Conditioner

14.3 SEER2

**Standard Features**

- » Energy-efficient compressor
- » High-density foam compressor sound blanket on 1.5-2.5T
- » Copper tube/ enhanced aluminum fin coil- 5mm diameter on 1.5-4.0T
- » Single-Speed PSC condenser fan motor
- » Factory-installed filter drier
- » Sweat connection service valves with easy access to gauge ports
- » Contactor with lug connection
- » AHRI Certified; ETL Listed

When properly matched and installed, your DX4SQ offers up to 15.2 SEER2 performance. In many applications, the efficiency of your DX4SQ can be enhance by using it in conjunction with a Daikin brand gas furnace that includes a variable-speed blower motor. This unit features a powder-paint with premium durability and excellent UV protection. Supports the 2023 DOE Energy Conservation Standards.



Model	Cooling Capacity (tons)	Voltage-Phase	MCA	MOP	Dimensions			Service Valve		dBs	Ship Weight (lbs)
					W"	D"	H"	Liquid"	Suction"		
DX4SQA1810A*	1½	208/230-1	8.3	15	26	26	27	¾"	¾"	71	136
DX4SQA2410A*	2	208/230-1	11.2	15	26	26	32½"	¾"	¾"	72	153
DX4SQA3010A*	2½	208/230-1	15.5	25	29	29	39½"	¾"	¾"	72	180
DX4SQA3610A*	3	208/230-1	21.0	35	35½"	35½"	35¾"	¾"	¾"	72	180
DX4SQA4210A*	3½	208/230-1	23.1	40	35½"	35½"	39½"	¾"	¾"	71	207
DX4SQA4810A*	4	208/230-1	26.2	45	35½"	35½"	39½"	¾"	¾"	73	242
DX4SQA6010A*	5	208/230-1	33.3	50	35½"	35½"	36½"	¾"	¾"	75	280

The manufacturing entity reserves the right to discontinue, or change at any time, specifications or designs without notice or without incurring obligations.

UNITARY PRODUCTS

# DX3SE

## Air Conditioner

13.4 SEER2

### COMFORTABLE LIMITED WARRANTY\* PROTECTION



\* Complete warranty details available from your local dealer/contractor or at [www.daikincomfort.com](http://www.daikincomfort.com). To receive the 6-Year Unit Replacement Limited Warranty and 12-Year Parts Limited Warranty, online registration must be completed within 60 days of installation. The duration of warranty coverages in Texas differs in some cases.

Additional requirements for annual maintenance are required for the Unit Replacement Limited Warranty. Online registration and some of the additional requirements are not required in California or Québec.

### Standard Features

- » High-efficiency Copeland® scroll compressor
- » Advanced Copeland® CoreSense™ Technology
- » Copper tube/enhanced aluminum fin coil -5mm diameter
- » High-density foam compressor sound blanket
- » Factory-installed filter drier
- » High- and low-pressure switches
- » Service valves with sweat connections and easy access to gauge ports
- » Fully charged for 15' of tubing length
- » AHRI Certified; ETL Listed

When properly matched and installed, your DX3SE Air Conditioner offers up to 14.5 SEER2 energy-efficient performance. The higher the SEER2, the greater the efficiency — and the lower the operating cost compared to lower SEER2 units. In many applications, the efficiency of your DX3SE can be enhanced by using it in conjunction with a Daikin brand gas furnace.



This unit features a powder-paint finish over heavy-gauge galvanized steel that provides premium durability and excellent UV protection.



Model	Cooling Capacity (tons)	Voltage-Phase	MCA	MOP	Dimensions			Service Valve		dBs	Ship Weight (lbs)
					W"	D"	H"	Liquid"	Suction"		
DX3SEN1810A*	1½	208/230-1	12.0	20	26	26	27	¾"	¾"	68	135
DX3SEN2410A*	2	208/230-1	15.1	25	26	26	32½	¾"	¾"	68	149
DX3SEN3010A*	2½	208/230-1	17.0	25	29	29	32½	¾"	¾"	72	166
DX3SEN3610A*	3	208/230-1	18.6	30	29	29	32½	¾"	¾"	70	168
DX3SEN4210A*	3½	208/230-1	23.1	40	29	29	39½	¾"	¾"	69	203
DX3SEN4810A*	4	208/230-1	24.4	40	35½	35½	35¾	¾"	¾"	73	235
DX3SEN6010A*	5	208/230-1	33.3	50	35½	35½	39½	¾"	¾"	73	247

Daikin Comfort Technologies Manufacturing, L.P., reserves the right to discontinue or change at any time specifications or designs without notice or without incurring obligations.

\* Note: All the Dimensions (W,D, H) are for reference only

COMFORTABLE LIMITED WARRANTY\* PROTECTION



\* Complete warranty details available from your local dealer/contractor or at [www.daikincomfort.com](http://www.daikincomfort.com). To receive 12-Year Parts Limited Warranty, online registration must be completed within 60 days of installation. Online registration not required in California or Québec. The duration of warranty coverages in Texas differs in some cases.

**DX3SQ**

Air Conditioner

13.4 SEER2

**Standard Features**

- » Energy-efficient compressor
- » Copper tube/ enhanced aluminum fin coil- 5mm diameter
- » Single-Speed PSC condenser fan motor
- » Factory-installed filter drier
- » Sweat connection service valves with easy access to gauge ports
- » Contactor with lug connection
- » AHRI Certified; ETL Listed

When properly matched and installed, your DX3SQ Air Conditioner offers up to 14.5 SEER2 energy-efficient performance. In many applications, the efficiency of your DX3SQ can be enhanced by using it in conjunction with a Daikin brand gas furnace.



This unit features a powder-paint finish over heavy-gauge galvanized steel that provides premium durability and excellent UV protection.



Model	Cooling Capacity (tons)	Voltage-Phase	MCA	MOP	Dimensions			Service Valve		dBs	Ship Weight (lbs)
					W"	D"	H"	Liquid"	Suction"		
DX3SQN1810A*	1½	208/230-1	8.3	15	26	26	27	¾"	¾"	73	130
DX3SQN2410A*	2	208/230-1	11.2	15	26	26	32½	¾"	¾"	73	138
DX3SQN3010A*	2½	208/230-1	16.1	25	29	29	32½	¾"	¾"	76	143
DX3SQN3610A*	3	208/230-1	18.6	30	29	29	32½	¾"	¾"	71	168
DX3SQN4210A*	3½	208/230-1	23.1	40	29	29	39½	¾"	7/8"	70	203
DX3SQN4810A*	4	208/230-1	24.4	40	35½	35½	35¾	¾"	7/8"	74	235
DX3SQN6010A*	5	208/230-1	33.3	50	35½	35½	39½	¾"	7/8"	74	247

Daikin Comfort Technologies Manufacturing, L.P., reserves the right to discontinue or change at any time specifications or designs without notice or without incurring obligations.

\* Note: All the Dimensions (W,D, H) are for reference only

UNITARY PRODUCTS

# DZ9VC

## Heat Pump

Up to 22.5 SEER2 | Up to 8.2 HSPF

### COMFORTABLE LIMITED WARRANTY\* PROTECTION



\* Complete warranty details available from your local dealer/contractor or at [www.daikincomfort.com](http://www.daikincomfort.com). To receive the 12-Year Unit Replacement Limited Warranty and 12-Year Parts Limited Warranty, online registration must be completed within 60 days of installation. The duration of warranty coverages in Texas differs in some cases.

Additional requirements for annual maintenance are required for the Unit Replacement Limited Warranty. Online registration and some of the additional requirements are not required in California or Québec.

### Standard Features

- » Daikin variable-speed swing compressors
- » High-density compressor sound blanket
- » Compatible with the Daikin *One+* and Daikin *One* touch smart thermostats and other Daikin communicating equipment
- » Daikin control algorithmic logic
- » In communicating mode, only two low-voltage wires to outdoor unit required
- » Diagnostic indicator lights, seven-segment LED display, and fault code storage
- » Daikin Inside intelligence for diagnostics
- » Field-selectable boost mode increases compressor speed during unusually high loads
- » Quiet DC outdoor fan motor
- » Fully charged for 15' of tubing length
- » Field-installed bi-flow filter drier
- » Coil and ambient temperature sensors
- » Suction pressure transducer (in cooling mode)
- » Sweat connection service valves with easy access to gauge ports
- » AHRI Certified; ETL Listed

When properly matched and installed, your communicating DZ9VC Variable-Speed Heat Pump offers up to 22.5 SEER2 high-efficiency performance. The higher the SEER2, the greater the efficiency — and the lower the operating cost compared to lower SEER units.



In many applications, the efficiency of your DZ9VC can be enhanced by using it in conjunction with a Daikin brand gas furnace or air handler that includes a variable-speed blower motor.

This unit features a powder-paint finish over heavy-gauge galvanized steel that provides premium durability and excellent UV protection.



Model	Nominal Capacities (tons)	Voltage-Phase	MCA	MOP	Dimensions			Service Valve		dBs <sup>1,2</sup>	Ship Weight (lbs)	ENERGY STAR® Most Efficient 2023 <sup>†</sup>
					W "	D "	H "	Liquid "	Suction "			
DZ9VCA2410A*	2	208-230/1	15.2	20	35½	35½	38¼	¾"	¾"	68	243	YES
DZ9VCA3610A*	3	208-230/1	29.8	30	35½	35½	41¼	¾"	¾"	70	318	YES
DZ9VCA4810A*	4	208-230/1	29.8	30	35½	35½	41¼	¾"	¾"	75	318	YES
DZ9VCA6010A*	5	208-230/1	30.6	35	35½	35½	41¼	¾"	¾"	75	318	NO

<sup>1</sup> Maximum Sound levels

<sup>2</sup> Rated in accordance with AHRI standard 270.

Daikin Manufacturing Company, L.P., reserves the right to discontinue, or change at any time, specifications or designs without notice or without incurring obligations.



DAIKIN *ONE+* SMART THERMOSTAT



DAIKIN *ONE TOUCH* SMART THERMOSTAT



Products that are recognized as the Most Efficient of ENERGY STAR® in 2023 prevent greenhouse gas emissions by meeting rigorous energy efficiency performance levels set by the U.S. Environmental Protection Agency.

\*Proper sizing and installation of equipment is critical to achieve optimal performance. Split system air conditioners and heat pumps must be matched with appropriate coil components to meet ENERGY STAR criteria. Ask your contractor for details or visit [www.energystar.gov](http://www.energystar.gov).



## COMFORTABLE LIMITED WARRANTY\* PROTECTION



\* Complete warranty details available from your local dealer/contractor or at [www.daikincomfort.com](http://www.daikincomfort.com). To receive the 12-Year Unit Replacement Limited Warranty and 12-Year Parts Limited Warranty, online registration must be completed within 60 days of installation. The duration of warranty coverages in Texas differs in some cases.

Additional requirements for annual maintenance are required for the Unit Replacement Limited Warranty. Online registration and some of the additional requirements are not required in California or Québec.

### Standard Features

- » Two-Stage Copeland® UltraTech scroll compressor
- » High-density foam compressor sound blanket
- » Compatible with the Daikin *One+* and Daikin *One* touch smart thermostats and other Daikin communicating equipment
- » ComfortAlert™ built in diagnostics
- » Copper tube/enhanced aluminum fin coil - 5mm on 2.0-3.0T
- » Efficient, two-speed ECM condenser fan motor
- » Simple low-voltage wiring to outdoor unit in communicating mode
- » Diagnostic indicator lights and storage of six fault codes
- » Color-coded terminal strip for non-communicating set-up
- » High- and low-pressure switches
- » Time-delay technology with short-cycle protection to ensure quiet, reliable defrost
- » Factory-installed bi-flow liquid-line filter drier
- » Factory-installed suction-line accumulator
- » Factory-installed compressor crankcase heater
- » Factory-installed high-capacity muffler
- » Factory-installed coil and ambient temperature sensors
- » AHRI Certified; ETL Listed

When properly matched and installed, your communicating DZ7TC Variable-Speed Heat Pump offers up to 17.2 SEER high-efficiency performance. The higher the SEER, the greater the efficiency — and the lower the operating cost compared to lower SEER units. In many applications, the efficiency of your DZ7TC can be enhanced by using it in conjunction with a Daikin brand air handler that includes a variable-speed blower motor.



This unit features a powder-paint finish over heavy-gauge galvanized steel that provides premium durability and excellent UV protection.



Model	Nominal Capacities (tons)		Voltage-Phase	MCA	MOP	Dimensions			Service Valve		dBs <sup>1</sup>	Ship Weight (lbs)	ENERGY STAR® 2023
	Cooling <sup>1</sup>	Heating <sup>1</sup>				W "	D "	H "	Liquid "	Suction "			
DZ7TCA2410A*	2	2	208/230-1	16.4	25	35½	35½	39½	¾"	¾"	71	239	Most Efficient <sup>†</sup>
DZ7TCA3610A*	3	3	208/230-1	24.1	40	35½	35½	35¾	¾"	¾"	75	277	Most Efficient <sup>†</sup>
DZ7TCA4810A*	4	4	208/230-1	27.7	45	35½	35½	41½	¾"	1½"	77	327	Most Efficient <sup>†</sup>
DZ7TCA6010A*	5	5	208/230-1	32.4	50	35½	35½	41½	¾"	1½"	78	335	ENERGY STAR <sup>†</sup>

<sup>1</sup> Maximum Sound levels

Daikin Manufacturing Company, L.P., reserves the right to discontinue, or change at any time, specifications or designs without notice or without incurring obligations.



DAIKIN ONE+ SMART THERMOSTAT



DAIKIN ONE TOUCH SMART THERMOSTAT



Products that are recognized as the Most Efficient of ENERGY STAR® in 2023 prevent greenhouse gas emissions by meeting rigorous energy efficiency performance levels set by the U.S. Environmental Protection Agency.

\* Proper sizing and installation of equipment is critical to achieve optimal performance. Split system air conditioners and heat pumps must be matched with appropriate coil components to meet ENERGY STAR criteria. Ask your contractor for details or visit [www.energystar.gov](http://www.energystar.gov).



<sup>†</sup> Proper sizing and installation of equipment is critical to achieving optimal performance. Split system air conditioners and heat pumps must be matched with appropriate coil components to meet ENERGY STAR® criteria. Ask your contractor for details or visit [www.energystar.gov](http://www.energystar.gov). The [www.energystar.gov](http://www.energystar.gov) website provides up-to-date system combinations certified to meet ENERGY STAR® requirements.

UNITARY PRODUCTS

# DZ6VS

## Heat Pump

Up to 17.5 SEER2 & 8.5 HSPF2

### COMFORTABLE LIMITED WARRANTY\* PROTECTION



\* Complete warranty details available from your local dealer/contractor or at [www.daikincomfort.com](http://www.daikincomfort.com). To receive the 12-Year Unit Replacement Limited Warranty and 12-Year Parts Limited Warranty, online registration must be completed within 60 days of installation. The duration of warranty coverages in Texas differs in some cases.

Additional requirements for annual maintenance are required for the Unit Replacement Limited Warranty. Online registration and some of the additional requirements are not required in California or Québec.

### Standard Features

- » Daikin variable-speed swing compressors
- » Quiet Daikin engineered digitally commutated fan motor
- » High-density foam compressor sound blanket
- » Compatible with the Daikin *One+* and Daikin *One* touch smart thermostats and other Daikin communicating equipment Daikin control algorithmic logic
- » Intelligent Defrost Mode
- » In communicating mode, only two low-voltage wires to outdoor unit required
- » Diagnostic indicator lights, seven-segment LED display, and fault code storage
- » Daikin Inside intelligence for diagnostics
- » Field-selectable boost mode increases compressor speed during unusually high loads
- » Field-installed bi-flow filter drier
- » Coil and ambient temperature sensors
- » Suction pressure transducer
- » Muffler on 1.5-3.0-ton models
- » Quiet-mode - provides enhanced acoustical comfort, up to 3 different sound levels (as low as 45dBA).
- » Sweat connection service valves with easy access to gauge ports

Flexible. Innovative. Technology. The Daikin *Fit* system is a side discharge, smart HVAC system that won't compromise on comfort and connects to ducted solutions traditional to the unitary market. In a market saturated with expensive high-tiered inverters, the system provides a premium mid-efficiency inverter at an affordable rate. The low profile of the outdoor unit offers solutions when a traditional cube style cannot.



DAIKIN *ONE+*  
SMART THERMOSTAT



DAIKIN *ONE TOUCH*  
SMART THERMOSTAT



- » Advanced water-shedding drain pan
- » Hot start technology
- » AHRI Certified; ETL Listed

DAIKIN <i>FIT</i> - HEAT PUMP OUTDOOR UNIT							
Model Name	DZ6VSA 1810A*	DZ6VSA 2410A*	DZ6VSA 3010A*	DZ6VSA 3610A*	DZ6VSA 4210A*	DZ6VSA 4810A*	DZ6VSA 6010A*
<b>Capacities (AHRI Rated)<sup>1</sup></b>							
Max. Cooling (BTU/h)	16,600	22,200	27,800	33,600	39,500	45,000	53,000
Max. Heating (BTU/h)	17,400	23,200	28,800	34,600	40,000	45,500	54,500
<b>Ambient Operation Range</b>	0 to 115 (-17.8 to 46.1)						
Cooling (°F DB/(°C DB))	-10 to 70 (-23.3 to 21.1)						
Heating (°F DB/(°C DB))							
<b>Compressor</b>							
Type	Swing Compressor	Swing Compressor	Swing Compressor	Swing Compressor	Swing Compressor	Swing Compressor	Swing Compressor
RLA	10.0	13.4	16.8	16.8	25.5	25.5	26.9
<b>Condenser Fan Motor</b>							
Horsepower (HP)	0.09	0.09	0.20	0.20	0.36	0.36	0.36
FLA	1.15	1.15	2.00	2.00	1.63	1.63	1.63
<b>Refrigeration System</b>							
Refrigerant Line Size							
Liquid Line Size ("O.D.)	3/8"	3/8"	3/8"	3/8"	3/8"	3/8"	3/8"
Suction Line Size ("O.D.)	3/4"	3/4"	7/8"	7/8"	1 1/8"	1 1/8"	1 1/8"
Refrigerant Connection Size							
Liquid Valve Size ("O.D.)	3/8"	3/8"	3/8"	3/8"	3/8"	3/8"	3/8"
Suction Valve Size ("O.D.)	3/4"	3/4"	7/8"	7/8"	7/8"	7/8"	7/8"
Valve Connection Type	Front Sealing	Front Sealing	Front Sealing	Front Sealing	Front and Back Sealing	Front and Back Sealing	Front and Back Sealing
Refrigerant Charge (oz.)	81	81	88	88	118	118	127
Expansion Device	EEV	EEV	EEV	EEV	EEV	EEV	EEV
Superheat at Service Valve	Auto-control	Auto-control	Auto-control	Auto-control	Auto-control	Auto-control	Auto-control
Subcooling at Service Valve	10±1°F	12±1°F	14±1°F	15±1°F	8±1°F	9±1°F	9±1°F
<b>Electrical Data</b>							
Voltage / Phase (60 Hz)	208-230/1	208-230/1	208-230/1	208-230/1	208-230/1	208-230/1	208-230/1
Minimum Circuit Ampacity <sup>2</sup>	14.6	18.8	23.9	23.9	34.4	34.4	36.2
Max. Overcurrent Protection <sup>3</sup>	15	20	25	25	35	35	40
Min / Max Volts	197/253	197/253	197/253	197/253	197/253	197/253	197/253
Electrical Conduit Size	1/2"	1/2"	1/2"	1/2"	1/2" or 3/4"	1/2" or 3/4"	1/2" or 3/4"
<b>Equipment Weight (lbs)</b>	122	122	132	137	168	168	179
<b>Ship Weight (lbs)</b>	137	137	147	151	185	185	198

<sup>1</sup> Tested and rated in accordance with AHRI Standard 210/240.

<sup>2</sup> Wire size should be determined in accordance with National Electrical Codes; extensive wire runs will require larger wire sizes.

<sup>3</sup> Must use time-delay fuses or HACR-type circuit breakers of the same size as noted.

**Notes:**

Always check the S&R plate for electrical data on the unit being installed.

/ System charge must be adjusted per Installation Instructions Final Charge Procedure.

## COMFORTABLE LIMITED WARRANTY\* PROTECTION



\* Complete warranty details available from your local dealer/contractor or at [www.daikincomfort.com](http://www.daikincomfort.com). To receive the 6-Year Unit Replacement Limited Warranty and 12-Year Parts Limited Warranty, online registration must be completed within 60 days of installation. The duration of warranty coverages in Texas differs in some cases.

Additional requirements for annual maintenance are required for the Unit Replacement Limited Warranty. Online registration and some of the additional requirements are not required in California or Québec.

## DZ5SE

# Heat Pump

Up to 15.2 SEER2 | 7.8 HSPF2

### Standard Features

- » High-efficiency Copeland® scroll compressor
- » Advanced Copeland® CoreSense™ technology
- » Copper tube/enhanced aluminum fin coil - 5mm diameter on 1.5-3.5T
- » High density foam compressor sound blanket
- » Time-delay technology to ensure quiet reliable defrost
- » Factory-installed bi-flow liquid line filter drier
- » Factory-installed suction line accumulator
- » Factory-installed compressor crank case heater
- » Factory-installed high capacity muffler
- » High- and low-pressure switches
- » Service valves with sweat connections and easy access to gauge ports
- » Copper tube/enhanced aluminum fin coil
- » Fully charged for 15' of tubing length
- » AHRI Certified; ETL Listed

When properly matched and installed, your DZ5SE offers up to 15.2 SEER2 performance. In many applications, the efficiency of your DZ5SE can be enhanced by using it in conjunction with a Daikin brand gas furnace or air handler that includes a variable-speed blower motor. This unit features a powder-paint finish with premium durability and excellent UV protection. Supports the 2023 DOE Energy Conservation Standards.



Model	Nominal Cooling (Tons)	Voltage Phase	MCA	MOP	Dimensions			Service Valve		dBs	Ship Weight (lbs)	ENERGY STAR® Certified*
					W"	D"	H"	Liquid	Suction			
DZ5SEA1810A*	1½	208/230-1	12.2	20	26	26	27	¾"	¾"	68	186	YES
DZ5SEA2410A*	2	208/230-1	15.3	25	29	29	32	¾"	¾"	72	213	YES
DZ5SEA3010A*	2½	208/230-1	18.6	30	35½	35½	39½	¾"	7/8"	69	235	YES
DZ5SEA3610A*	3	208/230-1	22.8	35	35½	35½	39½	¾"	7/8"	72	242	YES
DZ5SEA4210A*	3½	208/230-1	23.4	40	35½	35½	36½	¾"	7/8"	75	284	YES
DZ5SEA4810A*	4	208/230-1	26	45	35½	35½	36½	¾"	7/8"	73	292	YES
DZ5SEA6010A*	5	208/230-1	33.0	50	35½	35½	41½	¾"	7/8"	75	329	YES

The manufacturing entity reserves the right to discontinue, or change at any time, specifications or designs without notice or without incurring obligations.

\*Note: All the Dimensions (W, D, H) are for reference only



DAIKIN ONE+ SMART THERMOSTAT



DAIKIN ONE TOUCH SMART THERMOSTAT



\* Proper sizing and installation of equipment is critical to achieve optimal performance. Split system air conditioners and heat pumps must be matched with appropriate coil components to meet ENERGY STAR® criteria. Ask your contractor for details or visit [www.energystar.gov](http://www.energystar.gov).

UNITARY PRODUCTS

# DZ4SE

## Heat Pump

14.3 SEER2 | 7.5 HSPF2

### COMFORTABLE LIMITED WARRANTY\* PROTECTION



\* Complete warranty details available from your local dealer/contractor or at [www.daikincomfort.com](http://www.daikincomfort.com). To receive the 6-Year Unit Replacement Limited Warranty and 12-Year Parts Limited Warranty, online registration must be completed within 60 days of installation. The duration of warranty coverages in Texas differs in some cases.

Additional requirements for annual maintenance are required for the Unit Replacement Limited Warranty. Online registration and some of the additional requirements are not required in California or Québec.

### Standard Features

- » High-efficiency Copeland® scroll compressor
- » Advanced Copeland® CoreSense™ technology
- » Copper tube/enhanced aluminum fin coil - 5mm diameter on 1.5-3.5T
- » High density foam compressor sound blanket
- » Time-delay technology to ensure quiet reliable defrost
- » Factory-installed bi-flow liquid line filter drier
- » Factory-installed suction line accumulator
- » Factory-installed compressor crank case heater
- » Factory-installed high capacity muffler
- » High- and low-pressure switches
- » Service valves with sweat connections and easy access to gauge ports
- » Fully charged for 15' of tubing length
- » AHRI Certified; ETL Listed

When properly matched and installed, your DZ4SE Heat Pump offers up to 14.3 SEER2 high-efficiency performance. The higher the SEER, the greater the efficiency — and the lower the operating cost compared to lower SEER2 units. In many applications, the efficiency of your DZ4SE can be enhanced by using it in conjunction with a Daikin brand gas furnace or air handler.



This unit features a powder-paint finish over heavy-gauge galvanized steel that provides premium durability and excellent UV protection.



Model	Nominal Capacities (tons)		Voltage-Phase	MCA	MOP	Dimensions			Service Valve		dBs	Ship Weight (lbs)
	Cooling <sup>1</sup>	Heating <sup>1</sup>				W"	D"	H"	Liquid"	Suction"		
DZ4SEA1810A*	1½	1½	208/230-1	12.2	20	29	29	35 <sup>11</sup> / <sub>16</sub>	¾"	¾"	68	179
DZ4SEA2410A*	2	2	208/230-1	15.3	25	29	29	35 <sup>11</sup> / <sub>16</sub>	¾"	¾"	72	179
DZ4SEA3010A*	2½	2½	208/230-1	18.6	30	29	29	39 <sup>9</sup> / <sub>16</sub>	¾"	¾"	75	190
DZ4SEA3610A*	3	3	208/230-1	21	35	35½	35½	39 <sup>10</sup> / <sub>16</sub>	¾"	¾"	72	234
DZ4SEA4210A*	3½	3½	208/230-1	23.4	40	35½	35½	35 <sup>13</sup> / <sub>16</sub>	¾"	¾"	75	284
DZ4SEA4810A*	4	4	208/230-1	26.2	45	35½	35½	36 <sup>7</sup> / <sub>16</sub>	¾"	¾"	74	292
DZ4SEA6010A*	5	5	208/230-1	33.3	50	35½	35½	41 <sup>10</sup> / <sub>16</sub>	¾"	¾"	75	325

<sup>1</sup> Tons of Refrigeration

The manufacturing entity reserves the right to discontinue, or change at any time, specifications or designs without notice or without incurring obligations.



COMFORTABLE LIMITED WARRANTY\* PROTECTION



\* Complete warranty details available from your local dealer/contractor or at [www.daikincomfort.com](http://www.daikincomfort.com). To receive 2-Year Unit Replacement Limited Warranty and the 12-Year Parts Limited Warranty, online registration must be completed within 60 days of installation. Online registration not required in California or Québec. The duration of warranty coverages in Texas differs in some cases.

**DZ4SQ**

Heat Pump

14.3 SEER2 | 7.5 HSPF2

**Standard Features**

- » Energy-efficient compressor
- » Refrigeration-grade premium copper tubing and aluminum fin condenser coil
- » Time-delay defrost technology
- » Factory-installed in-line filter drier
- » Factory-installed heater band and accumulator
- » Quiet condenser fan motor
- » Heavy-gauge galvanized steel cabinet with sound-control top
- » Baked enamel finish protects the system from the elements
- » AHRI certified; ETL listed

When properly matched and installed, your DZ4SQ Heat Pump offers up to 14.3 SEER2 high-efficiency performance. The higher the SEER2, the greater the efficiency — and the lower the operating cost compared to lower SEER2 units. In many applications, the efficiency of your DZ4SQ can be enhanced by using it in conjunction with a Daikin brand gas furnace or air handler.



This unit features a powder-paint finish over heavy-gauge galvanized steel that provides premium durability and excellent UV protection.



Model	Nominal Capacities		Voltage-Phase	MCA	MOP	Dimensions			Service Valve		dBs	Ship Weight (lbs)
	Cooling <sup>1</sup>	Heating <sup>1</sup>				W "	D "	H "	Liquid "	Suction "		
DZ4SQA1810A*	1½	1½	208/230-1	8.6	15	29	29	35 <sup>11</sup> / <sub>16</sub>	¾"	¾"	70	176
DZ4SQA2410A*	2	2	208/230-1	11.5	15	29	29	35 <sup>11</sup> / <sub>16</sub>	¾"	¾"	74	175
DZ4SQA3010A*	2½	2½	208/230-1	18.6	30	29	29	39 <sup>9</sup> / <sub>16</sub>	¾"	¾"	75	190
DZ4SQA3610A*	3	3	208/230-1	21	35	35½	35½	39 <sup>10</sup> / <sub>16</sub>	¾"	7⁄8"	72	234
DZ4SQA4210A*	3½	3½	208/230-1	23.4	40	35½	35½	35 <sup>13</sup> / <sub>16</sub>	¾"	7⁄8"	75	284
DZ4SQA4810A*	4	4	208/230-1	26.2	45	35½	35½	36 <sup>7</sup> / <sub>16</sub>	¾"	7⁄8"	74	292
DZ4SQA6010A*	5	5	208/230-1	33.3	50	35½	35½	41 <sup>10</sup> / <sub>16</sub>	¾"	7⁄8"	75	325

<sup>1</sup> Tons of Refrigeration

The manufacturing entity reserves the right to discontinue, or change at any time, specifications or designs without notice or without incurring obligations.







# Unitary Gas Furnaces

# DM97MC

## Gas Furnace

Up to 97% AFUE

### COMFORTABLE LIMITED WARRANTY\* PROTECTION



\* Complete warranty details available from your local dealer/contractor or at [www.daikincomfort.com](http://www.daikincomfort.com). To receive the Lifetime Heat Exchanger Limited Warranty (good for as long as you own your home), 12-Year Unit Replacement Limited Warranty and 12-Year Parts Limited Warranty, online registration must be completed within 60 days of installation. The duration of warranty coverages in Texas differs in some cases.

Additional requirements for annual maintenance are required for the Unit Replacement Limited Warranty. Online registration and some of the additional requirements are not required in California or Québec.

### Standard Features

- » Multi-position installation: upflow, horizontal left or right
- » Compatible with Daikin *One+* and Daikin *One* touch smart thermostats and other Daikin communicating equipment
- » Heavy-duty tubular stainless-steel heat exchanger
- » Secondary stainless-steel heat exchanger for increased efficiency
- » Quiet variable-speed induced draft blower motor
- » Durable silicon nitride igniter
- » Self-diagnostic control board with constant memory fault code history output to a dual 7-segment display
- » Self-calibrating modulating gas valve auto configures for each installation
- » Fully insulated heat exchanger and blower section
- » Optional continuous air circulation to keep the air moving throughout the home
- » Color-coded low-voltage terminals with provisions for electronic air cleaner and humidifier
- » Efficient and quiet variable-speed ECM indoor blower motor
- » Cabinet air leakage ( $Q_{Leak} \leq 2\%$ )
- » Can not be installed in California's South Coast Air Quality Management District (SCAQMD) and San Joaquin Valley Air Pollution Control District (SJVAPCD).

With the Daikin brand DM97MC Modulating, Variable-Speed communicating systems furnace, you will own what we believe to be our best furnace. Not only will this furnace provide your family with years of reliable warmth in even the harshest winters, it will do so economically.

In tandem with its variable-speed blower motor, this modulating gas furnace typically runs at the lowest possible speed to precisely maintain a constant, steady temperature, which will deliver optimal heating performance to your home.



Model	High-Fire Rate <sup>1</sup>		Low-Fire Rate <sup>1</sup>		AFUE (%)	Tons A/C <sup>2</sup>	MCA	MOP	Dimensions			Ship Weight (lbs)	ENERGY STAR® Certified
	Input	Output	Input	Output					W"	D"	H"		
DM97MC0603BNA*	60,000	58,800	30,000	29,400	98	3	8.8	15	17½	28¾	34½	118	YES
DM97MC0803BNA*	80,000	77,600	40,000	38,800	97	3	8.8	15	17½	28¾	34½	121	YES
DM97MC0804CNA*	80,000	78,400	40,000	39,200	98	4	11.6	15	21	28¾	34½	142	YES
DM97MC1005CNA*	100,000	97,000	50,000	48,500	97	5	15.4	20	21	28¾	34½	144	YES
DM97MC1205DNA*	120,000	116,400	60,000	58,200	97	5	15.4	20	24½	28¾	34½	157	YES

<sup>1</sup> BTU/h <sup>2</sup> @ 0.5" ESP

The manufacturing entity reserves the right to discontinue, or change at any time, specifications or designs without notice or without incurring obligations.



DAIKIN *ONE+*  
SMART THERMOSTAT



DAIKIN *ONE TOUCH*  
SMART THERMOSTAT





## COMFORTABLE LIMITED WARRANTY\* PROTECTION



\* Complete warranty details available from your local dealer/contractor or at [www.daikincomfort.com](http://www.daikincomfort.com). To receive the Lifetime Heat Exchanger Limited Warranty (good for as long as you own your home), 12-Year Unit Replacement Limited Warranty and 12-Year Parts Limited Warranty, online registration must be completed within 60 days of installation. The duration of warranty coverages in Texas differs in some cases.

Additional requirements for annual maintenance are required for the Unit Replacement Limited Warranty. Online registration and some of the additional requirements are not required in California or Québec.

## DC97MC

## Gas Furnace

Up to 97% AFUE

### Standard Features

- » Multi-position installation: downflow, horizontal left or right
- » Compatible with the Daikin *One+* and Daikin *One* touch smart thermostats and other Daikin communicating equipment
- » Heavy-duty tubular stainless-steel heat exchanger
- » Secondary stainless-steel heat exchanger for increased efficiency
- » Quiet variable-speed induced draft blower motor
- » Durable silicon nitride igniter
- » Self-diagnostic control board with constant memory fault code history output to a dual 7-segment display
- » Self-calibrating modulating gas valve auto configures for each installation
- » Fully insulated heat exchanger and blower section
- » Optional continuous air circulation to keep the air moving throughout the home
- » Color-coded low-voltage terminals with provisions for electronic air cleaner and humidifier
- » Efficient and quiet variable-speed ECM indoor blower motor
- » Cabinet air leakage ( $Q_{Leak} \leq 2\%$ )
- » Can not be installed in California's South Coast Air Quality Management District (SCAQMD) and San Joaquin Valley Air Pollution Control District (SJVAPCD).

With the Daikin brand DC97MC Modulating, Variable-Speed communicating systems furnace, you will own what we believe to be our best furnace. Not only will this furnace provide your family with years of reliable warmth in even the harshest winters, it will do so economically.

In tandem with its variable-speed blower motor, this modulating gas furnace typically runs at the lowest possible speed to precisely maintain a constant, steady temperature, which will deliver optimal heating performance to your home.



Model	High-Fire Rate <sup>1</sup>		Low-Fire Rate <sup>1</sup>		AFUE (%)	Tons A/C <sup>2</sup>	MCA	MOP	Dimensions			Ship Weight (lbs)	ENERGY STAR® Certified
	Input	Output	Input	Output					W"	D"	H"		
DC97MC0603BNA*	60,000	58,200	30,000	29,100	97	3	8.8	15	17½	28¾	34½	117	YES
DC97MC0803BNA*	80,000	77,600	40,000	38,800	97	3	8.8	15	17½	28¾	34½	122	YES
DC97MC0804CNA*	80,000	77,600	40,000	38,800	97	4	11.6	15	21	28¾	34½	144	YES
DC97MC1005CNA*	100,000	97,000	50,000	48,500	97	5	15.4	20	21	28¾	34½	146	YES

<sup>1</sup> BTU/h <sup>2</sup> @ 0.5" ESP

The manufacturing entity reserves the right to discontinue, or change at any time, specifications or designs without notice or without incurring obligations.



DAIKIN *ONE+*  
SMART THERMOSTAT



DAIKIN *ONE TOUCH*  
SMART THERMOSTAT



# DM96VC

## Gas Furnace

Up to 96% AFUE

### COMFORTABLE LIMITED WARRANTY\* PROTECTION



\* Complete warranty details available from your local dealer/contractor or at [www.daikincomfort.com](http://www.daikincomfort.com). To receive the Lifetime Heat Exchanger Limited Warranty (good for as long as you own your home), 12-Year Unit Replacement Limited Warranty and 12-Year Parts Limited Warranty, online registration must be completed within 60 days of installation. The duration of warranty coverages in Texas differs in some cases.

Additional requirements for annual maintenance are required for the Unit Replacement Limited Warranty. Online registration and some of the additional requirements are not required in California or Québec.

### Standard Features

- » Multi-position installation: upflow, horizontal left or right
- » Compatible with the Daikin *One+* and Daikin *One* touch smart thermostats and other Daikin communicating equipment
- » Heavy-duty tubular stainless-steel heat exchanger
- » Secondary stainless-steel heat exchanger for increased efficiency
- » Quiet variable-speed ECM indoor blower motor
- » Quiet two-speed induced draft blower
- » Durable silicon nitride igniter
- » Self-diagnostic control board with constant memory fault code history output to a dual 7-segment display
- » Two-stage gas valve
- » Fully insulated heat exchanger and blower section
- » Optional continuous air circulation to keep the air moving throughout the home
- » Color-coded low-voltage terminals with provisions for electronic air cleaner and humidifier
- » Cabinet air leakage ( $Q_{Leak} \leq 2\%$ )
- » Can not be installed in California's South Coast Air Quality Management District (SCAQMD) and San Joaquin Valley Air Pollution Control District (SJVAPCD).
- » All models comply with CA Low NOx standards

The Daikin brand DM96VC Variable-Speed communicating systems furnace provides exceptional indoor comfort and quiet operation. This furnace features a stainless-steel tubular heat exchanger and durable silicon nitride ignition system.

With its two-stage gas valve and variable-speed airflow system, the DM96VC provide homeowners with comfort all season long.



Model	High-Fire Rate <sup>1</sup>		Low-Fire Rate <sup>1</sup>		AFUE (%)	Tons A/C <sup>2</sup>	MCA	MOP	Dimensions			Ship Weight (lbs)	ENERGY STAR® Certified
	Input	Output	Input	Output					W"	D"	H"		
DM96VC0403BNA*	40,000	38,400	28,000	26,880	96	3	7.8	15	17½	28¾	34½	114	YES
DM96VC0603BNA*	60,000	57,600	42,000	40,320	96	3	7.8	15	17½	28¾	34½	117	YES
DM96VC0803BNA*	80,000	76,800	56,000	53,760	96	3	7.8	15	17½	28¾	34½	120	YES
DM96VC0804CNA*	80,000	76,800	56,000	53,760	96	4	10.6	15	21	28¾	34½	141	YES
DM96VC1005CNA*	100,000	96,000	70,000	67,200	96	5	14.4	20	21	28¾	34½	143	YES
DM96VC1005DNA*	100,000	96,000	70,000	67,200	96	5	14.4	20	24½	28¾	34½	153	YES
DM96VC1205DNA*	120,000	115,200	84,000	80,640	96	5	14.4	20	24½	28¾	34½	156	YES

<sup>1</sup> BTU/h <sup>2</sup> @ 0.5" ESP

The manufacturing entity reserves the right to discontinue, or change at any time, specifications or designs without notice or without incurring obligations.



DAIKIN *ONE+* SMART THERMOSTAT



DAIKIN *ONE* TOUCH SMART THERMOSTAT



## COMFORTABLE LIMITED WARRANTY\* PROTECTION



\* Complete warranty details available from your local dealer/contractor or at [www.daikincomfort.com](http://www.daikincomfort.com). To receive the Lifetime Heat Exchanger Limited Warranty (good for as long as you own your home), 12-Year Unit Replacement Limited Warranty and 12-Year Parts Limited Warranty, online registration must be completed within 60 days of installation. The duration of warranty coverages in Texas differs in some cases.

Additional requirements for annual maintenance are required for the Unit Replacement Limited Warranty. Online registration and some of the additional requirements are not required in California or Québec.

## DC96VC

## Gas Furnace

Up to 96% AFUE

### Standard Features

- » Multi-position installation: downflow, horizontal left or right
- » Compatible with the Daikin *One+* and Daikin *One* touch smart thermostats and other Daikin communicating equipment
- » Heavy-duty tubular stainless-steel heat exchanger
- » Secondary stainless-steel heat exchanger for increased efficiency
- » Quiet variable-speed ECM indoor blower motor
- » Quiet two-speed induced draft blower
- » Durable silicon nitride igniter
- » Self-diagnostic control board with constant memory fault code history output to a dual 7-segment display
- » Two-stage gas valve
- » Fully insulated heat exchanger and blower section
- » Continuous air circulation to keep the air moving throughout the home
- » Color-coded low-voltage terminals with provisions for electronic air cleaner and humidifier
- » Cabinet air leakage ( $Q_{Leak}$ )  $\leq 2\%$
- » Can not be installed in California's South Coast Air Quality Management District (SCAQMD) and San Joaquin Valley Air Pollution Control District (SJVAPCD).
- » All models comply with CA Low NOx standards

The Daikin brand DC96VC Variable-Speed communicating systems furnace provides exceptional indoor comfort and quiet operation. This furnace features a stainless-steel tubular heat exchanger and durable silicon nitride ignition system.

With its two-stage gas valve and variable-speed airflow system, the DC96VC provide homeowners with comfort all season long.



Model	High-Fire Rate <sup>1</sup>		Low-Fire Rate <sup>1</sup>		AFUE (%)	Tons A/C <sup>2</sup>	MCA	MOP	Dimensions			Ship Weight (lbs)	ENERGY STAR® Certified
	Input	Output	Input	Output					W"	D"	H"		
DC96VC0403BNA*	40,000	38,400	28,000	26,880	96	3	7.8	15	17½	28¾	34½	116	YES
DC96VC0603BNA*	60,000	57,600	42,000	40,320	96	3	7.8	15	17½	28¾	34½	119	YES
DC96VC0804CNA*	80,000	76,800	56,000	53,760	96	4	10.6	15	21	28¾	34½	143	YES
DC96VC1005CNA*	100,000	96,000	70,000	67,200	96	5	14.4	20	21	28¾	34½	145	YES
DC96VC1205DNA*	120,000	115,200	84,000	80,640	96	5	14.4	20	24½	28¾	34½	158	YES

<sup>1</sup> BTU/h<sup>2</sup> @ 0.5" ESP

The manufacturing entity reserves the right to discontinue, or change at any time, specifications or designs without notice or without incurring obligations.



DAIKIN *ONE+*  
SMART THERMOSTAT



DAIKIN *ONE TOUCH*  
SMART THERMOSTAT



UNITARY PRODUCTS

# DM96SC-U

## Gas Furnace

Up to 96% AFUE

### COMFORTABLE LIMITED WARRANTY\* PROTECTION



\* Complete warranty details available from your local dealer/contractor or at [www.daikincomfort.com](http://www.daikincomfort.com). To receive the Lifetime Heat Exchanger Limited Warranty (good for as long as you own your home), 12-Year Unit Replacement Limited Warranty and 12-Year Parts Limited Warranty, online registration must be completed within 60 days of installation. The duration of warranty coverages in Texas differs in some cases.

Additional requirements for annual maintenance are required for the Unit Replacement Limited Warranty. Online registration and some of the additional requirements are not required in California or Québec.

#### Standard Features

- » Multi-position installation: upflow, horizontal left or right
- » Compatible with the Daikin *One+* and Daikin *One* touch smart thermostats and other Daikin communicating equipment
- » Heavy-duty stainless-steel tubular heat exchanger
- » Single-stage gas valve
- » Super-ferritic Stainless-steel secondary heat exchanger
- » Durable Silicon Nitride igniter
- » Quiet variable-speed ECM indoor blower motor
- » Quiet modulating draft inducer
- » Self-diagnostic control board with constant memory fault code history output to three 7-segment display with push buttons
- » Color-coded low-voltage input terminal for dehumidification control, and line voltage terminal provided for electronic air cleaner connection
- » Cabinet air leakage ( $Q_{Leak}$ )  $\leq 1.4\%$
- » Foil-faced insulated heat exchanger cabinet
- » All Ultra-Low NO<sub>x</sub> DM96SC-U models comply with the 14 ng/J emission limit specified in the South Coast Air Quality Management District (SCAQMD) Rule 1111 and San Joaquin Valley Air Pollution Control District (SJVAPCD) Rule 4905. Learn more at [www.aqmd.gov](http://www.aqmd.gov) and [www.valleyair.org](http://www.valleyair.org).

The Daikin brand DM96SC-U Variable-Speed blower motor, Multi-Position Ultra Low-NO<sub>x</sub> Gas Furnace features our heavy-duty stainless-steel tubular heat exchanger and durable silicon nitride hot-surface ignition system.

This furnace is run-tested for heating or combination heating/cooling applications. Not only will this furnace provide your family with years of reliable warmth in even the harshest winters, it will do so economically. This quiet furnace delivers a money-saving efficiency of up to 96% AFUE compared to lower AFUE furnaces.



Model	High-Fire Rate <sup>1</sup>		AFUE (%)	Tons A/C <sup>2</sup>	MCA	MOP	Dimensions			Ship Weight (lbs)
	Input	Output					W"	D"	H"	
DM96SC0603BU*	60,000	57,600	96	3	8.8	15.4	17½	28¾	34½	122
DM96SC0805BU*	80,000	76,800	96	5	15	20	21	28¾	34½	147

<sup>1</sup> BTU/h <sup>2</sup> @ 0.5" ESP

The manufacturing entity reserves the right to discontinue, or change at any time, specifications or designs without notice or without incurring obligations.



DAIKIN *ONE+*  
SMART THERMOSTAT



DAIKIN *ONE TOUCH*  
SMART THERMOSTAT



## COMFORTABLE LIMITED WARRANTY\* PROTECTION



\* Complete warranty details available from your local dealer/contractor or at [www.daikincomfort.com](http://www.daikincomfort.com). To receive the Lifetime Heat Exchanger Limited Warranty (good for as long as you own your home), 6-Year Unit Replacement Limited Warranty and 12-Year Parts Limited Warranty, online registration must be completed within 60 days of installation. The duration of warranty coverages in Texas differs in some cases.

Additional requirements for annual maintenance are required for the Unit Replacement Limited Warranty. Online registration and some of the additional requirements are not required in California or Québec.

## DM96TN

## Gas Furnace

Up to 96% AFUE

### Standard Features

- » Multi-position installation: upflow, horizontal left or right
- » Heavy-duty tubular stainless-steel heat exchanger
- » Secondary stainless-steel heat exchanger for increased efficiency
- » Energy-efficient multi-speed (9-speed tap) ECM blower motor
- » Quiet two-speed induced draft blower
- » Durable silicon nitride igniter
- » Self-diagnostic control board with constant memory fault code history output to a 3-digit 7 segment LED display and push buttons
- » Two-stage gas valve
- » Fully insulated heat exchanger and blower section
- » Optional continuous air circulation to keep the air moving throughout the home
- » Color-coded low-voltage terminals with provisions for electronic air cleaner and humidifier
- » Cabinet air leakage ( $Q_{Leak}$ )  $\leq 2\%$
- » Can not be installed in California's South Coast Air Quality Management District (SCAQMD) and San Joaquin Valley Air Pollution Control District (SJVAPCD)
- » All models comply with CA Low NOx standards

The Daikin brand DM96TN 9-Speed ECM, Two-Stage gas valve, Multi-Position Gas Furnace features our heavy-duty stainless-steel tubular heat exchanger and durable silicon nitride hot-surface ignition system. This furnace is run-tested for heating or combination heating/cooling applications.

Not only will this furnace provide your family with years of reliable warmth in even the harshest winters, it will do so economically. This quiet furnace delivers a money-saving efficiency of up to 96% AFUE compared to lower AFUE furnaces.



Model	High-Fire Rate <sup>1</sup>		Low-Fire Rate <sup>1</sup>		AFUE (%)	Tons A/C <sup>2</sup>	MCA	MOP	Dimensions			Ship Weight (lbs)	ENERGY STAR® Certified
	Input	Output	Input	Output					W"	D"	H"		
DM96TN0303ANA*	30,000	28,800	21,000	20,160	96	2	8.6	15	14	28¾	34½	106	YES
DM96TN0403ANA*	40,000	38,400	28,000	26,880	96	2	8.6	15	14	28¾	34½	106	YES
DM96TN0603ANA*	60,000	57,600	42,000	40,320	96	3	8.6	15	14	28¾	34½	110	YES
DM96TN0603BNA*	60,000	57,600	42,000	40,320	96	3	8	15	17½	28¾	34½	115	YES
DM96TN0803BNA*	80,000	76,800	56,000	53,760	96	3	8	15	17½	28¾	34½	118	YES
DM96TN0804CNA*	80,000	76,800	56,000	53,760	96	4	11.6	15	21"	28¾	34½	123	YES
DM96TN1004CNA*	100,000	96,000	70,000	67,200	96	4	13.3	15	21"	28¾	34½	140	YES
DM96TN1005CNA*	100,000	96,000	70,000	67,200	96	5	13.3	15	21"	28¾	34½	140	YES
DM96TN1205DNA*	120,000	115,200	84,000	80,640	96	5	13.3	15	24½	28¾	34½	154	YES

<sup>1</sup> BTU/h <sup>2</sup> @ 0.5" ESP

The manufacturing entity reserves the right to discontinue, or change at any time, specifications or designs without notice or without incurring obligations.



# DC96TN

## Gas Furnace

Up to 96% AFUE

### COMFORTABLE LIMITED WARRANTY\* PROTECTION



\* Complete warranty details available from your local dealer/contractor or at [www.daikincomfort.com](http://www.daikincomfort.com). To receive the Lifetime Heat Exchanger Limited Warranty (good for as long as you own your home), 6-Year Unit Replacement Limited Warranty and 12-Year Parts Limited Warranty, online registration must be completed within 60 days of installation. The duration of warranty coverages in Texas differs in some cases.

Additional requirements for annual maintenance are required for the Unit Replacement Limited Warranty. Online registration and some of the additional requirements are not required in California or Québec.

### Standard Features

- » Multi-position installation: downflow, horizontal left and right
- » Heavy-duty tubular stainless-steel heat exchanger
- » Secondary stainless-steel heat exchanger for increased efficiency
- » Energy-efficient multi-speed (9-speed tap) ECM blower motor
- » Quiet single-speed induced draft blower
- » Durable silicon nitride igniter
- » Self-diagnostic control board with constant memory fault code history output to a 3-digit 7 segment LED display and push buttons
- » Two-stage gas valve
- » Fully insulated heat exchanger and blower section
- » Optional continuous air circulation to keep the air moving throughout the home
- » Color-coded low-voltage terminals with provisions for electronic air cleaner and humidifier
- » Cabinet air leakage ( $Q_{Leak} \leq 2\%$ )
- » Can not be installed in California's South Coast Air Quality Management District (SCAQMD) and San Joaquin Valley Air Pollution Control District (SJVAPCD).
- » All models comply with CA Low NOx standards

The Daikin brand DC96TN 9-Speed ECM, Two-Stage gas valve, Multi-Position Gas Furnace features our heavy-duty stainless-steel tubular heat exchanger and durable silicon nitride hot-surface ignition system. This furnace is run-tested for heating or combination heating/cooling applications.



Not only will this furnace provide your family with years of reliable warmth in even the harshest winters, it will do so economically. This quiet furnace delivers a money-saving efficiency of up to 96% AFUE compared to lower AFUE furnaces.

Model	High-Fire Rate <sup>1</sup>		Low-Fire Rate <sup>1</sup>		AFUE (%)	Tons A/C <sup>2</sup>	MCA	MOP	Dimensions			Ship Weight (lbs)	ENERGY STAR® Certified
	Input	Output	Input	Output					W"	D"	H"		
DC96TN0403BNA*	40,000	38,400	28,000	26,880	96	2	8	15	17½	28¾	34½	112	YES
DC96TN0603BNA*	60,000	57,600	42,000	40,320	96	3	8	15	17½	28¾	34½	115	YES
DC96TN0803BNA*	80,000	76,800	56,000	53,760	96	4	8	15	17½	28¾	34½	118	YES
DC96TN1005CNA*	100,000	96,000	70,000	67,200	96	5	13.3	15	21	28¾	34½	140	YES

<sup>1</sup> BTU/h <sup>2</sup> @ 0.5" ESP

The manufacturing entity reserves the right to discontinue, or change at any time, specifications or designs without notice or without incurring obligations.



COMFORTABLE LIMITED WARRANTY\* PROTECTION



\* Complete warranty details available from your local dealer/contractor or at [www.daikincomfort.com](http://www.daikincomfort.com). To receive the Lifetime Heat Exchanger Limited Warranty (good for as long as you own your home), 6-Year Unit Replacement Limited Warranty and 12-Year Parts Limited Warranty, online registration must be completed within 60 days of installation. The duration of warranty coverages in Texas differs in some cases.

Additional requirements for annual maintenance are required for the Unit Replacement Limited Warranty. Online registration and some of the additional requirements are not required in California or Québec.

DM96SN / DM96SN-U

Gas Furnace  
Up to 96% AFUE

Standard Features

DM96SN / DM96SN-U

- » Multi-position installation: upflow, horizontal left or right
- » Heavy-duty stainless-steel tubular heat exchanger
- » Stainless-steel secondary heat exchanger (All Ultra-Low NOx models have Super-ferretic stainless-steel secondary heat exchanger).
- » Energy-efficient multi-speed (9-speed tap) ECM blower motor
- » Quiet single-speed induced draft blower
- » Durable Silicon Nitride igniter
- » Self-diagnostic control board with constant memory fault code history output to a 3-digit 7 segment LED display and push buttons
- » Single-stage gas valve
- » Fully insulated heat exchanger and blower section
- » Optional continuous air circulation to keep the air moving throughout the home
- » Self-diagnostic control board continuously monitors the system for consistent, reliable operation
- » AHRI Certified; ETL Listed
- » All models comply with CA Low NOx standards

DM96SN

- Can not be installed in California's South Coast Air Quality Management District (SCAQMD) and San Joaquin Valley Air Pollution Control District (SJVAPCD).

The Daikin brand DM96SN / DM96SN-U 9-Speed ECM, Single-Stage gas valve, Multi-Position Gas Furnace features our heavy-duty stainless-steel tubular heat exchanger and durable silicon nitride hot-surface ignition system. This furnace is run-tested for heating or combination heating/cooling applications.



Not only will this furnace provide your family with years of reliable warmth in even the harshest winters, it will do so economically. This quiet furnace delivers a money-saving efficiency of up to 96% AFUE compared to lower AFUE furnaces.

DM96SN-U

- All Ultra-Low NOx DM96SN-U models comply with the 14 ng/J emission limit specified in the South Coast Air Quality Management District (SCAQMD) Rule 1111 and San Joaquin Valley Air Pollution Control District (SJVAPCD) Rule 4905. Learn more at [www.aqmd.gov](http://www.aqmd.gov) and [www.valleyair.org](http://www.valleyair.org).



DM96SN

Model	High-Fire Rate (BTU/h) <sup>1</sup>		AFUE (%)	Tons A/C <sup>2</sup>	MCA	MOP	Dimensions			Ship Weight (lbs)	ENERGY STAR <sup>®</sup> Certified
	Input	Output					W"	D"	H"		
DM96SN0403ANA*	40,000	38,400	96	2	10.3	15	17½	28¾	34½	113	YES
DM96SN0603BNA*	60,000	57,600	96	3	10.3	15	17½	28¾	34½	116	YES
DM96SN0803BNA*	80,000	76,800	96	3	10.3	15	17½	28¾	34½	118	YES
DM96SN0804CNA*	80,000	76,800	96	4	14.1	15	21	28¾	34½	141	YES
DM96SN0805CNA*	80,000	76,800	96	5	16.93	20	21	28¾	34½	142	YES
DM96SN1005CNA*	100,000	96,000	96	5	16.93	20	21	28¾	34½	144	YES
DM96SN1205DNA*	120,000	115,320	96	5	16.93	20	24½	28¾	34½	156	YES

DM96SN-U

Model	High-Fire Rate (BTU/h) <sup>1</sup>		AFUE (%)	Tons A/C <sup>2</sup>	MCA	MOP	Dimensions			Ship Weight (lbs)	ENERGY STAR <sup>®</sup> Certified
	Input	Output					W"	D"	H"		
DM96SN0403BUA*	40,000	38,400	96	2	10.8	15	17½	28¾	34½	115	YES
DM96SN0603BUA*	60,000	57,600	96	3	10.8	15	17½	28¾	34½	120	YES
DM96SN0805CUA*	80,000	76,800	96	3	16.1	20	21	28¾	34½	145	YES

<sup>1</sup> BTU/h <sup>2</sup> @ 0.5" ESP

The manufacturing entity reserves the right to discontinue, or change at any time, specifications or designs without notice or without incurring obligations.

UNITARY PRODUCTS

# DC96SN

## Gas Furnace

Up to 96% AFUE

### COMFORTABLE LIMITED WARRANTY\* PROTECTION



\* Complete warranty details available from your local dealer/contractor or at [www.daikincomfort.com](http://www.daikincomfort.com). To receive the Lifetime Heat Exchanger Limited Warranty (good for as long as you own your home), 6-Year Unit Replacement Limited Warranty and 12-Year Parts Limited Warranty, online registration must be completed within 60 days of installation. The duration of warranty coverages in Texas differs in some cases.

Additional requirements for annual maintenance are required for the Unit Replacement Limited Warranty. Online registration and some of the additional requirements are not required in California or Québec.

### Standard Features

- » Multi-position installation: downflow, horizontal left and right
- » Heavy-duty tubular stainless-steel heat exchanger
- » Secondary stainless-steel heat exchanger for increased efficiency
- » Energy-efficient multi-speed (9-speed tap) ECM blower motor
- » Quiet single-speed induced draft blower
- » Durable silicon nitride igniter
- » Self-diagnostic control board with constant memory fault code history output to a 3-digit 7 segment LED display and push buttons
- » Single stage gas valve
- » Fully insulated heat exchanger and blower section
- » Optional continuous air circulation to keep the air moving throughout the home
- » All models comply with CA Low NOx standards
- » Can not be installed in California's South Coast Air Quality Management District (SCAQMD) and San Joaquin Valley Air Pollution Control District (SJVAPCD).

The Daikin brand DC96SN 9-Speed ECM, Single-Stage gas valve, Multi-Position Gas Furnace features our heavy-duty stainless-steel tubular heat exchanger and durable silicon nitride hot-surface ignition system. This furnace is run-tested for heating or combination heating/cooling applications.



Not only will this furnace provide your family with years of reliable warmth in even the harshest winters, it will do so economically. This quiet furnace delivers a money-saving efficiency of up to 96% AFUE compared to lower AFUE furnaces.

Model	High-Fire Rate (BTU/h) <sup>1</sup>		AFUE (%)	Tons A/C <sup>2</sup>	MCA	MOP	Dimensions			Ship Weight (lbs)	ENERGY STAR® Certified
	Input	Output					W"	D"	H"		
DC96SN0403BNA*	40,000	38,440	96	2	9.6	15	17½	28¾	34½	111	YES
DC96SN0603BNA*	60,000	57,660	96	3	9.6	15	17½	28¾	34½	114	YES
DC96SN0804CNA*	80,000	76,880	96	4	11.7	14.1	21	28¾	34½	139	YES
DC96SN1005CNA*	100,000	95,000	95	5	16.93	20	21	28¾	34½	142	YES
DC96SN1205DNA*	120,000	114,000	95	5	16.93	20	24½	28¾	34½	154	YES

<sup>1</sup> BTU/h <sup>2</sup> @ 0.5" ESP

The manufacturing entity reserves the right to discontinue, or change at any time, specifications or designs without notice or without incurring obligations.





## COMFORTABLE LIMITED WARRANTY\* PROTECTION



\* Complete warranty details available from your local dealer/contractor or at [www.daikincomfort.com](http://www.daikincomfort.com). To receive the Lifetime Heat Exchanger Limited Warranty (good for as long as you own your home), 6-Year Unit Replacement Limited Warranty and 12-Year Parts Limited Warranty, online registration must be completed within 60 days of installation. The duration of warranty coverages in Texas differs in some cases.

Additional requirements for annual maintenance are required for the Unit Replacement Limited Warranty. Online registration and some of the additional requirements are not required in California or Québec.

## DM92SN

## Gas Furnace

Up to 92% AFUE

### Standard Features

- » Multi-position installation: upflow, horizontal left or right
- » Heavy-duty stainless-steel tubular heat exchanger
- » Stainless-steel secondary heat exchanger
- » Single-stage gas valve
- » Durable Silicon Nitride igniter
- » Energy-efficient multi-speed (9-speed tap) ECM blower motor
- » Quiet single-speed induced draft blower
- » Fully insulated heat exchanger and blower section
- » Self-diagnostic control board with constant memory fault code history output to a 3-digit 7 segment LED display and push buttons
- » AHRI Certified; ETL Listed
- » Can not be installed in California's South Coast Air Quality Management District (SCAQMD) and San Joaquin Valley Air Pollution Control District (SJVAPCD).
- » All models comply with CA Low NOx standards).

The Daikin brand DM92SN 9-Speed ECM, Single-Stage gas valve, Multi-Position Gas Furnace features our heavy-duty stainless-steel tubular heat exchanger and durable silicon nitride hot-surface ignition system. This furnace is run-tested for heating or combination heating/cooling applications.

Not only will this furnace provide your family with years of reliable warmth in even the harshest winters, it will do so economically. This quiet furnace delivers a money-saving efficiency of up to 92% AFUE compared to lower AFUE furnaces.



Model	High Fire Rate (BTU/h)		AFUE (%)	Tons A/C <sup>1</sup>	MCA	MOP	Dimensions			Ship Weight (lbs)
	Input	Output					W"	D"	H"	
DM92SN0403ANA*	40,000	36,800	92	3	10.3	15	17½	28¾	34½	111
DM92SN0603BNA*	60,000	55,200	92	3	10.3	15	17½	28¾	34½	114
DM92SN0803BNA*	80,000	73,600	92	3	10.3	15	17½	28¾	34½	117
DM92SN0804CNA*	80,000	73,600	92	4	14.1	15	21	28¾	34½	139
DM92SN0805CNA*	80,000	73,600	92	5	16.93	20	21	28¾	34½	141
DM92SN1004CNA*	100,000	92,000	92	4	14.1	15	21	28¾	34½	141
DM92SN1005CNA*	100,000	92,000	92	5	16.93	20	21	28¾	34½	142
DM92SN1205DNA*	120,000	110,400	92	5	16.93	20	24½	28¾	34½	154

<sup>1</sup> @ 0.5" ESP

The manufacturing entity reserves the right to discontinue, or change at any time, specifications or designs without notice or without incurring obligations.

# DM80VC

## Gas Furnace

Up to 80% AFUE

### COMFORTABLE LIMITED WARRANTY\* PROTECTION



\* Complete warranty details available from your local dealer/contractor or at [www.daikincomfort.com](http://www.daikincomfort.com). To receive the Lifetime Heat Exchanger Limited Warranty (good for as long as you own your home), 6-Year Unit Replacement Limited Warranty and 12-Year Parts Limited Warranty, online registration must be completed within 60 days of installation. The duration of warranty coverages in Texas differs in some cases.

Additional requirements for annual maintenance are required for the Unit Replacement Limited Warranty. Online registration and some of the additional requirements are not required in California or Québec.

### Standard Features

- » Multi-position installation: upflow, horizontal left or right
- » Compatible with the Daikin *One+* and Daikin *One* touch smart thermostats and other Daikin communicating equipment
- » Heavy-duty tubular stainless-steel heat exchanger
- » Quiet, variable-speed ECM indoor blower motor
- » Quiet, two-speed induced draft blower
- » Durable silicon nitride igniter
- » Self-diagnostic control board with constant memory fault code history output to a dual 7-segment display
- » Heavy-gauge steel cabinet with durable baked-enamel finish
- » Two-stage gas valve
- » Fully insulated heat exchanger and blower section
- » Continuous air circulation to keep the air moving throughout the home
- » Color-coded low-voltage terminals with provisions for electronic air cleaner and humidifier
- » Cabinet air leakage ( $Q_{Leak}$ )  $\leq 2\%$
- » California Low NO<sub>x</sub> emissions models available
- » Can not be installed in California's South Coast Air Quality Management District (SCAQMD) and San Joaquin Valley Air Pollution Control District (SJVAPCD).

The Daikin brand DM80VC Two-Stage, Variable-Speed Gas Furnace provides exceptional indoor comfort and quiet operation. This furnace features a stainless-steel tubular heat exchanger and durable silicon nitride ignition system. With its two-stage gas valves and variable-speed circulator blower, the DM80VC provides comfort all season long.



Model	High-Fire Rate <sup>1</sup>		Low-Fire Rate <sup>1</sup>		AFUE (%)	Tons A/C <sup>2</sup>	MCA	MOP	Dimensions			Ship Weight (lbs)
	Input	Output	Input	Output					W"	D"	H"	
DM80VC0603B*A*	60,000	48,000	42,000	33,600	80	1½-3	7.75	15	17½	28	33¾	105
DM80VC0604B*A*	60,000	48,000	42,000	33,600	80	1½-4	10.6	15	17½	28	33¾	107
DM80VC0803B*A*	80,000	64,000	56,000	44,800	80	1½-3	7.75	15	17½	28	33¾	110
DM80VC0804C*A*	80,000	64,000	56,000	44,800	80	3-4	7.75	15	21	28	33¾	118
DM80VC0805C*A*	80,000	64,000	56,000	44,800	80	2-5	10.6	15	21	28	33¾	121
DM80VC0805D*A*	80,000	64,000	56,000	44,800	80	2-5	10.6	15	24½	28	33¾	129
DM80VC1005C*A*	100,000	80,000	70,000	56,000	80	2-5	10.6	15	21	28	33¾	124

<sup>1</sup> BTU/h <sup>2</sup> @ 0.5" ESP

The manufacturing entity reserves the right to discontinue, or change at any time, specifications or designs without notice or without incurring obligations.



DAIKIN *ONE+*  
SMART THERMOSTAT



DAIKIN *ONE TOUCH*  
SMART THERMOSTAT

## COMFORTABLE LIMITED WARRANTY\* PROTECTION



\* Complete warranty details available from your local dealer/contractor or at [www.daikincomfort.com](http://www.daikincomfort.com). To receive the Lifetime Heat Exchanger Limited Warranty (good for as long as you own your home), 6-Year Unit Replacement Limited Warranty and 12-Year Parts Limited Warranty, online registration must be completed within 60 days of installation. The duration of warranty coverages in Texas differs in some cases.

Additional requirements for annual maintenance are required for the Unit Replacement Limited Warranty. Online registration and some of the additional requirements are not required in California or Québec.

## DC80VC

## Gas Furnace

Up to 80% AFUE

### Standard Features

- » Multi-position installation: down flow, horizontal left or right
- » Compatible with the Daikin *One+* and Daikin *One* touch smart thermostats and other Daikin communicating equipment
- » Heavy-duty tubular stainless-steel heat exchanger
- » Quiet variable-speed ECM indoor motor
- » Quiet, two-speed induced draft blower
- » Durable silicon nitride igniter
- » Self-diagnostic control board with constant memory fault code history output to a dual 7-segment display
- » Heavy-gauge steel cabinet with durable baked-enamel finish
- » Two-stage gas valve
- » Fully insulated heat exchanger and blower section
- » Optional continuous air circulation to keep the air moving throughout the home
- » Color-coded low-voltage terminals with provisions for electronic air cleaner and humidifier
- » Cabinet air leakage ( $Q_{Leak}$ )  $\leq 2\%$
- » All models comply with CA Low NOx standards
- » Can not be installed in California's South Coast Air Quality Management District (SCAQMD) and San Joaquin Valley Air Pollution Control District (SJVAPCD).

The Daikin brand DC80VC Two-Stage, Variable-Speed Gas Furnace provides exceptional indoor comfort and quiet operation. This furnace features a stainless-steel tubular heat exchanger and durable silicon nitride ignition system. With its two-stage gas valves and variable-speed circulator blowers, the DC80VC provides comfort all season long.



Model	High-Fire Rate <sup>1</sup>		Low-Fire Rate <sup>1</sup>		AFUE (%)	Tons A/C <sup>2</sup>	MCA	MOP	Dimensions			Ship Weight (lbs)
	Input	Output	Input	Output					W"	D"	H"	
DC80VC0603BXA*	60,000	48,000	42,000	33,600	80	1½-3	7.75	15	17½	28	33¾	105
DC80VC0803BXA*	80,000	64,000	56,000	44,800	80	2-5	7.75	15	17½	28	33¾	109
DC80VC0805CXA*	80,000	64,000	56,000	44,800	80	2-5	10.6	15	21	28	33¾	125
DC80VC1005CXA*	100,000	80,000	70,000	56,000	80	2-5	10.6	15	21	28	33¾	129

<sup>1</sup> BTU/h <sup>2</sup> @ 0.5" ESP

The manufacturing entity reserves the right to discontinue, or change at any time, specifications or designs without notice or without incurring obligations.



**DAIKIN ONE+**  
SMART THERMOSTAT



**DAIKIN ONE TOUCH**  
SMART THERMOSTAT

# DM80SC-U

## Gas Furnace

Up to 80% AFUE

### COMFORTABLE LIMITED WARRANTY\* PROTECTION



\* Complete warranty details available from your local dealer/contractor or at [www.daikincomfort.com](http://www.daikincomfort.com). To receive the Lifetime Heat Exchanger Limited Warranty (good for as long as you own your home), 6-Year Unit Replacement Limited Warranty and 12-Year Parts Limited Warranty, online registration must be completed within 60 days of installation. The duration of warranty coverages in Texas differs in some cases.

Additional requirements for annual maintenance are required for the Unit Replacement Limited Warranty. Online registration and some of the additional requirements are not required in California or Québec.

#### Standard Features

- » Multi-position installation: upflow, horizontal left or right
- » Compatible with the Daikin *One+* and Daikin *One* touch smart thermostats and other Daikin communicating equipment
- » Heavy-duty stainless-steel tubular heat exchanger
- » Single-stage gas valve
- » Stainless-steel secondary heat exchanger
- » Durable Silicon Nitride igniter
- » Quiet variable-speed ECM indoor blower motor
- » Quiet modulating draft inducer
- » Self-diagnostic control board with constant memory fault code history output to three 7-segment display with push buttons
- » Color-coded low-voltage input terminal for dehumidification control, and line voltage terminal provided for electronic air cleaner connection
- » Cabinet air leakage ( $Q_{Leak}$ )  $\leq 2\%$
- » Foil faced insulated heat exchanger
- » All Ultra-Low NO<sub>x</sub> DM80SC-U models comply with the 14 ng/J emission limit specified in the South Coast Air Quality Management District (SCAQMD) Rule 1111 and San Joaquin Valley Air Pollution Control District (SJVAPCD) Rule 4905. Learn more at [www.aqmd.gov](http://www.aqmd.gov) and [www.valleyair.org](http://www.valleyair.org).

The Daikin brand DM80SN-U Multi-Speed, Multi-Position Ultra Low-NO<sub>x</sub> Gas Furnace features our heavy-duty stainless-steel tubular heat exchanger and durable silicon nitride hot-surface ignition system. This furnace is run-tested for heating or combination heating/cooling applications. Not only will this furnace provide your family with years of reliable warmth in even the harshest winters, it will do so economically. This quiet furnace delivers a money-saving efficiency of up to 80% AFUE compared to lower AFUE furnaces.



Model	High-Fire Rate <sup>1</sup>		AFUE (%)	Tons A/C <sup>2</sup>	MCA	MOP	Dimensions			Ship Weight (lbs)
	Input	Output					W"	D"	H"	
DM80SC0604BU*	60,000	48,000	80	1½-3	11.6	15	17½	28	33¾	112
DM80SC0805BU*	80,000	64,000	80	1½-4	11.6	15	21	28	33¾	127

<sup>1</sup> BTU/h <sup>2</sup> @ 0.5" ESP

The manufacturing entity reserves the right to discontinue, or change at any time, specifications or designs without notice or without incurring obligations.



DAIKIN *ONE+*  
SMART THERMOSTAT



DAIKIN *ONE TOUCH*  
SMART THERMOSTAT



## COMFORTABLE LIMITED WARRANTY\* PROTECTION



\* Complete warranty details available from your local dealer/contractor or at [www.daikincomfort.com](http://www.daikincomfort.com). To receive the Lifetime Heat Exchanger Limited Warranty (good for as long as you own your home), 6-Year Unit Replacement Limited Warranty and 12-Year Parts Limited Warranty, online registration must be completed within 60 days of installation. The duration of warranty coverages in Texas differs in some cases.

Additional requirements for annual maintenance are required for the Unit Replacement Limited Warranty. Online registration and some of the additional requirements are not required in California or Québec.

## DM80TN

## Gas Furnace

Up to 80% AFUE

### Standard Features

- » Heavy-duty stainless-steel dual-diameter, tubular heat exchanger
- » Two-stage gas valve provides quiet, economical heating
- » Durable Silicon Nitride igniter
- » Quiet two-speed draft inducer
- » Self-diagnostic control board with constant memory fault code history output to a 3-digit 7 segment LED display and push buttons
- » Energy-efficient multi-speed (9-speed tap) ECM blower motor
- » Multiple continuous fan speed options offer quiet air circulation
- » Cabinet air leakage ( $Q_{Leak}$ )  $\leq 2\%$
- » Fully insulated heat exchanger and blower section
- » California Low NO<sub>x</sub> emissions-compliant models available
- » Can not be installed in California's South Coast Air Quality Management District (SCAQMD) and San Joaquin Valley Air Pollution Control District (SJVAPCD).
- » AHRI Certified; ETL Listed

The Daikin brand DM80TN 9-Speed ECM, Two-Stage gas valve Multi-Speed Multi-Position Gas Furnace provides exceptional indoor comfort and quiet operation. This furnace features a stainless-steel tubular heat exchanger and durable silicon nitride ignition system. With its two-stage gas valves and variable-speed circulator blower, the DM80TN provides comfort all season long.



Model	High-Fire Rate <sup>1</sup>		Low-Fire Rate <sup>1</sup>		AFUE (%)	Tons A/C <sup>2</sup>	MCA	MOP	Dimensions			Ship Weight (lbs)
	Input	Output	Input	Output					W"	D"	H"	
DM80TN0403ANA*	40,000	32,000	28,000	22,400	80	3	8.7	15	14	28	33¾	105
DM80TN0603B*A*	60,000	48,000	42,000	33,600	80	3	8.7	15	17½	28	33¾	107
DM80TN0803B*A*	80,000	64,000	56,000	44,800	80	3	8.7	15	17½	28	33¾	118
DM80TN0805C*A*	80,000	64,000	56,000	44,800	80	5	15.32	20	24½	28	33¾	129
DM80TN0805DXA*	80,000	64,000	56,000	44,800	80	5	15.32	20	21	28	33¾	124
DM80TN1005C*A*	100,000	80,000	70,000	56,000	80	5	15.32	20	24½	28	33¾	124
DM80TN1205DXA*	120,000	96,000	84,000	67,200	80	5	15.32	20	24½	28	33¾	124

<sup>1</sup> BTU/h <sup>2</sup> @ 0.5" ESP

The manufacturing entity reserves the right to discontinue, or change at any time, specifications or designs without notice or without incurring obligations.

# DC80TN

## Gas Furnace

Up to 80% AFUE

### COMFORTABLE LIMITED WARRANTY\* PROTECTION



\* Complete warranty details available from your local dealer/contractor or at [www.daikincomfort.com](http://www.daikincomfort.com). To receive the Lifetime Heat Exchanger Limited Warranty (good for as long as you own your home), 6-Year Unit Replacement Limited Warranty and 12-Year Parts Limited Warranty, online registration must be completed within 60 days of installation. The duration of warranty coverages in Texas differs in some cases.

Additional requirements for annual maintenance are required for the Unit Replacement Limited Warranty. Online registration and some of the additional requirements are not required in California or Québec.

### Standard Features

- » Heavy-duty stainless-steel dual-diameter, tubular heat exchanger
- » Two-stage gas valve provides quiet, economical heating
- » Durable Silicon Nitride igniter
- » Quiet two-speed draft inducer
- » Self-diagnostic control board with constant memory fault code history output to a 3-digit 7 segment LED display and push buttons
- » Energy-efficient multi-speed (9-speed tap) ECM blower motor
- » Multiple continuous fan speed options offer quiet air circulation
- » Cabinet air leakage ( $Q_{Leak}$ )  $\leq 2\%$
- » Fully insulated heat exchanger and blower section
- » All models comply with CA Low NOx standards
- » Can not be installed in California's South Coast Air Quality Management District (SCAQMD) and San Joaquin Valley Air Pollution Control District (SJVAPCD).
- » AHRI Certified; ETL Listed

The Daikin brand DC80TN 9-Speed ECM, Two-Stage gas valve, Multi-Speed Gas Furnace provides exceptional indoor comfort and quiet operation. This furnace features a stainless-steel tubular heat exchanger and durable silicon nitride ignition system. With its two-stage gas valves and variable-speed circulator blowers, the DC80TN provides comfort all season long.



Model	High-Fire Rate <sup>1</sup>		Low-Fire Rate <sup>1</sup>		AFUE (%)	Tons A/C <sup>2</sup>	MCA	MOP	Dimensions			Ship Weight (lbs)
	Input	Output	Input	Output					W"	D"	H"	
DC80TN0403AXA*	40,000	32,000	28,000	22,400	80	3	8.7	15	14	28	33 $\frac{3}{4}$	105
DC80TN0603AXA*	60,000	48,000	42,000	33,600	80	3	8.7	15	14	28	33 $\frac{3}{4}$	107
DC80TN0603BXA*	60,000	48,000	42,000	33,600	80	3	8.7	15	17 $\frac{1}{2}$	28	33 $\frac{3}{4}$	107
DC80TN0804BXA*	80,000	64,000	56,000	44,800	80	4	12.45	15	17 $\frac{1}{2}$	28	33 $\frac{3}{4}$	121
DC80TN0805CXA*	80,000	64,000	56,000	44,800	80	5	15.32	20	21	28	33 $\frac{3}{4}$	129
DC80TN1005CXA*	100,000	80,000	70,000	56,000	80	5	15.32	20	21	28	33 $\frac{3}{4}$	124

<sup>1</sup> BTU/h <sup>2</sup> @ 0.5" ESP

The manufacturing entity reserves the right to discontinue, or change at any time, specifications or designs without notice or without incurring obligations.

COMFORTABLE LIMITED WARRANTY\* PROTECTION



\* Complete warranty details available from your local dealer/contractor or at [www.daikincomfort.com](http://www.daikincomfort.com). To receive the Lifetime Heat Exchanger Limited Warranty (good for as long as you own your home), 6-Year Unit Replacement Limited Warranty and 12-Year Parts Limited Warranty, online registration must be completed within 60 days of installation. The duration of warranty coverages in Texas differs in some cases.

Additional requirements for annual maintenance are required for the Unit Replacement Limited Warranty. Online registration and some of the additional requirements are not required in California or Québec.

DM80SN / DM80SN-U

Gas Furnace  
Up to 80% AFUE

Standard Features

DM80SN / DM80SN-U

- » Multi-position installation: upflow, horizontal left or right
- » Heavy-duty stainless-steel, dual-diameter tubular heat exchanger
- » Single-stage gas valve
- » Durable Hot-surface igniter
- » Quiet, single-speed draft inducer
- » Self-diagnostic control board with constant memory fault code history output to a 3-digit 7 segment LED display and push buttons
- » Color-coded low-voltage terminals
- » Energy-efficient multi-speed (9-speed tap) ECM blower motor
- » AHRI Certified; ETL Listed
- » Cabinet air leakage ( $Q_{Leak}$ )  $\leq 2\%$
- » Foil faced insulated heat exchanger
- » All models comply with CA Low NOx standards

DM80SN

- Can not be installed in California's South Coast Air Quality Management District (SCAQMD) and San Joaquin Valley Air Pollution Control District (SJVAPCD).

The Daikin brand DM80SN / DM80SN-U 9-Speed ECM, Single-Stage gas valve, Variable-Speed Gas Furnace provides exceptional indoor comfort and quiet operation. This furnace features a stainless-steel tubular heat exchanger and durable silicon nitride ignition system. With its two-stage gas valves and variable-speed circulator blowers, the DM80SN / DM80SN-U provides comfort all season long.



DM80SN-U

- All Ultra-Low NOx DM80SN-U models comply with the 14 ng/J emission limit specified in the South Coast Air Quality Management District (SCAQMD) Rule 1111 and San Joaquin Valley Air Pollution Control District (SJVAPCD) Rule 4905. Learn more at [www.aqmd.gov](http://www.aqmd.gov) and [www.valleyair.org](http://www.valleyair.org).

DM80SN

Model	High Fire Rate (BTU/h) <sup>1</sup>		AFUE (%)	Tons A/C <sup>2</sup>	MCA	MOP	Dimensions			Ship Weight (lbs)
	Input	Output					W"	D"	H"	
DM80SE0403AXA*	40,000	32,000	80%	3	8.7	15	14	28	33%	86
DM80SN0603AXA*	60,000	48,000	80%	3	8.7	15	14	28	33%	90
DM80SN0604BXA*	60,000	48,000	80%	4	12.5	15	17½	28	33%	100
DM80SN0803BXA*	80,000	64,000	80%	4	8.7	15	17½	28	33%	108
DM80SN0804BXA*	80,000	64,000	80%	4	12.5	15	17½	28	33%	108
DM80SN0805CXA*	80,000	64,000	80%	5	12.5	15	21	28	33%	116
DM80SN1005CXA*	100,000	80,000	80%	5	12.5	15	21	28	33%	120
DM80SN1205DXA*	120,000	96,000	80%	5	15.3	20	24½	28	33%	132

DM80SN-U

Model	High Fire Rate (BTU/h) <sup>1</sup>		AFUE (%)	Tons A/C <sup>2</sup>	MCA	MOP	Dimensions			Ship Weight (lbs)
	Input	Output					W"	D"	H"	
DM80SN0403AUA*	40,000	32,000	80%	3	8.7	15	14	28	33%	86
DM80SN0603AUA*	60,000	48,000	80%	3	8.7	15	14	28	33%	90
DM80SN0604BUA*	60,000	48,000	80%	4	12.5	15	17½	28	33%	100
DM80SN0804BUA*	80,000	64,000	80%	4	12.5	15	17½	28	33%	108
DM80SN0805CUA*	80,000	64,000	80%	5	15.5	20	21	28	33%	116

<sup>1</sup> BTU/h <sup>2</sup> @ 0.5" ESP

The manufacturing entity reserves the right to discontinue, or change at any time, specifications or designs without notice or without incurring obligations.

UNITARY PRODUCTS

# DC80SN

## Gas Furnace

Up to 80% AFUE

### COMFORTABLE LIMITED WARRANTY\* PROTECTION



\* Complete warranty details available from your local dealer/contractor or at [www.daikincomfort.com](http://www.daikincomfort.com). To receive the Lifetime Heat Exchanger Limited Warranty (good for as long as you own your home), 6-Year Unit Replacement Limited Warranty and 12-Year Parts Limited Warranty, online registration must be completed within 60 days of installation. The duration of warranty coverages in Texas differs in some cases.

Additional requirements for annual maintenance are required for the Unit Replacement Limited Warranty. Online registration and some of the additional requirements are not required in California or Québec.

### Standard Features

- » Multi-position installation: upflow, horizontal left or right
- » Heavy-duty stainless-steel, dual-diameter tubular heat exchanger
- » Single-stage gas valve
- » Durable Hot-surface igniter
- » Quiet, single-speed draft inducer
- » Self-diagnostic control board with constant memory fault code history output to a 3-digit 7 segment LED display and push buttons
- » Color-coded low-voltage terminals
- » Energy-efficient multi-speed (9-speed tap) ECM blower motor
- » Cabinet air leakage (QLeak) ≤ 2%
- » Foil faced insulated heat exchanger
- » All models comply with CA Low NOx standards
- » Can not be installed in California's South Coast Air Quality Management District (SCAQMD) and San Joaquin Valley Air Pollution Control District (SJVAPCD).
- » AHRI Certified; ETL Listed

The Daikin brand DC80SN 9-Speed ECM, Single-Stage gas valve, Multi-Position Gas Furnace features a heavy-duty, stainless-steel, dual-diameter tubular heat exchanger and durable silicon nitride hot-surface ignition system. With a heavy-gauge, reinforced, insulated steel cabinet and durable baked enamel finish, this furnace can be installed in a variety of locations.



Model	High Fire Rate (BTU/h) <sup>1</sup>		AFUE (%)	Tons A/C <sup>2</sup>	MCA	MOP	Dimensions			Ship Weight (lbs)
	Input	Output					W"	D"	H"	
DC80SN0403AXA*	40,000	32,000	80%	3	8.7	15	14	28	33¾"	90
DC80SN0603AXA*	60,000	48,000	80%	3	8.7	15	14	28	33¾"	94
DC80SN0804BXA*	80,000	64,000	80%	4	12.45	15	17½"	28	33¾"	107
DC80SN1005CXA*	100,000	80,000	80%	5	15.3	20	21	28	33¾"	115

<sup>1</sup> BTU/h <sup>2</sup> @ 0.5" ESP

The manufacturing entity reserves the right to discontinue, or change at any time, specifications or designs without notice or without incurring obligations.



# Unitary Air Handlers & Coils



# DMVE

## Air Handler

Multi-Position, Variable-Speed,  
Inverter-Tuned

### COMFORTABLE LIMITED WARRANTY\* PROTECTION



\* Complete warranty details available from your local dealer/contractor or at [www.daikincomfort.com](http://www.daikincomfort.com). To receive the 12-Year Parts Limited Warranty, online registration must be completed within 60 days of installation. Online registration is not required in California or Québec. The duration of warranty coverages in Texas differs in some cases.

### Standard Features

- » Electronic Expansion Valve (EEV) for cooling and heat pump applications
- » Variable-speed ECM indoor blower motor
- » Compatible with the Daikin *One+* and Daikin *One* touch smart thermostats and other Daikin communicating equipment
- » Provides constant CFM over a wide range of static pressure conditions independent of duct system
- » CFM indicator
- » Thermostat provides adjustable low CFM for efficient fan-only operation
- » All-aluminum evaporator coil
- » Fault recall of six most recent faults
- » Improved humidity and comfort control compared to units without ECM or EEV
- » 3 kW – 25 kW electric heater kits
- » Horizontal or vertical configuration capabilities
- » 21 inch depth for easier attic access
- » DecaBDE-free thermoplastic drain pan with secondary drain connections
- » Screw-less sides and back helps to reduce condensation when installed in humid locations
- » Foil-faced insulation covers the internal casing to reduce cabinet condensation
- » Tool-less filter access
- » AHRI certified and ETL listed

The Daikin brand DMVE Multi-Position, Variable-Speed, Inverter-Tuned Air Handler is part of our family of communicating units and is designed specifically for use with 18 and 20 SEER inverter outdoor equipment. This unit's ECM indoor blower motor allows for a soft start and stop, offering a quiet, efficient operation while helping to reduce the cold blast of air upon heating start-up.



Model	Nominal Capacity Range (tons)	Voltage	MCA	MOP	Dimensions			Connection Size		Ship Weight (lbs)
					W"	D"	H"	Liquid"	Suction"	
DMVE24BP1400	2	208/230	4.9/4.9	15/15	17½	21	53⅞	¾"	¾"	115
DMVE36CP1400	3	208/230	6.5/6.5	15/15	21	21	53⅞	¾"	¾"	140
DMVE48DP1400	4	208/230	8.6/8.6	15/15	24½	21	53⅞	¾"	¾"	150
DMVE60DP1400	5	208/230	8.6/8.6	15/15	24½	21	58	¾"	¾"	167

The manufacturing entity reserves the right to discontinue, or change at any time, specifications or designs without notice or without incurring obligations.



DAIKIN *ONE+*  
SMART THERMOSTAT



DAIKIN *ONE TOUCH*  
SMART THERMOSTAT



COMFORTABLE LIMITED WARRANTY\* PROTECTION



\* Complete warranty details available from your local dealer/contractor or at [www.daikincomfort.com](http://www.daikincomfort.com). To receive the 12-Year Parts Limited Warranty, online registration must be completed within 60 days of installation. Online registration is not required in California or Québec. The duration of warranty coverages in Texas differs in some cases.

**Daikin Fit - DFVE**

**Air Handler**

Multi-Position, Variable-Speed

**Standard Features**

- » Electronic Expansion Valve (EEV) for cooling and heat pump applications.
- » 7mm evaporator coil tube size
- » Variable-speed ECM blower motor
- » Compatible with the Daikin *One+* and Daikin *One* touch smart thermostats and other Daikin communicating equipment
- » Provides constant CFM over a wide range of static pressure conditions independent of duct system
- » CFM indicator
- » Thermostat provides adjustable low CFM for efficient fan-only operation
- » All-aluminum evaporator coil
- » Fault recall of six most recent faults
- » Improved humidity and comfort control
- » AHRI certified; ETL listed
- » Cabinet air leakage less than 2.0% at 1.0 inch H<sub>2</sub>O and 1.4% at 0.5 inch H<sub>2</sub>O when tested in accordance with ASHRAE standard 193
- » 3 kW – 25 kW electric heater kits
- » Horizontal or vertical configuration capabilities
- » 21 inch depth for easier attic access
- » DecaBDE-free thermoplastic drain pan with secondary drain connections
- » Screw-less sides and back helps to reduce condensation when installed in humid locations
- » Foil-faced insulation covers the internal casing to reduce cabinet condensation
- » Galvanized and leather grain-embossed finish
- » Glue-less cabinet insulation retention
- » Tool-less filter access

The Daikin brand DFVE Multi-Position, Variable-Speed, Communicating Air Handler with Internal EEV is made for the Daikin *Fit* system. This unit's ECM indoor blower motor allows for a soft start and stop, offering a quiet, efficient operation.



Model	Nominal Capacity Range (tons)	Voltage	MCA	MOP	Dimensions			Connection Size		Ship Weight (lbs)
					W"	D"	H"	Liquid"	Suction"	
DFVE24BP1400	2	208/230-1	4.9/4.9	15/15	17½	21	45	¾"	¾"	115
DFVE36CP1400	3	208/230-1	6.5/6.5	15/15	21	21	53⅞	¾"	¾"	140
DFVE42CP1400	3½	208/230-1	6.5/6.5	15/15	21	21	53⅞	¾"	¾"	140
DFVE48DP1400	4	208/230-1	6.5/6.5	15/15	24½	21	53⅞	¾"	¾"	150
DFVE60DP1400	5	208/230-1	6.5/6.5	15/15	24½	21	58	¾"	¾"	167

The manufacturing entity reserves the right to discontinue, or change at any time, specifications or designs without notice or without incurring obligations.



**DAIKIN ONE+**  
SMART THERMOSTAT



**DAIKIN ONE TOUCH**  
SMART THERMOSTAT

UNITARY PRODUCTS

# DMVT

## Air Handler

Multi-Position, Variable-Speed

COMFORTABLE LIMITED WARRANTY\* PROTECTION



\* Complete warranty details available from your local dealer/contractor or at [www.daikincomfort.com](http://www.daikincomfort.com). To receive the 12-Year Parts Limited Warranty, online registration must be completed within 60 days of installation. Online registration is not required in California or Québec. The duration of warranty coverages in Texas differs in some cases.

### Standard Features

- » Compatible with the Daikin *One+* and Daikin *One* touch smart thermostats and other Daikin communicating equipment
- » Auto configuration of the airflow and tonnage in communicating mode
- » All-aluminum evaporator coil
- » Provides constant CFM over a wide range of static pressure conditions independent of duct system
- » CFM indicator
- » Fault recall of six most recent faults
- » Provides adjustable low CFM for efficient fan-only operation
- » Improved humidity and comfort control
- » Built-in compatibility with multi-stage heat pump and cooling applications
- » AHRI certified; ETL listed

The Daikin brand DMVT Multi-Position, Variable-Speed Air Handler is part of our family of communicating units and optimized for use with the chlorine-free refrigerant, R-410A. This unit's ECM indoor blower motor allows for a soft start and stop, which offers a quiet, efficient operation and helps reduce the cold blast of air upon heating start-up.



Model	Nominal Capacity Range (tons)	Voltage	MCA	MOP	Dimensions			Connection Size		Ship Weight (lbs)
					W"	D"	H"	Liquid"	Suction"	
DMVT24BP1400	1½	208/230-1	4.9/4.9	15/15	17½	21	45	¾"	¾"	129
DMVT30BP1400	2	208/230-1	4.9/4.9	15/15	17½	21	53½	¾"	¾"	129
DMVT36BP1400	2½	208/230-1	6.5/6.5	15/15	17½	21	49	¾"	¾"	129
DMVT36CP1400	3	208/230-1	6.5/6.5	15/15	21	21	45	¾"	¾"	153
DMVT42CP1400	3½	208/230-1	6.5/6.5	15/15	21	21	53½	¾"	¾"	153
DMVT48CP1400	4	208/230-1	6.5/6.5	15/15	21	21	53½	¾"	¾"	153
DMVT48DP1400	4	208/230-1	8.6/8.6	15/15	24½	21	49	¾"	¾"	155
DMVT60DP1400	5	208/230-1	8.6/8.6	15/15	24½	21	53½	¾"	¾"	167

The manufacturing entity reserves the right to discontinue, or change at any time, specifications or designs without notice or without incurring obligations.



DAIKIN *ONE+*  
SMART THERMOSTAT



DAIKIN *ONE TOUCH*  
SMART THERMOSTAT



COMFORTABLE LIMITED WARRANTY\* PROTECTION



\* Complete warranty details available from your local dealer/contractor or at [www.daikincomfort.com](http://www.daikincomfort.com). To receive the 12-Year Parts Limited Warranty, online registration must be completed within 60 days of installation. Online registration is not required in California or Québec. The duration of warranty coverages in Texas differs in some cases.

AMST

Air Handler

Multi-Position, Multi-Speed

Standard Features

- » Maximum four low-voltage wires required for operation in communicating mode
- » Auto configuration of the airflow and tonnage in communicating mode
- » Factory-installed inverter-tuned thermal expansion valves
- » Direct Drive ECM indoor blower motor
- » All-aluminum evaporator coil
- » Provides constant CFM over a wide range of static pressure conditions independent of duct system
- » Provides adjustable low speed for efficient fan-only operation
- » CFM and diagnostic indicator with front-panel sight glass
- » Galvanized leather grain-embossed finish
- » Foil-faced insulation covers the entire blower case to reduce operating sound and cabinet condensation
- » Multi-position installation: upflow or downflow or horizontal
- » AHRI certified; ETL listed

The AMST Multi-Position, 9-Speed ECM air handler with internal TXV is optimized for single-stage AC and HP outdoor units up to 15.2 SEER2.



Model	Nominal Capacity Range (tons)	Voltage	MCA	MOP	Dimensions			Connection Size		Ship Weight (lbs)
					W"	D"	H"	Liquid"	Suction"	
AMST24BU1400**	1½	208/230-1	5.8	15	17½	21	45	¾	¾	112
AMST30BU1400**	2	208/230-1	5.6	15	17½	21	53½	¾	¾	129
AMST36BU1400**	2½	208/230-1	5.6	15	17½	21	49	¾	¾	129
AMST36CU1400**	3	208/230-1	7.1	15	21	21	45	¾	¾	153
AMST42CU1400**	3½	208/230-1	5.9	15	21	21	53½	¾	¾	153
AMST48CU1400**	4	208/230-1	7.1	15	21	21	53½	¾	¾	153
AMST48DU1400**	4	208/230-1	8.6	15	24½	21	49	¾	¾	155
AMST60DU1400**	5	208/230-1	8.6	15	24½	21	53½	¾	¾	167

The manufacturing entity reserves the right to discontinue, or change at any time, specifications or designs without notice or without incurring obligations.

# MBVC

## Air Handler

### Modular Blower

#### COMFORTABLE LIMITED WARRANTY\* PROTECTION



\* Complete warranty details available from your local dealer/contractor or at [www.daikincomfort.com](http://www.daikincomfort.com). To receive the 12-Year Parts Limited Warranty, online registration must be completed within 60 days of installation. Online registration is not required in California or Québec. The duration of warranty coverages in Texas differs in some cases.

#### Standard Features

- » Compatible with the Daikin *One+* and Daikin *One touch* smart thermostats and other Daikin communicating equipment
- » Variable-speed, ECM indoor blower motor
- » Provides constant CFM over a wide range of static pressure conditions independent of duct system
- » CFM indicator
- » Fault recall of six most recent faults
- » Built-in dehumidification feature
- » Blower section usable as an electric furnace
- » 21" deep cabinet for easier attic access
- » Control board includes a blower time-delay in the cooling mode
- » Foil-faced insulation lines the cabinet to help reduce operating sound and cabinet condensation
- » Horizontal or vertical configuration capabilities
- » AHRI Certified; ETL Listed

The Daikin brand MBVC modular blower are tailor made for exceptional energy efficiency. The MBVC's ECM indoor blower motor assemblies increase both installation and application flexibility. Can be matched with cased coils for upflow, downflow, and horizontal applications.



Model	Voltage-Phase	MCA	MOP	Dimensions			Ship Weight (lbs)
				W"	D"	H"	
MBVC1200AA-1	208/230-1	4.3	15	17½	21	26	67
MBVC1600AA-1	208/230-1	6.3	15	21	21	30	80
MBVC2000AA-1	208/230-1	5.8	15	24½	21	30	86

The manufacturing entity reserves the right to discontinue, or change at any time, specifications or designs without notice or without incurring obligations.



DAIKIN *ONE+*  
SMART THERMOSTAT



DAIKIN *ONE TOUCH*  
SMART THERMOSTAT

COMFORTABLE LIMITED WARRANTY\* PROTECTION



\* Complete warranty details available from your local dealer/contractor or at [www.daikincomfort.com](http://www.daikincomfort.com). To receive the 12-Year Parts Limited Warranty, online registration must be completed within 60 days of installation. Online registration is not required in California or Québec. The duration of warranty coverages in Texas differs in some cases.

AWST

Air Handler

Multi-Position, Variable-Speed

Standard Features

- » AWST Models: Equipped with a fully adjustable TXV
- » Installation Options - Wall Mount
- » Direct-drive
- » Multi-speed motors allows air volume variation for heating/cooling
- » Sequence-controlled
- » Rust-resistant nickel chromium heating elements of 3/ 5/ 8 and 10 kW
- » Aluminum tubing coils on all models
- » Cabinet air leakage less than 2.0% at 1.0 inch H<sub>2</sub>O when tested in accordance with ASHRAE standard 19

The Daikin brand AWST air handler is designed to be vertically wall- or stud-mounted. This unit is equipped with a fully adjustable TXV and direct-drive, multi-speed motor. The AWST is housed in a fully insulated, galvanized-steel cabinet. Supports 2023 DOE Energy Efficiency Standards.



Model	Nominal Capacity Range (tons)	Electric Heat (kW)	Voltage/Phase	MCA	MOP	Dimensions			Connection Size		Ship Weight (lbs)
						W"	D"	H"	Liquid"	Suction"	
AWST18SU1403 AA	1½	3	208/230-1	17/18.9	20/20	20¾ <sub>16</sub>	16½	36	¾	¾	84
AWST18SU1405 AA	1½	5	208/230-1	24.9/28	25/30	20¾ <sub>16</sub>	16½	36	¾	¾	84
AWST18SU1408 AA	1½	8	208/230-1	36/41.3	40/45	20¾ <sub>16</sub>	16½	36	¾	¾	84
AWST24SU1405 AA	2	5	208/230-1	24.9/28	25/30	20¾ <sub>16</sub>	16½	36	¾	¾	84
AWST24SU1408 AA	2	8	208/230-1	36/41.3	40/45	20¾ <sub>16</sub>	16½	36	¾	¾	84
AWST24SU1410 AA	2	10	208/230-1	47.5/54	50/60	20¾ <sub>16</sub>	16½	36	¾	¾	84
AWST30LU1405 AA	2½	5	208/230-1	26/29.8	30/30	24	21	36	¾	¾	109
AWST30LU1408 AA	2½	8	208/230-1	37.8/43	40/45	24	21	36	¾	¾	109
AWST30LU1410 AA	2½	10	208/230-1	49/55.8	50/60	24	21	36	¾	¾	109
AWST36LU1405 AA	3	5	208/230-1	26/29.8	30/30	24	21	36	¾	¾	109
AWST36LU1408 AA	3	8	208/230-1	37.8/43	40/45	24	21	36	¾	¾	109
AWST36LU1410 AA	3	10	208/230-1	49/55.8	50/60	24	21	36	¾	¾	109

The manufacturing entity reserves the right to discontinue, or change at any time, specifications or designs without notice or without incurring obligations.

UNITARY PRODUCTS

# AWSF

## Air Handler

### Wall-Mount

COMFORTABLE LIMITED WARRANTY\* PROTECTION



\* Complete warranty details available from your local dealer/contractor or at [www.daikincomfort.com](http://www.daikincomfort.com). To receive the 12-Year Parts Limited Warranty, online registration must be completed within 60 days of installation. Online registration is not required in California or Québec. The duration of warranty coverages in Texas differs in some cases.

#### Standard Features

- » AWSF Models: Equipped with a Check Flowrator
- » Direct-drive, multi-speed motors allows air volume variation for heating/cooling
- » Sequence-controlled, rust-resistant nickel chromium heating elements of 5, 8, and 10 kW
- » Aluminum tubing coils on all models
- » Cabinet air leakage less than 2.0% at 1.0 inch H<sub>2</sub>O when tested in accordance with ASHRAE standard 193
- » Cabinet air leakage less than 1.4% at 0.5 inch H<sub>2</sub>O when tested in accordance with ASHRAE standard 193
- » Factory-installed pull-type disconnect
- » Thermoplastic drain pan with bottom primary and secondary drain connections
- » Built-in filter rack (filter included)
- » Large chassis (2½- and 3-ton units) – front return only
- » Small chassis (1½- and 2-ton units) – front or bottom return
- » Wall-hanging bracket provided
- » AHRI Certified; ETL Listed

The Daikin brand AWSF Air Handlers are designed to be vertically wall or stud mounted. The AWSF is housed in a fully insulated, galvanized-steel cabinet.



Model	Nominal Capacity Range (tons)	Electric Heat (kW)	Voltage-Phase	MCA	MOP	Dimensions			Connection Size		Ship Weight (lbs)
						W"	D"	H"	Liquid"	Suction"	
AWSF18SU1605	1½	5	208/230	24.9/28	25/30	20¾	16½	36	¾	¾	84
AWSF18SU1608	1½	8	208/230	36/41.3	40/45	20¾	16½	36	¾	¾	84
AWSF24SU1605	2	5	208/230	24.9/28	25/30	20¾	16½	36	¾	¾	84
AWSF24SU1608	2	8	208/230	36/41.3	40/45	20¾	16½	36	¾	¾	84
AWSF24SU1610	2	10	208/230	46.6/53	50/60	20¾	16½	36	¾	¾	84
AWSF30LU1605	2½	5	208/230	26/29.8	30/30	24	21	36	¾	¾	109
AWSF30LU1608	2½	8	208/230	37.7/43	40/45	24	21	36	¾	¾	109
AWSF30LU1610	2½	10	208/230	48/54.8	50/60	24	21	36	¾	¾	109
AWSF36LU1605	3	5	208/230	26/29.8	30/30	24	21	36	¾	¾	109
AWSF36LU1608	3	8	208/230	37.7/43	40/45	24	21	36	¾	¾	109
AWSF36LU1610	3	10	208/230	48/54.8	50/60	24	21	36	¾	¾	109

The manufacturing entity reserves the right to discontinue, or change at any time, specifications or designs without notice or without incurring obligations.



COMFORTABLE LIMITED WARRANTY\* PROTECTION



\* Complete warranty details available from your local dealer/contractor or at [www.daikincomfort.com](http://www.daikincomfort.com). To receive the 12-Year Parts Limited Warranty, online registration must be completed within 60 days of installation. Online registration is not required in California or Québec. The duration of warranty coverages in Texas differs in some cases.

ACSF

Air Handler  
Ceiling-Mount

Standard Features

- » All-Aluminum tube/aluminum fin coil
- » Direct-drive, resilient-mount, multi-speed motor
- » Sequence-controlled and rust-resistant nickel chromium heating elements
- » AHRI Certified; ETL Listed
- » Primary/secondary drain connection in a high-temperature plastic drain pan
- » Suitable for free-return installation (non-ducted return air)
- » Galvanized-steel construction
- » Factory-installed pull-type disconnect
- » Easy service access of 5, 6, 8 and 10 kW
- » High-efficiency evaporator coil
- » Quiet operation

The Daikin brand ACSF Electric Heat Air Handler is designed to be ceiling-mounted. This unit features a check flowrate and direct-drive, resilient-mount, multi-speed motor. The ACSF has galvanized-steel construction and quiet operation.

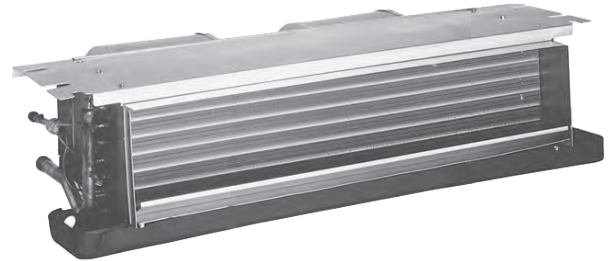

Model	Nominal Capacity Range (tons)	Electric Heat (kW)	Voltage (VAC)	MCA	MOP	Dimensions			Connection Size		Ship Weight (lbs)
						W"	D"	H"	Liquid	Suction	
ACSF18MN1605AA	1½	5	208/230	28.5/25	30/30	43¼	21	10	¾	¾	69
ACSF18MN1608AA	1½	8	208/230	44/38.6	45/40	43¼	21	10	¾	¾	69
ACSF24LN1605AA	2	5	208/230	28.5/25	30/30	49¼	21	10	¾	¾	79
ACSF24LN1606AA	2	6	208/230	34/29.6	35/30	49¼	21	10	¾	¾	79
ACSF24LN1608AA	2	8	208/230	44/38.6	45/40	49¼	21	10	¾	¾	79
ACSF24LN1610AA	2	10	208/230	54.6/48.0	60/50	49¼	21	10	¾	¾	79
ACSF30LN1605AA	2½	5	208/230	28.5/ 25	30/30	49¼	21	10	¾	¾	79
ACSF30LN1606AA	2½	6	208/230	34/29.6	35/30	49¼	21	10	¾	¾	79
ACSF30LN1608AA	2½	8	208/230	44/38.6	45/40	49¼	21	10	¾	¾	79
ACSF30LN1610AA	2½	10	208/230	54.6/48	60/50	49¼	21	10	¾	¾	79

The manufacturing entity reserves the right to discontinue, or change at any time, specifications or designs without notice or without incurring obligations.

UNITARY PRODUCTS

# CAPEA / CAPE

## Cased Indoor Coil

COMFORTABLE LIMITED WARRANTY\* PROTECTION



\* Complete warranty details available from your local dealer/contractor or at [www.daikincomfort.com](http://www.daikincomfort.com). To receive the 12-Year Parts Limited Warranty, online registration must be completed within 60 days of installation. Online registration is not required in California or Québec. The duration of warranty coverages in Texas differs in some cases.

### Standard Features

- » Compatible with Daikin *One+* and Daikin *One* touch smart thermostats and other Daikin communicating equipment
- » Electronic Expansion Valve (EEV) models feature
  - Cooling and heat pump applications
  - Fault recall of six most recent faults
- » All-aluminum evaporator coil
  - 7mm evaporator coil tube size (CAPEA)
- » Galvanized, leather grain-embossed finish
- » Rust-resistant, high-temperature, thermoplastic drain pans feature a low water-retention design
- » Upflow/downflow configuration
- » 21" depth for easier attic access
- » Foil-faced insulation covers the internal casing to reduce cabinet condensation
- » Split-seam front for easy access (CAPE only)
- » DecaBDE-free UV-resistant drain pan
- » UV-resistant drain pan
- » AHRI certified; ETL listed

The Daikin brand All-aluminum CAPEA and CAPE Cased Upflow/Downflow Indoor Coils are made for the Daikin *Fit* system. This unit features aluminum tubing and corrugated aluminum fin coils and rust-resistant, high-temperature, thermoplastic drain pans. The CAPEA and CAPE cabinets are painted nickel gray.



### CAPEA- Utilized by DX6VS & DZ6VS

Model	Dimensions			Nominal Capacity Range (tons)	Connection Size		Ship Weight (lbs)
	W"	D"	H"		Liquid"	Suction"	
CAPEA1818B4	17½	21½	18	1½ - 2	¾	¾	43
CAPEA1818C4	21	21½	18	1½ - 2	¾	¾	45
CAPEA2422B4	17½	21½	22	2 - 2½	¾	¾	48
CAPEA2422C4	21	21½	22	2 - 2½	¾	¾	51
CAPEA3026B4	17½	21½	26	3	¾	¾	54
CAPEA3026C4	21	21½	26	3	¾	¾	57
CAPEA3026D4	24½	21½	26	3	¾	¾	62

The manufacturing entity reserves the right to discontinue, or change at any time, specifications or designs without notice or without incurring obligations.

### CAPE- Utilized by DX6VS only

Model	Dimensions			Nominal Capacity Range (tons)	Connection Size		Ship Weight (lbs)
	W"	D"	H"		Liquid"	Suction"	
CAPE4860C4	21	21½	30	3½ - 4	¾	¾	71
CAPE4860D4	24½	21½	30	3½ - 4	¾	¾	73
CAPE4961C4	21	21½	30	4 - 5	¾	¾	78
CAPE4961D4	24½	21½	30	4 - 5	¾	¾	80

The manufacturing entity reserves the right to discontinue, or change at any time, specifications or designs without notice or without incurring obligations.



DAIKIN **ONE+**  
SMART THERMOSTAT



DAIKIN **ONE TOUCH**  
SMART THERMOSTAT

COMFORTABLE LIMITED WARRANTY\* PROTECTION



\* Complete warranty details available from your local dealer/contractor or at [www.daikincomfort.com](http://www.daikincomfort.com). To receive the 12-Year Parts Limited Warranty, online registration must be completed within 60 days of installation. Online registration is not required in California or Québec. The duration of warranty coverages in Texas differs in some cases.

# CAPT Cased Indoor Coil

## Standard Features

- » Internal factory-installed thermal expansion valves (TXV) for cooling and heat pump applications
- » Rust-resistant, high-temperature, thermoplastic drain pans feature a low water-retention design
- » All-aluminum evaporator coil
- » Rifled aluminum tubing and corrugated aluminum fin coil
- » Galvanized, leather grain-embossed finish
- » 21" depth for easier attic access
- » Upflow/downflow configuration
- » Foil-faced insulation covers the internal casing to reduce cabinet condensation
- » High-quality post-paint cabinet
- » Split-seam front for easy access
- » AHRI certified; ETL listed

The Daikin brand All-aluminum CAPT Cased coils with TXV option are made for split system air conditioners and heat pumps. This unit features aluminum tubing and corrugated aluminum fin coils and rust-resistant, high-temperature, thermoplastic drain pans. The CAPT cabinet is painted nickel gray.



Model	Cabinet Dimensions			Nominal Capacity Range (tons)	Connection Size		Ship Weight (lbs)
	W"	D"	H"		Liquid"	Suction"	
CAPT4961C4	21	21	30	3-5	3/8"	3/8"	73
CAPT4961D4	24 1/2	21	30	3-5	3/8"	3/8"	76

The manufacturing entity reserves the right to discontinue, or change at any time, specifications or designs without notice or without incurring obligations.

UNITARY PRODUCTS

# CAPTA

## Cased Indoor Coil

### COMFORTABLE LIMITED WARRANTY\* PROTECTION



\* Complete warranty details available from your local dealer/contractor or at [www.daikincomfort.com](http://www.daikincomfort.com). To receive the 12-Year Parts Limited Warranty, online registration must be completed within 60 days of installation. Online registration is not required in California or Québec. The duration of warranty coverages in Texas differs in some cases.

#### Standard Features

- » Internal factory-installed thermal expansion valves (TXV) for cooling and heat pump applications
- » Rust-resistant high-temperature thermoplastic drain pans feature a low water-retention design
- » All-aluminum evaporator coil
- » Check flowrate for cooling and heat pump applications
- » Rifled aluminum tubing and corrugated aluminum fin coil
- » Galvanized and leather grain-embossed finish
- » 21-inch depth for easier attic access
- » Upflow/downflow configuration
- » Foil-faced insulation covers the internal casing to reduce cabinet condensation
- » High-quality post-paint cabinet
- » AHRI certified; ETL listed

The Daikin brand All-aluminum CAPTA Cased Upflow/Downflow Cased coils with factory installed TXV are made for split system air conditioners and heat pumps. This unit features aluminum tubing, corrugated aluminum fin coils and rust-resistant, high temperature, thermoplastic drain pans. The CAPTA cabinet is painted nickel gray.



Model	Cabinet Dimensions			Nominal Tons	Connection Size		Ship Weight (lbs)
	W"	D"	H"		Liquid"	Suction"	
CAPTA1818A4	14	21	18	1½	¾	¾	36
CAPTA1818B4	17½	21	18	1½	¾	¾	41
CAPTA2422A4	14	21	22	2	¾	¾	44
CAPTA2422B4	17½	21	22	2	¾	¾	48
CAPTA2422C4	21	21	22	2	¾	¾	53
CAPTA3022A4	14	21	22	2½	¾	¾	44
CAPTA3022B4	17½	21	22	2½	¾	¾	48
CAPTA3022C4	21	21	22	2½	¾	¾	53
CAPTA3026B4	17½	21	26	2½	¾	¾	50
CAPTA3026C4	21	21	26	2½	¾	¾	52
CAPTA3626B4	17½	21	26	3	¾	¾	54
CAPTA3626C4	21	21	26	3	¾	¾	57
CAPTA4230C4	21	21	30	3½	¾	¾	63
CAPTA4230D4	24½	21	30	23	¾	¾	66

The manufacturing entity reserves the right to discontinue, or change at any time, specifications or designs without notice or without incurring obligations.



COMFORTABLE LIMITED WARRANTY\* PROTECTION



\* Complete warranty details available from your local dealer/contractor or at [www.daikincomfort.com](http://www.daikincomfort.com). To receive the 12-Year Parts Limited Warranty, online registration must be completed within 60 days of installation. Online registration is not required in California or Québec. The duration of warranty coverages in Texas differs in some cases.

CAPFA

Cased Indoor Coil

Standard Features

- » Check flowrate for cooling and heat pump applications
- » All-aluminum evaporator coil
- » 7mm tubes designed with patented grooves to maximize heat transfer
- » Galvanized, leather grain-embossed finish
- » Rust-resistant, high-temperature, thermoplastic drain pans feature a low water-retention design
- » Upflow/downflow configuration
- » 21" depth for easier attic access
- » Foil-faced insulation covers the internal casing to reduce cabinet condensation
- » DecaBDE-free UV-resistant drain pan
- » UV-resistant drain pan
- » AHRI certified; ETL listed

The Daikin brand All-aluminum CAPFA Cased Upflow/Downflow Indoor Coils are made for split system air conditioners and heat pumps. This unit features aluminum tubing and corrugated aluminum fin coils and rust-resistant, high-temperature, thermoplastic drain pans. The CAPFA cabinet is painted nickel gray.



Model	Dimensions			Nominal Capacity Range (tons)	Connection Size		Ship Weight (lbs)
	W"	D"	H"		Liquid"	Suction"	
CAPFA1818A6	14	21	18	1½	¾	¾	33
CAPFA1818B6	17½	21	18	1½	¾	¾	38
CAPFA1818C6	21	21	18	1½	¾	¾	43
CAPFA2418A6	14	21	18	1½ - 2	¾	¾	33
CAPFA2418B6	17½	21	18	1½ - 2	¾	¾	38
CAPFA2418C6	21	21	18	1½ - 2	¾	¾	43
CAPFA2422A6	14	21	18	2	¾	¾	41
CAPFA2422B6	17½	21	22	2	¾	¾	45
CAPFA2422C6	21	21	22	2	¾	¾	50
CAPFA3022A6	14	21	22	2 - 2½	¾	¾	41
CAPFA3022B6	17½	21	22	2 - 2½	¾	¾	45
CAPFA3022C6	21	21	22	2 - 2½	¾	¾	50
CAPFA3022D6	24½	21	22	2 - 2½	¾	¾	52
CAPFA3626B6	17½	21	26	2 - 3	¾	¾	47
CAPFA3626C6	21	21	26	2 - 3	¾	¾	49
CAPFA3626D6	24½	21	26	2 - 3	¾	¾	56
CAPFA4226B6	17½	21	26	3 - 3½	¾	¾	51
CAPFA4226C6	21	21	26	3 - 3½	¾	¾	54
CAPFA4226D6	24½	21	26	3 - 3½	¾	¾	59

The manufacturing entity reserves the right to discontinue, or change at any time, specifications or designs without notice or without incurring obligations.

UNITARY PRODUCTS

# CAPF

## Cased Indoor Coil

### COMFORTABLE LIMITED WARRANTY\* PROTECTION



\* Complete warranty details available from your local dealer/contractor or at [www.daikincomfort.com](http://www.daikincomfort.com). To receive the 12-Year Parts Limited Warranty, online registration must be completed within 60 days of installation. Online registration is not required in California or Québec. The duration of warranty coverages in Texas differs in some cases.

#### Standard Features

- » Check flowrate for cooling and heat pump applications
- » Rifled aluminum tubing and corrugated aluminum fin coil
- » All-aluminum evaporator coil
- » Galvanized, leather grain-embossed finish
- » Rust-resistant, high-temperature, thermoplastic drain pans feature a low water-retention design
- » Upflow/downflow configuration
- » 21" depth for easier attic access
- » Foil-faced insulation covers the internal casing to reduce cabinet condensation
- » Split-seam front for easy access
- » DecaBDE-free UV-resistant drain pan
- » UV-resistant drain pan
- » AHRI certified; ETL listed

The Daikin brand All-aluminum CAPF Cased Upflow/Downflow Indoor Coils are made for split system air conditioners and heat pumps. This unit features aluminum tubing and corrugated aluminum fin coils and rust-resistant, high-temperature, thermoplastic drain pans. The CAPF cabinet is painted nickel gray.



Model	Dimensions			Nominal Capacity Range (tons)	Connection Size		Ship Weight (lbs)
	W"	D"	H"		Liquid"	Suction"	
CAPF3137B6	17½	21	30	2½ - 3	¾	¾	53
CAPF3743C6	21	21	30	2½ - 3½	¾	¾	63
CAPF3743D6	24½	21	30	2½ - 3½	¾	¾	75
CAPF4860C6	21	21	30	3 - 5	¾	¾	65
CAPF4860D6	24½	21	30	3 - 5	¾	¾	68
CAPF4961C6	21	21	30	3½ - 5	¾	¾	73
CAPF4961D6	24½	21	30	3½ - 5	¾	¾	76

The manufacturing entity reserves the right to discontinue, or change at any time, specifications or designs without notice or without incurring obligations.

COMFORTABLE LIMITED  
WARRANTY\* PROTECTION



\* Complete warranty details available from your local dealer/contractor or at [www.daikincomfort.com](http://www.daikincomfort.com). To receive the 12-Year Parts Limited Warranty, online registration must be completed within 60 days of installation. Online registration is not required in California or Québec. The duration of warranty coverages in Texas differs in some cases.

CAUFA

Uncased Indoor Coil

Standard Features

- » Check flowrate for cooling and heat pump applications
- » All-aluminum evaporator coil
- » Rifled aluminum tubing and corrugated aluminum fin coil
- » 21" depth for easier attic access
- » Upflow/downflow configuration
- » Rust-resistant, high-temperature, thermoplastic drain pans feature a low water-retention design
- » UV-resistant drain pan
- » AHRI certified; ETL listed

The Daikin brand All-aluminum CAUFA Uncased Upflow/Downflow Indoor Coils are made for split system air conditioners and heat pumps. This coil features aluminum tubing and corrugated aluminum fins and rust-resistant, high-temperature, thermoplastic drain pan.

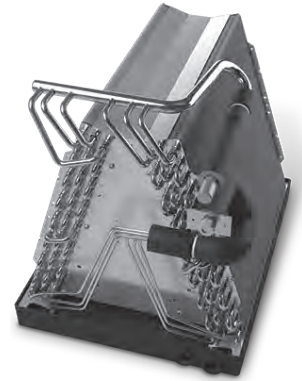

Model	Dimensions			Nominal Capacity Range (tons)	Connection Size		Ship Weight (lbs)
	W"	D"	H"		Liquid"	Suction"	
CAUFA1714A6	12½	20	11¼	1½	¾	¾	16
CAUFA1714B6	16	20	11	1½	¾	¾	18
CAUFA1818A6	12½	20	14¾	1½	¾	¾	18
CAUFA1818B6	16	20	14½	1½	¾	¾	20
CAUFA1818C6	19.5	20	14¼	1½	¾	¾	26
CAUFA2318A6	12½	20	14¾	1½ - 2	¾	¾	18
CAUFA2318B6	16	20	14½	1½ - 2	¾	¾	20
CAUFA2318C6	19.5	20	14¼	1½ - 2	¾	¾	26
CAUFA2418A6	12½	20	14¾	1½ - 2	¾	¾	18
CAUFA2418B6	16	20	14½	1½ - 2	¾	¾	20
CAUFA2418C6	19½	20	14¼	1½ - 2	¾	¾	26
CAUFA2422A6	12½	20	18	2	¾	¾	26
CAUFA2422B6	16	20	17¾	2	¾	¾	28
CAUFA2422C6	19½	20	17½	2	¾	¾	30
CAUFA2922A6	12½	20	17½	2½	¾	¾	26
CAUFA2922B6	16	20	17¾	2½	¾	¾	28
CAUFA2922C6	19½	20	17½	2½	¾	¾	30
CAUFA3022A6	12½	20	18	2 - 2½	¾	¾	26
CAUFA3022B6	16	20	17¾	2 - 2½	¾	¾	28
CAUFA3022C6	19½	20	17½	2 - 2½	¾	¾	30
CAUFA3022D6	23	20	17¼	2 - 2½	¾	¾	32
CAUFA3526B	16	20	21	2 - 3	¾	¾	30
CAUFA3526C	19½	20	20¾	2 - 3	¾	¾	31
CAUFA3626B6	16	20	21	2 - 3	¾	¾	30
CAUFA3626C6	19½	20	20¾	2 - 3	¾	¾	31
CAUFA3626D6	23	20	20¾	2 - 3	¾	¾	35
CAUFA4226B6	16	20	24¾	3 - 3½	¾	¾	28
CAUFA4226C6	19½	20	24	3 - 3½	¾	¾	30
CAUFA4226D6	23	20	23¾	3 - 3½	¾	¾	33

The manufacturing entity reserves the right to discontinue, or change at any time, specifications or designs without notice or without incurring obligations.

UNITARY PRODUCTS

# CAUF

## Uncased Indoor Coil

COMFORTABLE LIMITED  
WARRANTY\* PROTECTION



\* Complete warranty details available from your local dealer/contractor or at [www.daikincomfort.com](http://www.daikincomfort.com). To receive the 12-Year Parts Limited Warranty, online registration must be completed within 60 days of installation. Online registration is not required in California or Québec. The duration of warranty coverages in Texas differs in some cases.

### Standard Features

- » Check flowrate for cooling and heat pump applications
- » All-aluminum evaporator coil
- » Rifled aluminum tubing and corrugated aluminum fin coil
- » 21" depth for easier attic access
- » Upflow/downflow configuration
- » Rust-resistant, high-temperature, thermoplastic drain pans feature a low water-retention design
- » UV-resistant drain pan
- » AHRI certified; ETL listed

The Daikin brand All-aluminum CAUF Uncased Upflow/Downflow Indoor Coils are made for split system air conditioners and heat pumps. This coil features aluminum tubing and corrugated aluminum fins and rust-resistant, high-temperature, thermoplastic drain pan.

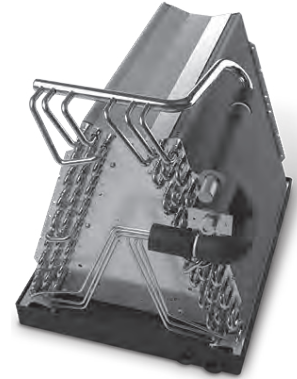

Model	Dimensions			Nominal Capacity Range (tons)	Connection Size		Ship Weight (lbs)
	W"	D"	H"		Liquid"	Suction"	
CAUF3137B6	16½	20⅞	27	2½ - 3	¾	¾	53
CAUF3743C6	20	20⅞	28 <sup>1</sup> / <sub>16</sub>	2½ - 3½	¾	¾	46
CAUF3743D6	23	20⅞	27 <sup>9</sup> / <sub>8</sub>	2½ - 3½	¾	¾	43
CAUF4860C6	20	20⅞	28	3 - 5	¾	¾	48
CAUF4860D6	23	20⅞	28	3 - 5	¾	¾	39
CAUF4961C6	20	20⅞	28	3½ - 5	¾	¾	54
CAUF4961D6	23	20⅞	27	3½ - 5	¾	¾	59

The manufacturing entity reserves the right to discontinue, or change at any time, specifications or designs without notice or without incurring obligations.



COMFORTABLE LIMITED WARRANTY\* PROTECTION



\* Complete warranty details available from your local dealer/contractor or at [www.daikincomfort.com](http://www.daikincomfort.com). To receive the 12-Year Parts Limited Warranty, online registration must be completed within 60 days of installation. Online registration is not required in California or Québec. The duration of warranty coverages in Texas differs in some cases.

CHPE

Cased Indoor Coil

Standard Features

- » Electronic Expansion Valve (EEV) models feature
  - Compatibility with Daikin *One+* and Daikin *One* touch smart thermostats and other Daikin communicating equipment
  - Cooling and heat pump applications
  - Fault recall of six most recent faults
- » All-aluminum evaporator coil
- » Galvanized, leather grain-embossed finish
- » Rust-resistant, high-temperature, thermoplastic drain pans feature a low water-retention design
- » Dedicated Horizontal configuration
- » 21" depth for easier attic access
- » Foil-faced insulation covers the internal casing to reduce cabinet condensation
- » UV-resistant drain pan
- » Split-seam front for easy access
- » AHRI certified; ETL listed

The Daikin brand All-aluminum CHPE Cased Horizontal "A" Coils are made for the Daikin *Fit* air conditioner system. Each coil is made of quality galvanized steel with a painted, leather grain-embossed finish. This cabinet is painted Architectural Gray.

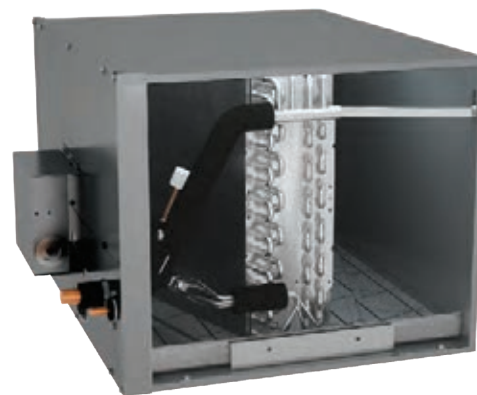

CHPE - Utilized by DX6VS only

Model	Cabinet Dimensions			Nominal Capacity Range (tons)	Connection Size		Ship Weight (lbs)
	W"	D"	H"		Liquid"	Suction"	
CHPE2430B4	21 <sup>1</sup> / <sub>8</sub>	26	17 <sup>1</sup> / <sub>2</sub>	1 <sup>1</sup> / <sub>2</sub>	3/8"	3/4"	56
CHPE3636B4	21 <sup>1</sup> / <sub>8</sub>	26	17 <sup>1</sup> / <sub>2</sub>	2 - 3	3/8"	3/4"	59
CHPE3642C4	21 <sup>1</sup> / <sub>8</sub>	26	21	2 - 3	3/8"	3/4"	62
CHPE3743C4	21 <sup>1</sup> / <sub>8</sub>	26	21	3 - 4	3/8"	7/8"	68
CHPE3743D4	21 <sup>1</sup> / <sub>8</sub>	26	24 <sup>1</sup> / <sub>2</sub>	3 - 3 <sup>1</sup> / <sub>2</sub>	3/8"	7/8"	72
CHPE4860D4	21 <sup>1</sup> / <sub>8</sub>	26	24 <sup>1</sup> / <sub>2</sub>	4 - 5	3/8"	7/8"	79

The manufacturing entity reserves the right to discontinue, or change at any time, specifications or designs without notice or without incurring obligations.



DAIKIN *ONE+* SMART THERMOSTAT



DAIKIN *ONE TOUCH* SMART THERMOSTAT

UNITARY PRODUCTS

# CHPF

## Cased Indoor Coil

COMFORTABLE LIMITED  
WARRANTY\* PROTECTION



\* Complete warranty details available from your local dealer/contractor or at [www.daikincomfort.com](http://www.daikincomfort.com). To receive the 12-Year Parts Limited Warranty, online registration must be completed within 60 days of installation. Online registration is not required in California or Québec. The duration of warranty coverages in Texas differs in some cases.

### Standard Features

- » Check flowrate for cooling and heat pump applications
- » All-aluminum evaporator coil
- » Rust-resistant, high-temperature, thermoplastic drain pans feature a low water-retention design
- » Galvanized, leather grain-embossed finish
- » Horizontal configuration
- » 21" depth for easier attic access
- » Foil-faced insulation covers the internal casing to reduce cabinet condensation
- » UV-resistant drain pan
- » Split-seam front for easy access
- » AHRI certified; ETL listed

The Daikin brand All-aluminum CHPF Cased Horizontal "A" Coils are made for split system air conditioners and heat pumps. Each coil is made of quality galvanized steel with a painted, leather grain-embossed finish. This cabinet is painted Architectural Gray.



Model	Cabinet Dimensions			Nominal Capacity Range (tons)	Connection Size		Ship Weight (lbs)
	W"	D"	H"		Liquid"	Suction"	
CHPF1824A6	21 $\frac{1}{8}$	26	14	1 $\frac{1}{2}$ - 2	$\frac{3}{8}$	$\frac{3}{4}$	36
CHPF2430B6	21 $\frac{1}{8}$	26	17 $\frac{1}{2}$	1 $\frac{1}{2}$ - 2 $\frac{1}{2}$	$\frac{3}{8}$	$\frac{3}{4}$	55
CHPF3636B6	21 $\frac{1}{8}$	26	17 $\frac{1}{2}$	1 $\frac{1}{2}$ - 3	$\frac{3}{8}$	$\frac{3}{4}$	50
CHPF3642C6	21 $\frac{1}{8}$	26	21	2 - 3 $\frac{1}{2}$	$\frac{3}{8}$	$\frac{3}{4}$	63
CHPF3743C6	21 $\frac{1}{8}$	26	21	2 - 3 $\frac{1}{2}$	$\frac{3}{8}$	$\frac{7}{8}$	63
CHPF4860D6	21 $\frac{1}{8}$	26	24 $\frac{1}{2}$	3 - 5	$\frac{3}{8}$	$\frac{7}{8}$	77

The manufacturing entity reserves the right to discontinue, or change at any time, specifications or designs without notice or without incurring obligations.

COMFORTABLE LIMITED  
WARRANTY\* PROTECTION



\* Complete warranty details available from your local dealer/contractor or at [www.daikincomfort.com](http://www.daikincomfort.com). To receive the 12-Year Parts Limited Warranty, online registration must be completed within 60 days of installation. Online registration is not required in California or Québec. The duration of warranty coverages in Texas differs in some cases.

# CHPT / CHPTA

## Cased Horizontal Indoor Coils

### Standard Features

- » Check flowrate for cooling and heat pump applications
- » All-aluminum evaporator coil
- » Rifled aluminum tubing and corrugated aluminum fin coil
- » 21" depth for easier attic access
- » Upflow/downflow configuration
- » Rust-resistant, high-temperature, thermoplastic drain pans feature a low water-retention design
- » UV-resistant drain pan
- » AHRI certified; ETL listed

The Daikin brand All-aluminum CHPT/CHPTA Cased Horizontal "A" Coils with factory installed TXV are made for split system air conditioners and heat pumps. This unit features aluminum tubing, corrugated aluminum fin coils and rust-resistant, high temperature, thermoplastic drain pans. The CHPT/CHPTA cabinet is painted nickel gray.



Model	Dimensions			Nominal Capacity Range (tons)	Connection Size		Ship Weight (lbs)
	W"	D"	H"		Liquid"	Suction"	
CHPTA1822A4	22"	21"	14"	1½	¾"	¾"	48
CHPTA1822B4	22"	21"	17½"	1½	¾"	¾"	52
CHPTA2426B4	26"	21"	17½"	2	¾"	7⁄8"	57
CHPTA2426C4	26"	21"	21"	2	¾"	7⁄8"	59
CHPTA3026B4	26"	21"	17½"	2½	¾"	7⁄8"	61
CHPTA3026C4	26"	21"	21"	2½	¾"	7⁄8"	64
CHPTA3630B4	30"	21"	17½"	3	¾"	7⁄8"	66
CHPTA3630C4	30"	21"	21"	3	¾"	7⁄8"	70
CHPT4860D4**	26"	21½"	24½"	3½ - 5	¾"	7⁄8"	81

Note: For a properly matched system and piston sizing information, refer to Daikin piston kit chart of the corresponding Daikin outdoor unit.



\* Complete warranty details available from your local dealer/contractor or at [www.daikincomfort.com](http://www.daikincomfort.com). To receive the 12-Year Parts Limited Warranty, online registration must be completed within 60 days of installation. Online registration is not required in California or Québec. The duration of warranty coverages in Texas differs in some cases.

**Standard Features**

- » Check flowrater for cooling and heat pump applications
- » All-aluminum evaporator coil
- » Rust-resistant, high-temperature, thermoplastic drain pan with secondary drain connection
- » Foil-faced insulation covers the internal casing to reduce cabinet condensation
- » Compact, versatile, right or left horizontal position
- » Copper sweat connections
- » UV-resistant drain pan
- » AHRI certified; ETL listed

The Daikin brand CSCF Horizontal Slab Evaporator Coils are made for split system air conditioners and heat pumps. This unit features a check flowrater expansion device and rust-resistant, high-temperature, thermoplastic drain pan. Each coil's cabinet has a quality, galvanized-steel finish.



Model	Cabinet Dimensions			Nominal Capacity Range (tons)	Connection Size		Ship Weight (lbs)
	W"	D"	H"		Liquid"	Suction"	
CSCF1824N6	25½	12	25	1½ - 2	¾	¾	43
CSCF3036N6	33½	12	25	1½ - 2½	¾	¾	53
CSCF3642N6	39½	12	25	2½ - 3½	¾	¾	43
CSCF4860N6	39½	12	25	3 - 5	¾	¾	60

*The manufacturing entity reserves the right to discontinue, or change at any time, specifications or designs without notice or without incurring obligations.*





# Unitary Packaged Units



# DP3CH

## Packaged Air Conditioner

13.4 SEER2

### COMFORTABLE LIMITED WARRANTY\* PROTECTION



\* Complete warranty details available from your local dealer/contractor or at [www.daikincomfort.com](http://www.daikincomfort.com). To receive the 12-Year Parts Limited Warranty, online registration must be completed within 60 days of installation. The duration of warranty coverages in Texas differs in some cases.

Additional requirements for annual maintenance are required for the Unit Replacement Limited Warranty. Online registration and some of the additional requirements are not required in California or Québec.

### Standard Features

- » Energy-efficient compressor with internal relief valve
- » Multi-Speed ECM indoor blower motor
- » Quiet horizontal discharge
- » All-aluminum evaporator coil
- » Copper tube / aluminum fin condenser coil
- » Totally enclosed, permanently lubricated condenser fan motor
- » Fully charged R-410A system
- » 5 kW to 20 kW electric heat kit available as a field-installed option
- » Heavy-gauge galvanized-steel cabinet with attractive Nickel Gray powder-paint finish
- » Compressor sound blanket
- » One foot print; 2 heights
- » Aluminum foil-facing internal insulation reinforced with fiberglass scrim
- » Meets cabinet air leakage requirements when tested in accordance with ASHRAE standard 193
- » Fully insulated blower compartment with convenient access panels
- » Louvered condenser coil protection
- » When properly anchored, meets the 2020 Florida Building Code unit integrity requirements for hurricane-type winds (Anchor bracket kits available.)
- » AHRI Certified; ETL listed

The DP3CH packaged home air conditioner is designed for horizontal installation. It comes with an energy-efficient scroll compressor that delivers dependable cooling for lower energy bills compared to lower SEER2 units. Plus, you will be happy to know that your Daikin system uses chlorine-free R-410A refrigerant. Our packaged air conditioner units are also furnished with a variable-speed ECM blower motor that offers silent system startup and shutdown with extremely efficient performance. The heavy-gauge galvanized steel enclosure with a powder-coat finish will shield your system from extreme weather. Supports 2023 DOE Energy Efficiency Standards



Model	Cooling Capacity		SEER2/ EER2	Electric Heat (kW)	Voltage-Phase	MCA	MOP	Dimensions			dBs	Ship Weight (lbs)
	Tons	CFM						W"	D"	H"		
DP3CH2441*	2	875	13.4 / 10.6	5, 8, 10	208/230-1	14.5	20	66	34	22	76	310
DP3CH3041*	2½	1,050	13.4 / 10.6	5, 8, 10, 15	208/230-1	21.6	35	66	34	22	76	315
DP3CH3641*	3	1,200	13.4 / 10.6	5, 8, 10, 15	208/230-1	24.4	35	66	34	22	78	320
DP3CH4241*	3½	1,200	13.4 / 10.6	5, 8, 10, 15, 20	208/230-1	29.2	45	66	34	22	78	374
DP3CH4841*	4	1,600	13.4 / 10.6	5, 8, 10, 15, 20	208/230-1	31.7	50	66	34	24	80	375
DP3CH6041*	5	1,600	13.4 / 10.6	5, 8, 10, 15, 20	208/230-1	35.4	50	66	34	24	80	380

The manufacturing entity reserves the right to discontinue or change at any time specifications or designs without notice or without incurring obligations.

## COMFORTABLE LIMITED WARRANTY\* PROTECTION



\* Complete warranty details available from your local dealer/contractor or at [www.daikincomfort.com](http://www.daikincomfort.com). To receive 6-Year Unit Replacement Limited Warranty and 12-Year Parts Limited Warranty, online registration must be completed within 60 days of installation. The duration of warranty coverages in Texas differs in some cases.

Additional requirements for annual maintenance are required for the Unit Replacement Limited Warranty. Online registration and some of the additional requirements are not required in California or Québec.

## DP5HH

# Packaged Heat Pumps

Up to 15.2 SEER2

### Standard Features

- » High-efficiency scroll compressor
- » Variable-speed ECM blower motor
- » Quiet horizontal discharge
- » All-aluminum evaporator coil
- » Copper tube/aluminum fin coil
- » Totally enclosed, permanently lubricated condenser fan motor
- » Fully charged system
- » Electric heat kit available as a field-installed option
- » AHRI Certified; ETL Listed
- » Heavy-gauge galvanized-steel cabinet
- » UV-resistant grey powder-paint finish
- » Compressor sound blanket
- » Aluminum foil-facing internal insulation reinforced with fiberglass scrim
- » Meets cabinet air leakage requirements when tested in accordance with ASHRAE standard 193
- » Attractive Nickel Gray powder-paint finish
- » Fully insulated blower compartment has convenient access panels
- » Louvered condenser coil protection
- » One footprint; three heights
- » When properly anchored, meets the 2020 Florida Building Code unit integrity requirements for hurricane-type winds (Anchor bracket kits available.)

The DP5HH packaged heat pump has a high-efficiency scroll compressor that provides optimal performance. Two-stage\* heating and cooling, a variable-speed ECM blower motor, and an all-aluminum evaporator coil are only a few of the features that come stock with this 15.2 SEER2 heat pump system. The heavy-gauged galvanized-steel cabinet with nice-looking nickel gray powder-paint finish makes this unit very attractive. Supports 2023 DOE Energy Efficiency Standards.

\*Model specific, please refer to product specifications for more information.



Model	Nominal Ratings			Electric Heat (kW)	SEER2/EER2	Voltage-Phase	MCA	MOP	Dimensions			dBs	Ship Weight (lbs)
	Cooling (BTU/h)	Heating (BTU/h)	Cooling (CFM)						W"	D"	H"		
DP5HH2441**	24,000	24,000	875	5, 8, 10	15.0 / 11.4	208/230-1	21.3	30	66	34	30	76	324
DP5HH3041**	30,000	30,000	1,050	5, 8, 10,15	15.2 / 11.4	208/230-1	22.9	35	66	34	30	76	324
DP5HH3641**	36,000	36,000	1,200	5, 8, 10,15	15.2 / 11.4	208/230-1	23.2	35	66	34	35	78	385
DP5HH4241*	42,000	42,000	1,300	5, 8, 10,15, 20	15.2 / 11.4	208/230-1	30.6	50	66	34	35	79	385
DP5HH4841**	48,000	48,000	1,600	5, 8, 10,15, 20	15.2 / 11.2	208/230-1	34.7	50	66	34	35	78	415
DP5HH6041**	60,000	60,000	1,700	5, 8, 10,15, 20	15.2 / 11.4	208/230-1	40.2	60	66	34	38.5	80	415

The manufacturing entity reserves the right to discontinue or change at any time specifications or designs without notice or without incurring obligations.

UNITARY PRODUCTS

# DP5HM

## Packaged Heat Pump

15.2 SEER2 / 6.8 HSPF

### COMFORTABLE LIMITED WARRANTY\* PROTECTION



\* Complete warranty details available from your local dealer/contractor or at [www.daikincomfort.com](http://www.daikincomfort.com). To receive 6-Year Unit Replacement Limited Warranty and 12-Year Parts Limited Warranty, online registration must be completed within 60 days of installation. The duration of warranty coverages in Texas differs in some cases.

Additional requirements for annual maintenance are required for the Unit Replacement Limited Warranty. Online registration and some of the additional requirements are not required in California or Québec.

### Standard Features

- » Two-stage heating & cooling
- » Energy-efficient two-stage scroll compressor with internal relief valve
- » Multi-speed ECM indoor blower motor
- » Liquid-line filter drier
- » Convertible airflow: horizontal or downflow
- » Copper tube/aluminum fin condenser coils
- » Compressor sound blanket
- » Heavy-gauge galvanized-steel cabinet with attractive two-tone Architectural Gray powder-paint finish
- » Aluminum foil-facing internal insulation reinforced with fiberglass scrim
- » Fully insulated air-handling compartment with convenient access panels
- » Louvered condenser coil protection
- » All-aluminum evaporator coil on 2- to 4-ton units
- » Copper Tube/ Aluminum Fin Evaporator coil (5 Ton)
- » Totally enclosed, permanently lubricated condenser fan motor
- » Electric heat kit available as a field-installed option
- » Compressor grommets for vibration isolation
- » Convenient access panels
- » Compressor sound blanket
- » Bottom, 2" high base rails for easier handling
- » Louvered condenser coil protection
- » When properly anchored, meets the 2020 Florida Building Code unit integrity requirements for hurricane-type winds (Anchor bracket kits available.)
- » AHRI Certified; ETL Listed

The DP5HM packaged heat pump has an energy-efficient compressor that provides optimum performance. Two-stage\* heating and cooling, a variable-speed ECM blower motor, and an aluminum evaporator coil are just a few features that come standard with this 15.2 SEER2 heat pump system. The fully insulated heavy-gauge, zinc-coated steel cabinet with UV-resistant grey powder-paint finish (Sandstone Beige for the 5-ton model) makes this unit very attractive. Supports 2023 DOE Energy Efficiency Standards.

\* Model specific, please refer to product specifications for more information.



Model	Nominal Ratings			Electric Heat (kW)	SEER2/EER2	Voltage-Phase	MCA	MOP	Dimensions			dBs	Ship Weight (lbs)
	Cooling (BTU/h)	Heating (BTU/h)	Cooling (CFM)						W"	D"	H"		
DP5HM2441A*	24,000	24,000	850	5, 8, 10	15.2 / 11.4	208 / 230-1	19.2	30	47	51	34¾	76	376
DP5HM3041A*	30,000	30,000	1050	5, 8, 10, 15	15.2 / 11.4	208 / 230-1	22	35	47	51	34¾	76	385
DP5HM3641A*	36,000	36,000	1200	5, 8, 10, 15	15.2 / 11.4	208 / 230-1	23.3	35	47	51	42¾	81	492
DP5HM4241A*	42,000	42,000	1300	5, 8, 10, 15, 20	15.2 / 11.4	208 / 230-1	33.1	50	47	51	42¾	80	492
DP5HM4841A*	48,000	48,000	1600	5, 8, 10, 15, 20	15.2 / 11.2	208 / 230-1	34.7	50	47	51	42¾	79	492
DP5HM6041A*	60,000	60,000	2000	5, 8, 10, 15, 20	15.2 / 11.2	208 / 230-1	39	60	73 3/8	47 5/8	43½	80	688

The manufacturing entity reserves the right to discontinue or change at any time specifications or designs without notice or without incurring obligations.



COMFORTABLE LIMITED  
WARRANTY\* PROTECTION



\* Complete warranty details available from your local dealer/contractor or at [www.daikincomfort.com](http://www.daikincomfort.com). To receive 12-Year Parts Limited Warranty, online registration must be completed within 60 days of installation. The duration of warranty coverage in Texas differs in some cases.

Additional requirements for annual maintenance are required for the Unit Replacement Limited Warranty. Online registration and some of the additional requirements are not required in California or Québec.

**DP3HH**

Packaged Heat Pump

13.4 SEER2 / 6.70 HSPF2

**Standard Features**

- » Energy-efficient compressor with internal relief valve
- » Multi-speed ECM indoor blower motor
- » Quiet horizontal discharge
- » Copper tube/corrosion-resistant fin
- » Totally enclosed, permanently lubricated condenser fan motor
- » Fully charged system
- » Electric heat kit available as a field-installed option
- » Compressor sound blanket
- » AHRI Certified; ETL listed
- » Heavy-gauge galvanized-steel cabinet with attractive Nickel Gray powder-paint finish
- » Aluminum foil-facing internal insulation reinforced with fiberglass scrim
- » Meets cabinet air leakage requirements when tested in accordance with ASHRAE standard 193
- » Fully insulated blower compartment has convenient access panels
- » Louvered condenser coil protection
- » One footprint; three heights
- » When properly anchored, meets the 2020 Florida Building Code unit integrity requirements for hurricane-type winds (Anchor bracket kits available.)

The Daikin brand DP3HH Energy-Efficient Packaged Heat Pump features energy-efficient cooling and heating performance in one self-contained unit. This unit is housed in a heavy-gauge, galvanized-steel cabinet protected by a high-quality, UV-resistant powder-paint finish. The DP3HH allows for ground-level or rooftop applications. Supports 2023 DOE Energy Efficiency Standards



Model	Nominal Ratings			Electric Heat (kW)	SEER2 / EER	Voltage-Phase	MCA	MOP	Dimensions			dBs	Ship Weight (lbs)
	Cooling (BTU/h)	Heating (BTU/h)	Cooling (CFM)						W"	D"	H"		
DP3HH2441*	24,000	24,000	875	5, 8, 10	13.4 / 10.6	208/230-1	20.8	30	66	34	30	76	324
DP3HH3041*	30,000	30,000	1,050	5, 8, 10, 15	13.4 / 10.6	208/230-1	22.4	35	66	34	30	76	324
DP3HH3641*	36,000	36,000	1,200	5, 8, 10, 15	13.4 / 10.6	208/230-1	26	40	66	34	35	78	387
DP3HH4241*	42,000	42,000	1,300	5, 8, 10, 15, 20	13.4 / 10.6	208/230-1	26.1	40	66	34	35	78	387
DP3HH4841*	48,000	48,000	1,570	5, 8, 10, 15, 20	13.4 / 10.6	208/230-1	31.7	50	66	34	35	80	387
DP3HH6041*	60,000	60,000	1,700	5, 8, 10, 15, 20	13.4 / 10.6	208/230-1	39.8	60	66	34	38½	80	412

The manufacturing entity reserves the right to discontinue or change at any time specifications or designs without notice or without incurring obligations.

UNITARY PRODUCTS

# DP3HM

## Packaged Heat Pump

13.4 SEER2 / 6.7 HSPF2

### COMFORTABLE LIMITED WARRANTY\* PROTECTION



\* Complete warranty details available from your local dealer/contractor or at [www.daikincomfort.com](http://www.daikincomfort.com). To receive the 12-Year Parts Limited Warranty, online registration must be completed within 60 days of installation. Online registration not required in California or Québec. The duration of warranty coverages in Texas differs in some cases. The duration of warranty coverages in Texas differs in some cases.

### Standard Features

- » Energy-efficient compressor with internal relief valve
- » Two-stage cooling on 5-ton units
- » All-aluminum evaporator coil
- » Multi-Speed ECM indoor blower motor
- » Liquid-line filter drier
- » Convertible airflow: horizontal or downflow
- » Copper tube/aluminum fin condenser coils
- » Totally enclosed, permanently lubricated condenser fan motor
- » Electric heat kit available as a field-installed option
- » Heavy-gauge galvanized-steel cabinet with attractive UV-resistant powder-paint finish
- » Fully insulated air-handling compartment with convenient access panels
- » Aluminum foil-facing internal insulation reinforced with fiberglass scrim
- » Compressor sound blanket
- » Louvered condenser coil protection
- » One footprint; two heights
- » AHRI Certified; ETL Listed
- » When properly anchored, meets the 2020 Florida Building Code unit integrity requirements for hurricane-type winds (Anchor bracket kits available.)

The DP3HM packaged heat pump has an energy-efficient compressor that provides optimum performance. single-stage heating and cooling, a multi-speed ECM blower motor, and an aluminum evaporator coil are just a few features that come standard with this 13.4 SEER2 heat pump system. The fully insulated heavy-gauge, zinc-coated steel cabinet with UV-resistant grey powder-paint finish makes this unit very attractive. Supports 2023 DOE Energy Efficiency Standards.



Model	Nominal Ratings			Electric Heat (kW)	SEER2 / EER2	Voltage-Phase	MCA	MOP	Dimensions			dBs	Ship Weight (lbs)
	Cooling (BTU/h)	Heating (BTU/h)	Cooling (CFM)						W"	D"	H"		
DP3HM2441**	24,000	24,000	850	5, 8, 10	13.4 / 10.6	208/230-1	21.4	30	47	51	34¾	76	380
DP3HM3041**	30,000	30,000	1,050	5, 8, 10, 15	13.4 / 10.6	208/230-1	23	35	47	51	34¾	76	390
DP3HM3641**	36,000	36,000	1,200	5, 8, 10, 15	13.4 / 10.6	208/230-1	24.4	35	47	51	42¾	81	400
DP14HM4241**	48,000	48,000	1,300	5, 8, 10, 15	13.4 / 10.6	208/230-1	29.2	45	47	51	42¾	80	485
DP14HM4841**	60,000	60,000	1,600	5, 8, 10, 15, 20	13.4 / 10.6	208/230-1	31.9	50	47	51	42¾	79	495
DP14HM6041A*	60,000	60,000	1,850	5, 8, 10, 15, 20	13.4 / 10.6	208/230-1	37.5	60	73¾	47¾	43½	80	495

<sup>1</sup>Tons

The manufacturing entity reserves the right to discontinue or change at any time specifications or designs without notice or without incurring obligations.



\* Complete warranty details available from your local dealer/contractor or at [www.daikincomfort.com](http://www.daikincomfort.com). To receive the Lifetime Heat Exchanger Limited Warranty (good for as long as you own your home), 6-Year Unit Replacement Limited Warranty and 12-Year Parts Limited Warranty, online registration must be completed within 60 days of installation. The duration of warranty coverages in Texas differs in some cases.

Additional requirements for annual maintenance are required for the Unit Replacement Limited Warranty. Online registration and some of the additional requirements are not required in California or Québec.

# Packaged Gas & Electric

Up to 15.2 SEER2 / 8.0 HSPF

## Standard Features

- » Heavy-duty stainless-steel heat exchanger
- » High-efficiency two-stage scroll compressor with factory-installed sound blanket
- » Multi-speed ECM indoor blower motor
- » Copper tube/aluminum fin evaporator coil (5 Ton)
- » All-aluminum evaporator coil (2-4 Ton)
- » Two-stage gas valve; natural gas with easy conversion to propane
- » Power-assisted combustion
- » All blower operation and all safety circuits complete with self-diagnostics
- » Loss-of-charge protection and high-pressure switch
- » Direct-spark ignition system with microprocessor-based control for the entire ignition sequence
- » Can not be installed in California's South Coast Air Quality Management District (SCAQMD) and San Joaquin Valley Air Pollution Control District (SJVAPCD).
- » All models comply with California Low NOx standards.
- » AHRI Certified; ETL Listed
- » Fully insulated heavy-gauge, zinc-coated steel cabinet with UV-resistant grey powder-paint finish (Sandstone Beige for the 5-ton model)
- » Aluminum foil-facing internal insulation reinforced with fiberglass scrim
- » Louvered condenser coil protection
- » Compressor sound blanket
- » Compressor grommets for vibration isolation
- » Horizontal or downflow application
- » Convenient access panels
- » Bottom 2" high base rails for easier handling
- » When properly anchored, meets the 2020 Florida Building Code unit integrity requirements for hurricane-type winds (Anchor bracket kits available.)

The DP5GM gas/electric packaged unit has an energy-efficient compressor that provides optimum performance. Two-stage heating and cooling, a variable-speed ECM blower motor, and an aluminum evaporator coil are just a few features that come standard with this 15.2 SEER2 gas/electric packaged unit. The fully insulated heavy-gauge, zinc-coated steel cabinet with UV-resistant grey powder-paint finish (Sandstone Beige for the 5-ton model) makes this unit very attractive. Supports 2023 DOE Energy Efficiency Standards.



5 Tons

2 - 4 Tons



Model	Nominal Ratings			SEER2 / EER2	Voltage-Phase	MCA	MOP	Dimensions			DBs	Ship Weight (lbs)
	Cooling <sup>1</sup>	Heating <sup>2</sup>	Cooling <sup>3</sup>					W"	D"	H"		
DP5GM2406041A*	24,000	60,000	800	15.2 / 11.2	208/230-1	18.4	25	47	51	34½	77	380
DP5GM3008041A*	30,000	80,000	950	14.6 / 11.2	208/230-1	22.0	35	47	51	34½	76	407
DP5GM3608041A*	36,000	80,000	1,200	15.2 / 11.2	208/230-1	25.8	35	47	51	42½	78	480
DP5GM4210041A*	42,000	100,000	1,250	14.7 / 11.2	208/230-1	33.1	50	47	51	42½	79	505
DP5GM4810041A*	48,000	100,000	1,300	15.0 / 11.2	208/230-1	33.7	50	47	51	42½	78	500
DP5GM6014041A*	60,000	140,000	2,000	15.2 / 11.2	208/230-1	43.3	70	73%	47%	43½	78	655

<sup>1</sup> BTU/h    <sup>2</sup> BTU/h    <sup>3</sup> CFM

The manufacturing entity reserves the right to discontinue or change at any time specifications or designs without notice or without incurring obligations.

UNITARY PRODUCTS

# DP5UM

## Packaged Gas & Electric

Up to 15.2 SEER2 / 81% AFUE

### COMFORTABLE LIMITED WARRANTY\* PROTECTION



\* Complete warranty details available from your local dealer/contractor or at [www.daikincomfort.com](http://www.daikincomfort.com). To receive the Lifetime Heat Exchanger Limited Warranty (good for as long as you own your home), 6-Year Unit Replacement Limited Warranty and 12-Year Parts Limited Warranty, online registration must be completed within 60 days of installation. The duration of warranty coverages in Texas differs in some cases.

Additional requirements for annual maintenance are required for the Unit Replacement Limited Warranty. Online registration and some of the additional requirements are not required in California or Québec.

### Standard Features

- » Heavy-duty stainless-steel heat exchanger
- » High-efficiency two-stage scroll compressor with factory-installed sound blanket
- » Multi-speed ECM indoor blower motor
- » All-aluminum evaporator coil
- » TXV expansion device
- » Single-stage gas valve
- » Power-assisted combustion
- » All blower operation and all safety circuits complete with self-diagnostics
- » Loss-of-charge protection and high-pressure switch
- » Direct-spark ignition system with microprocessor-based control for the entire ignition sequence
- » All Ultra-Low NOx DP5UM models comply with the 14 ng/J emission limit specified in the South Coast Air Quality Management District (SCAQMD) Rule 1111 and San Joaquin Valley Air Pollution Control District (SJVAPCD) Rule 4905. Learn more at [www.aqmd.gov](http://www.aqmd.gov) and [www.valleyair.org](http://www.valleyair.org).
- » AHRI Certified
- » ETL Listed
- » Fully insulated heavy-gauge, zinc-coated steel cabinet with UV-resistant grey powder-paint finish
- » Aluminum foil-facing internal insulation reinforced with fiberglass scrim
- » Louvered condenser coil protection
- » Compressor sound blanket
- » Compressor grommets for vibration isolation
- » Horizontal or downflow application
- » Convenient access panels
- » Bottom 2" high base rails for easier handling
- » When properly anchored, meets the 2020 Florida Building Code unit integrity requirements for hurricane-type winds (Anchor bracket kits available.)

The DP5UM Ultra-Low NOx gas/electric packaged air conditioner unit has an energy-efficient compressor that provides optimum performance. One-stage heating and two-stage cooling, it comes with factory-installed compressor sound blanket that provides great noise dampening. Heavy-duty stainless-steel heat exchanger, all-aluminum evaporator coil, and multi-speed ECM blower motor are just a few features that come stock with this 15.2 SEER2 gas / electric HVAC unit. The fully insulated heavy-gauge, zinc-coated steel cabinet with UV-resistant grey powder-paint finish makes this unit very attractive. Supports 2023 DOE Energy Efficiency Standards.



Model	Nominal Ratings			SEER2 / EER	Voltage-Phase	MCA	MOP	Dimensions			dBs	Ship Weight (lbs)
	Cooling <sup>1</sup>	Gas Heating <sup>2</sup>	CFM					W"	D"	H"		
DP5UM3008041A*	30,000	80,000	950	14.6 / 11.2	208/230-1	22.0	35	47	51	34½	76	407
DP5UM3608041A*	36,000	80,000	1180	15.2 / 11.2	208/230-1	25.8	35	47	51	42½	78	500

<sup>1</sup> BTU/h <sup>2</sup> BTU/h

The manufacturing entity reserves the right to discontinue or change at any time specifications or designs without notice or without incurring obligations.



COMFORTABLE LIMITED WARRANTY\* PROTECTION



\* Complete warranty details available from your local dealer/contractor or at [www.daikincomfort.com](http://www.daikincomfort.com). To receive the Lifetime Heat Exchanger Limited Warranty (good for as long as you own your home), 12-Year Parts Limited Warranty, online registration must be completed within 60 days of installation. The duration of warranty coverages in Texas differs in some cases.

Additional requirements for annual maintenance are required for the Unit Replacement Limited Warranty. Online registration and some of the additional requirements are not required in California or Québec.

DP3GM

Packaged Gas & Electric  
Up to 13.4 SEER2

Standard Features

- » Heavy-duty stainless-steel heat exchanger
- » Energy-efficient compressor
- » All-aluminum evaporator coil
- » Flowrater expansion device on 2- to 4-ton units
- » TXV expansion device on 5-ton units
- » Multi-speed ECM blower motor
- » Redundant gas valve with easy conversion to propane
- » Power-assisted combustion
- » Direct spark ignition system includes a microprocessor-based control for the entire ignition sequence, all blower operation, and all safety circuits complete with self-diagnostics
- » Can not be installed in California's South Coast Air Quality Management District (SCAQMD) and San Joaquin Valley Air Pollution Control District (SJVAPCD).
- » All models comply with California Low NOx standards.
- » AHRI Certified; ETL Listed
- » Fully insulated heavy-gauge, zinc-coated steel cabinet with UV-resistant powder-paint finish
- » Horizontal or downflow application
- » Aluminum foil-facing internal insulation reinforced with fiberglass scrim
- » Compressor sound blanket
- » Convenient access panels
- » One roof curb fits all units
- » One foot print: two heights

The DP3GM gas/electric packaged air conditioner offers energy-efficient cooling and heating performance in one self-contained unit. It comes with factory-installed compressor sound blanket that provides great noise dampening. Heavy-duty stainless-steel heat exchanger, all-aluminum evaporator coil, and multi-speed ECM blower motor are just a few features that come stock with this 13.4 SEER2 gas / electric HVAC unit. The fully insulated heavy-gauge, zinc-coated steel cabinet with UV-resistant grey powder-paint finish makes this unit very attractive. Supports 2023 DOE Energy Efficiency Standards.



- » Bottom, 2" high base rails for easier handling
- » One footprint; two heights
- » When properly anchored, meets the 2020 Florida Building Code unit integrity requirements for hurricane-type winds (Anchor bracket kits available.)

Model	Nominal Ratings			SEER2 / EER2	Voltage-Phase	MCA	MOP	Dimensions			DBs	Ship Weight (lbs)
	Cooling (BTU/h)	Heating (BTU/h)	CFM					W"	D"	H"		
DP3GM2404041	24,000	40,000	800	13.4 / 10.6	208/230-1	21.6	35	47	51	34½	78	435
DP3GM2406041	24,000	60,000	800	13.4 / 10.6	208/230-1	21.6	35	47	51	34½	78	439
DP3GM3004041	30,000	40,000	1,000	13.4 / 10.6	208/230-1	22.8	35	47	51	34½	78	438
DP3GM3006041	30,000	60,000	1,000	13.4 / 10.6	208/230-1	22.8	35	47	51	34½	78	442
DP3GM3604041	36,000	40,000	1,200	13.4 / 10.6	208/230-1	22.8	35	47	51	34½	78	470
DP3GM3606041	36,000	60,000	1,200	13.4 / 10.6	208/230-1	22.8	35	47	51	34½	78	475
DP3GM3608041	36,000	80,000	1,200	13.4 / 10.6	208/230-1	22.8	35	47	51	34½	78	480
DP3GM4206041	42,000	60,000	1,300	13.4 / 10.6	208/230-1	29.2	45	47	51	34½	78	515
DP3GM4208041	42,000	80,000	1,300	13.4 / 10.6	208/230-1	29.2	45	47	51	34½	78	520
DP3GM4806041	48,000	60,000	1,525	13.4 / 10.6	208/230-1	32.3	50	47	51	42½	79	540
DP3GM4808041	48,000	80,000	1,525	13.4 / 10.6	208/230-1	32.3	50	47	51	42½	79	545
DP3GM4810041	48,000	100,000	1,525	13.4 / 10.6	208/230-1	32.3	50	47	51	42½	79	550
DP3GM6108041	60,000	80,000	1,750	13.4 / 10.6	208/230-1	41.0	60	47	51	42½	78	555
DP3GM6110041	60,000	100,000	1,750	13.4 / 10.6	208/230-1	41.0	60	47	51	42½	78	560
DP3GM6112041	60,000	120,000	1,750	13.4 / 10.6	208/230-1	41.0	60	47	51	42½	78	565

The manufacturing entity reserves the right to discontinue or change at any time specifications or designs without notice or without incurring obligations.

UNITARY PRODUCTS

# DP3UM

## Packaged Gas & Electric Ultra-Low NO<sub>x</sub>

Up to 13.4 SEER2 / 81% AFUE

COMFORTABLE LIMITED WARRANTY\* PROTECTION



\* Complete warranty details available from your local dealer/contractor or at [www.daikincomfort.com](http://www.daikincomfort.com). To receive the Lifetime Heat Exchanger Limited Warranty (good for as long as you own your home), 12-Year Parts Limited Warranty, online registration must be completed within 60 days of installation. The duration of warranty coverages in Texas differs in some cases.

Additional requirements for annual maintenance are required for the Unit Replacement Limited Warranty. Online registration and some of the additional requirements are not required in California or Québec.

### Standard Features

- » Heavy-duty stainless-steel heat exchanger
- » Energy-efficient scroll compressor
- » Multi-Speed ECM indoor blower motor
- » Single-stage gas valve
- » All-aluminum evaporator coil
- » Flowrater expansion device on 2- to 4-ton units
- » TXV expansion device on 5-ton units
- » Power-assisted combustion
- » Direct spark ignition system includes a microprocessor-based control for the entire ignition sequence, all blower operation, and all safety circuits complete with self-diagnostics
- » All Ultra-Low NO<sub>x</sub> DP3UM models comply with the 14 ng/J emission limit specified in the South Coast Air Quality Management District (SCAQMD) Rule 1111 and San Joaquin Valley Air Pollution Control District (SJVAPCD) Rule 4905. Learn more at [www.aqmd.gov](http://www.aqmd.gov) and [www.valleyair.org](http://www.valleyair.org).
- » AHRI Certified
- » ETL Listed
- » Fully insulated heavy-gauge, zinc-coated steel cabinet with UV-resistant powder-paint finish
- » Horizontal or downflow application
- » Aluminum foil-facing internal insulation reinforced with fiberglass scrim
- » Compressor sound blanket
- » Convenient access panels
- » One roof curb fits all units
- » One foot print: two heights
- » Bottom, 2" high base rails for easier handling
- » One footprint; two heights
- » When properly anchored, meets the 2020 Florida Building Code unit integrity requirements for hurricane-type winds (Anchor bracket kits available.)

The DP3UM Ultra-Low NO<sub>x</sub> gas/electric packaged air conditioner offers energy-efficient cooling and heating performance in one self-contained unit. It comes with a factory-installed compressor sound blanket that provides great noise dampening. Heavy-duty stainless-steel heat exchanger, all-aluminum evaporator coil, and multi-speed ECM blower motor are just a few features that come stock with this 13.4 SEER2 gas / electric HVAC unit. The fully insulated heavy-gauge, zinc-coated steel cabinet with UV-resistant grey powder-paint finish makes this unit very attractive. Supports 2023 DOE Energy Efficiency Standards.



Model	Nominal Ratings			SEER2 / EER2	Voltage-Phase	MCA	MOP	Dimensions			dBs	Ship Weight (lbs)
	Cooling (BTU/h)	Heating (BTU/h)	CFM					W"	D"	H"		
DP3UM2404041	24,000	40,000	800	13.4 / 10.6	208/230-1	21.6	35	47	51	34½	78	435
DP3UM3006041	30,000	60,000	1,000	13.4 / 10.6	208/230-1	22.8	35	47	51	34½	78	442
DP3UM3606041	36,000	60,000	1,200	13.4 / 10.6	208/230-1	22.8	35	47	51	34½	78	520
DP3UM4208041	42,000	80,000	1,300	13.4 / 10.6	208/230-1	29.2	45	47	51	42½	78	545
DP3UM4808041	48,000	80,000	1,525	13.4 / 10.6	208/230-1	32.3	50	47	51	42½	79	555
DP3UM6108041	60,000	80,000	1,700	13.4 / 10.6	208/230-1	41	60	47	51	42½	78	555

The manufacturing entity reserves the right to discontinue or change at any time specifications or designs without notice or without incurring obligations.

COMFORTABLE LIMITED WARRANTY\* PROTECTION



\* Complete warranty details available from your local dealer/contractor or at [www.daikincomfort.com](http://www.daikincomfort.com). To receive the Lifetime Heat Exchanger Limited Warranty (good for as long as you own your home), 6-Year Unit Replacement Limited Warranty and 12-Year Parts Limited Warranty, online registration must be completed within 60 days of installation. The duration of warranty coverages in Texas differs in some cases.

Additional requirements for annual maintenance are required for the Unit Replacement Limited Warranty. Online registration and some of the additional requirements are not required in California or Québec.

DP3DM

Packaged Dual-Fuel

13.4 SEER2 / 80% AFUE

Standard Features

- » Combines cooling with heat pump and gas heating for optimal year-long performance
- » High-efficiency scroll compressor
- » Heavy-duty stainless-steel tubular heat exchanger
- » Multi-Speed ECM indoor blower motor
- » All-aluminum evaporator coil
- » Copper tube / aluminum fin coil
- » Two-stage gas valve; natural gas with easy conversion to propane with accessory kit
- » Power-assisted combustion
- » Loss-of-charge protection
- » Direct spark ignition system with a microprocessor-based control for the entire ignition sequence
- » All blower operation and all safety circuits complete with self-diagnostics
- » Can not be installed in California's South Coast Air Quality Management District (SCAQMD) and San Joaquin Valley Air Pollution Control District (SJVAPCD).
- » All models comply with California Low NOx standards.
- » AHRI Certified; ETL Listed
- » Fully insulated heavy-gauge, zinc-coated steel cabinet with UV-resistant powder-paint finish
- » Compressor sound blanket
- » Louvered metal panel condenser coil protection
- » Aluminum foil-facing internal insulation reinforced with fiberglass scrim
- » Horizontal or downflow application
- » Convenient access panels
- » One roof curb fits all units
- » Bottom, 2" high base rails for easy handling
- » All models fit a standard-size pick-up truck
- » When properly anchored, meets the 2020 Florida Building Code unit integrity requirements for hurricane-type winds (Anchor bracket kits available.)

The Daikin Brand DP3DM High-Efficiency Packaged Dual-Fuel unit provides indoor comfort and energy-efficient cooling with heat pump and gas heating for optimal year-long performance in one self-contained unit. It comes with a factory-installed compressor sound blanket that provides great noise dampening. Heavy-duty stainless-steel heat exchanger, all-aluminum evaporator coil, and multi-speed ECM blower motor are just a few features that come stock with this 13.4 SEER2 Dual-Fuel HVAC unit. The fully insulated heavy-gauge, zinc-coated steel cabinet with UV-resistant grey powder-paint finish makes this unit very attractive. Supports 2023 DOE Energy Efficiency Standards.



Model	Nominal Capacities (BTU/h)			SEER2 / EER2	Voltage-Phase	MCA	MOP	Dimensions			DBs	Ship Weight (lbs)
	Cooling	Heating	Gas Heat					W"	D"	H"		
DP3DM2406041	24,000	24,000	60,000	13.4 / 10.6	208-230/ 1/ 61	20.8	30	47	51	34½	76	440
DP3DM3008041	30,000	30,000	80,000	13.4 / 10.6	208-230/ 1/ 61	22.7	35	47	51	34½	76	440
DP3DM3608041	36,000	36,000	80,000	13.4 / 10.6	208-230/ 1/ 61	25.1	40	47	51	34½	76	460
DP3DM4210041	42,000	42,000	100,000	13.4 / 10.6	208-230/ 1/ 61	29.2	45	47	51	42½	76	545
DP3DM4810041	48,000	48,000	100,000	13.4 / 10.6	208-230/ 1/ 61	31.7	50	47	51	42½	76	545

The manufacturing entity reserves the right to discontinue or change at any time specifications or designs without notice or without incurring obligations.

UNITARY PRODUCTS









PROTECT THEIR INVESTMENT FOR YEARS TO COME.  
ASURE<sup>SM</sup> EXTENDED SERVICE PLAN



Daikin brand equipment is optimized to provide premium comfort through the latest innovations. However, any mechanical product occasionally fails. As an authorized Asure dealer, you can offer your customer extended service agreements as a safeguard from those occasional failures.

**The Asure<sup>SM</sup> program provides your business with the following benefits:**

- » Adds value to homeowner's purchase. Provides the homeowner peace-of-mind that they have protected their investment and guaranteed their comfort system for the terms of their agreement against unplanned repair bills.
- » Builds your customer base. By providing your customer with worry-free comfort, you earn your customer's loyalty and confidence, along with that of their friends and neighbors. What better way is there to grow your business?

**What is covered?**

Asure provides coverage on all functional parts of Daikin brand 3/4-through-5 ton, single-phase ductless HVAC products. Coverage may be offered on equipment that has been installed within the last year. Routine maintenance and the cost to correct failures other than those considered to be manufacturing defects are excluded from coverage. For more information, please visit [www.daikincomfort.com](http://www.daikincomfort.com).

### About Daikin:

Daikin Industries, Ltd. (DIL) is a global Fortune 1000 company and is recognized as one of the largest HVAC (Heating, Ventilation, Air Conditioning) manufacturers in the world. Founded in 1924, Daikin is approaching 100 years of HVAC worldwide leadership. DIL is primarily engaged in developing indoor comfort systems and refrigeration products for residential, commercial, and industrial applications. Its consistent success is derived, in part, from a focus on innovative, energy-efficient, and premium quality indoor climate and comfort management solutions.

### Additional Information

Before purchasing this appliance, read important information about its estimated annual energy consumption, yearly operating cost, or energy efficiency rating that is available from your retailer.



Our continuing commitment to quality products may mean a change in specifications without notice.

© 2023 **DAIKIN COMFORT TECHNOLOGIES NORTH AMERICA, INC.**

Houston, Texas · USA · [www.daikincomfort.com](http://www.daikincomfort.com) or [www.daikinac.com](http://www.daikinac.com)