

Project name:	
Location:	Approval:
Engineer:	Date:
Submitted to:	Construction:
Submitted by:	Unit #:
Reference:	Drawing #:

DESCRIPTION

The DZK increases the flexibility of Daikin VRV and Sky Air systems by adding a zoning damper box for independent zone temperature control from a single indoor unit.

Model	DZKS048E4-4
Description	Daikin Zoning Kit
Damper Control	Flow Control System by Airzone
Damper Size	8"
Number of Dampers	4
Insulation Value	R4
Operating range	32 to 122°F (0 to 50°C) 5% to 90% RH (non-condensing)
Weight (Mass)	9.6 kg - 21.16 lb
Power supply	110/230VAC, 1Ø, 50/60Hz, 250mA
Size (WxHxD)	53.43x10.43x10.43 inch (1357.3x265x265 mm)
Compatible Indoor Units	FXSQ 36-48 TAVJU FXSQ 36-48 TBVJU FXMQ 30-36-48 TBVJU

FEATURES

- Each zone is capable of:
 - Independent set point control.
 - Set point range limitation.
 - Local ventilation mode.
 - Adjustable min/max zone opening position.
- Option to link multiple outlets for larger zones.
- Option to cap and close unused outlets.
- Auto changeover logic including adjustable zone weighting.
- Automatic control of fan speed based on each damper's demand.
- Direct control integration to the Daikin indoor unit through the P1/P2 protocol.
- Pre-assembled plenum box and simple bolt on design saves installation time.
- Centralized zone control and monitoring when using DZK-BACNET-HUB-4.

AVAILABLE DZK-4 THERMOSTATS

- DZK-MTS-4-W – Wired Thermostat (minimum one Wired Thermostat required)
- DZK-ZTS-4-W – Wireless Thermostat
- DZK-LTS-4-W – Wireless Lite Thermostat
- DZK-BACNET-HUB-4 – BACNET Interface



DZKS048E4-4



DZK-MTS-4-W

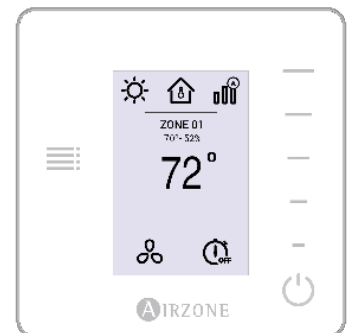

DZK-ZTS-4-W



DZK-LTS-4-W

Project name:	
Location:	Approval:
Engineer:	Date:
Submitted to:	Construction:
Submitted by:	Unit #:
Reference:	Drawing #:

DIMENSIONAL DRAWING (UNITS INCH)

DZKS048E4-4

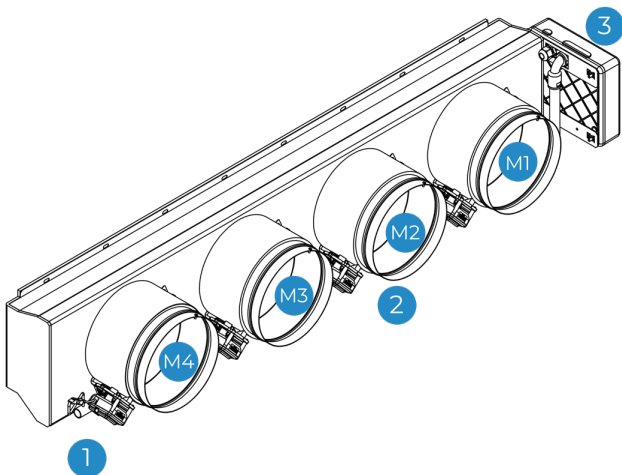
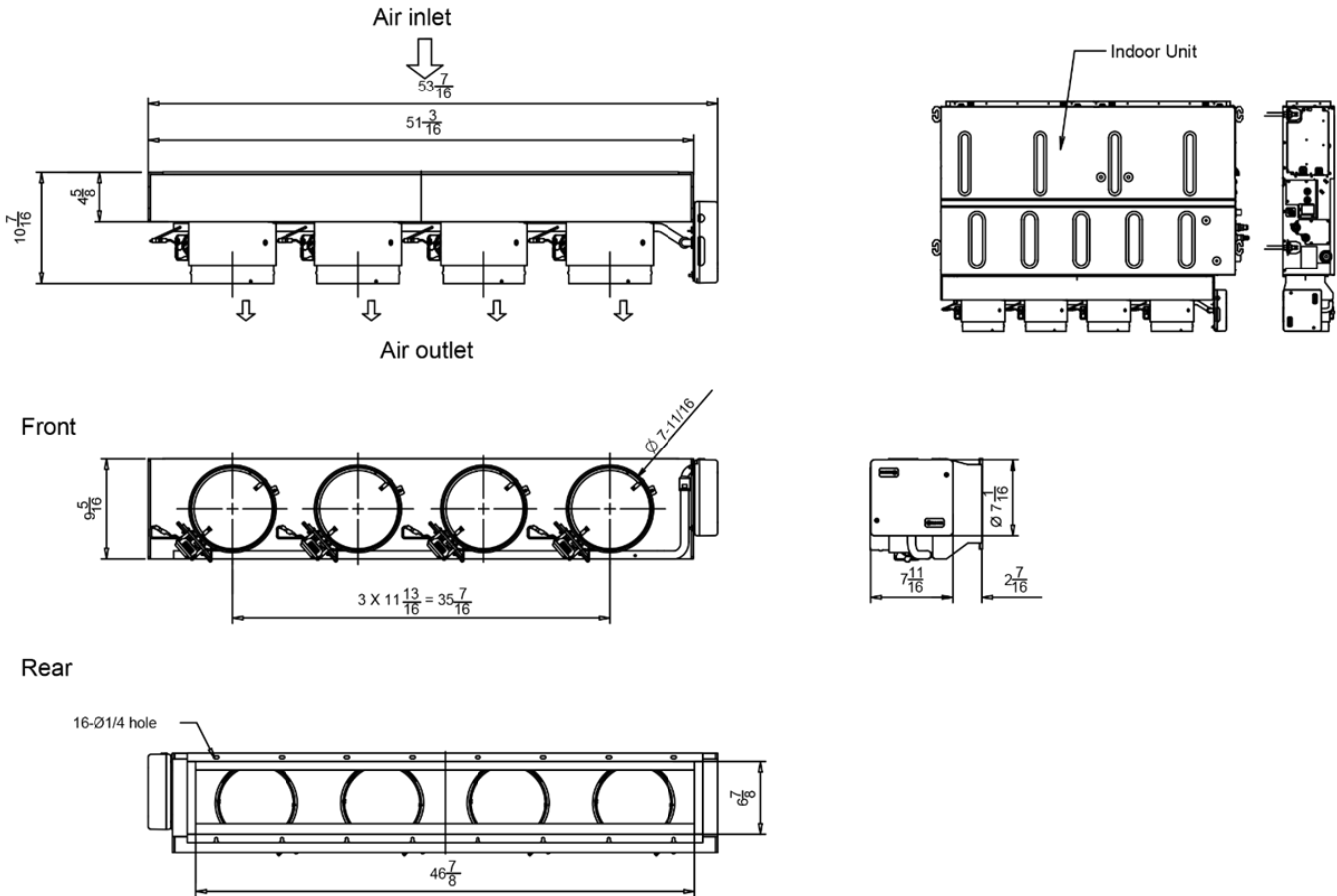

Model	
1	Actuator
2	Damper
3	Main control board
MX	Damper number (X)

Note: Dampers are numbered starting with number 1 next to the Zoning box control board.