



SiUS042113E

R-32

Service Manual

Inverter Pair Wall Mounted Type FTXM-V Series

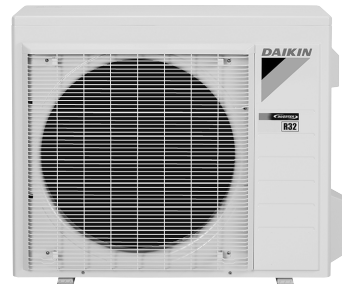
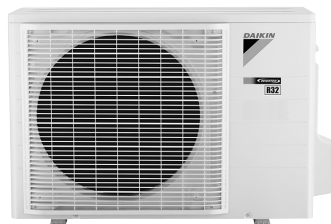

[Applied Models]
● Inverter Pair : Heat Pump

Introduction	1
1. Safety Cautions	2
1.1 Warnings and Cautions Regarding Safety of Workers	2
1.2 Warnings and Cautions Regarding Safety of Users	4
2. Icons Used	7
3. Revision History	8
 Part 1 General Information	 9
1. Applicable Models	10
2. Functions	11
 Part 2 Specifications	 12
1. Specifications	13
 Part 3 Printed Circuit Board Connector Wiring Diagram	 15
1. Indoor Unit	16
2. Outdoor Unit	20
2.1 09/12 class	20
2.2 18/24 class	21
 Part 4 Functions and Control	 23
1. Main Functions	24
1.1 Temperature Control	24
1.2 Frequency Principle	24
1.3 Airflow Direction Control	26
1.4 COMFORT AIRFLOW Operation	27
1.5 Fan Speed Control for Indoor Unit	29
1.6 Hybrid Cooling	30
1.7 Automatic Cooling/Heating Changeover	33
1.8 Thermostat Control	34
1.9 NIGHT SET Mode	35
1.10 ECONO Operation	35
1.11 2-Area INTELLIGENT EYE Operation	36
1.12 INTELLIGENT EYE Operation	40
1.13 POWERFUL Operation	42
1.14 Clock Setting	43
1.15 WEEKLY TIMER Operation	44
1.16 Brightness Setting of Indoor Unit Display	50
1.17 CLEAN Operation	51
1.18 Wireless LAN Connection	53
1.19 Other Functions	58
2. Thermistor Functions	59
3. Control Specification	61
3.1 Mode Hierarchy	61

3.2	Frequency Control.....	61
3.3	Standby Electricity Saving (Suspend Function)	63
3.4	Controls at Mode Changing/Start-up.....	64
3.5	Discharge Pipe Temperature Control.....	66
3.6	Input Current Control.....	67
3.7	Freeze-up Protection Control	68
3.8	Heating Peak-cut Control	68
3.9	High Pressure Protection Control.....	69
3.10	Outdoor Fan Control.....	70
3.11	Liquid Compression Protection Function.....	70
3.12	Defrost Control	71
3.13	Electronic Expansion Valve Control	72
3.14	Malfunctions	75

Part 5 Remote Controller 76

1.	Applicable Remote Controller	77
2.	ARC466A70	78
3.	ARC466A71	80

Part 6 Service Diagnosis 82

1.	General Problem Symptoms and Check Items	84
2.	Troubleshooting with LED	85
2.1	Indoor Unit.....	85
2.2	Outdoor Unit.....	85
3.	Service Diagnosis	86
3.1	Method 1	86
3.2	Method 2	87
4.	Troubleshooting	89
4.1	Error Codes and Description	89
4.2	Indoor Unit PCB Abnormality	90
4.3	Freeze-up Protection Control/Heating Peak-cut Control	91
4.4	Indoor Fan Motor (DC Motor) or Related Abnormality	93
4.5	Thermistor or Related Abnormality.....	95
4.6	Humidity Sensor Abnormality	96
4.7	Refrigerant Shortage	97
4.8	Low-voltage Detection or Over-voltage Detection.....	99
4.9	Signal Transmission Error (Between Indoor Unit and Outdoor Unit).....	101
4.10	Unspecified Voltage (Between Indoor Unit and Outdoor Unit)	103
4.11	Outdoor Unit PCB Abnormality.....	104
4.12	Actuation of High Pressure Switch	105
4.13	OL Activation (Compressor Overload)	106
4.14	Compressor Lock	109
4.15	DC Fan Lock	110
4.16	Input Overcurrent Detection	111
4.17	Four Way Valve Abnormality.....	113
4.18	Discharge Pipe Temperature Control.....	115
4.19	High Pressure Control in Cooling	117

4.20	System Shutdown due to Temperature Abnormality in Compressor	119
4.21	Compressor System Sensor Abnormality	120
4.22	Position Sensor Abnormality	121
4.23	DC Voltage/Current Sensor Abnormality.....	124
4.24	Thermistor or Related Abnormality (Outdoor Unit).....	126
4.25	Electrical Box Temperature Rise	128
4.26	Radiation Fin Temperature Rise	129
4.27	Output Overcurrent Detection	131
5.	Check	134
5.1	Thermistor Resistance Check	134
5.2	Indoor Fan Motor Connector Check	135
5.3	Power Supply Waveform Check.....	135
5.4	Electronic Expansion Valve Check.....	136
5.5	Four Way Valve Performance Check	137
5.6	Inverter Unit Refrigerant System Check.....	138
5.7	Inverter Analyzer Check	138
5.8	Rotation Pulse Check on the Outdoor Unit PCB.....	140
5.9	Installation Condition Check.....	141
5.10	Discharge Pressure Check.....	142
5.11	Outdoor Fan System Check.....	142
5.12	Main Circuit Short Check.....	142
5.13	Capacitor Voltage Check.....	144
5.14	Power Module Check	145

Part 7 Trial Operation and Field Settings 147

1.	Pump Down Operation.....	148
2.	Forced Cooling Operation	149
3.	Trial Operation	150
4.	Field Settings	152
4.1	Temperature Display Switch	152
4.2	When 2 Units are Installed in 1 Room.....	152
4.3	Facility Setting (cooling at low outdoor temperature)	153
4.4	Drain Pan Heater.....	154
4.5	Service Mode of Wireless Remote Controller	155
5.	Silicone Grease on Power Transistor/Diode Bridge.....	158

Part 8 Appendix 159



1.	Piping Diagrams.....	160
1.1	Indoor Unit.....	160
1.2	Outdoor Unit.....	161
2.	Wiring Diagrams.....	163
2.1	Indoor Unit.....	163
2.2	Outdoor Unit.....	165
3.	Operation Limit.....	167

Introduction

1. Safety Cautions	2
1.1 Warnings and Cautions Regarding Safety of Workers	2
1.2 Warnings and Cautions Regarding Safety of Users	4
2. Icons Used	7
3. Revision History	8

1. Safety Cautions

Be sure to read the following safety cautions before conducting repair work. After the repair work is complete, be sure to conduct a test operation to ensure that the equipment operates normally, and explain the cautions for operating the product to the customer.

	This manual is for the person in charge of maintenance and inspection.	 A2L	This appliance is filled with R-32.
---	--	--	-------------------------------------







Caution Items







The caution items are classified into **Warning** and **Caution**. The **Warning** items are especially important since death or serious injury can result if they are not followed closely. The **Caution** items can also lead to serious accidents under some conditions if they are not followed. Therefore, be sure to observe all the safety caution items described below.







Pictograms



- △ This symbol indicates an item for which caution must be exercised. The pictogram shows the item to which attention must be paid.
- This symbol indicates a prohibited action. The prohibited item or action is shown in the illustration or near the symbol.
- This symbol indicates an action that must be taken, or an instruction. The instruction is shown in the illustration or near the symbol.

1.1 Warnings and Cautions Regarding Safety of Workers









 Warning	
<p>Do not store equipment in a room with fire sources (e.g., naked flames, gas appliances, electric heaters).</p>	
<p>Be sure to disconnect the power cable from the socket before disassembling equipment for repair. Working on equipment that is connected to the power supply may cause an electrical shock. If it is necessary to supply power to the equipment to conduct the repair or inspect the circuits, do not touch any electrically charged sections of the equipment.</p>	
<p>If refrigerant gas is discharged during repair work, do not touch the discharged refrigerant gas. Refrigerant gas may cause frostbite.</p>	
<p>When disconnecting the suction or discharge pipe of the compressor at the welded section, evacuate the refrigerant gas completely at a well-ventilated place first. If there is gas remaining inside the compressor, the refrigerant gas or refrigerating machine oil discharges when the pipe is disconnected, and it may cause injury.</p>	
<p>If refrigerant gas leaks during repair work, ventilate the area. Refrigerant gas may generate toxic gases when it contacts flames.</p>	







 Warning	
<p>Be sure to discharge the capacitor completely before conducting repair work. The step-up capacitor supplies high-voltage electricity to the electrical components of the outdoor unit. A charged capacitor may cause an electrical shock.</p>	
<p>Do not turn the air conditioner on or off by plugging in or unplugging the power cable. Plugging in or unplugging the power cable to operate the equipment may cause an electrical shock or fire.</p>	
<p>Be sure to wear a safety helmet, gloves, and a safety belt when working in a high place (more than 2 m (6.5 ft)). Insufficient safety measures may cause a fall.</p>	
<p>In case of R-32 / R-410A refrigerant models, be sure to use pipes, flare nuts and tools intended for the exclusive use with the R-32 / R-410A refrigerant. The use of materials for R-22 refrigerant models may cause a serious accident, such as a damage of refrigerant cycle or equipment failure.</p>	
<p>Do not mix air or gas other than the specified refrigerant (R-32 / R-410A / R-22) in the refrigerant system. If air enters the refrigerant system, an excessively high pressure results, causing equipment damage and injury.</p>	







 Caution	
<p>Do not repair electrical components with wet hands. Working on the equipment with wet hands may cause an electrical shock.</p>	
<p>Do not clean the air conditioner with water. Washing the unit with water may cause an electrical shock.</p>	
<p>Be sure to provide an earth / grounding when repairing the equipment in a humid or wet place, to avoid electrical shocks.</p>	
<p>Be sure to turn off the power switch and unplug the power cable when cleaning the equipment. The internal fan rotates at a high speed, and may cause injury.</p>	
<p>Be sure to conduct repair work with appropriate tools. The use of inappropriate tools may cause injury.</p>	





 Caution	
<p>Be sure to check that the refrigerating cycle section has cooled down enough before conducting repair work. Working on the unit when the refrigerating cycle section is hot may cause burns.</p>	
<p>Conduct welding work in a well-ventilated place. Using the welder in an enclosed room may cause oxygen deficiency.</p>	

1.2 Warnings and Cautions Regarding Safety of Users

 Warning	
<p>Do not store the equipment in a room with fire sources (e.g., naked flames, gas appliances, electric heaters).</p>	
<p>Be sure to use parts listed in the service parts list of the applicable model and appropriate tools to conduct repair work. Never attempt to modify the equipment. The use of inappropriate parts or tools may cause an electrical shock, excessive heat generation or fire.</p>	
<p>If the power cable and lead wires are scratched or have deteriorated, be sure to replace them. Damaged cable and wires may cause an electrical shock, excessive heat generation or fire.</p>	
<p>Do not use a joined power cable or extension cable, or share the same power outlet with other electrical appliances, since it may cause an electrical shock, excessive heat generation or fire.</p>	
<p>Be sure to use an exclusive power circuit for the equipment, and follow the local technical standards related to the electrical equipment, the internal wiring regulations, and the instruction manual for installation when conducting electrical work. Insufficient power circuit capacity and improper electrical work may cause an electrical shock or fire.</p>	
<p>Be sure to use the specified cable for wiring between the indoor and outdoor units. Make the connections securely and route the cable properly so that there is no force pulling the cable at the connection terminals. Improper connections may cause excessive heat generation or fire.</p>	
<p>When wiring between the indoor and outdoor units, make sure that the terminal cover does not lift off or dismount because of the cable. If the cover is not mounted properly, the terminal connection section may cause an electrical shock, excessive heat generation or fire.</p>	
<p>Do not damage or modify the power cable. Damaged or modified power cables may cause an electrical shock or fire. Placing heavy items on the power cable, or heating or pulling the power cable may damage it.</p>	





 Warning	
<p>Do not mix air or gas other than the specified refrigerant (R-32 / R-410A / R-22) in the refrigerant system. If air enters the refrigerant system, an excessively high pressure results, causing equipment damage and injury.</p>	
<p>If the refrigerant gas leaks, be sure to locate the leaking point and repair it before charging the refrigerant. After charging the refrigerant, make sure that there is no leak. If the leaking point cannot be located and the repair work must be stopped, be sure to pump-down, and close the service valve, to prevent refrigerant gas from leaking into the room. Refrigerant gas itself is harmless, but it may generate toxic gases when it contacts flames, such as those from fan type and other heaters, stoves and ranges.</p>	
<p>When relocating the equipment, make sure that the new installation site has sufficient strength to withstand the weight of the equipment. If the installation site does not have sufficient strength or the installation work is not conducted securely, the equipment may fall and cause injury.</p>	
<p>Check to make sure that the power cable plug is not dirty or loose, then insert the plug into a power outlet securely. If the plug is dusty or has a loose connection, it may cause an electrical shock or fire.</p>	
<p>When replacing the coin battery in the remote controller, be sure to dispose of the old battery to prevent children from swallowing it. If a child swallows the coin battery, see a doctor immediately.</p>	

 Caution	
<p>Installation of a leakage breaker is necessary in some cases depending on the conditions of the installation site, to prevent electrical shocks.</p>	
<p>Do not install the equipment in a place where there is a possibility of combustible gas leaks. If combustible gas leaks and remains around the unit, it may cause a fire.</p>	
<p>Check to see if parts and wires are mounted and connected properly, and if connections at the soldered or crimped terminals are secure. Improper installation and connections may cause excessive heat generation, fire or an electrical shock.</p>	
<p>If the installation platform or frame has corroded, replace it. A corroded installation platform or frame may cause the unit to fall, resulting in injury.</p>	
<p>Check the earth / grounding, and repair it if the equipment is not properly earthed / grounded. Improper earth / grounding may cause an electrical shock.</p>	

 Caution	
<p>Be sure to measure insulation resistance after the repair, and make sure that the resistance is 1 MΩ or higher. Faulty insulation may cause an electrical shock.</p>	
<p>Be sure to check the drainage of the indoor unit after the repair. Faulty drainage may cause water to enter the room and wet the furniture and floor.</p>	
<p>Do not tilt the unit when removing it. The water inside the unit may spill and wet the furniture and floor.</p>	

2. Icons Used

The following icons are used to attract the attention of the reader to specific information.

Icon	Type of Information	Description
 Warning	Warning	Warning is used when there is danger of personal injury.
 Caution	Caution	Caution is used when there is danger that the reader, through incorrect manipulation, may damage equipment, lose data, get an unexpected result or have to restart (part of) a procedure.
 Note	Note	Note provides information that is not indispensable, but may nevertheless be valuable to the reader, such as tips and tricks.
 Reference	Reference	Reference guides the reader to other places in this binder or in this manual, where he/she will find additional information on a specific topic.

3. Revision History

Month/Year	Version	Revised contents
04 / 2021	SiUS042113E	First edition

Part 1

General Information

1. Applicable Models	10
2. Functions.....	11

1. Applicable Models

Indoor Unit

FTXM09VVJU
FTXM12VVJU
FTXM18VVJU
FTXM24VVJU

Outdoor Unit

RXM09VVJU
RXM12VVJU
RXM18VVJU
RXM24VVJU

2. Functions

Category	Functions	FTXM-V series	
		09/12 class	18/24 class
Basic Functions	Inverter (with inverter power control)	●	●
	Operation limit	Refer to page 167	
	Standby electricity saving	●	●
Compressor	Swing compressor	●	●
	Reluctance DC motor	●	●
Comfortable Airflow	Power-airflow dual flaps	●	●
	Wide-angle louvers	●	●
	Auto-swing (up and down)	●	●
	Auto-swing (right and left)	●	●
	3-D airflow	●	●
	COMFORT AIRFLOW operation (COANDA flap)	●	●
	Draftless airflow in heating	●	●
Comfort Control	Auto fan speed	●	●
	Switchable fan speed	●	●
	Indoor unit quiet operation	●	●
	OUTDOOR UNIT QUIET operation (manual)	●	●
	INTELLIGENT EYE operation (auto energy saving)	●	●
	2-area INTELLIGENT EYE operation (focus and comfort)	●	—
	Quick warming function (preheating operation)	—	●
	Hot-start function	●	●
	Automatic defrosting	●	●
	Fan stop when thermo-off in cooling	●	●
	Automatic operation (cooling and heating)	●	●
	Program dry function	—	—
	Hybrid cooling (dehumidifying function)	●	●
Fan operation	●	●	
Lifestyle Convenience	Inverter powerful operation	●	●
	ECONO operation	●	●
	Indoor unit ON/OFF button	●	●
	Signal reception indicator	●	●
Health and Cleanliness	Titanium apatite deodorizing filter	●	●
	Mold proof air filter	●	●
	Wipe-clean flat panel	●	●
	CLEAN (mold proof) operation	●*1	●*1
	Removable drain pan	●	●
Remote Control and Timer	WEEKLY TIMER operation	●	●
	Count up-down ON/OFF timer	●	●
	24-hour ON/OFF TIMER	●	●
	NIGHT SET mode	●	●
	R/C with back light	●	●
	°F/°C changeover R/C temperature display (factory setting: °F)	●	●
	Wireless LAN adaptor (built in)	●	●
	DIII-NET compatible (adaptor)	option	option
Worry Free (Reliability & Durability)	Auto-restart (after power failure)	●	●
	Self-diagnosis with R/C	●	●
	Anti-corrosion treatment of outdoor heat exchanger	●	●
Flexibility	Chargeless	49.2 ft (15 m)	49.2 ft (15 m)
	Either side drain (right or left)	●	●
	Year-round cooling applicable (−20°C(4°F)) *2	●	●
Remote Control	Wireless	●	●
	Wired	option	option

● : Available

— : Not available

*1 : Factory setting Off

*2 : This operation limit is allowed by installing the air direction adjustment grille (option).

Part 2 Specifications

1. Specifications 13

1. Specifications

Model	Indoor Unit		FTXM09VVJU		FTXM12VVJU	
	Outdoor Unit		RXM09VVJU		RXM12VVJU	
			Cooling	Heating	Cooling	Heating
Power Supply	Phase	1 ϕ		1 ϕ		
	Hz, V	60 Hz, 208 - 230 V		60 Hz, 208 - 230 V		
Capacity Rated (Min. - Max.)	Btu/h	9,000 (4,400 ~ 12,500)	11,000 (4,400 ~ 19,500)	12,000 (4,800 ~ 16,000)	13,600 (4,800 ~ 22,600)	
Power Consumption (Rated)	W	552	701	909	906	
Power Factor (Rated)	%	92.5	94.6	96.2	96.8	
SEER / HSPF		27.40	13.80	25.20	13.00	
EER (Rated)	Btu/Wh	16.30	—	13.20	—	
COP (Rated)	W/W	—	4.60	—	4.40	
Piping Connection	Liquid	in. (mm)	ϕ 1/4 (6.4)		ϕ 1/4 (6.4)	
	Gas	in. (mm)	ϕ 3/8 (9.5)		ϕ 3/8 (9.5)	
	Drain	in. (mm)	ϕ 5/8 (16)		ϕ 5/8 (16)	
Max. Interunit Piping Length	ft (m)	82-1/64 (25)		82-1/64 (25)		
Max. Interunit Height Difference	ft (m)	65-5/8 (20)		65-5/8 (20)		
Chargeless	ft (m)	49.2 (15)		49.2 (15)		
Amount of Additional Charge of Refrigerant	oz/ft (g/m)	0.22 (20)		0.22 (20)		
Indoor Unit			FTXM09VVJU		FTXM12VVJU	
Front Panel Color (Munsell No.)			White (N-9.5)		White (N-9.5)	
Airflow Rates	H	cfm (m ³ /min)	515 (14.6)	515 (14.6)	557 (15.8)	557 (15.8)
	M		340 (9.6)	370 (10.5)	394 (11.2)	412 (11.7)
	L		249 (7.1)	304 (8.6)	292 (8.3)	340 (9.6)
	SL		219 (6.2)	249 (7.1)	225 (6.4)	255 (7.2)
Fan	Type	Cross Flow Fan		Cross Flow Fan		
	Speed	Steps	5 Steps, Quiet, Auto		5 Steps, Quiet, Auto	
Heat Exchanger	Type	Multi Slit Fin		Multi Slit Fin		
	Rows \times Stages, Fin Pitch (mm)	2 \times 18, 1.4 1 \times 8, 1.4 1 \times 4, 1.4		2 \times 18, 1.4 1 \times 8, 1.4 1 \times 4, 1.4		
Dimensions (H \times W \times D)	in. (mm)	11-3/4 \times 36-1/4 \times 10-13/16 (299 \times 920 \times 275)		11-3/4 \times 36-1/4 \times 10-13/16 (299 \times 920 \times 275)		
Packaged Dimensions (H \times W \times D)	in. (mm)	14-15/16 \times 39-3/4 \times 15-3/8 (380 \times 1,010 \times 391)		14-15/16 \times 39-3/4 \times 15-3/8 (380 \times 1,010 \times 391)		
Weight (Mass)	Lbs (kg)	29 (13)		29 (13)		
Gross Weight (Gross Mass)	Lbs (kg)	38 (17)		38 (17)		
Sound Pressure Level (H / M / L / SL)	dB(A)	43 / 33 / 25 / 22	43 / 35 / 30 / 25	45 / 37 / 29 / 23	45 / 39 / 32 / 26	
Outdoor Unit			RXM09VVJU		RXM12VVJU	
Casing Color			Ivory White		Ivory White	
Compressor	Type	Hermetically Sealed Swing Type		Hermetically Sealed Swing Type		
	Model	2Y147BKCX1A		2Y147BKCX1A		
Refrigerant Oil	Type	FW50DA		FW50DA		
	Charge	oz (L)	15.17 (0.430)		15.17 (0.430)	
Refrigerant	Type	R-32		R-32		
	Charge	Lbs (kg)	2.16 (0.98)		2.16 (0.98)	
Airflow Rates	H / SL	cfm (m ³ /min)	1,317 / 1,183 (37.3 / 33.5)	1,296 / 922 (36.7 / 26.1)	1,487 / 1,317 (42.1 / 37.3)	1,487 / 922 (42.1 / 26.1)
Fan	Type	Propeller		Propeller		
Heat Exchanger	Type	Waffle Fin		Waffle Fin		
	Rows \times Stages, Fin Pitch (mm)	2 \times 26, 1.4		2 \times 26, 1.4		
Dimensions (H \times W \times D)	in. (mm)	23-7/16 \times 33-1/4 \times 11-13/16 (595 \times 845 \times 300)		23-7/16 \times 33-1/4 \times 11-13/16 (595 \times 845 \times 300)		
Packaged Dimensions (H \times W \times D)	in. (mm)	26 \times 39-5/8 \times 16-15/16 (660 \times 1,007 \times 430)		26 \times 39-5/8 \times 16-15/16 (660 \times 1,007 \times 430)		
Weight (Mass)	Lbs (kg)	96 (44)		96 (44)		
Gross Weight (Gross Mass)	Lbs (kg)	103 (47)		103 (47)		
Sound Pressure Level (H / SL)	dB(A)	47 / —		49 / —		
Conditions Based on		Indoor ; 80°FDB (26.7°CDB) / 67°FWB (19.4°CWB) Outdoor ; 95°FDB (35°CDB) / 75°FWB (24°CWB) Piping Length: 25 ft (7.5 m)	Indoor ; 70°FDB (21.1°CDB) / 60°FWB (15.6°CWB) Outdoor ; 47°FDB (8.3°CDB) / 43°FWB (6.1°CWB) Piping Length: 25 ft (7.5 m)	Indoor ; 80°FDB (26.7°CDB) / 67°FWB (19.4°CWB) Outdoor ; 95°FDB (35°CDB) / 75°FWB (24°CWB) Piping Length: 25 ft (7.5 m)	Indoor ; 70°FDB (21.1°CDB) / 60°FWB (15.6°CWB) Outdoor ; 47°FDB (8.3°CDB) / 43°FWB (6.1°CWB) Piping Length: 25 ft (7.5 m)	
Drawing No.	3D133578A		3D133578A		3D133578A	
Notes	SL: The quiet fan level of the airflow rate setting.		SL: The quiet fan level of the airflow rate setting.		SL: The quiet fan level of the airflow rate setting.	

Conversion Formulae
kcal/h = kW \times 860
Btu/h = kW \times 3412
cfm = m ³ /min \times 35.3

Model	Indoor Unit		FTXM18VVJU		FTXM24VVJU	
	Outdoor Unit		RXM18VVJU		RXM24VVJU	
			Cooling	Heating	Cooling	Heating
Power Supply	Phase	1 ϕ		1 ϕ		
	Hz, V	60 Hz, 208 - 230 V		60 Hz, 208 - 230 V		
Capacity Rated (Min. - Max.)	Btu/h	18,000 (9,000 ~ 22,000)	21,600 (9,000 ~ 30,200)	21,600 (9,000 ~ 26,000)	24,000 (9,000 ~ 32,200)	
Power Consumption (Rated)	W	1,440	1,665	1,728	1,986	
Power Factor (Rated)	%	95.4	97.6	97.3	99	
SEER / HSPF		22.70	12.50	22.00	12.50	
EER (Rated)	Btu/Wh	12.50	—	12.50	—	
COP (Rated)	W/W	—	3.80	—	3.54	
Piping Connection	Liquid	in. (mm)	ϕ 1/4 (6.4)		ϕ 1/4 (6.4)	
	Gas	in. (mm)	ϕ 1/2 (12.7)		ϕ 5/8 (15.9)	
	Drain	in. (mm)	ϕ 5/8 (16)		ϕ 5/8 (16)	
Max. Interunit Piping Length	ft (m)	98-1/2 (30)		98-1/2 (30)		
Max. Interunit Height Difference	ft (m)	82-1/64 (25)		82-1/64 (25)		
Chargeless	ft (m)	49.2 (15)		49.2 (15)		
Amount of Additional Charge of Refrigerant	oz/ft (g/m)	0.22 (20)		0.22 (20)		
Indoor Unit			FTXM18VVJU		FTXM24VVJU	
Front Panel Color (Munsell No.)			White (N-9.5)		White (N-9.5)	
Airflow Rates	H	cfm (m ³ /min)	776 (22.0)	776 (22.0)	845 (23.9)	845 (23.9)
	M		583 (16.5)	559 (15.8)	652 (18.5)	606 (17.2)
	L		482 (13.7)	467 (13.2)	498 (14.1)	498 (14.1)
	SL		428 (12.1)	413 (11.7)	451 (12.8)	451 (12.8)
Fan	Type	Cross Flow Fan		Cross Flow Fan		
	Speed	Steps	5 Steps, Quiet, Auto		5 Steps, Quiet, Auto	
Heat Exchanger	Type	Multi Slit Fin		Multi Slit Fin		
	Rows \times Stages, Fin Pitch (mm)	2 \times 18, 1.4 1 \times 8, 1.4 1 \times 4, 1.4		2 \times 18, 1.4 1 \times 8, 1.4 1 \times 4, 1.4		
Dimensions (H \times W \times D)	in. (mm)	11-3/4 \times 43-5/16 \times 10-13/16 (299 \times 1,100 \times 275)		11-3/4 \times 43-5/16 \times 10-13/16 (299 \times 1,100 \times 275)		
Packaged Dimensions (H \times W \times D)	in. (mm)	15-13/16 \times 47-11/16 \times 15-1/2 (401 \times 1,212 \times 393)		15-13/16 \times 47-11/16 \times 15-1/2 (401 \times 1,212 \times 393)		
Weight (Mass)	Lbs (kg)	33 (15)		33 (15)		
Gross Weight (Gross Mass)	Lbs (kg)	46 (21)		46 (21)		
Sound Pressure Level (H / M / L / SL)	dB(A)	49 / 41 / 36 / 33	49 / 40 / 35 / 32	51 / 44 / 37 / 34	51 / 42 / 37 / 34	
Outdoor Unit			RXM18VVJU		RXM24VVJU	
Casing Color			Ivory White		Ivory White	
Compressor	Type	Hermetically Sealed Swing Type		Hermetically Sealed Swing Type		
	Model	2Y260BPBX1A		2Y260BPBX1A		
Refrigerant Oil	Type	FW68DA		FW68DA		
	Charge	oz (L)	31.75 (0.900)		31.75 (0.900)	
Refrigerant	Type	R-32		R-32		
	Charge	Lbs (kg)	2.98 (1.35)		2.98 (1.35)	
Airflow Rates	H / SL	cfm (m ³ /min)	2,119 / 1,833 (60.0 / 51.9)	2,062 / 1,773 (58.4 / 50.2)	2,179 / 1,833 (61.7 / 51.9)	2,119 / 1,833 (60.0 / 51.9)
Fan	Type	Propeller		Propeller		
Heat Exchanger	Type	Waffle Fin		Waffle Fin		
	Rows \times Stages, Fin Pitch (mm)	2 \times 32, 1.4		2 \times 32, 1.4		
Dimensions (H \times W \times D)	in. (mm)	28-15/16 \times 34-1/4 \times 12-5/8 (735 \times 870 \times 320)		28-15/16 \times 34-1/4 \times 12-5/8 (735 \times 870 \times 320)		
Packaged Dimensions (H \times W \times D)	in. (mm)	31-7/8 \times 41-1/2 \times 18-1/4 (810 \times 1,056 \times 464)		31-7/8 \times 41-1/2 \times 18-1/4 (810 \times 1,056 \times 464)		
Weight (Mass)	Lbs (kg)	132 (60)		132 (60)		
Gross Weight (Gross Mass)	Lbs (kg)	143 (65)		143 (65)		
Sound Pressure Level (H / SL)	dB(A)	54 / —		55 / —		
Conditions Based on		Indoor ; 80°FDB (26.7°CDB) / 67°FWB (19.4°CWB) Outdoor ; 95°FDB (35°CDB) / 75°FWB (24°CWB) Piping Length: 25 ft (7.5 m)	Indoor ; 70°FDB (21.1°CDB) / 60°FWB (15.6°CWB) Outdoor ; 47°FDB (8.3°CDB) / 43°FWB (6.1°CWB) Piping Length: 25 ft (7.5 m)	Indoor ; 80°FDB (26.7°CDB) / 67°FWB (19.4°CWB) Outdoor ; 95°FDB (35°CDB) / 75°FWB (24°CWB) Piping Length: 25 ft (7.5 m)	Indoor ; 70°FDB (21.1°CDB) / 60°FWB (15.6°CWB) Outdoor ; 47°FDB (8.3°CDB) / 43°FWB (6.1°CWB) Piping Length: 25 ft (7.5 m)	
Drawing No.	3D133579		3D133579		3D133579	
Notes	SL: The quiet fan level of the airflow rate setting.		SL: The quiet fan level of the airflow rate setting.		SL: The quiet fan level of the airflow rate setting.	

Conversion Formulae
kcal/h = kW \times 860
Btu/h = kW \times 3412
cfm = m ³ /min \times 35.3

Part 3 Printed Circuit Board Connector Wiring Diagram

1. Indoor Unit.....	16
2. Outdoor Unit.....	20
2.1 09/12 class	20
2.2 18/24 class	21

1. Indoor Unit

Control PCB (A1P)

- 1) S16 Connector for optional adaptor
- 2) S21 Connector for optional adaptor
- 3) S200 Connector for DC fan motor
- 4) S300A, S301B Connector for power supply PCB (A2P)
- 5) S400 Connector for swing motors
- 6) S501 Connector for indoor heat exchanger thermistor (R1T)
- 7) S600 Connector for humidity sensor PCB (A4P)
- 8) S602 Connector for INTELLIGENT EYE sensor PCB (A5P)
- 9) S800 Connector for display/signal receiver PCB (A3P)
- 10) S801 Connector for wireless LAN connection PCB (A6P)

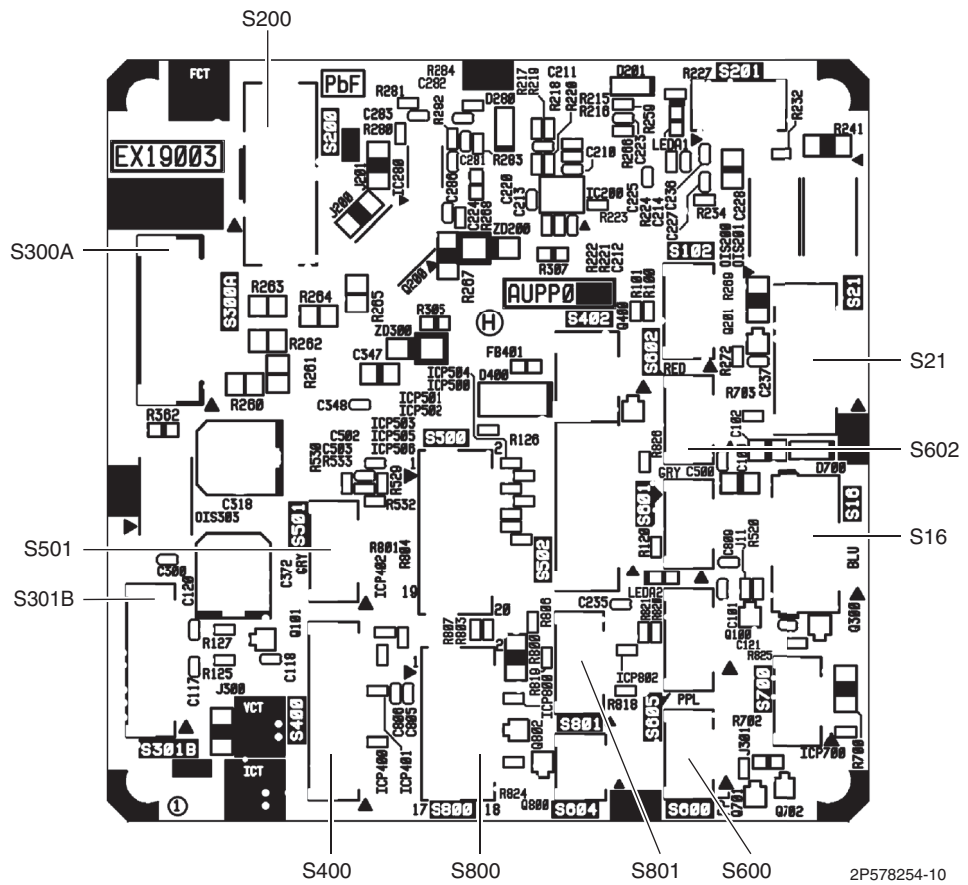

Power Supply PCB (A2P)

- 1) S101 Connector for terminal strip (indoor-outdoor transmission)
- 2) S102, S103 Connector for control PCB (A1P)
- 3) FG Connector for terminal strip (frame ground)
- 4) F1U Fuse (3.15 A, 250 V)
- 5) R1V Varistor

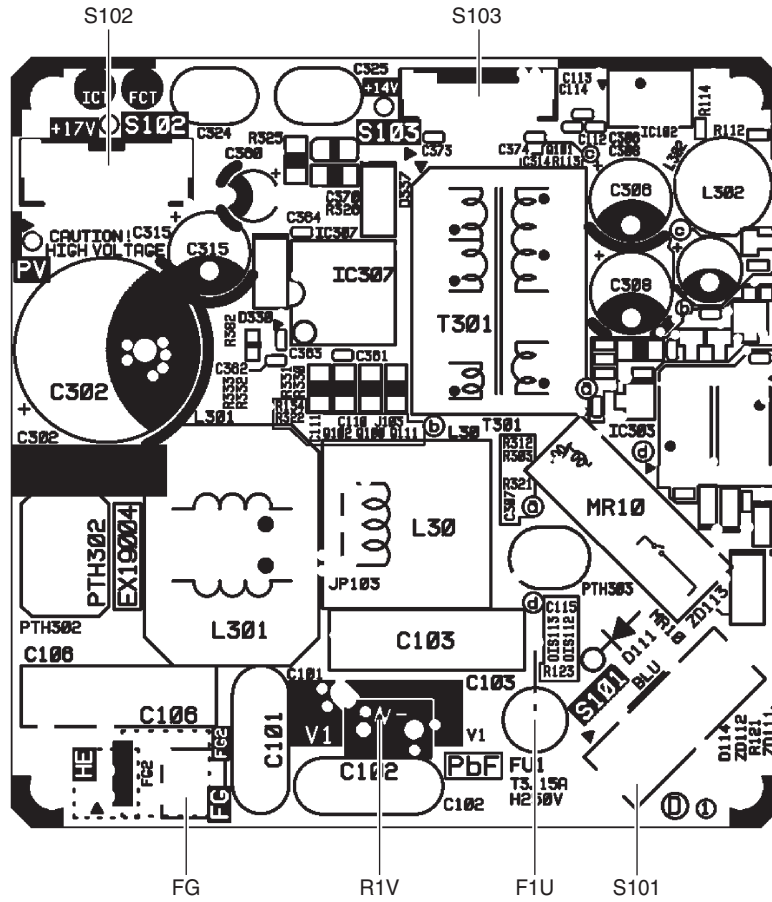

2P578255-7

Display/Signal Receiver PCB (A3P)

- 1) S920 Connector for control PCB (A1P)
- 2) BS1 Indoor unit **ON/OFF** switch
(Forced cooling operation **ON/OFF** switch)
Refer to page 149 for details of forced cooling operation.
- 3) H1P LED for operation (green)
- 4) H2P LED for timer (yellow)
- 5) H3P LED for CLEAN operation (green)
- 6) H4P LED for INTELLIGENT EYE (green)
- 7) H5P LED for wireless LAN connection (yellow)

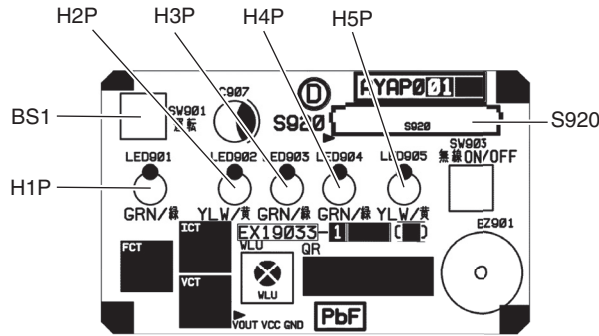

3P579849-1

Humidity Sensor PCB (A4P)

- 1) Connector Connector for control PCB (A1P)

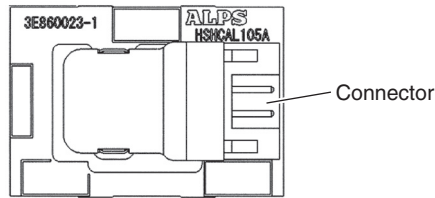

3E860023-1

INTELLIGENT EYE Sensor PCB (A5P)

- 1) Connector Connector for control PCB (A1P)

09/12 class

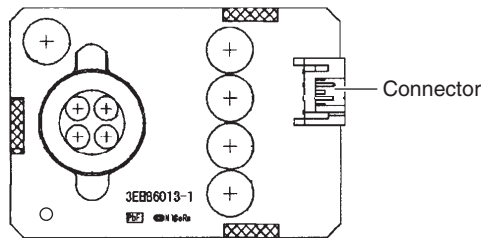

3EB86013-1

18/24 class

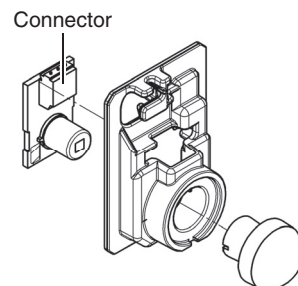

3P629375-1

**Wireless LAN
connection PCB
(A6P)**

- 1) Connector

Connector for control PCB (A1P)

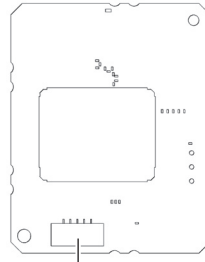

2P571193-4

2. Outdoor Unit

2.1 09/12 class

Main PCB (A1P)

- | | | |
|-----|-------------|--|
| 1) | S20 | Connector for electronic expansion valve coil |
| 2) | S40 | Connector for overload protector |
| 3) | S70 | Connector for DC fan motor |
| 4) | S80 | Connector for four way valve |
| 5) | S90 | Connector for thermistors
(outdoor temperature, outdoor heat exchanger, discharge pipe temperature) |
| 6) | S97 | Connector for liquid pipe thermistor |
| 7) | HL1, HN1, S | Wire harness for terminal strip |
| 8) | E1, E2 | Wire harness for earth/ground wire |
| 9) | U, V, W | Wire harness for compressor |
| 10) | FU1, FU2 | Fuse (3.15 A, 250 V) |
| 11) | FU3 | Fuse (30 A, 250 V) |
| 12) | LEDA | LED for service monitor (green) |
| 13) | V1, V2, V3 | Varistor |
| 14) | J4 | Jumper for facility setting
Refer to page 153 for details. |
| 15) | J9 | Jumper for drain pan heater
Refer to page 154 for details. |

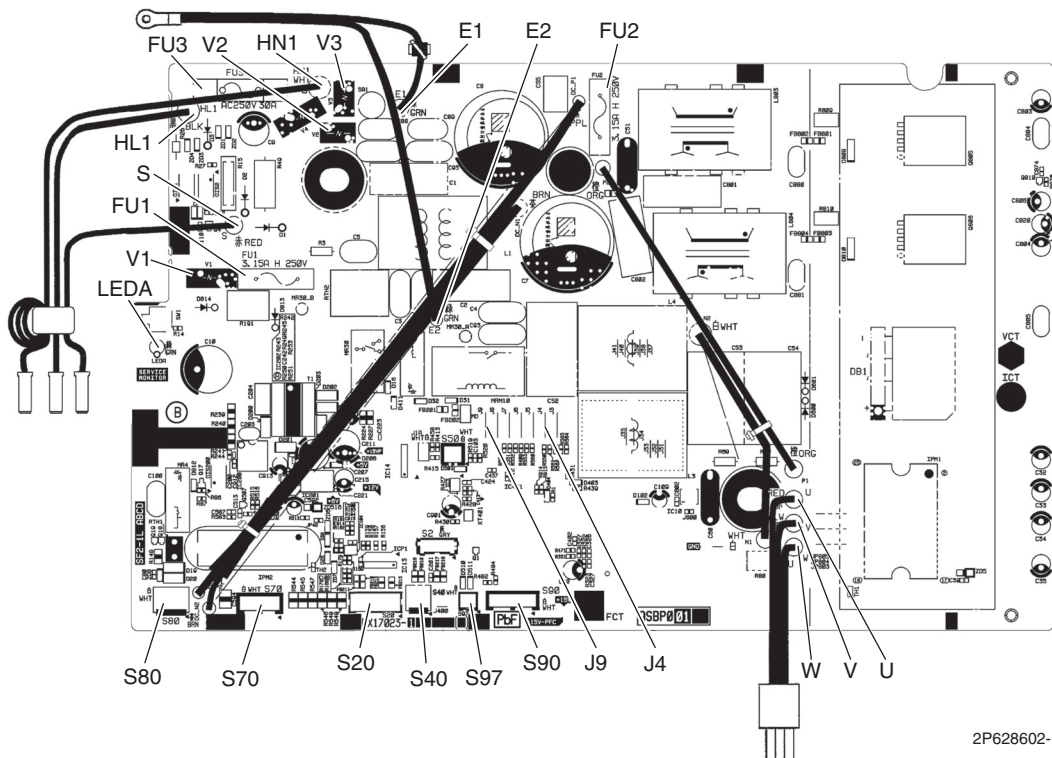

Caution

Replace the PCB if you cut a jumper unintentionally.

Jumpers are necessary for electronic circuit. Improper operation may occur if you cut any of them.

2.2 18/24 class

Main PCB (A1P)

- | | | |
|-----|--------------|--|
| 1) | S | Connector for terminal block (indoor - outdoor transmission) |
| 2) | S20 | Connector for electronic expansion valve coil (White) |
| 3) | S40 | Connector for overload protector |
| 4) | S70 | Connector for DC fan motor |
| 5) | S80 | Connector for four way valve coil |
| 6) | S90 | Connector for thermistors
(outdoor temperature, outdoor heat exchanger, discharge pipe,
liquid pipe) |
| 7) | S201, S202 | Wire harness for service monitor PCB (A2P) |
| 8) | CK1 | Wire harness for voltage endurance test |
| 9) | HL1, HN1 | Wire harness for terminal block (power supply) |
| 10) | E1, E2 | Wire harness for earth/ground wire |
| 11) | U, V, W | Wire harness for compressor |
| 12) | FU1, FU2 | Fuse (3.15 A, 250 V) |
| 13) | FU3 | Fuse (30 A, 250 V) |
| 14) | V2, V3, V401 | Varistor |

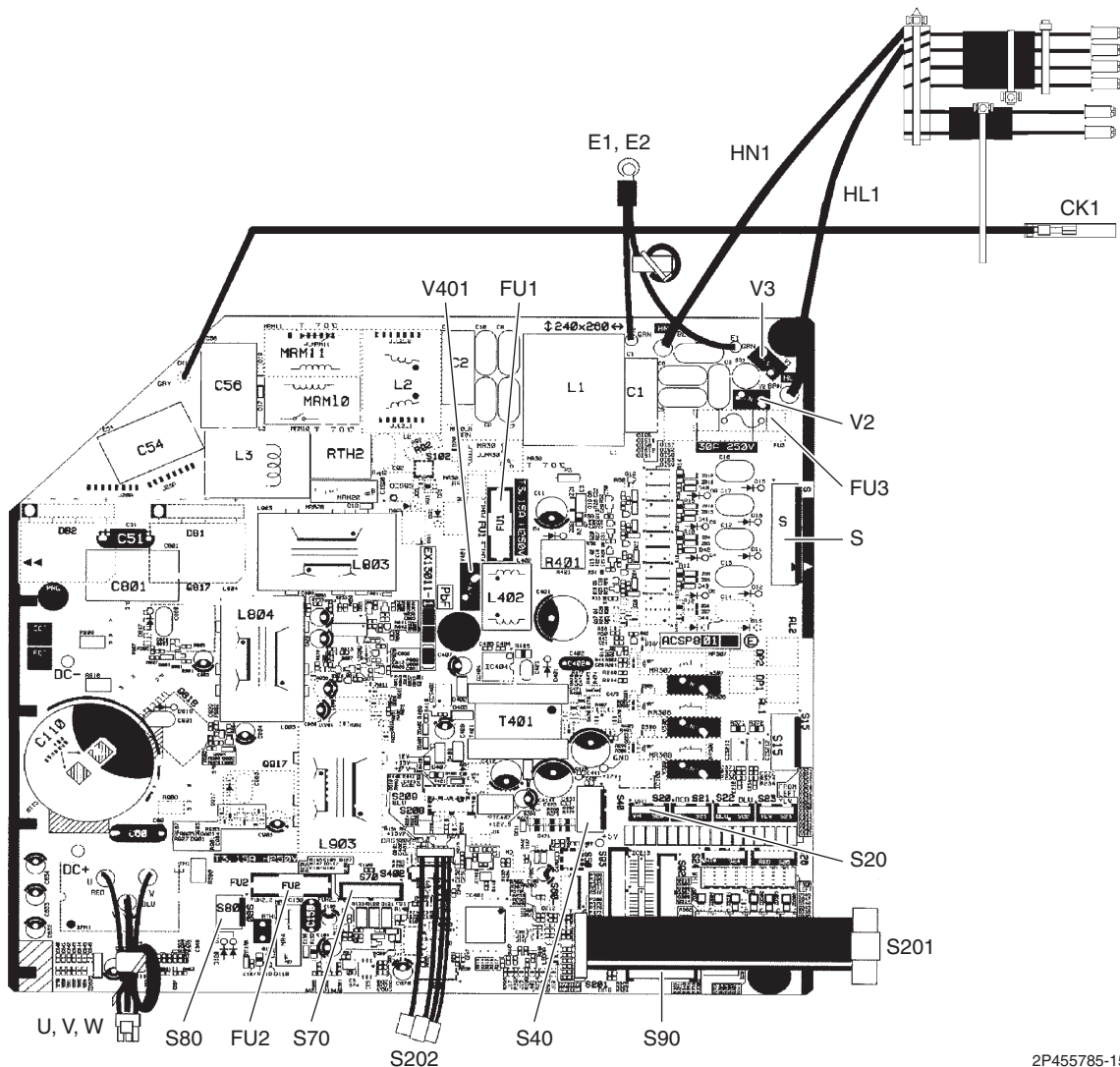

2P455785-15

Service Monitor PCB (A2P)

- 1) S501, S502 Connector for main PCB (A1P)
- 2) LEDA LED for service monitor (green)
- 3) SW5-3 Switch for facility setting
Refer to page 153 for details.
- 4) SW6-1 Switch for drain pan heater
Refer to page 154 for details.

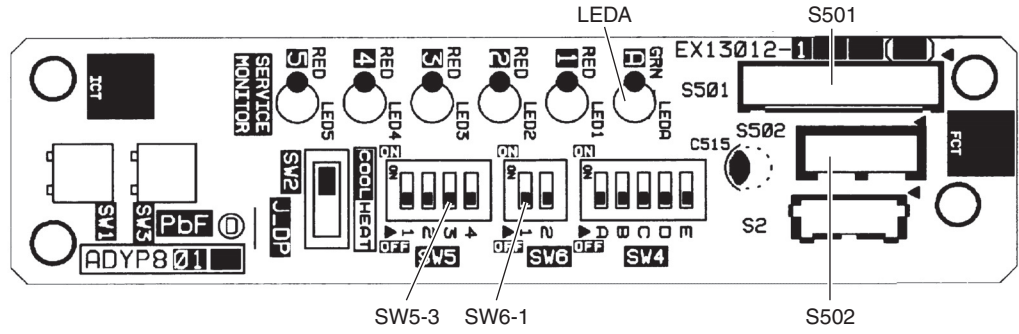

3P346711-10

★ SW1 ~ SW4 and LED1 ~ LED5 do not work.

Part 4

Functions and Control

1. Main Functions	24
1.1 Temperature Control	24
1.2 Frequency Principle.....	24
1.3 Airflow Direction Control.....	26
1.4 COMFORT AIRFLOW Operation	27
1.5 Fan Speed Control for Indoor Unit	29
1.6 Hybrid Cooling.....	30
1.7 Automatic Cooling/Heating Changeover	33
1.8 Thermostat Control.....	34
1.9 NIGHT SET Mode	35
1.10 ECONO Operation	35
1.11 2-Area INTELLIGENT EYE Operation	36
1.12 INTELLIGENT EYE Operation	40
1.13 POWERFUL Operation	42
1.14 Clock Setting	43
1.15 WEEKLY TIMER Operation	44
1.16 Brightness Setting of Indoor Unit Display.....	50
1.17 CLEAN Operation.....	51
1.18 Wireless LAN Connection	53
1.19 Other Functions.....	58
2. Thermistor Functions	59
3. Control Specification	61
3.1 Mode Hierarchy	61
3.2 Frequency Control.....	61
3.3 Standby Electricity Saving (Suspend Function)	63
3.4 Controls at Mode Changing/Start-up.....	64
3.5 Discharge Pipe Temperature Control.....	66
3.6 Input Current Control.....	67
3.7 Freeze-up Protection Control	68
3.8 Heating Peak-cut Control	68
3.9 High Pressure Protection Control.....	69
3.10 Outdoor Fan Control.....	70
3.11 Liquid Compression Protection Function.....	70
3.12 Defrost Control	71
3.13 Electronic Expansion Valve Control	72
3.14 Malfunctions	75

1. Main Functions

1.1 Temperature Control

Definitions of Temperatures

The definitions of temperatures are classified as following.

- Room temperature: temperature of lower part of the room
- Set temperature: temperature set by remote controller
- Room thermistor temperature: temperature detected by room temperature thermistor
- Target temperature: temperature determined by microcomputer

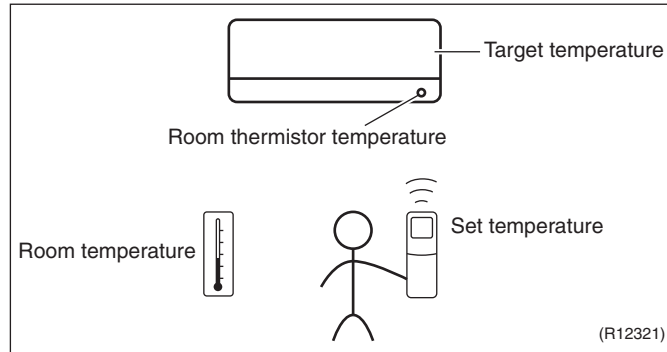

Temperature Control

The temperature of the room is detected by the room temperature thermistor. However, there is a difference between the temperature detected by room temperature thermistor and the temperature of lower part of the room, depending on the type of the indoor unit or installation condition. In practice, the temperature control is done by the target temperature appropriately adjusted for the indoor unit and the temperature detected by room temperature thermistor.

1.2 Frequency Principle

Control Parameters

The frequency of the compressor is controlled by the following 2 parameters:

- The load condition of the operating indoor unit
- The difference between the room thermistor temperature and the target temperature

The target frequency is adapted by additional parameters in the following cases:

- Frequency restrictions
- Initial settings
- Forced cooling operation

Inverter Principle

To regulate the capacity, a frequency control is needed. The inverter makes it possible to control the rotation speed of the compressor. The followings explain the inverter principle:

Phase 1

The supplied AC power source is converted into the DC power source for the present.

Phase 2

The DC power source is reconverted into the three phase AC power source with variable frequency.

- When the frequency increases, the rotation speed of the compressor increases resulting in an increase of refrigerant circulation. This leads to a larger amount of heat exchange per unit.

- When the frequency decreases, the rotation speed of the compressor decreases resulting in a decrease of refrigerant circulation. This leads to a smaller amount of heat exchange per unit.

The following drawing shows a schematic view of the inverter principle:

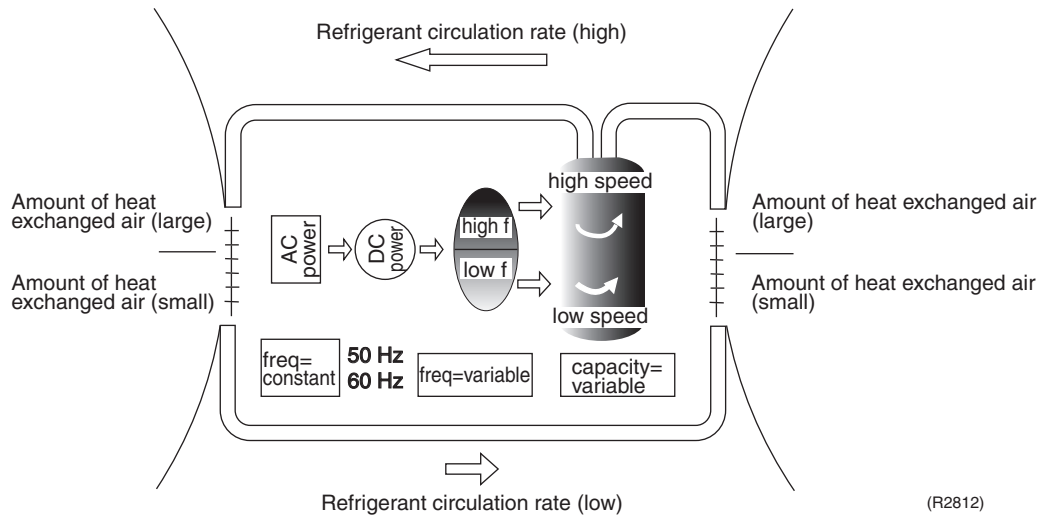

Inverter Features

The inverter provides the following features:

- The regulating capacity can be changed according to the changes in the outdoor temperature and cooling/heating load.
- Quick heating and quick cooling
The rotation speed of the compressor is increased when starting the heating (cooling). This enables to reach the set temperature quickly.
- Even during extreme cold weather, high capacity is achieved. It is maintained even when the outdoor temperature is 2°C (35.6°F).
- Comfortable air conditioning
A fine adjustment is integrated to keep the room temperature constant.
- Energy saving heating and cooling
Once the set temperature is reached, the energy saving operation enables to maintain the room temperature at low power.

Frequency Limits

The following functions regulate maximum frequency:

Low frequency

- Four way valve operation compensation. Refer to page 64.

High frequency

- Compressor protection function. Refer to page 65.
- Discharge pipe temperature control. Refer to page 66.
- Input current control. Refer to page 67.
- Freeze-up protection control. Refer to page 68.
- Heating peak-cut control. Refer to page 68.
- Defrost control. Refer to page 71.

Forced Cooling Operation

Refer to page 149 for details.

1.3 Airflow Direction Control

Power-Airflow Dual Flaps

The large flap sends a large volume of air downward to the floor and provides an optimum control in cooling, dry and heating operation.

Cooling/Dry

During cooling or dry operation, the flap retracts into the indoor unit. Then, cool air can be blown far and distributed all over the room.

Heating

During heating operation, the large flap directs airflow downward to spread the warm air to the entire room.

Wide-Angle Louvers

The louvers, made of elastic synthetic resin, provide a wide range of airflow that guarantees comfortable air distribution.

Auto-Swing

The following tables explain the auto-swing process for cooling, dry, heating and fan:

Flap (up and down)			Louver (right and left)
Cooling/Dry	Heating	Fan	
<p>R4003783</p>	<p>R4003784</p>	<p>R4003785</p>	<p>R4003764</p>

3-D Airflow

Alternative repetition of vertical and horizontal swing motions enables uniform air-conditioning of the entire room.

When the horizontal swing and vertical swing are both set to automatic operation, the airflow becomes 3-D airflow. The horizontal and vertical swing motions are alternated and the airflow direction changes in the order shown in the following diagram.

- (1) The vertical blades (louvers) move from the right to the left.
- (2) The horizontal blades (flaps) move downward.
- (3) The vertical blades (louvers) move from the left to the right.
- (4) The horizontal blades (flaps) move upward.

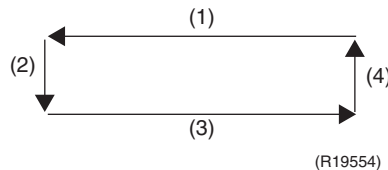

1.4 COMFORT AIRFLOW Operation

Outline

New flap structure is developed with technology Coanda. In cooling operation, ceiling airflow provides cool air upward along the ceiling as far as entire the room. In heating operation, draftless airflow directs warm air straight downward to your feet.

- Apply new airflow system, providing a comfortable cooling and heating space without draft feeling and spreading comfort airflow with large air volume in low velocity with double airflow technology to disseminate a wide of airflow in low velocity even with the large air volume.
- Wind reaches far
Reaching distance 16.4 ft (5 m) (for 09/12 class), 32.8 ft (10 m) (for 18/24 class)
The comfort mode is set during cooling. Measure the distance that can secure a wind speed of 0.4 m/s or more at a position of 1.18 inch (30 mm) from the ceiling.

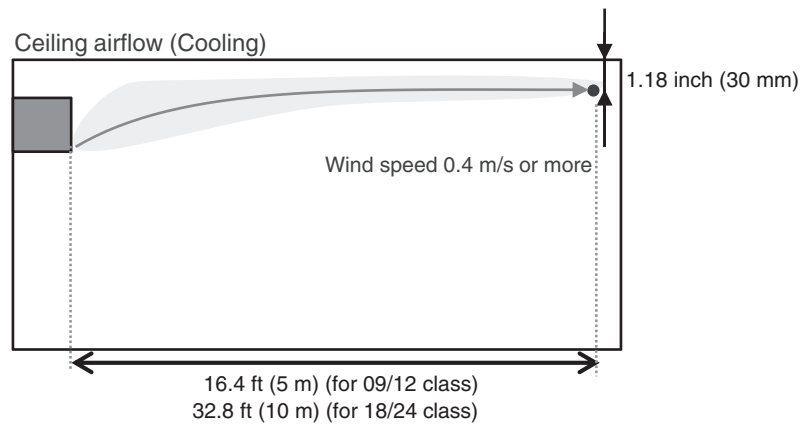

R4003805

Reaching distance 9.84 ft (3 m) (for all class)

The comfort mode is set during heating. Measure the distance that can secure a wind speed of 0.3 m/s or less at a position of 3.28 ft (1 m) from the floor.

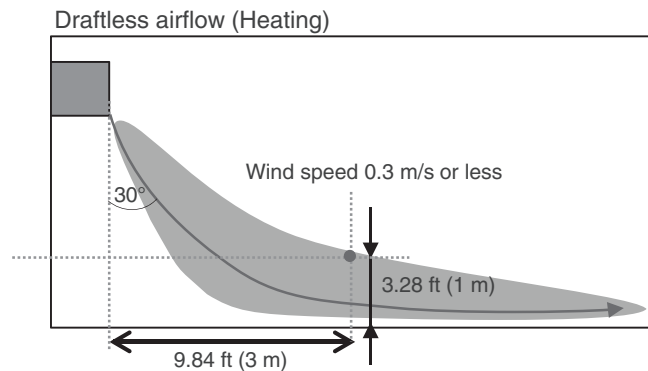

*Floor temperature sensor is not mounted on.

R4003809

Operation

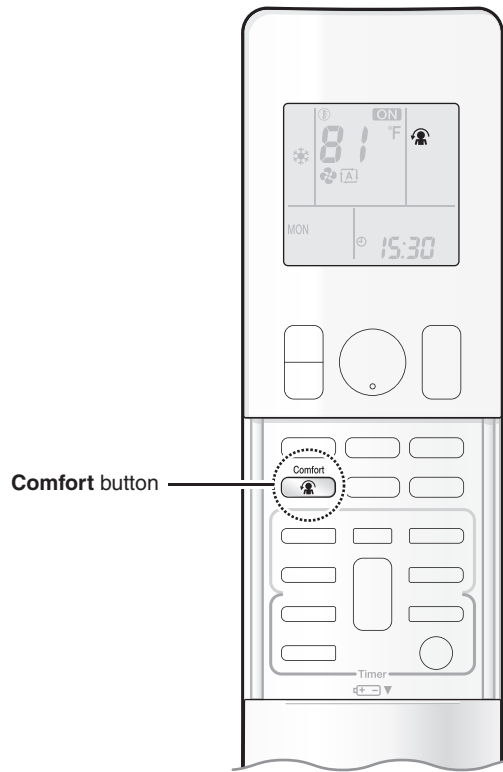

To start the operation:
 ■ Press **Comfort** button.
 The icon appears on the display.

	COOL / DRY operation	HEAT operation	FAN operation
Flaps direction	Goes up	Goes down	Not available
Airflow rate	AUTO		

To stop the operation:
 ■ Press **Comfort** button again.
 The icon disappears from the display. The flaps will return to the memory position from before COMFORT AIRFLOW operation

i Note(s)

- POWERFUL operation and COMFORT AIRFLOW operation cannot be used at the same time.
- The airflow rate will be set to AUTO.
- If the upward and downward airflow direction is selected, the COMFORT AIRFLOW function will be canceled. Priority is given to the function of whichever button is pressed last.
- If there is an obstruction under the air conditioner when using heating, the airflow may not reach the center of the room and the room may be difficult to warm up.

1.5 Fan Speed Control for Indoor Unit

Outline

Phase control and fan speed control contains 9 steps: LLL, LL, SL, L, ML, M, MH, H, and HH. The airflow rate can be automatically controlled depending on the difference between the room thermistor temperature and the target temperature.

Automatic Fan Speed Control

In automatic fan speed operation, the step SL is not available.

Step	Cooling	Heating
LLL	↕	↕
LL		
L		
ML		
M		
MH		
H		
HH (POWERFUL)		

R4003512

↕ = The airflow rate is automatically controlled within this range when **FAN** setting button is set to automatic.

■ **Cooling**

The following drawing explains the principle of fan speed control for cooling.

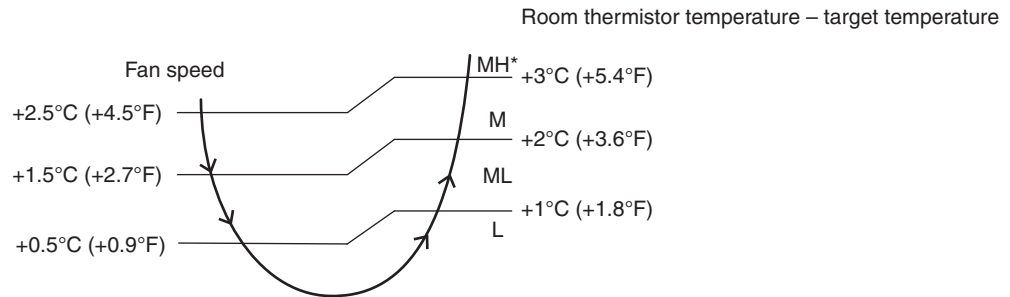

(R21654)

* The upper limit is at M tap in 30 minutes from the operation start.

■ **Heating**

In heating operation, the fan speed is regulated according to the indoor heat exchanger temperature and the difference between the room thermistor temperature and the target temperature.



Note(s)

The fan stops during defrost operation.

1.6 Hybrid Cooling

Operation

Hybrid cooling becomes effective when COOL or DRY is selected from **MODE** button of the remote controller. In cooling operation, hybrid cooling is automatically activated when the room temperature approaches to the target temperature set from the remote controller. When more cooling capacity is required, the operation automatically returns to the normal cooling operation. During dry operation, in addition to the above, the indoor unit fan is automatically controlled to help dehumidification.

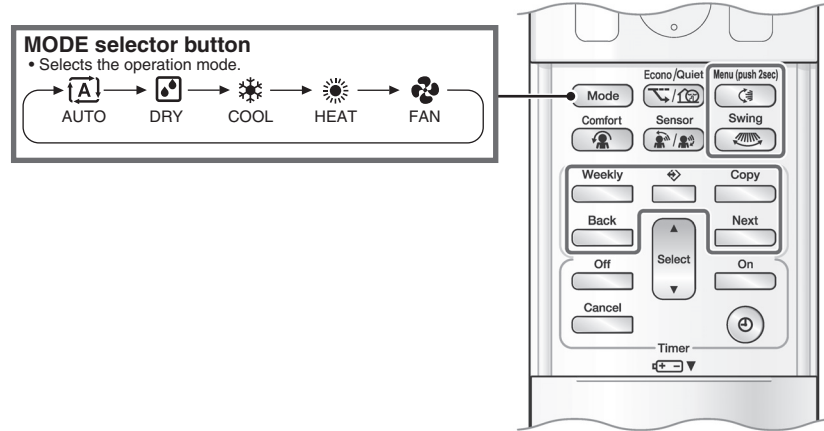

R4003786

Outline

In hybrid cooling, only a part of the heat exchanger is cooled. The cool, dehumidified air is mixed with the room air, and then blown out at around the same temperature with the room air. This is to keep dehumidification effect after the target temperature is reached. The area of the heat exchanger to be cooled is determined automatically based on the amount of humidity to remove. Particularly, when the amount of humidity is large, the area of the heat exchanger to be cooled also becomes large. When the amount of humidity is small, the area of heat exchanger becomes small, too.

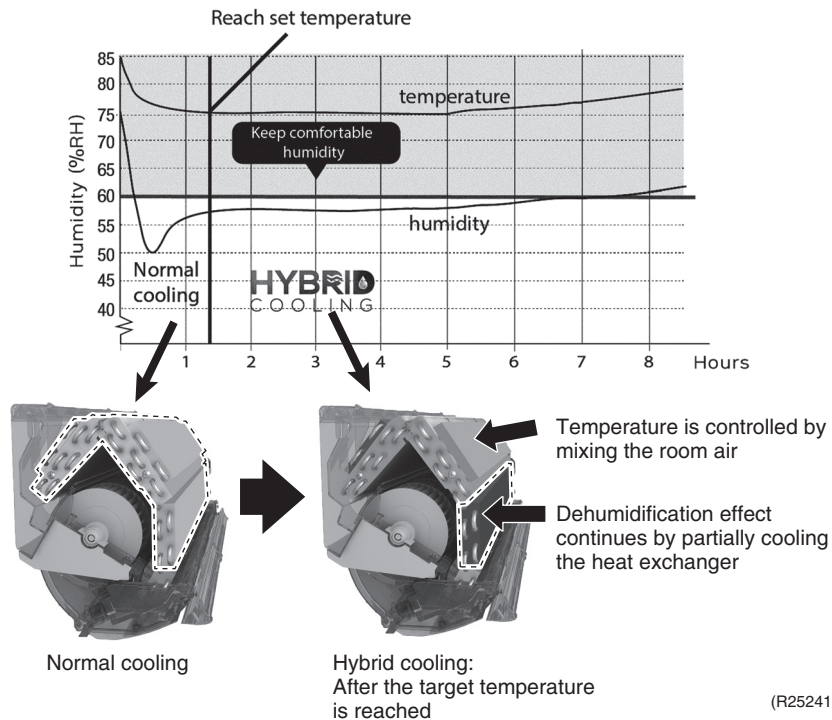

(R25241)

Details

■ Humidity to be removed

The amount of air to be dehumidified changes depending on the amount of humidity to be removed. To remove the larger amount of humidity, the amount of air passing through the heat exchanger becomes larger while the absolute humidity difference unchanged.

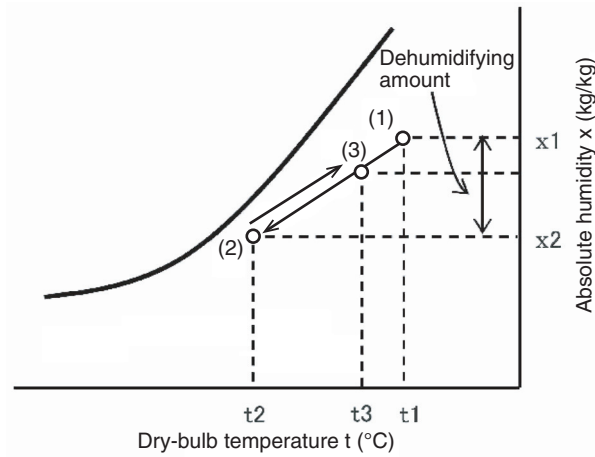

(R25238)

- (1) Suction air
- (2) Dehumidified suction air (air passed through the cooled part of the heat exchanger)
- (3) Dehumidified air mixed with room air

■ Room temperature control in dry operation

Room temperature zones in dry operation are described as below.

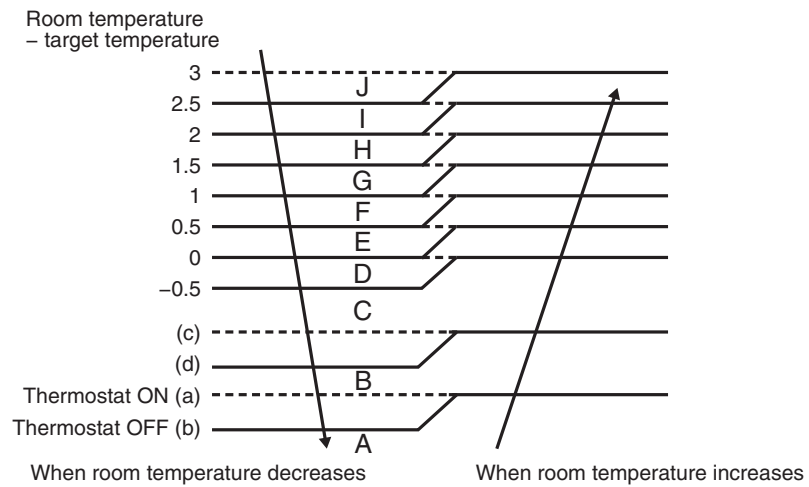

(R25242)

Refer to the table below for (a) Thermostat ON and (b) Thermostat OFF values in various room temperatures when dry operation is started.

Temperature when dry operation is started	(a) Thermostat ON	(b) Thermostat OFF	(c)	(d)
26°C (78.8°F) ≤ Room temperature	-2.5°C (-4.5°F)	-3°C (-5.4°F)	-1.5°C (-2.7°F)	-2°C (-3.6°F)
23°C (73.4°F) ≤ Room temperature < 26°C (78.8°F)	-2.5°C (-4.5°F)	-3°C (-5.4°F)	-1.5°C (-2.7°F)	-2°C (-3.6°F)
Room temperature < 23°C (73.4°F)	-2°C (-3.6°F)	-2.5°C (-4.5°F)	-1°C (-1.8°F)	-1.5°C (-2.7°F)

* Refer to Thermostat Control on P. 34 for details.

Indoor unit fan control in dry operation

During dry operation, fan rotation speed is automatically controlled according to the room temperature zones shown above and airflow rate cannot be set manually. In addition, fan rotation speed is also adjusted with the room humidity.

* In all steps from H to L, the fan rotation speed is specific to dry operation and different from that in cooling operation.

Room temperature zone	Fan tap
J	H
I	
H	MH
G	
F	
E	M
D	
C	ML
B	L
A	

Liquid pipe temperature control using electronic expansion valve

Evaporation temperature in indoor unit is controlled to make the temperature indicated by the liquid pipe thermistor, near the outlet side of the electronic expansion valve, reach the target temperature.

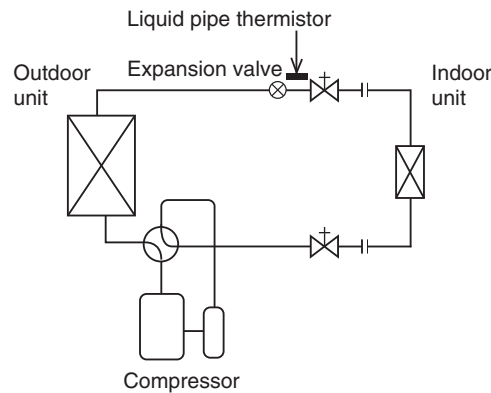

R4003500

1.7 Automatic Cooling/Heating Changeover

Outline

When the automatic operation is selected with the remote controller, the microcomputer automatically determines the operation mode as cooling or heating according to the room temperature and the set temperature at start-up.

The unit automatically switches the operation mode to maintain the room temperature at the set temperature.

Details

Ts: set temperature (set by remote controller)

Tt: target temperature (determined by microcomputer)

Tr: room thermistor temperature (detected by room temperature thermistor)

C: correction value

- The set temperature (Ts) determines the target temperature (Tt).
(Ts = 18 ~ 30°C (64.4 ~ 86°F))
- The target temperature (Tt) is calculated as;
Tt = Ts + C
where C is the correction value.
C = 0°C (0°F)
- Thermostat ON/OFF point and operation mode switching point are as follows.
 - Heating → Cooling switching point:
 $Tr \geq Tt + 3.0^{\circ}\text{C}$ (+ 5.4°F)
 - Cooling → Heating switching point:
 $Tr < Tt - 2.5^{\circ}\text{C}$ (- 4.5°F)
 - Thermostat ON/OFF point is the same as the ON/OFF point of cooling or heating operation.
- During initial operation
Tr ≥ Ts : Cooling operation
Tr < Ts : Heating operation

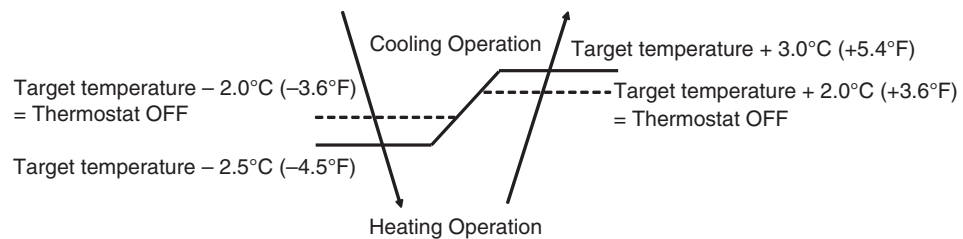

Ex: When the target temperature is 25°C (77°F)

Cooling → 23°C (73.4°F): Thermostat OFF → 22.5°C (72.5°F): Switch to heating

Heating → 27°C (80.6°F): Thermostat OFF → 28°C (82.4°F): Switch to cooling

R4003810

1.8 Thermostat Control

Outline

Thermostat control is based on the difference between the room thermistor temperature and the target temperature.

Details

Thermostat OFF Conditions

- The temperature difference is in the zone A.

Thermostat ON Conditions

- The temperature difference returns to the zone C after being in the zone A.
- The system resumes from defrost control in any zones except A.
- The operation turns on in any zones except A.
- The monitoring time has passed while the temperature difference is in the zone B.
(Cooling: 10 minutes, Heating: 10 seconds)

Cooling

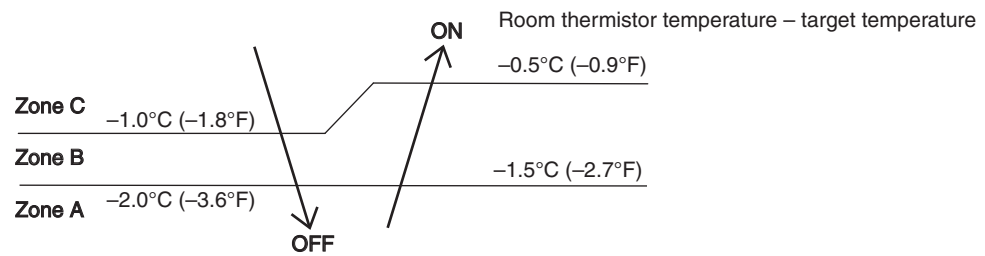

Heating

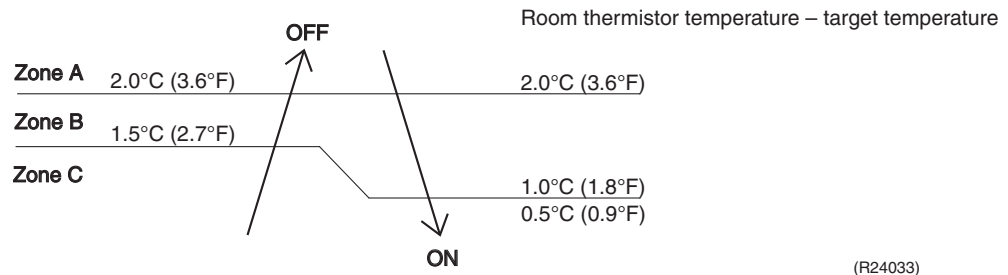

Reference

Refer to Temperature Control on page 24 for details.

1.9 NIGHT SET Mode

Outline When the OFF TIMER is set, NIGHT SET mode is automatically activated. NIGHT SET mode keeps the airflow rate setting.

Details NIGHT SET mode continues operation at the target temperature for the first one hour, then automatically raises the target temperature slightly in the case of cooling, or lowers the target temperature slightly in the case of heating. This prevents excessive cooling in summer and excessive heating in winter to ensure comfortable sleeping conditions, and also conserves electricity.

Cooling

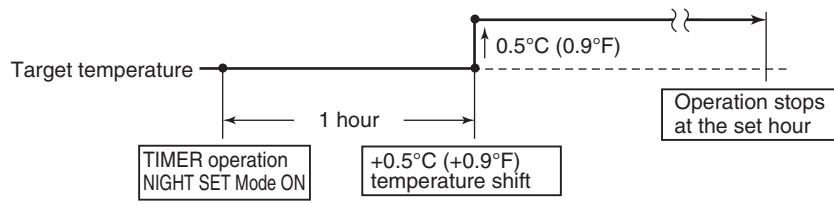

(R23917)

Heating

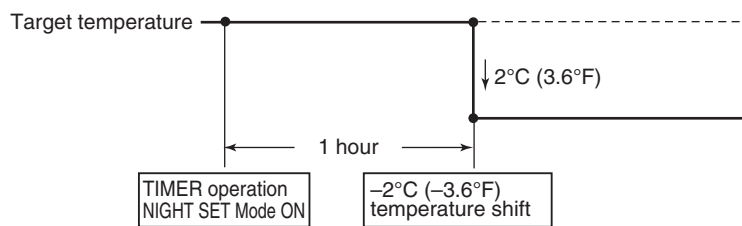

(R23918)

1.10 ECONO Operation

Outline ECONO operation reduces the maximum operating current and the power consumption. This operation is particularly convenient for energy-saving. It is also a major bonus when breaker capacity does not allow the use of multiple electrical devices and air conditioners. It can be easily activated by pressing **Econo/Quiet** button on the wireless remote controller.

Details

- When this function is activated, the maximum capacity also decreases.
- The remote controller can send the ECONO command when the unit is in cooling, heating, dry, or automatic operation. This function can only be set when the unit is running. To cancel the ECONO operation, press **Econo/Quiet** button several times until the ECONO symbol disappears.
- This function and POWERFUL operation cannot be used at the same time. The latest command has the priority.

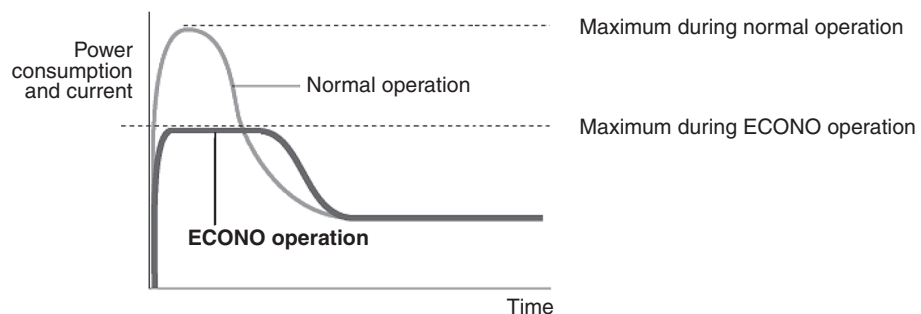

(R22012)

To start operation

- Press the **Econo/Quiet** button and select the desired mode.
 - Each time the **Econo/Quiet** button is pressed, a different setting option is displayed on the LCD.

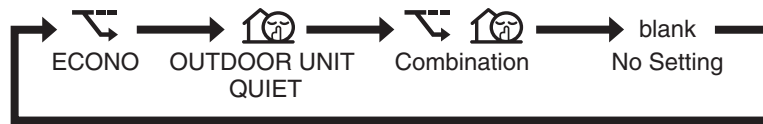
**To cancel operation**

- Press the **Econo/Quiet** button until no icon is displayed.

**Note(s)**

- This operation is performed with lower power and therefore may not provide a sufficient cooling (heating) effect.
- Pressing the **ON/OFF** button causes the settings to be canceled, and the ECONO icon disappears from the LCD.
- If the power consumption level is already low, switching to ECONO operation will not reduce the power consumption.

1.11 2-Area INTELLIGENT EYE Operation

Applicable Models

FTXM09/12VVJU

Outline

The following functions can be performed by the microcomputer and a motion sensor.

1. Reduction of the capacity when there is nobody in the room in order to save electricity (energy saving operation)
2. Dividing the room into plural areas and detecting presence of humans in each area. Moving the airflow direction to the area with no human automatically to avoid direct airflow on humans.

Details

1. INTELLIGENT EYE detection method

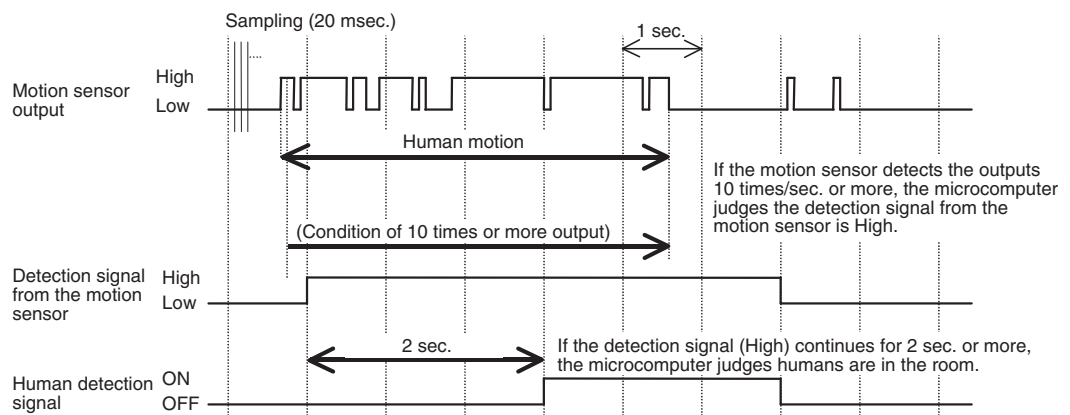

R4003811

- The motion sensor detects human motion by receiving infrared rays and sends the pulse wave output.
- The microcomputer in the indoor unit carries out a sampling every 20 msec. If the motion sensor detects 10 times or more of the wave output in one second in total, and the High signal continues for 2 sec., the microcomputer judges humans are in the room as the human detection signal is ON.
- 2-area INTELLIGENT EYE motion sensor divides the area into 2 and detects presence of humans in each area.

Image of 2-area INTELLIGENT EYE

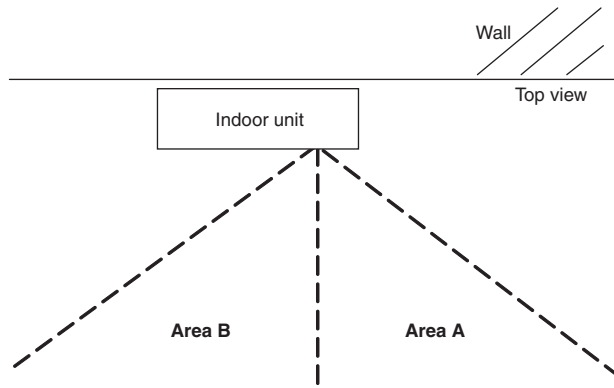

A microcomputer judges human presence by the human detection signal from each area A and B.

(R22951)

2. Motions (in cooling)

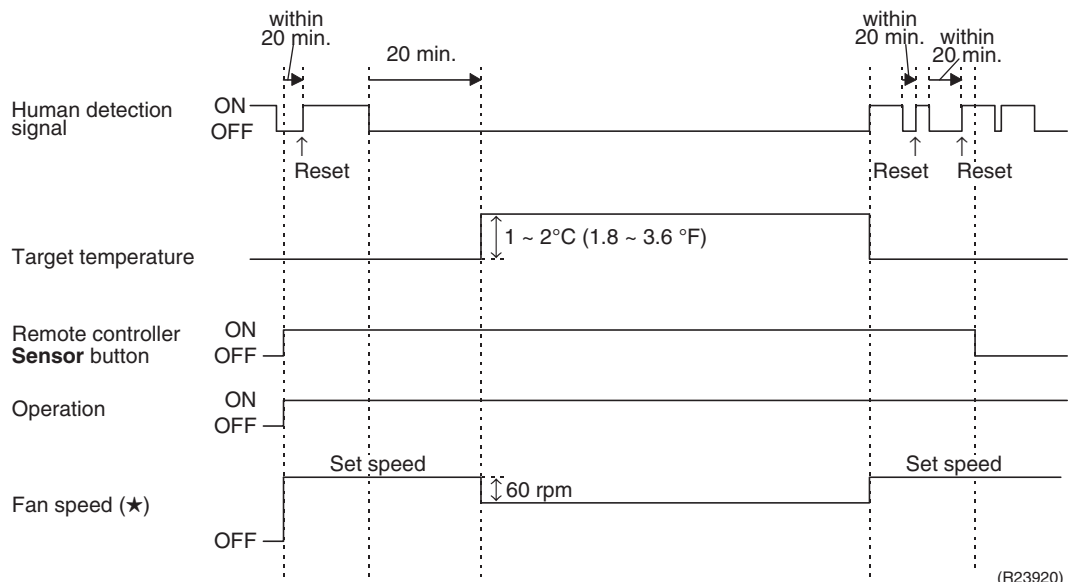

(R23920)

- ★ In FAN operation, the fan speed is reduced by 60 rpm when no one is in the area.
- When there is no signal from the motion sensor in 20 minutes, the microcomputer judges that nobody is in the room and operates the unit at a temperature shifted from the target temperature. (Cooling/Dry: $1 \sim 2^{\circ}\text{C}$ ($1.8 \sim 3.6^{\circ}\text{F}$) higher, Heating: 2°C (3.6°F) lower, Auto: according to the operation mode at that time)

3. Airflow direction in 2-area INTELLIGENT EYE operation

- Detection method: The opposite area of detected area is set as the target direction.

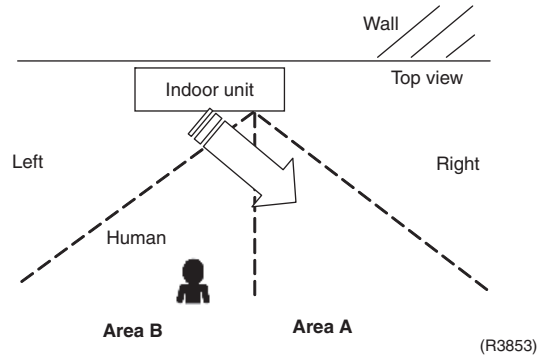

1. Human detection signal ON in both areas A and B: Shift the airflow direction to area B (left side)
2. Human detection signal ON in area A: Shift the airflow direction to area B (left side)
3. Human detection signal ON in area B: Shift the airflow direction to area A (right side)
4. Human detection signal OFF in both areas A and B: No change

* When the human detection signal is OFF for 20 minutes in both areas A and B, the unit starts energy saving operation.

i Note(s)

For dry operation, the temperature cannot be set with a remote controller, but the target temperature is shifted internally.

Comfort/Focus Airflow

Depending on the settings, you can select the airflow control whether blowing directly toward (Focus) or away from (Comfort) the people.

[Example]

	A person is detected in area 1.	A person is detected in area 2.	People are detected in both areas.	No people are detected in the areas.
			When INTELLIGENT EYE operation is used, the unit will not blow air directly at people (only in their general direction).	The air conditioner will switch to energy-saving mode after 20 minutes.

* The airflow direction may differ from the illustrated direction depending on the actions and movements of the people in the areas.

R4003787

i Note(s)

Notes on energy saving operation

- If no presence detected in the room for 20 minutes, the energy saving operation will start, and the INTELLIGENT EYE lamp goes off.
If human movement is detected again, the INTELLIGENT EYE lamp lights up and energy saving operation terminates.
- This operation changes the temperature by -3.6°F (-2.0°C) in HEAT / $+3.6^{\circ}\text{F}$ ($+2.0^{\circ}\text{C}$) in COOL / $+3.6^{\circ}\text{F}$ ($+2.0^{\circ}\text{C}$) in DRY operation from the set temperature.
When the room temperature exceeds 86°F (30.0°C), the operation changes the temperature by $+1.8^{\circ}\text{F}$ ($+1.0^{\circ}\text{C}$) in COOL / $+1.8^{\circ}\text{F}$ ($+1.0^{\circ}\text{C}$) in DRY operation from the set temperature.
- This operation decreases the airflow rate slightly in FAN operation only.

Notes on INTELLIGENT EYE operation

- Application range is as follows.

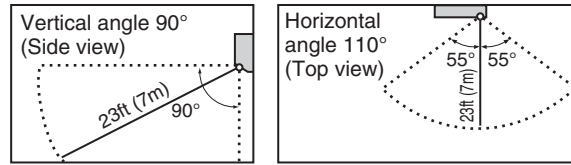

- If the air conditioner is in INTELLIGENT EYE operation and the mode “Do not blow directly on people” is selected, the louvers adjust the airflow direction if there are people in the sensing areas of the INTELLIGENT EYE so that the leftward or rightward airflow will not be directed to the people. If no people are detected in either area 1 or 2 for 20 minutes, the air conditioner switches to the energy-saving mode with the set temperature shifted by 3.6°F (2.0°C). The air conditioner may switch to the energy-saving operation even if there are people in the areas. This may occur depending on the clothes the people are wearing, if there is no movement of the people in the areas.
- The airflow direction from the louvers will be leftward if there are people in both areas 1 and 2. The air will also flow left if there is a person right in front of the sensor as the sensor judges that there are people in both areas.
- Due to the position of the sensor, people might be exposed to the airflow of the indoor unit if they are close to the front side of the indoor unit. If there are people close to the front side of the indoor unit or in both areas, it is recommended to use the COMFORT AIRFLOW and INTELLIGENT EYE operations simultaneously. Using both modes together, the air conditioner will not direct the airflow towards the people.
- The sensor could also mistakenly detect pets, sunlight, fluttering curtains and light reflected off of mirrors as passers-by.
- The sensor may not detect moving objects further than 23ft (7m) away. (Please see the application range)
- Sensor detection sensitivity changes according to the indoor unit location, the speed of passers-by, temperature range, etc.
- NIGHT SET mode will not switch on during use of INTELLIGENT EYE operation.

1.12 INTELLIGENT EYE Operation

Applicable Models FTXM18/24VVJU

Outline This function detects the presence of humans in the room with a motion sensor and reduces the capacity when there is nobody in the room in order to save electricity.

Details **1. INTELLIGENT EYE detection method**

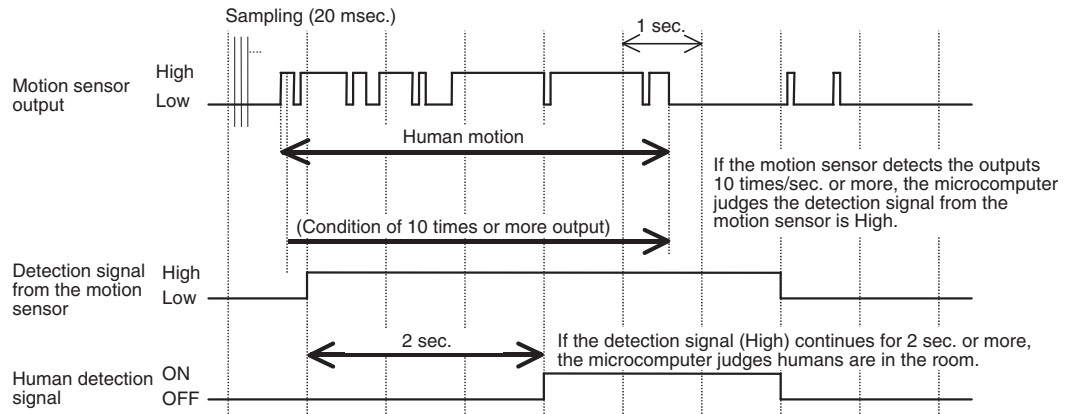

R4003811

- The motion sensor detects human motion by receiving infrared rays and sends the pulse wave output.
- The microcomputer in the indoor unit carries out a sampling every 20 msec. If the motion sensor detects 10 times or more of the wave output in one second in total, and the High signal continues for 2 sec., the microcomputer judges humans are in the room as the human detection signal is ON.

2. Motions (in cooling)

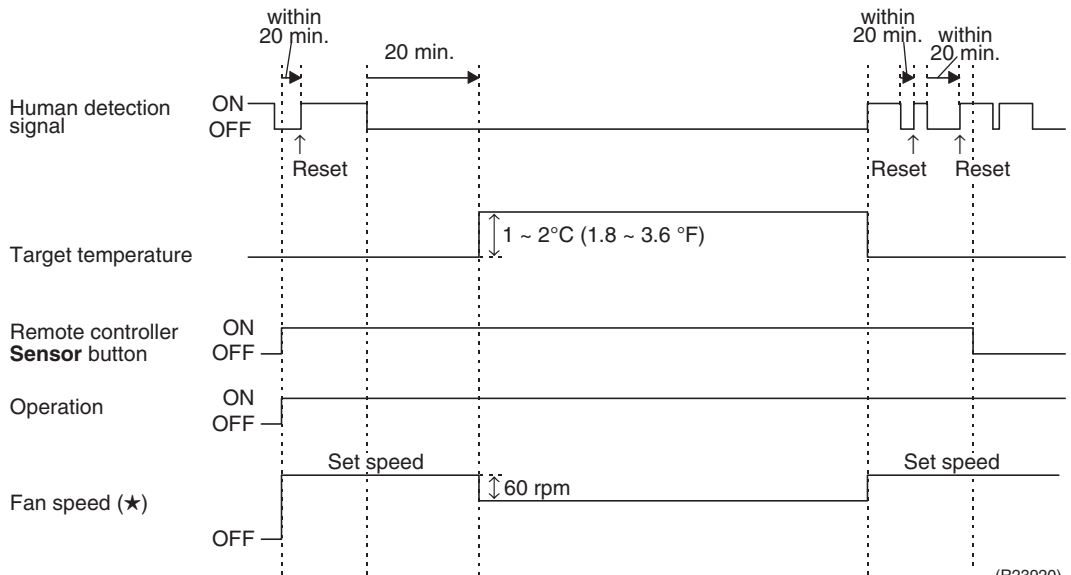

(R23920)

- ★ In FAN operation, the fan speed is reduced by 60 rpm when no one is in the area.
- When there is no signal from the motion sensor in 20 minutes, the microcomputer judges that nobody is in the room and operates the unit at a temperature shifted from the target temperature. (Cooling/Dry: 1 ~ 2°C (1.8 ~ 3.6°F) higher, Heating: 2°C (3.6°F) lower, Auto: according to the operation mode at that time)

**Note(s)**

For dry operation, the temperature cannot be set with a remote controller, but the target temperature is shifted internally.

Notes on Energy saving operation

- If no presence detected in the room for 20 minutes, the energy saving operation will start, and the INTELLIGENT EYE lamp goes off.
If human movement is detected again, the INTELLIGENT EYE lamp lights up and energy saving operation terminates.
- This operation changes the temperature by -3.6°F (-2.0°C) in HEAT / $+3.6^{\circ}\text{F}$ ($+2.0^{\circ}\text{C}$) in COOL / $+3.6^{\circ}\text{F}$ ($+2.0^{\circ}\text{C}$) in DRY operation from the set temperature.
When the room temperature exceeds 86°F (30.0°C), the operation changes the temperature by $+1.8^{\circ}\text{F}$ ($+1.0^{\circ}\text{C}$) in COOL / $+1.8^{\circ}\text{F}$ ($+1.0^{\circ}\text{C}$) in DRY operation from the set temperature.
- This operation decreases the airflow rate slightly in FAN operation only.

Notes on INTELLIGENT EYE operation

- Application range is as follows.

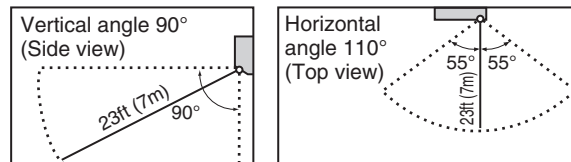

- The air conditioner may switch to the energy-saving operation even if there are people in the areas.
This may occur depending on the clothes the people are wearing, if there is no movement of the people in the areas.
- The sensor could also mistakenly detect pets, sunlight, fluttering curtains and light reflected off of mirrors as passers-by.
- The sensor may not detect moving objects further than 23ft (7m) away. (Please see the application range)
- Sensor detection sensitivity changes according to the indoor unit location, the speed of passers-by, temperature range, etc.
- NIGHT SET mode will not switch on during use of INTELLIGENT EYE operation.

1.13 POWERFUL Operation

Outline

In order to exploit the cooling and heating capacity to full extent, the air conditioner can be operated by increasing the indoor fan rotating speed and the compressor frequency.

Details

When **POWERFUL** button is pressed, the fan speed and target temperature are converted to the following states for 20 minutes.

Operation mode	Fan speed	Target temperature
COOL	H tap + A rpm	18°C (64.4°F)
DRY	Dry rotating speed + A rpm	Lowered by 2.5°C (4.5°F)
HEAT	H tap + A rpm	31°C (87.8°F)
FAN	H tap + A rpm	—
AUTO	Same as cooling/heating in POWERFUL operation	The target temperature is kept unchanged.

A = 70 ~ 80 rpm

Ex: POWERFUL operation in cooling

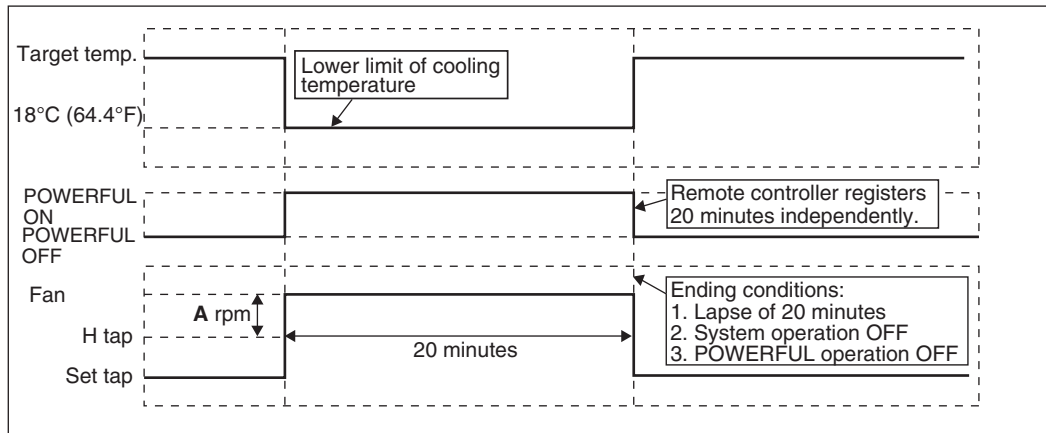

(R24589)

i Notes

POWERFUL operation cannot be used together with ECONO, COMFORT AIRFLOW or OUTDOOR UNIT QUIET operation.

1.14 Clock Setting

ARC466 Series

The clock can be set by taking the following steps:

1. Press **Clock** button.
→ 0:00 is displayed, then **MON** and ☺ blink.
2. Press **Select ▲** or **Select ▼** button to set the clock to the current day of the week.
3. Press **Clock** button.
→ ☺ blinks.
4. Press **Select ▲** or **Select ▼** button to set the clock to the present time.
Holding down **Select ▲** or **Select ▼** button rapidly increases or decreases the time display.
5. Press **Clock** button to set the clock. Point the remote controller at the indoor unit when pressing the button.
→ ⌂ blinks and clock setting is completed.

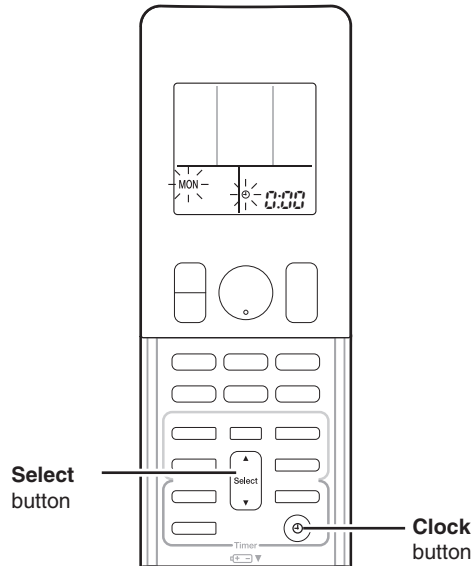

(R19926)

1.15 WEEKLY TIMER Operation

Outline

Up to 4 timer settings can be saved for each day of the week (up to 28 settings in total).
The 3 items: ON/OFF, temperature, and time can be set.

Details

Setting example of the WEEKLY TIMER

The same timer settings are used from Monday through Friday, while different timer settings are used for the weekend.

<p>[Monday]</p>	<p>Make timer settings for programs 1-4.</p>
<p>[Tuesday to Friday]</p>	<p>Use the copy mode to make settings for Tuesday to Friday, because these settings are the same as those for Monday.</p>
<p>[Saturday]</p>	<p>No timer settings</p>
<p>[Sunday]</p>	<p>Make timer settings for programs 1-4.</p>

- Up to 4 reservations per day and 28 reservations per week can be set using the WEEKLY TIMER. The effective use of the copy mode simplifies timer programming.
- The use of ON-ON-ON-ON settings, for example, makes it possible to schedule operating mode and set temperature changes. Furthermore, by using OFF-OFF-OFF-OFF settings, only the turn off time of each day can be set. This will turn off the air conditioner automatically if you forget to turn it off.

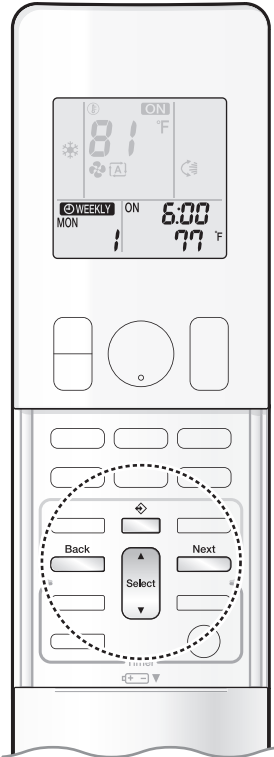

To use WEEKLY TIMER operation

Setting mode

- Make sure the day of the week and time are set.
If not, set the day of the week and time.

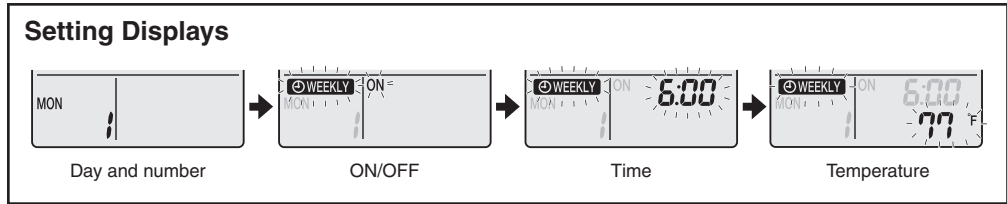
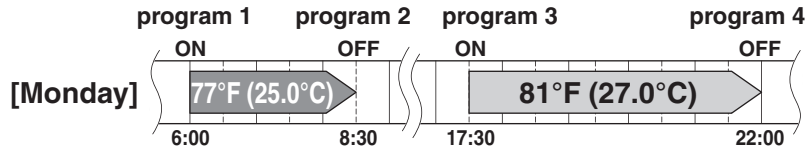

1. Press [Next].

- The day of the week and the reservation number of the current day will be displayed.
- 1 to 4 settings can be made per day.

2. Press [Select] to select the desired day of the week and reservation number.

- Pressing [Select] changes the reservation number and the day of the week.

3. Press [Next].

- The day of the week and reservation number will be set.
- “WEEKLY” and “ON” blink.

4. Press [Select] to select the desired mode.

- Pressing [Select] changes the “ON” or “OFF” setting in sequence.



- In case the reservation has already been set, selecting “blank” deletes the reservation.
- Proceed to **STEP 9** if “blank” is selected.
- To return to the day of the week and reservation number setting, press [Back].

5. Press [Next].

- The ON/OFF TIMER mode will be set.
- “WEEKLY” and the time blink.

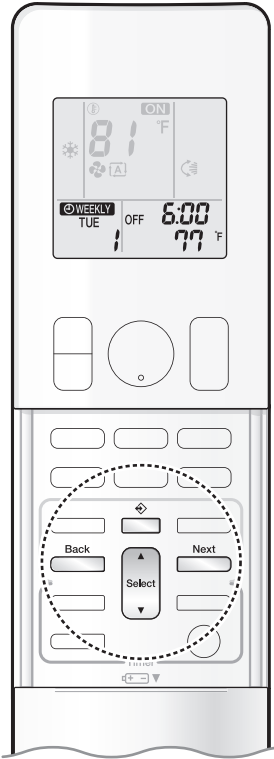

6. Press to select the desired time.

- The time can be set between 0:00 and 23:50 in 10-minute intervals.
- To return to the ON/OFF TIMER mode setting, press .
- Proceed to **STEP 9** when setting the OFF TIMER.

7. Press .

- The time will be set.
- “ WEEKLY” and the temperature blink.

8. Press to select the desired temperature.

- The temperature can be set between 50°F (10.0°C) and 90°F (32.0°C).
COOL or AUTO: The unit operates at 64°F (18.0°C) even if it is set at 50°F (10.0°C) to 63°F (17.0°C).
HEAT or AUTO : The unit operates at 86°F (30.0°C) even if it is set at 87°F (31.0°C) to 90°F (32.0°C).
- To return to the time setting, press .
- The set temperature is only displayed when the mode setting is on.

9. Press .

- Check for a receiving tone and that the OPERATION lamp blinks twice.
- The TIMER lamp lights orange.
- Temperature and time are set in the case of ON TIMER operation, and the time is set in the case of OFF TIMER operation.
- The next reservation screen will appear.
- To continue further settings, repeat the procedure from **STEP 4**.

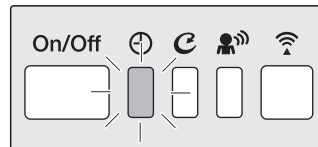



Display

10. Press to complete the setting.

- “ WEEKLY” is displayed on the LCD and WEEKLY TIMER operation is activated.
- A reservation made once can be easily copied and the same settings used for another day of the week. Refer to **Copy mode**.

NOTE

Notes on WEEKLY TIMER operation

- Do not forget to set the clock on the remote controller first.
- The day of the week, ON/OFF TIMER mode, time and set temperature (only for ON TIMER mode) can be set with the WEEKLY TIMER.
When set to ON TIMER mode, operation will begin in the settings used previously for operation mode, temperature, airflow rate, and airflow direction.
- WEEKLY TIMER and ON/OFF TIMER operation cannot be used at the same time. The ON/OFF TIMER operation has priority if it is set while WEEKLY TIMER is still active. The WEEKLY TIMER will enter the standby state, and “ WEEKLY” will disappear from the LCD. When the ON/OFF TIMER is up, the WEEKLY TIMER will automatically become active.
- Turning off the circuit breaker, power failure, and other similar events will render operation of the indoor unit's internal clock inaccurate. Reset the clock.
-  can be used only for the time and temperature settings. It cannot be used to go back to the reservation number.

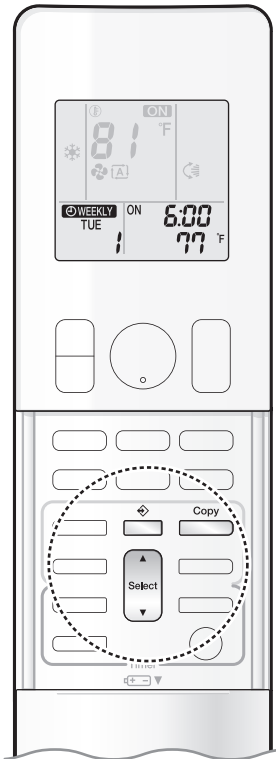

Copy mode

- A reservation made once can be copied to another day of the week. The whole reservation of the selected day of the week will be copied.

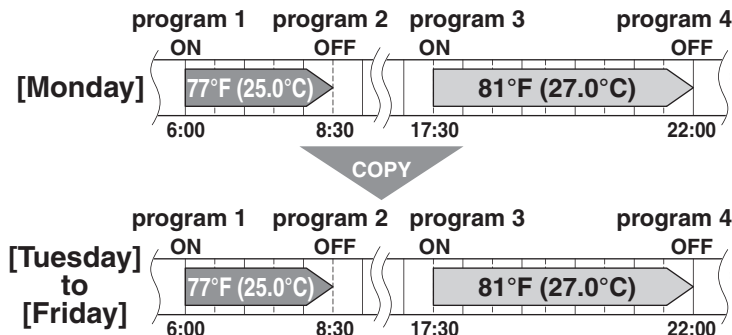

Setting Displays

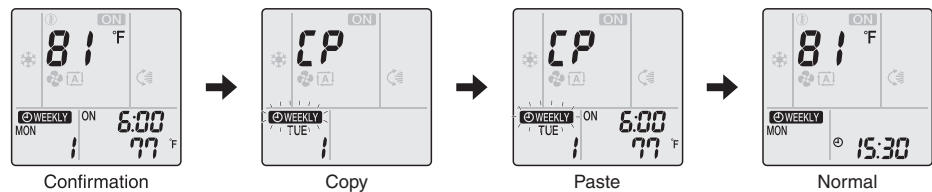

1. Press .
2. Press to confirm the day of the week to be copied.
3. Press .
 - The whole reservation of the selected day of the week will be copied.
4. Press to select the destination day of the week.
5. Press .
 - Check for a receiving tone and that the OPERATION lamp blinks twice.
 - The reservation will be copied to the selected day of the week. The whole reservation of the selected day of the week will be copied.
 - To continue copying the settings to other days of the week, repeat **STEP 4** and **STEP 5**.
6. Press to complete the setting.
 - “ WEEKLY” is displayed on the LCD and WEEKLY TIMER operation is activated.

NOTE

Note on COPY MODE

- The entire reservation of the source day of the week is copied in the copy mode.
In the case of making a reservation change for any day of the week individually after copying the content of weekly reservations, press and change the settings in the steps of **Setting mode** .

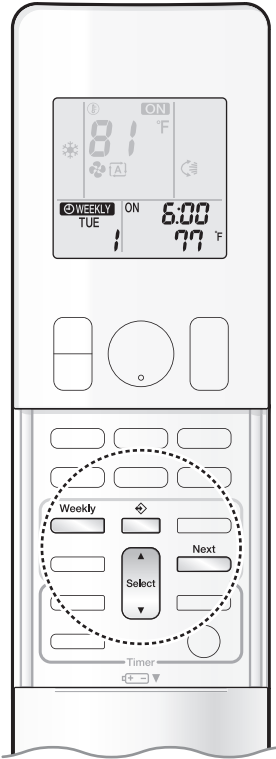

Confirming a reservation

- The reservation can be confirmed.

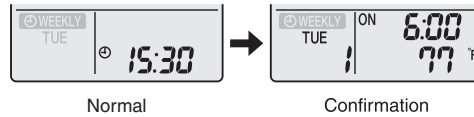

Setting Displays



1. Press .

- The day of the week and the reservation number of the current day will be displayed.

2. Press to select the day of the week and the reservation number to be confirmed.

- Pressing  displays the reservation details.
- To change the confirmed reserved settings, select the reservation number and press . The mode is switched to setting mode. Proceed to **Setting mode STEP 4**.

3. Press to exit the confirmation mode.

- “ WEEKLY” is displayed on the LCD and WEEKLY TIMER operation is activated.

To deactivate WEEKLY TIMER operation

Press while “ WEEKLY” is displayed on the LCD.

- “ WEEKLY” disappears from the LCD.
- The TIMER lamp goes off.
- To reactivate the WEEKLY TIMER operation, press  again.
- If a reservation deactivated with  is activated once again, the last reservation mode will be used.

NOTE

- If not all the reservation settings are reflected, deactivate the WEEKLY TIMER operation once. Then press  again to reactivate the WEEKLY TIMER operation.

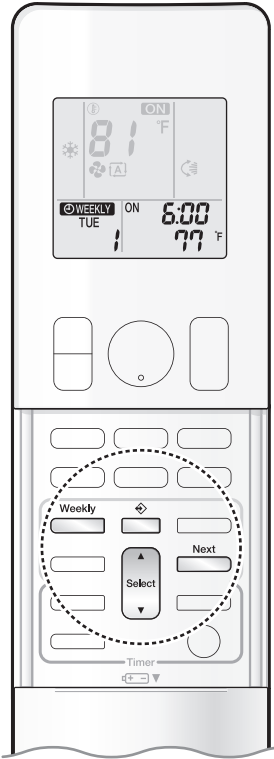

To delete reservations

An individual reservation

1. Press  .

- The day of the week and the reservation number will be displayed.

2. Press  **to select the day of the week and the reservation number to be deleted.**

3. Press  .

- “ WEEKLY” and “ON” or “OFF” blink.

4. Press  **until no icon is displayed.**

- Pressing  changes the ON/OFF TIMER mode in sequence.
- Selecting “blank” will cancel any reservation you may have.



Pressing  puts the sequence in reverse.

5. Press  .

- Check for a receiving tone and that the OPERATION lamp blinks twice.
- The selected reservation will be deleted.

6. Press  .

- If there are still other reservations, WEEKLY TIMER operation will be activated.

Reservations for each day of the week

- This function can be used for deleting reservations for each day of the week.
- It can be used while confirming or setting reservations.

1. Press  .

- The day of the week and the reservation number will be displayed.

2. Press  **to select the day of the week to be deleted.**

3. Hold  **for about 5 seconds.**

- Check for a receiving tone and that the OPERATION lamp blinks twice.
- The reservation of the selected day of the week will be deleted.

4. Press  .

- If there are still other reservations, WEEKLY TIMER operation will be activated.

All reservations

Hold  **for about 5 seconds with the normal display.**

- Check for a receiving tone and that the OPERATION lamp blinks twice.
- “ WEEKLY” disappears from the LCD.
- The TIMER lamp goes off.
- All reservations will be deleted.
- This operation is not functional while the WEEKLY TIMER setting screen is displayed.

1.16 Brightness Setting of Indoor Unit Display

Outline

The brightness of the indoor unit display can be adjusted as desired. Also, the display can be turned OFF.

Details

1. Press and hold **Menu** button for 2 seconds.
2. Press **Select ▲** or **Select ▼** button to select menu number **1**.
LED appears and **1** blinks.

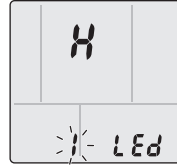

3. Press **Menu (push 2sec)** button to confirm the select setting.
4. Press **Select ▲** or **Select ▼** button to change the setting as follows:

R4003795

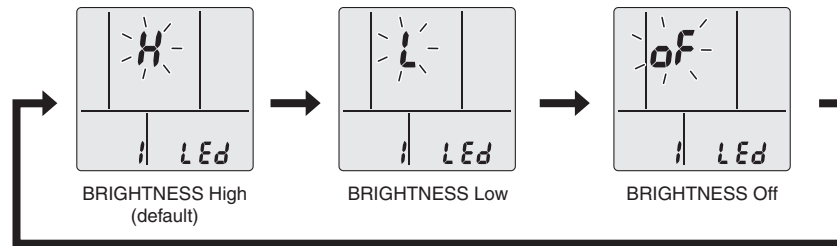

5. Press **Menu (push 2sec)** button again. Brightness will be set to the chosen value.
6. Press **Cancel** to return to the default screen.

R4003796



Note(s)

The display automatically returns to the default screen after 60 seconds. To return to the default screen sooner, press **Cancel** button twice.

1.17 CLEAN Operation

Outline

The CLEAN function dries the interior of the indoor unit to reduce the amount of condensation present. When COOL or DRY operation is performed, condensation may occur inside the air conditioner. It is recommended to dry the inside of the air conditioner using CLEAN operation.

Details

■ To operate automatically

1. Press and hold **Menu (push 2sec)** button for 2 seconds.
2. Press **Select ▲** or **Select ▼** button to select menu number 2.
Mold proof icon appears and 2 blinks.
3. Press **Menu (push 2sec)** button to confirm the select setting.
4. Press **Select ▲** or **Select ▼** button to change the setting as follows:

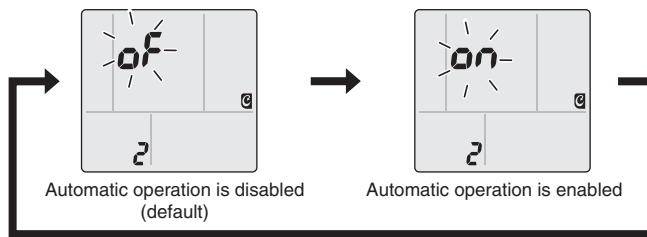

5. Press **Menu (push 2sec)** button again.
Automatic CLEAN operation will be enabled or disabled according to the chosen setting.
If automatic CLEAN operation is enabled, CLEAN icon appears on the LCD and the CLEAN PROOF lamp lights green when CLEAN operation is in progress.

R4003797

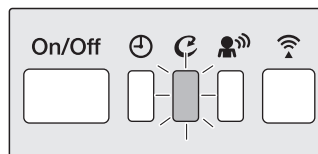

Display

6. Press **Cancel** to return to the default screen.

R4003798



Note(s)

Note on CLEAN setting

The display automatically returns to the default screen after 60 seconds. To return to the default screen sooner, press **Cancel** button twice.

Notes on CLEAN operation

- When you want to stop CLEAN operation midway, press **ON/OFF** button twice.
- After DRY or COOL operation stops, the air conditioner starts CLEAN operation automatically, and then stops automatically 140 minutes later.
- This operation dries the inside of the air conditioner using FAN operation and HEAT operation. The indoor temperature and humidity may not suit your preferences.
- The CLEAN function dries the interior of the indoor unit to reduce the amount of condensation present.
- CLEAN operation is not available when the unit is turned off using the OFF TIMER or turned off using a smartphone.
- The flaps may sometimes close to increase the drying effect inside the air conditioner.
- CLEAN operation automatically dries the inside of the air conditioner each time after COOL and DRY operation is stopped.
- CLEAN operation may not be performed if the COOL or DRY operation time is short.
- If CLEAN operation does not suit your preference, set operation to "OFF".

Relation between CLEAN operation and indoor unit lamps

Air conditioner	LCD	CLEAN lamp
Operating (OPERATION lamp lights up)	CLEAN is "ON"	Lights up
	CLEAN is "OFF"	Goes off
Not operating (OPERATION lamp goes off)	CLEAN is "ON"	Goes off
	CLEAN is "OFF"	Lights up (CLEAN is "Operating")
	CLEAN is "OFF"	Goes off

1.18 Wireless LAN Connection

Operation

Wireless LAN connection adapter

The Wireless LAN connection adapter function requires the Daikin Comfort Control App for connecting to the air conditioner and controlling it via your smartphone or tablet over your network.

Attention

- **Wireless LAN sends and receives data using radio waves so there is a risk of transmitted data being subject to eavesdropping and illegal access. When using wireless LAN, manage the SSID/KEY of the wireless LAN connection adapter, the SSID/KEY of the wireless router, and the app login information so that they will not be known to others, and ensure that you have an adequate understanding of the risks involved. In the case that the product is accessed and operated illegally, turn off the wireless LAN connection adapter function.**
- **Do not use this product near a microwave oven. (This can affect wireless LAN communications.)**
- **This product cannot be directly connected to the communication line of a telecommunications carrier (internet service provider, etc.). When connecting to the internet, be sure to connect via a device such as a router.**
When the wireless LAN connection adapter function is turned on, the right side of the air conditioner may become slightly warm, but this is not an abnormality.

[About the SSID and KEY]

- The [SSID] and [KEY] shown on the serial number sticker are necessary when connecting the air conditioner to a smartphone via wireless LAN.

! WARNING

- While the Wireless LAN connection adapter operates, it may affect persons using cardiac pacemakers or defibrillators. This product may cause electromagnetic interference.
- While the Wireless LAN connection adapter operates, it may affect automatic doors or fire alarm equipment. This product may cause faulty behavior of the equipment.

Configuration

- The user is responsible for providing the following items before using this product:
 - Smartphone or tablet PC
 - Internet line and communicating device (Modem/router or similar device)
 - Wireless LAN access point
 - Application name: [Daikin Comfort Control App] (free)
For details on the installation method for the Daikin Comfort Control App.

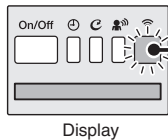

Wireless LAN connection adapter lamp (Orange)

- The Wireless LAN connection adapter lamp lights when connecting to a router (Wireless LAN access point).
- For Wireless LAN connection adapter operation.

! WARNING

When operating an air conditioner from outside the home, it is not possible to check the air conditioner or the surroundings of the air conditioner, or the state of the people in the room. Therefore, make sure to adequately check for safety before use.

In some cases, there is a risk of death, severe injury, or property damage.

■ Check the following in advance (while at home)

- Timer settings or reservations that other users may have made. (There is a risk of causing harm to the health of people, animals, or plants in the home if operation starts and stops unexpectedly)
- There are no signs of abnormality in the air conditioning. Harm will not be caused to people or to the room if there is a change in airflow. (For example, that there are no objects nearby that might blow over) (There is a risk of objects falling due to airflow and causing fire, bodily injury, or staining of household items)

■ Check the following before/while operating a unit from outside the home

- If you know that there is someone at home, inform the person when turning the air conditioner on or off from outside the home. (If someone at home is standing on something such as a stool, the air conditioner turning on or off unexpectedly could surprise them and cause them to fall or topple over. Additionally, a sudden change in the indoor/outdoor temperature could harm the health of people at home)
 - The air conditioner can be turned off and temperature adjustment can be made using a remote controller in the home.
 - Do not use the function if the only people at home are persons who are unable to make adjustments to temperature or other settings themselves, such as young children, disabled persons, or elderly persons.
- Regularly check the settings and operating status of the air conditioner. (Sudden changes in indoor/outdoor temperature pose a health hazard. There is a risk of harm to animals and plants)
If an error occurs during operation, immediately turn off the air conditioner and contact your dealer.
Double check the display to confirm that the power is off.

Wireless LAN connection



Web site: <https://daikincomfort.com/products/thermostats-controls/daikin-comfort-control-app>

For information on the latest version of Wireless LAN control, please see the web site above.

For instruction about how to operate the Daikin Comfort Control App application, please refer to the operation manual at the web site.

Contains FCC ID: VPYLB1YA

This device complies with part 15 of the FCC Rules. Operation is subject to the following two conditions:

- (1) This device may not cause harmful interference, and
- (2) This device must accept any interference received, including interference that may cause undesired operation.

FCC CAUTION

Changes or modifications not expressly approved by the party responsible for compliance could void the user's authority to operate the equipment. This transmitter must not be co-located or operated in conjunction with any other antenna or transmitter.

Contains IC: 772C-LB1YA

This device complies with Industry Canada's applicable licence-exempt RSSs.

Operation is subject to the following two conditions:

- (1) This device may not cause interference; and
- (2) This device must accept any interference, including interference that may cause undesired operation of the device.

This equipment complies with IC radiation exposure limits set forth for an uncontrolled environment and meets RSS-102 of the IC radio frequency (RF) Exposure rules. This equipment should be installed and operated keeping the radiator at least 7-7/8 inches (20cm) or more away from person's body. The FCC responsible party is Goodman Manufacturing Company, L.P., and may be contacted by calling (713)-861-2500, or at 19001 Kermier Rd., Waller, TX 77484.

(www.GoodmanMFG.com)

This device, which was assembled by Goodman manufacturing Company, L.P., contains a component that is classified as an intentional radiator.

This intentional radiator has been certified by the FCC: FCC ID VPYLB1YA.

And this intentional radiator has an industry Canada ID: IC 772C-LB1YA.

The manufacturer of the intentional radiator (model no. Type1YA) is Murata Manufacturing co., Ltd (www.murata.com).

This equipment complies with FCC radiation exposure limits set forth for an uncontrolled environment and meets the FCC radio frequency (RF) Exposure Guidelines. This equipment should be installed and operated keeping the radiator at least 7-7/8 inches (20cm) or more away from person's body.

Changes or modifications not expressly approved by the party responsible for compliance could void the user's authority to operate the equipment.

NOTE: This equipment has been tested and found to comply with the limits for a Class B digital device, pursuant to part 15 of the FCC Rules. These limits are designed to provide reasonable protection against harmful interference in a residential installation. This equipment generates, uses and can radiate radio frequency energy and, if not installed and used in accordance with the instructions, may cause harmful interference to radio communications. However, there is no guarantee that interference will not occur in a particular installation. If this equipment does cause harmful interference to radio or television reception, which can be determined by turning the equipment off and on, the user is encouraged to try to correct the interference by one or more of the following measures:

- Reorient or relocate the receiving antenna.
- Increase the separation between the equipment and receiver.
- Connect the equipment into an outlet on a circuit different from that to which the receiver is connected.
- Consult the dealer or an experienced radio/TV technician for help.

Application software installation

- Before downloading the application software for installing, please read "**Configuration**".

■ For Android Phones

- 1) Open [Google Play].
- 2) Search using the application name:
[Daikin Comfort Control App].
- 3) Follow the directions on the screen to install.

■ For iOS Phones

- 1) Open the [App Store].
- 2) Search using the application name:
[Daikin Comfort Control App].
- 3) Follow the directions on the screen to install.

Attention

- Stop the operation before setting the wireless connection.

To set

There are 2 options to connect the wireless LAN connection adapter with your smart device.

■ Connect the wireless LAN connection adapter to your home network.

The wireless LAN connection adapter will communicate with your smart device in your home network using a modem, router or a similar device.

■ Connect the wireless LAN connection adapter to your smart device directly.

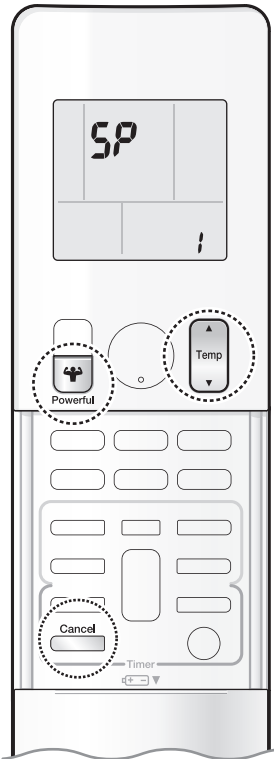

To confirm the wireless LAN connection adapter connection

■ To confirm

1. While operation is stopped, press  and hold the button for 5 seconds.

2. Press  to confirm the selected setting.

- “SP” appears on the LCD.
- “!” blinks.

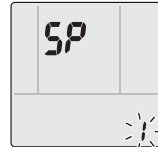

Check the indoor unit LED.

Wireless LAN connection adapter lamp	Status
Blinking for 1 second	Communication is OK
Blinking for 3 seconds	Please initialize the wireless LAN connection adapter
Does not blink or light	Communication is abnormal There is a possibility of equipment failure Please request repair

3. Press  to return to the default screen.

To connect the wireless LAN connection adapter to your home network

The wireless LAN connection adapter can be connected to your home network using:

- the WPS button on the router (if present)
- the SSID and KEY number on the unit.

■ To connect using the WPS button

1. While operation is stopped, press  and hold the button for 5 seconds.

2. Press  or  and select menu number **2**.

- “SP” appears on the LCD.
- “2” blinks.

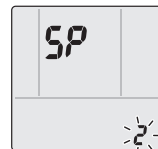

3. Press  to confirm the WPS selected setting.

- The wireless LAN connection adapter lamp blinks more quickly.

4. Press the WPS button on your communication device (router, for example) within approximately 1 minute. Refer to the manual of your communication device.

- The wireless LAN connection adapter lamp lights.

5. Press  to return to the default screen.

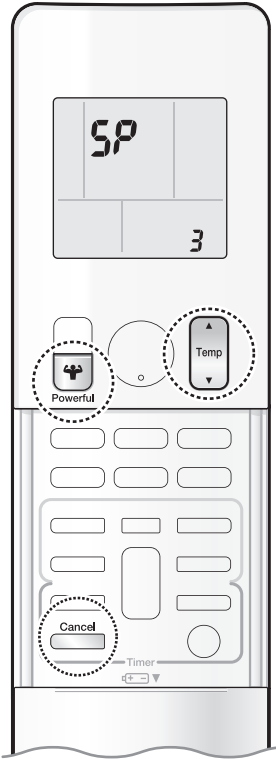

To connect the wireless LAN connection adapter to your smart device directly

■ **To connect without using the WPS function**

1. While operation is stopped, press  and hold the button for 5 seconds.

2. Press  or  and select menu number **3**.

- “SP” appears on the LCD.
- “3” blinks.

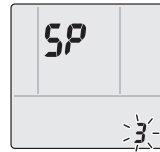

3. Press  to connect to the access point.

- The wireless LAN connection adapter lamp blinks for 1 second.

4. Connect with your smart device to the access point in the same way as to a standard wireless network.

- Select the SSID (DaikinAP*****) printed on the unit or in the accessory set, and enter the password.
- The wireless LAN connection adapter lamp lights.

5. Press  to return to the default screen.

6. Open the Daikin Comfort Control App and tap “Configure the wireless connection”, then connect to the home network following the instructions on the screen.

7. Connect your smartphone to the home network.

NOTE

Notes on wireless LAN operation

- If the wireless LAN connection adapter lamp lights, repeat steps 1 through 5.
If connection is still impossible, use the procedures in “[To reset the connection setting to the factory default](#)” to perform setting.
- If the LED display is distracting, change the brightness setting.

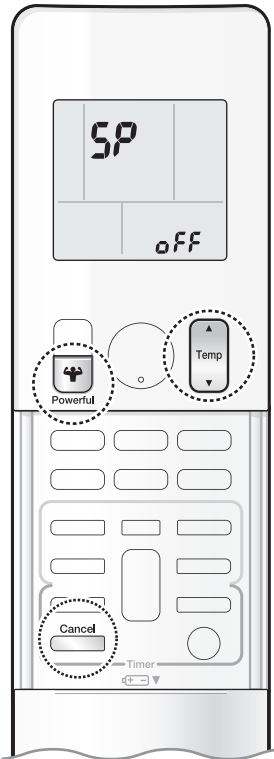

To turn off the wireless connection

■ To use the remote controller

1. While operation is stopped, press  and hold the button for 5 seconds.

2. Press  or  and select menu **OFF**.

- “SP” appears on the LCD.
- “OFF” blinks, and communication is OFF.



3. Press  and hold the button for 2 seconds to confirm selected setting.

- The wireless LAN connection adapter lamp turn off.

4. Press  to return to the default screen.

To reset the connection setting to the factory default

- If you want to reset the connection settings, it is possible to initialize the wireless LAN connection adapter to its factory default state. If initialized, data including the network settings and power consumption history will be erased.
- When discarding or transferring to another user, initialize the connection adapter to erase the internal data.

■ To reset

1. While operation is stopped, press  and hold the button for 5 seconds.

2. Press  or  and select menu **R**.

- “SP” appears on the LCD.
- “R” blinks.



3. Press  and hold the button for 2 seconds to confirm selected setting.

- The wireless LAN connection adapter lamp blinks for 1 second.

4. Press  to return to the default screen.

1.19 Other Functions

1.19.1 Hot-Start Function

In order to prevent the cold air blast that normally occurs when heating operation is started, the temperature of the indoor heat exchanger is detected, and the airflow is either stopped or significantly weakened resulting in comfortable heating.



Note(s)

The cold air blast is prevented using similar control when defrost control starts or when the thermostat is turned ON.

1.19.2 Signal Receiving Sign

When the indoor unit receives a signal from the remote controller, the unit emits a signal receiving sound.

1.19.3 Indoor Unit ON/OFF Switch

ON/OFF switch is provided on the display of the unit.

- Press **ON/OFF** switch once to start operation. Press once again to stop it.
- **ON/OFF** switch is useful when the remote controller is missing or the battery has run out.
- The operation mode refers to the following table.

Operation mode	Temperature setting	Airflow rate
AUTO	25°C (77°F)	Automatic

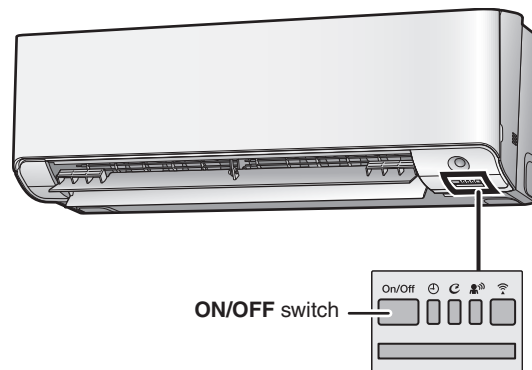

R4003799

Forced cooling operation

Forced cooling operation can be started by pressing **ON/OFF** switch for 5 ~ 9 seconds while the unit is not operating.

Refer to page 149 for details.



Note(s)

Forced cooling operation is not started if **ON/OFF** switch is pressed for 10 seconds or more.

1.19.4 Auto-restart Function

If a power failure (even a momentary one) occurs during the operation, the system restarts automatically in the same conditions as before when the power supply is restored to the conditions prior to the power failure.



Note

It takes 3 minutes to restart the operation because 3-minute standby function is activated.

2. Thermistor Functions

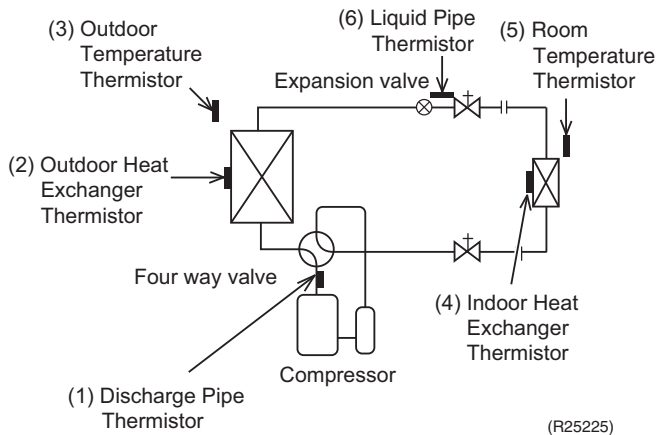

(1) Discharge Pipe Thermistor

- The discharge pipe thermistor is used for controlling discharge pipe temperature. If the discharge pipe temperature (used in place of the inner temperature of the compressor) rises abnormally, the operating frequency becomes lower or the operation halts.
- The discharge pipe thermistor is used for detecting disconnection of the discharge pipe thermistor.

(2) Outdoor Heat Exchanger Thermistor

- The outdoor heat exchanger thermistor is used for controlling the target discharge pipe temperature. The system sets the target discharge pipe temperature according to the outdoor and indoor heat exchanger temperature, and controls the electronic expansion valve opening so that the target discharge pipe temperature can be obtained.
- In cooling operation, the outdoor heat exchanger thermistor is used for detecting the disconnection of the discharge pipe thermistor. When the discharge pipe temperature drops below the outdoor heat exchanger temperature by more than a certain value, the discharge pipe thermistor is judged as disconnected.
- In cooling operation, the outdoor heat exchanger thermistor is used for high pressure protection.

(3) Outdoor Temperature Thermistor

- The outdoor temperature thermistor detects the outdoor air temperature and is used for refrigerant shortage detection, input current control, outdoor fan control, liquid compression protection function, and so on.

(4) Indoor Heat Exchanger Thermistor

- The indoor heat exchanger thermistor is used for controlling the target discharge pipe temperature. The system sets the target discharge pipe temperature according to the outdoor and indoor heat exchanger temperature, and controls the electronic expansion valve opening so that the target discharge pipe temperature can be obtained.
- In cooling operation, the indoor heat exchanger thermistor is used for freeze-up protection control. If the indoor heat exchanger temperature drops abnormally, the operating frequency becomes lower or the operation halts.
- In heating operation, the indoor heat exchanger thermistor is used for detecting the disconnection of the discharge pipe thermistor. When the discharge pipe temperature drops below the indoor heat exchanger temperature by more than a certain value, the discharge pipe thermistor is judged as disconnected.

(5) Room Temperature Thermistor

- The room temperature thermistor detects the room air temperature and is used for controlling the room air temperature.
-

(6) Liquid Pipe Thermistor

- The liquid pipe thermistor is used for control in hybrid cooling. The microcomputer sets the target liquid pipe temperature and controls the electronic expansion valve opening so that the temperature from the liquid pipe thermistor becomes the target temperature.

3. Control Specification

3.1 Mode Hierarchy

Outline

The air conditioner control has normal operation mode, forced operation mode, and power transistor test mode for installation and servicing.

Details

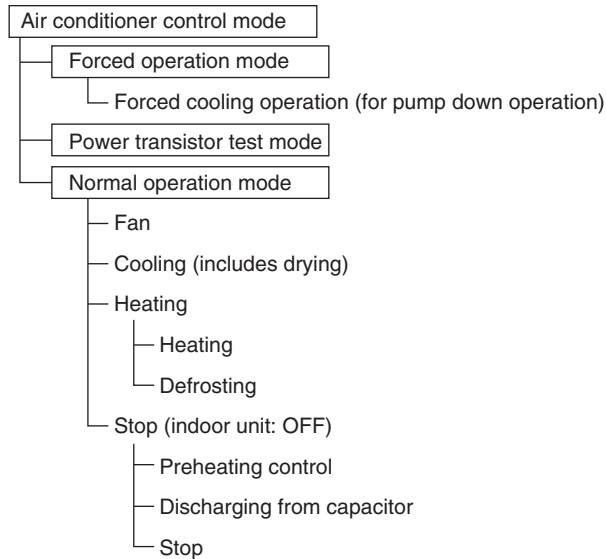

(R22375)



Note(s) Unless specified otherwise, dry operation command is regarded as cooling operation.

3.2 Frequency Control

Outline

The compressor frequency is determined according to the difference between the room thermistor temperature and the target temperature.

When the shift of the frequency is less than zero ($\Delta F < 0$) by PI control, the target frequency is used as the command frequency.

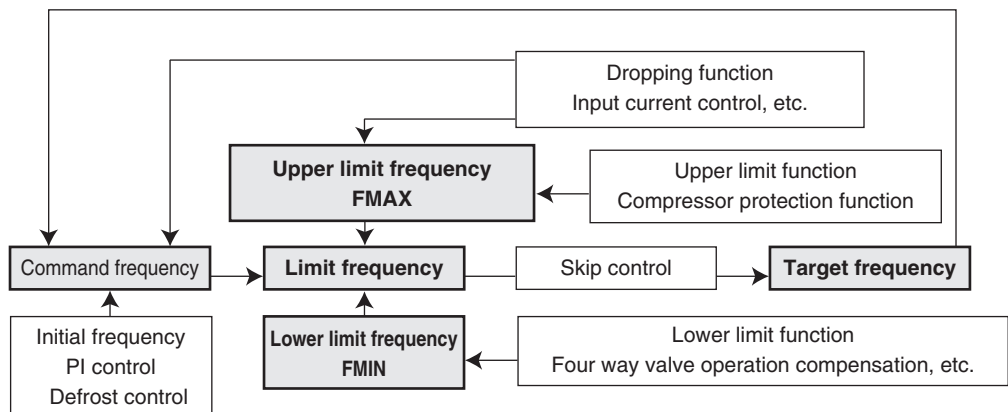

(R18023)

Details**1. Determine command frequency**

Command frequency is determined in the following order of priority.

- (1) Limiting defrost control time
- (2) Forced cooling
- (3) Indoor frequency command

2. Determine upper limit frequency

The minimum value is set as an upper limit frequency among the frequency upper limits of the following functions:

Compressor protection, input current, discharge pipe temperature, heating peak-cut, freeze-up protection, defrost control.

3. Determine lower limit frequency

The maximum value is set as a lower limit frequency among the frequency lower limits of the following functions:

Four way valve operation compensation, draft prevention, pressure difference upkeep.

4. Determine prohibited frequency

There is a certain prohibited frequency such as a power supply frequency.

Initial Frequency

When starting the compressor, the frequency is initialized according to the ΔD value of the indoor unit.

 ΔD signal: Indoor frequency command

The difference between the room thermistor temperature and the target temperature is taken as the ΔD value and is used for ΔD signal of frequency command.

 ΔD signal for cooling

Temperature difference	ΔD signal	Temperature difference	ΔD signal	Temperature difference	ΔD signal
-2.0°C (-3.6°F)	*OFF	0°C (0°F)	4	2.0°C (3.6°F)	8
-1.5°C (-2.7°F)	1	0.5°C (0.9°F)	5	2.5°C (4.5°F)	9
-1.0°C (-1.8°F)	2	1.0°C (1.8°F)	6	—	—
-0.5°C (-0.9°F)	3	1.5°C (2.7°F)	7	—	—

*OFF = Thermostat OFF

 ΔD signal for heating

Temperature difference	ΔD signal	Temperature difference	ΔD signal	Temperature difference	ΔD signal
-2.0°C (-3.6°F)	*OFF	0°C (0°F)	4	2.0°C (3.6°F)	8
-1.5°C (-2.7°F)	1	0.5°C (0.9°F)	5	2.5°C (4.5°F)	9
-1.0°C (-1.8°F)	2	1.0°C (1.8°F)	6	3.0°C (5.4°F)	10
-0.5°C (-0.9°F)	3	1.5°C (2.7°F)	7	3.5°C (6.3°F)	11

*OFF = Thermostat OFF

PI Control**1. P control**

The ΔD value is calculated in each sampling time (20 seconds), and the frequency is adjusted according to its difference from the frequency previously calculated.

2. I control

If the operating frequency does not change for more than a certain fixed time, the frequency is adjusted according to the ΔD value.

When ΔD value is low, the frequency is lowered.

When ΔD value is high, the frequency is increased.

3. Frequency control when other controls are functioning

- When frequency is dropping:
Frequency control is carried out only when the frequency drops.
- For limiting lower limit:
Frequency control is carried out only when the frequency rises.

4. Upper and lower limit of frequency by PI control

The frequency upper and lower limits are set according to the command of the indoor unit.

When the indoor or outdoor unit quiet operation command comes from the indoor unit, the upper limit frequency is lower than the usual setting.

3.3 Standby Electricity Saving (Suspend Function)

Outline

This function is to save standby electricity consumption while the air conditioner is not in operation by partially separating the electrical circuit of indoor and outdoor units from the power source.

Details

- Standby electricity saving function can be activated/deactivated from the service mode of the remote controller. Refer to page 155 for details.
- When standby electricity saving is ON, the system enters suspend state if both indoor and outdoor units are not in operation.
- The system will not go into suspend state when some voltage is applied to the outdoor unit for protection purpose even if the indoor unit is not in operation.
- In suspend state, power supply to the outdoor unit is halted and there is no communication between the indoor unit and the outdoor unit.
Also the service monitor LED (LED A) lights off.
- To return from the suspend state, start fan or other operation to turn on the indoor unit.

3.4 Controls at Mode Changing/Start-up

3.4.1 Preheating Control

Applicable Models

RXM18/24VVJU

Outline

The inverter operation in open phase starts with the conditions of the preheating command from the indoor unit, the outdoor temperature, the discharge pipe temperature, and the radiation fin temperature.

Details

ON Condition

- Outdoor temperature < **A**°C
- Discharge pipe temperature < (outdoor temperature + **B**)°C

OFF condition

- Outdoor temperature > **C**°C
- Discharge pipe temperature > (outdoor temperature + **D**)°C

A		B		C		D	
(°C)	(°F)	(°C)	(°F)	(°C)	(°F)	(°C)	(°F)
18	64	10 ~ 18	50 ~ 64	22	72	12 ~ 20	54 ~ 68

3.4.2 Four Way Valve Switching

Outline

The four way valve coil is energized/not energized depending on the operation mode.

(Heating: ON, Cooling/Dry/Defrost: OFF)

In order to eliminate the switching sound as the four way valve coil switches from ON to OFF when the heating is stopped, the OFF delay switch of the four way valve is carried out.

Details

OFF delay switch of four way valve

The four way valve coil is energized for 160* seconds after the operation is stopped.

*10 seconds in heating operation when the outdoor temperature is lower than -9 °C (15.8°F)

3.4.3 Four Way Valve Operation Compensation

Outline

At the beginning of operation as the four way valve is switched, the pressure difference to activate the four way valve is acquired when the output frequency is higher than a certain fixed frequency, for a certain fixed time.

Details

Starting Conditions

- When the compressor starts and the four way valve switches from OFF to ON
- When the four way valve switches from ON to OFF during operation
- When the compressor starts after resetting
- When the compressor starts after the fault of four way valve switching

The lower limit of frequency keeps **A** Hz for **B** seconds for any of the conditions above.

	09/12 class		18/24 class	
	Cooling	Heating	Cooling	Heating
A (Hz)	46	36	28	30
B (seconds)	60	60	70	70

3.4.4 3-Minute Standby

Turning on the compressor is prohibited for 3 minutes after turning off.
The function is not used when defrosting.

3.4.5 Compressor Protection Function

When turning the compressor from OFF to ON, the upper limit of frequency is set as follows. (The function is not used when defrosting.)

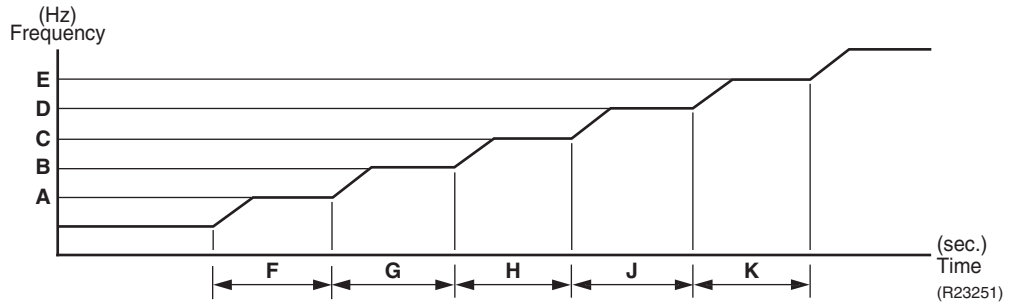

	09/12 class		18/24 class	
	Cooling	Heating	Cooling	Heating
A (Hz)	36	36	48	48
B (Hz)	52	52	48	48
C (Hz)	68	68	62	62
D (Hz)	80	80	80	80
E (Hz)	110	110	—	—
F (sec)	120	120	100	100
G (sec)	120	120	800	800
H (sec)	480	480	300	300
J (sec)	180	180	470	470
K (sec)	600	600	—	—

3.5 Discharge Pipe Temperature Control

Outline

The discharge pipe temperature is used as the internal temperature of the compressor. If the discharge pipe temperature rises above a certain level, the upper limit of frequency is set to keep the discharge pipe temperature from rising further.

Details

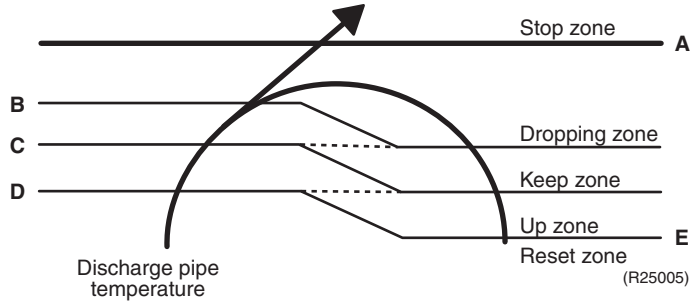

Zone	Control
Stop zone	When the temperature reaches the stop zone, the compressor stops.
Dropping zone	The upper limit of frequency decreases.
Keep zone	The upper limit of frequency is kept.
Up zone	The upper limit of frequency increases.
Reset zone	The upper limit of frequency is canceled.

	(°C)	(°F)
A	118	244
B	108	226
C	103	217
D	97	207
E	85	185

3.6 Input Current Control

Outline

The microcomputer calculates the input current while the compressor is running, and sets the frequency upper limit based on the input current.

In case of heat pump models, this control is the upper limit control of the frequency and takes priority over the lower limit control of four way valve operation compensation.

Details

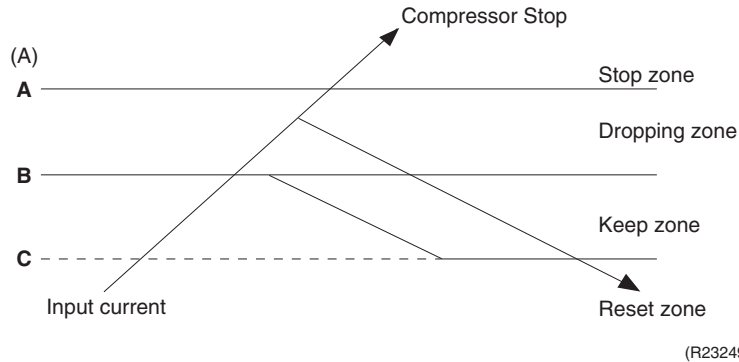

Frequency control in each zone

Stop zone

- After the input current remains in the stop zone for 2.5 seconds, the compressor is stopped.

Dropping zone

- The upper limit of the compressor frequency is defined as operation frequency – 2 Hz.
- After this, the output frequency is lowered by 2 Hz every second until it reaches the keep zone.

Keep zone

- The present maximum frequency goes on.

Reset zone

- Limit of the frequency is canceled.

	09/12 class		18 class		24 class	
	Cooling	Heating	Cooling	Heating	Cooling	Heating
A (A)	13.0	13.0	20.0	20.0	20.0	20.0
B (A)	11.5	12.0	16.25	18.25	18.0	19.25
C (A)	10.5	11.0	15.25	17.25	17.0	18.25

Limitation of current dropping and stop value according to the outdoor temperature

The current drops when outdoor temperature becomes higher than a certain level (depending on the model).

3.7 Freeze-up Protection Control

Outline

During cooling operation, the signal sent from the indoor unit determines the frequency upper limit and prevents freezing of the indoor heat exchanger. The signals from the indoor unit are divided into zones.

Details

The operating frequency limitation is judged with the indoor heat exchanger temperature.

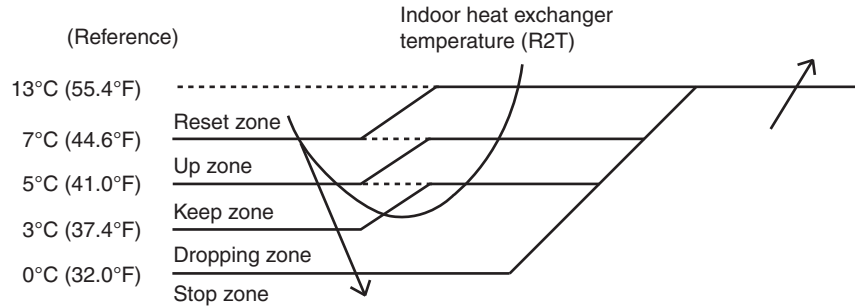

R4003644

3.8 Heating Peak-cut Control

During heating operation, the indoor heat exchanger temperature determines the frequency upper limit to prevent abnormal high pressure.

The operating frequency limitation is judged with the indoor heat exchanger temperature.

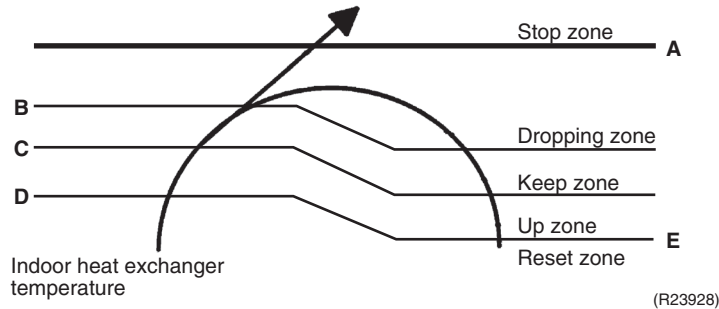

(R23928)

Zone	Control
Stop zone	When the temperature reaches the stop zone, the compressor stops.
Dropping zone	The upper limit of frequency decreases.
Keep zone	The upper limit of frequency is kept.
Up zone	The upper limit of frequency increases.
Reset zone	The upper limit of frequency is canceled.

	09/12 class		18/24 class	
	(°C)	(°F)	(°C)	(°F)
A	62	144	60	140
B	54	129	54	129
C	50	122	51	124
D	48	118	49	120
E	44	111	44	111

3.9 High Pressure Protection Control

Outline

In order to prevent abnormal high pressures in the system and hence avoiding activation of the high pressure safety device the below control function will be activated.

Details

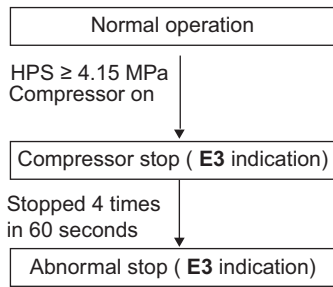
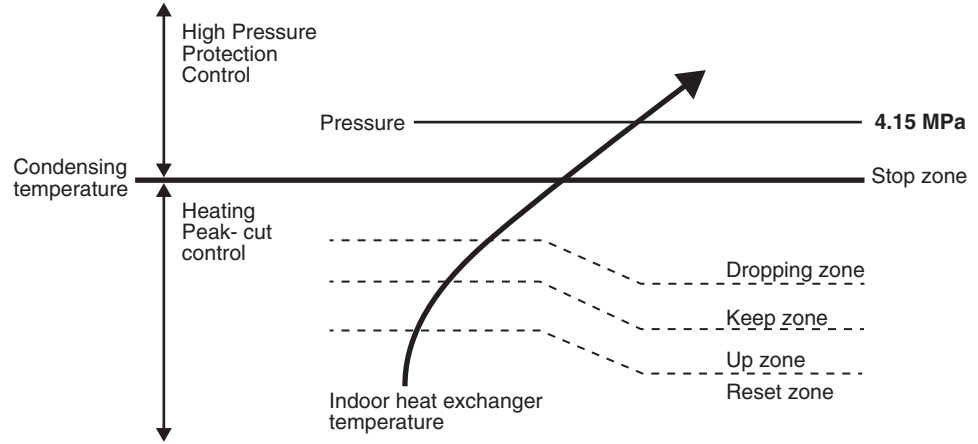

3.10 Outdoor Fan Control

1. **Fan ON control to cool down the electrical box**
The outdoor fan is turned ON when the electrical box temperature is high while the compressor is OFF.
2. **Fan OFF control during defrosting**
The outdoor fan is turned OFF while defrosting.
3. **Fan OFF delay when stopped**
The outdoor fan is turned OFF 60 ~ 70 seconds after the compressor stops.
4. **Fan speed control for pressure difference upkeep**
The rotation speed of the outdoor fan is controlled for keeping the pressure difference during cooling operation with low outdoor temperature.
 - When the pressure difference is low, the rotation speed of the outdoor fan is reduced.
 - When the pressure difference is high, the rotation speed of the outdoor fan is controlled as well as normal operation.
5. **Fan speed control during forced operation**
The outdoor fan is controlled as well as normal operation during forced operation.
6. **Fan speed control during POWERFUL operation**
The rotation speed of the outdoor fan is increased during POWERFUL operation.
7. **Fan speed control during indoor/outdoor unit quiet operation**
The rotation speed of the outdoor fan is reduced by the command of the indoor/outdoor unit quiet operation.
8. **Fan ON/OFF control when operation (cooling, heating, dry) starts/stops**
The outdoor fan is turned ON when the operation starts. The outdoor fan is turned OFF when the operation stops.

3.11 Liquid Compression Protection Function

Outline

The compressor stops according to the outdoor temperature for protection.

Details

Operation stops depending on the outdoor temperature.

The compressor turns off under the conditions that the system is in cooling operation and the outdoor temperature is below 0°C (32°F).

3.12 Defrost Control

Outline

Defrosting is carried out by the cooling cycle (reverse cycle). The defrosting time or outdoor heat exchanger temperature must be more than a certain value to finish defrosting.

Details

Conditions for Starting Defrost

- The starting conditions are determined with the outdoor temperature and the outdoor heat exchanger temperature.
- The system is in heating operation.
- The compressor operates for 6 minutes.
- More than **A** minutes (depending on the duration of the previous defrost control) of accumulated time have passed after the start of the operation, or ending the previous defrosting.

Conditions for Canceling Defrost

The judgment is made with the outdoor heat exchanger temperature. (**B**°C)

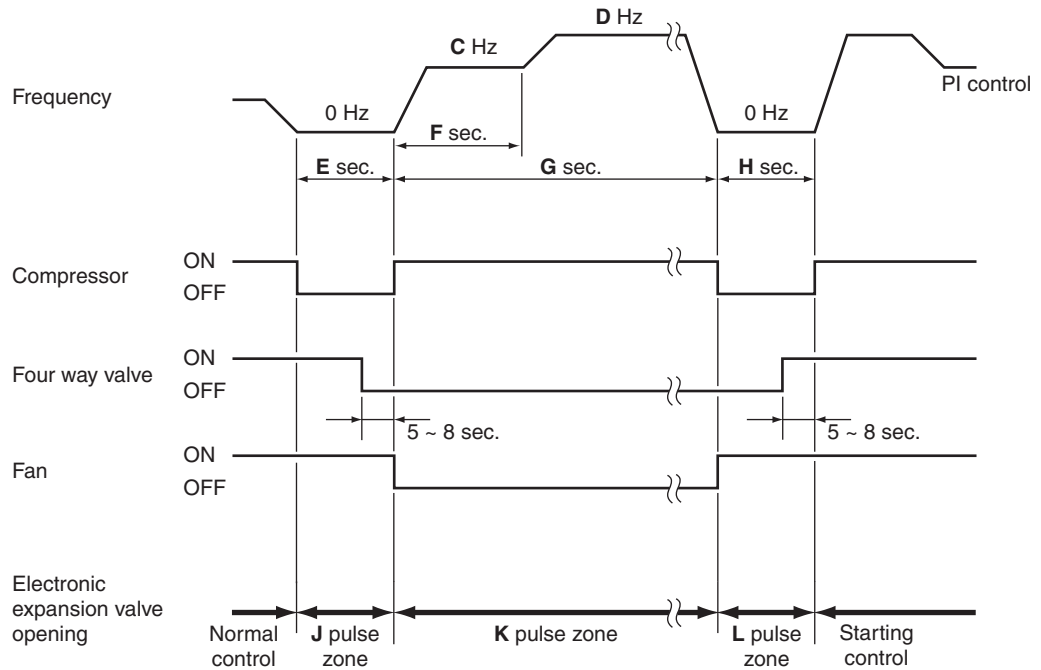

(R21278)

	09/12 class	18/24 class
A (minutes)	15 ~ 25	48
B	(°C)	6 ~ 11.5
	(°F)	43 ~ 53
C (Hz)	48	48
D (Hz)	80	62
E (seconds)	35	60
F (seconds)	60	60
G (seconds)	120 ~ 570	120 ~ 460
H (seconds)	75	60
J (pulse)	470	450
K (pulse)	400 ~ 444	490
L (pulse)	402	400

3.13 Electronic Expansion Valve Control

Outline

The following items are included in the electronic expansion valve control.

Electronic expansion valve is fully closed

1. Electronic expansion valve is fully closed when turning on the power.
2. Pressure equalizing control

Open Control

1. Electronic expansion valve control when starting operation
2. Electronic expansion valve control when the frequency changes
3. Electronic expansion valve control for defrosting
4. Electronic expansion valve control when the discharge pipe temperature is abnormally high
5. Electronic expansion valve control when the discharge pipe thermistor is disconnected

Feedback Control

Target discharge pipe temperature control

Details

The followings are the examples of electronic expansion valve control for each operation mode.

<div style="text-align: center;">Status</div> <div style="text-align: center;">Control</div>	Power on ; Compressor stop	Operation start	Frequency change under starting control	During target discharge pipe temperature control	Frequency change under target discharge pipe temperature control	Discharge pipe thermistor disconnection	Frequency change under discharge pipe thermistor disconnection control	During defrost control
Starting operation control	—	●	—	—	—	—	—	—
Control when the frequency changes	—	—	●	—	●	—	—	—
Target discharge pipe temperature control	—	—	—	●	—	—	—	—
Discharge pipe thermistor disconnection control	—	—	—	—	—	●	●	—
High discharge pipe temperature control	—	●	●	●	●	—	—	—
Defrost control (heating only)	—	—	—	—	—	—	—	●
Pressure equalizing control	●	—	—	—	—	—	—	—
Opening limit control	—	●	●	●	●	●	●	—

● : Available
 — : Not available

R4003560

3.13.1 Initialization as Power Supply On

The electronic expansion valve is initialized (fully closed) when the power is turned on. Then, the valve opening position is set and the pressure is equalized.

3.13.2 Pressure Equalizing Control

When the compressor is stopped, the pressure equalizing control is activated. The electronic expansion valve opens, and develops the pressure equalization.

3.13.3 Opening Limit Control

The maximum and minimum opening of the electronic expansion valve are limited.

	09/12 class	18/24 class
Maximum opening (pulse)	470	490
Minimum opening (pulse)	30	40

The electronic expansion valve is fully closed when cooling operation stops, and is controlled at a fixed opening during defrosting.

3.13.4 Starting Operation Control

The electronic expansion valve opening is controlled when the operation starts, thus preventing superheating or liquid compression.

3.13.5 Control when the Frequency Changes

When the target discharge pipe temperature control is active, if the target frequency changes to a specified value in a certain time period, the target discharge pipe temperature control is canceled and the target opening of the electronic expansion valve is changed according to the frequency shift.

3.13.6 High Discharge Pipe Temperature Control

When the compressor is operating, if the discharge pipe temperature exceeds a certain value, the electronic expansion valve opens and the refrigerant runs to the low pressure side.

This procedure lowers the discharge pipe temperature.

3.13.7 Discharge Pipe Thermistor Disconnection Control

Outline

The disconnection of the discharge pipe thermistor is detected by comparing the discharge pipe temperature with the condensing temperature. If the discharge pipe thermistor is disconnected, the electronic expansion valve opens according to the outdoor temperature and the operation frequency, operates for a specified time, and then stops.

After 3 minutes, the operation restarts and checks if the discharge pipe thermistor is disconnected. If the discharge pipe thermistor is disconnected, the system stops after operating for a specified time.

If the disconnection is detected repeatedly, the system is shut down. When the compressor runs for 60 minutes without any error, the error counter is reset.

Details

Determining thermistor disconnection

When the starting control (Cooling: **A** seconds, Heating: **B** seconds) finishes, the detection timer for disconnection of the discharge pipe thermistor (**C** seconds) starts. When the timer is over, the following adjustments are made.

1. When the operation mode is cooling
When the following condition is fulfilled, the discharge pipe thermistor disconnection is ascertained.
(Discharge pipe temperature + **D**) °C < (outdoor heat exchanger temperature)
2. When the operation mode is heating
When the following condition is fulfilled, the discharge pipe thermistor disconnection is ascertained.
(Discharge pipe temperature + **D**) °C < (indoor heat exchanger temperature)

When the thermistor is disconnected

When the disconnection is ascertained, the compressor continues operation for 9 minutes and then stops.

If the compressor stops repeatedly, the system is shut down.

		09/12 class	18/24 class
A (seconds)		1	30
B (seconds)		1	30
C (seconds)		720 ^{*1}	1020 ^{*2}
D	(°C)	6	6
	(°F)	42.8	42.8

*1 1200 seconds: in heating operation when the outdoor temperature is lower than -10°C (14°F)

*2 1800 seconds: in heating operation when the outdoor temperature is lower than -15°C (5°F)

3.13.8 Target Discharge Pipe Temperature Control

The target discharge pipe temperature is obtained from the indoor and outdoor heat exchanger temperature, and the electronic expansion valve opening is adjusted so that the actual discharge pipe temperature becomes close to the target discharge pipe temperature. (Indirect SH (superheating) control using the discharge pipe temperature)

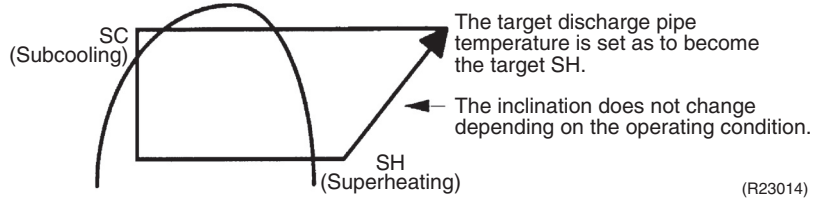

(R23014)

The electronic expansion valve opening and the target discharge pipe temperature are adjusted every 20 seconds. The opening degree of the electronic expansion valve is adjusted by the following.

- Target discharge pipe temperature
- Actual discharge pipe temperature
- Previous discharge pipe temperature

3.14 Malfunctions

3.14.1 Sensor Malfunction Detection

Sensor malfunction can be detected in the following thermistor:

1. Outdoor heat exchanger thermistor
2. Discharge pipe thermistor
3. Radiation fin thermistor
4. Outdoor temperature thermistor

3.14.2 Detection of Overcurrent and Overload

Outline

In order to protect the inverter, an excessive output current is detected and the OL temperature is observed to protect the compressor.

Details

- If the inverter current exceeds **A** A, the system shuts down the compressor.
- If the OL (Compressor head) temperature exceeds **B**°C (°F), the compressor stops.

	09/12 class		18 class		24 class	
	Cooling	Heating	Cooling	Heating	Cooling	Heating
A (A)	13.0	13.0	20	20	20	20
B	(°C)	125	125	125	125	125
	(°F)	257	257	257	257	257

Part 5 Remote Controller

1. Applicable Remote Controller	77
2. ARC466A70	78
3. ARC466A71	80

1. Applicable Remote Controller

Series	Model Name	Remote Controller	Reference Page
FTXM-V	FTXM09VVJU	ARC466A70	78
	FTXM12VVJU		
	FTXM18VVJU	ARC466A71	80
	FTXM24VVJU		

**Note**

Refer to the operation manual of applicable model for details. You can download operation manuals from Daikin Business Portal:

Daikin Business Portal → Document Search → Item Category → Installation/Operation Manual
(URL: https://global1d.daikin.com/business_portal/login/)

2. ARC466A70

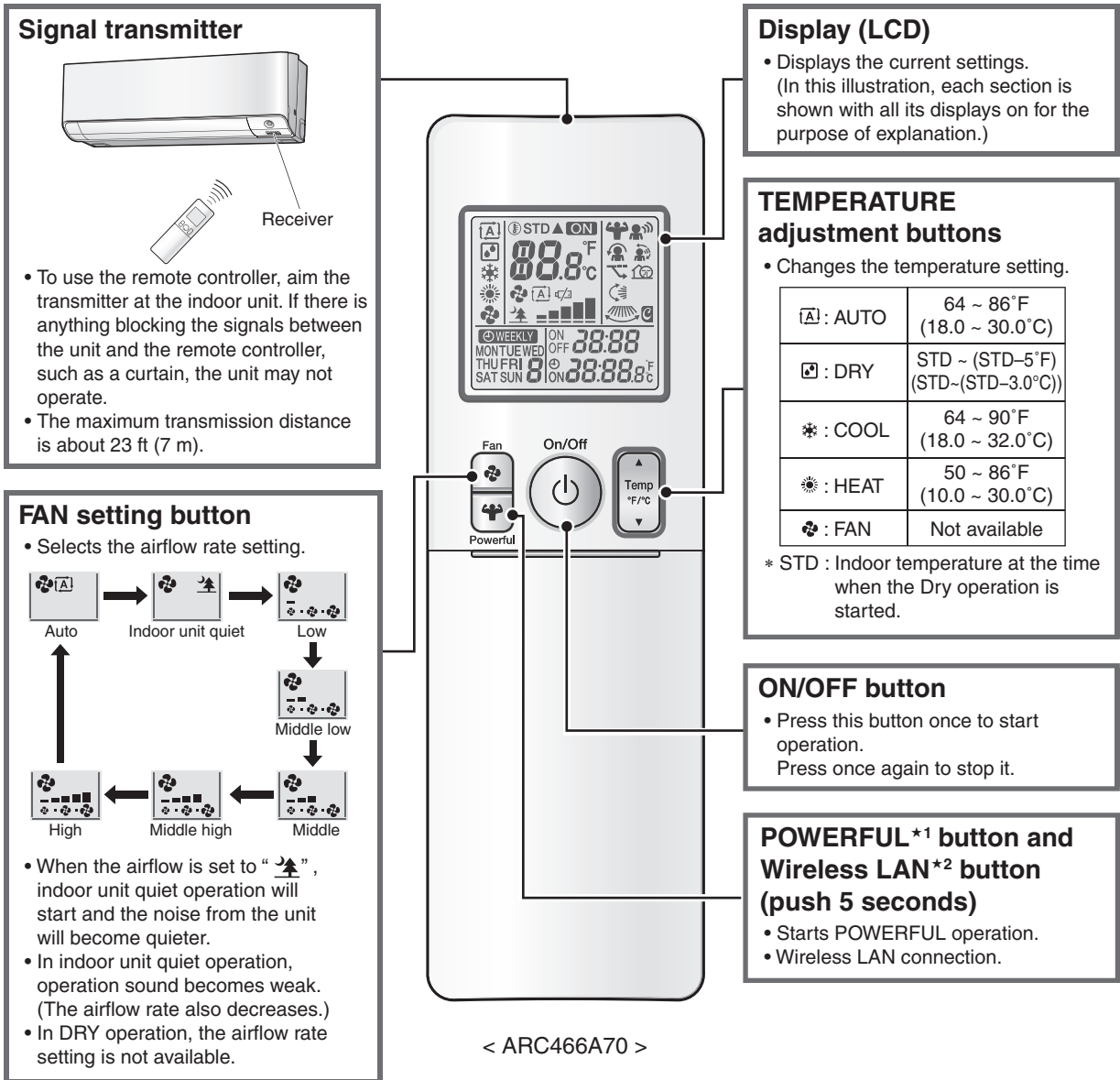

Reference Refer to the following pages for details.

- ★1 POWERFUL Operation P.42
- ★2 Wireless LAN Connection P.53

Open the Front Cover

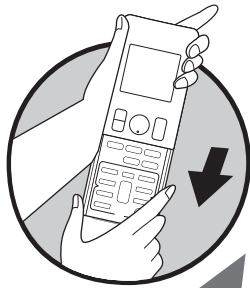

Mode button

• Selects the operation mode.



ECONO*5 /QUIET button

• Every time you press **ECONO/QUIET** button, the setting changes in the following order.

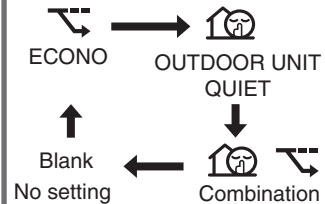

• **OUTDOOR UNIT QUIET** operation is not available in **FAN** and **DRY** operation.
 • **OUTDOOR UNIT QUIET** operation and **POWERFUL** operation cannot be used at the same time. Priority is given to the function you pressed last.

SENSOR button (INTELLIGENT EYE Operation*3)

• Every time you press **Sensor** button, the setting changes in the following order.
 • The **INTELLIGENT EYE** lamp lights green.

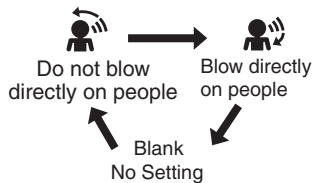

COMFORT*4 button

• Starts **COMFORT AIRFLOW** operation.

OFF TIMER button (NIGHT SET mode)

• Press this button and adjust the day and time with **SELECT** button. Press this button again to complete **TIMER** setting.

TIMER CANCEL button

• Cancels the timer setting.
 • It cannot be used for **WEEKLY TIMER** operation.

CLOCK*8 button

ON TIMER button

• Press this button and adjust the day and time with **SELECT** button. Press this button again to complete **TIMER** setting.

SELECT button

• Changes the clock, **ON/OFF** **TIMER** and **WEEKLY** **TIMER** settings.

SWING*6 buttons and MENU button (push 2 seconds)

• Adjusts the airflow direction.
 • When you press **SWING** button, the flap moves up and down, or (and) the louver moves right and left. The flap (louver) stops when you press **SWING** button again.
 • Adjusts the display brightness.
 • **MOLD PROOF** operation.
 • Flash streamer air cleaning operation.

WEEKLY buttons (WEEKLY TIMER*7 Operation)

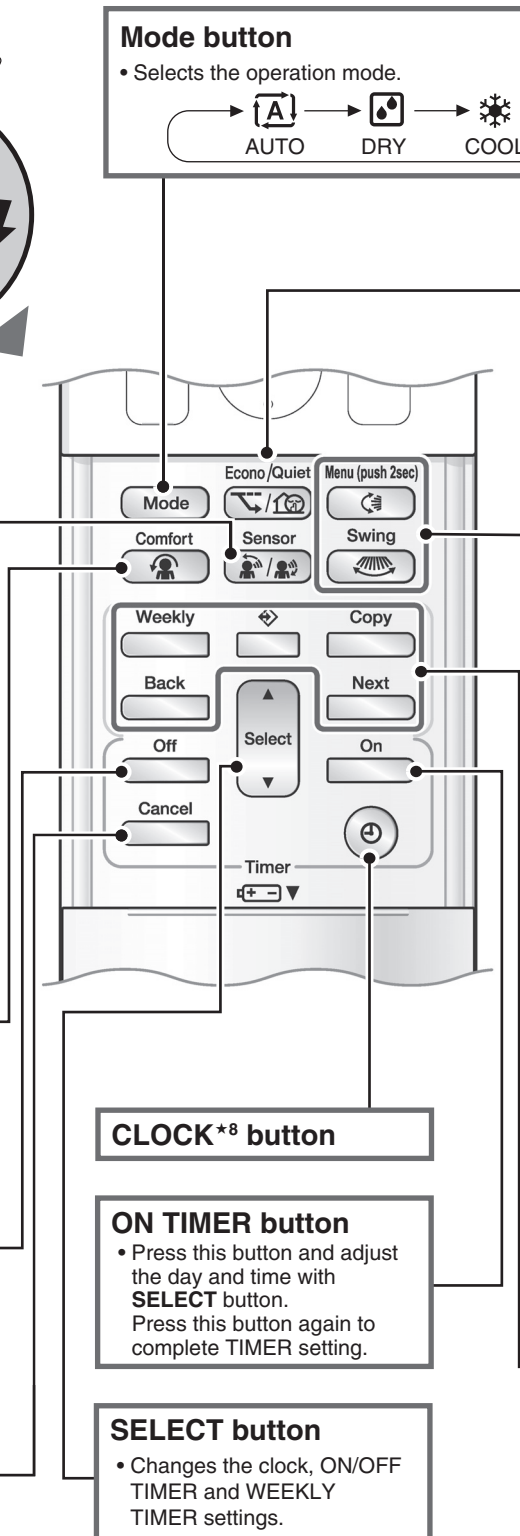
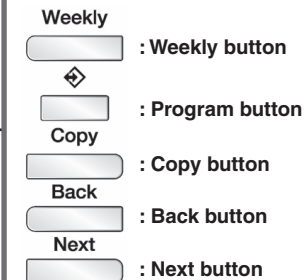

Reference Refer to the following pages for details.

★3 2-area INTELLIGENT EYE operation	P.36	★6 Auto-swing	P.26
★4 COMFORT AIRFLOW operation	P.27	★7 WEEKLY TIMER operation	P.44
★5 ECONO operation	P.35	★8 Clock setting	P.43

3. ARC466A71

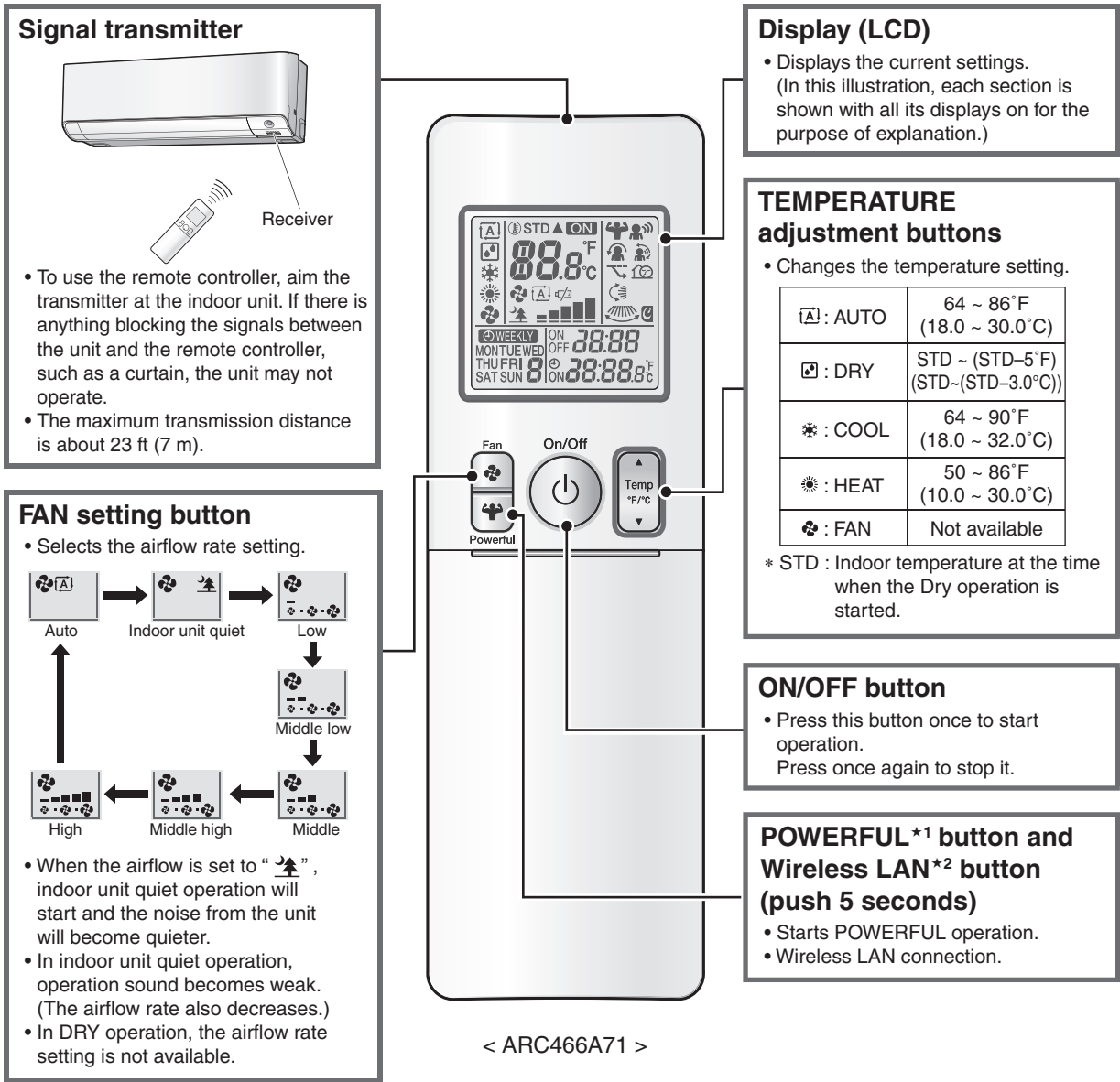

Reference Refer to the following pages for details.

- ★1 POWERFUL operation P.42
- ★2 Wireless LAN connection P.53

Open the Front Cover

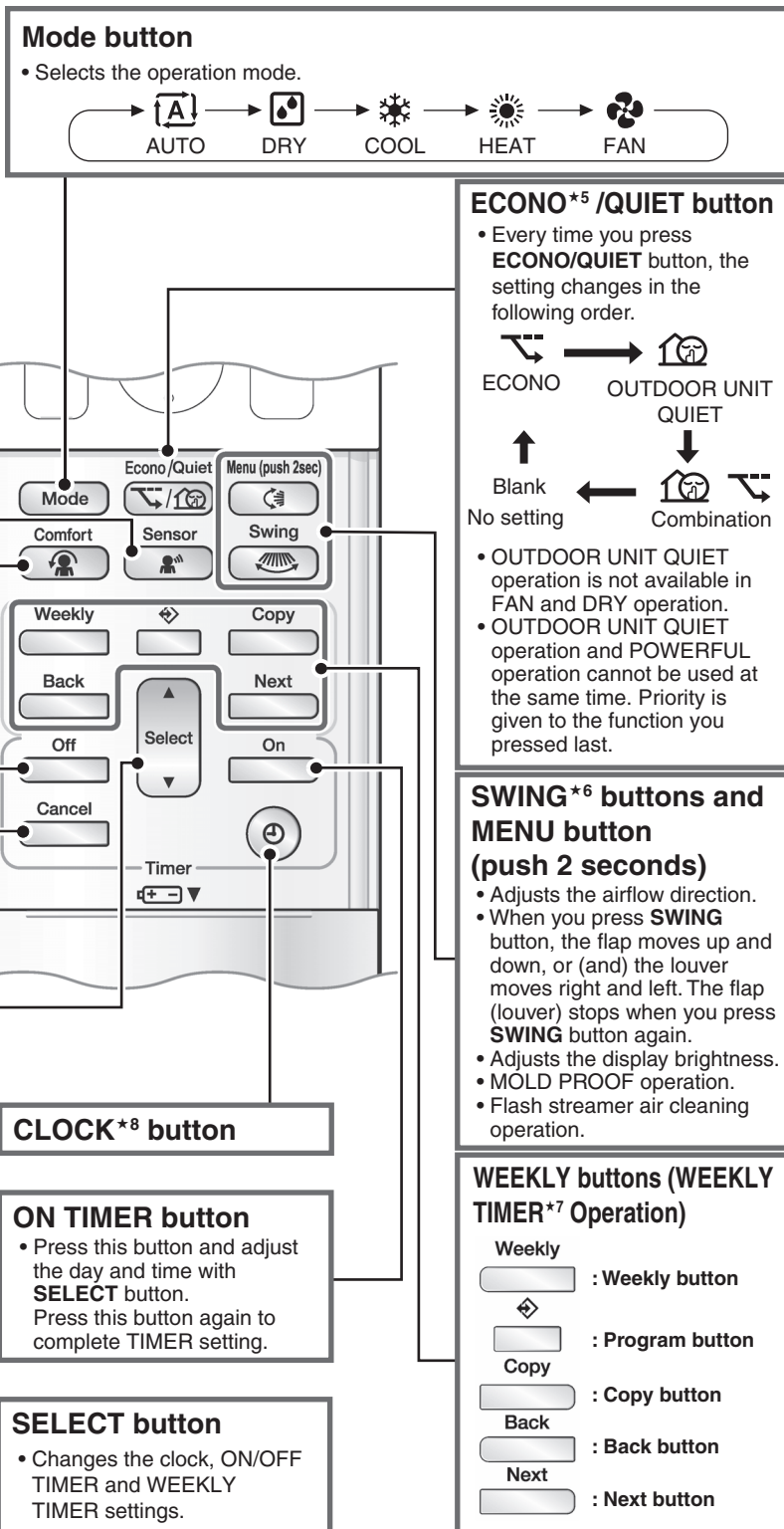
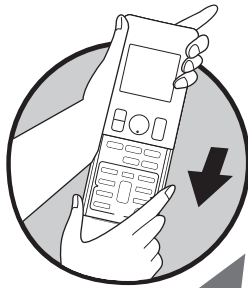

Reference Refer to the following pages for details.

- ★3 INTELLIGENT EYE operation P.40
- ★4 COMFORT AIRFLOW operation P.27
- ★5 ECONO operation P.35

- ★6 Auto-swing P.26
- ★7 WEEKLY TIMER operation P.44
- ★8 Clock setting P.43

Part 6

Service Diagnosis

1. General Problem Symptoms and Check Items	84
2. Troubleshooting with LED	85
2.1 Indoor Unit	85
2.2 Outdoor Unit	85
3. Service Diagnosis	86
3.1 Method 1	86
3.2 Method 2	87
4. Troubleshooting	89
4.1 Error Codes and Description	89
4.2 Indoor Unit PCB Abnormality	90
4.3 Freeze-up Protection Control/Heating Peak-cut Control	91
4.4 Indoor Fan Motor (DC Motor) or Related Abnormality	93
4.5 Thermistor or Related Abnormality	95
4.6 Humidity Sensor Abnormality	96
4.7 Refrigerant Shortage	97
4.8 Low-voltage Detection or Over-voltage Detection	99
4.9 Signal Transmission Error (Between Indoor Unit and Outdoor Unit)	101
4.10 Unspecified Voltage (Between Indoor Unit and Outdoor Unit)	103
4.11 Outdoor Unit PCB Abnormality	104
4.12 Actuation of High Pressure Switch	105
4.13 OL Activation (Compressor Overload)	106
4.14 Compressor Lock	109
4.15 DC Fan Lock	110
4.16 Input Overcurrent Detection	111
4.17 Four Way Valve Abnormality	113
4.18 Discharge Pipe Temperature Control	115
4.19 High Pressure Control in Cooling	117
4.20 System Shutdown due to Temperature Abnormality in Compressor	119
4.21 Compressor System Sensor Abnormality	120
4.22 Position Sensor Abnormality	121
4.23 DC Voltage/Current Sensor Abnormality	124
4.24 Thermistor or Related Abnormality (Outdoor Unit)	126
4.25 Electrical Box Temperature Rise	128
4.26 Radiation Fin Temperature Rise	129
4.27 Output Overcurrent Detection	131
5. Check	134
5.1 Thermistor Resistance Check	134
5.2 Indoor Fan Motor Connector Check	135
5.3 Power Supply Waveform Check	135

5.4	Electronic Expansion Valve Check.....	136
5.5	Four Way Valve Performance Check.....	137
5.6	Inverter Unit Refrigerant System Check.....	138
5.7	Inverter Analyzer Check.....	138
5.8	Rotation Pulse Check on the Outdoor Unit PCB.....	140
5.9	Installation Condition Check.....	141
5.10	Discharge Pressure Check.....	142
5.11	Outdoor Fan System Check.....	142
5.12	Main Circuit Short Check.....	142
5.13	Capacitor Voltage Check.....	144
5.14	Power Module Check.....	145

1. General Problem Symptoms and Check Items

Symptom	Check Item	Measures	Reference Page
The unit does not operate.	Check the power supply.	Check if the rated voltage is supplied.	—
	Check the type of the indoor unit.	Check if the indoor unit type is compatible with the outdoor unit.	—
	Check the outdoor temperature.	Heating/cooling operations are not available when the outdoor temperature is out of the operation limit. Check the reference page for the operation limit.	167
	Diagnose with remote controller indication.	—	89
	Check the remote controller addresses.	Check if address settings for the remote controller and indoor unit are correct.	152
Operation sometimes stops.	Check the power supply.	A power failure of 2 to 10 cycles stops air conditioner operation. (Operation lamp OFF)	—
	Check the outdoor temperature.	Heating/cooling operations are not available when the outdoor temperature is out of the operation limit. Check the reference page for the operation limit.	167
	Diagnose with remote controller indication.	—	89
The unit operates but does not cool, or does not heat.	Check for wiring and piping errors in the connection between the indoor unit and outdoor unit.	—	—
	Check for thermistor detection errors.	Check if the thermistor is mounted securely.	—
	Check for faulty operation of the electronic expansion valve.	Set the unit to cooling operation, and check the temperature of the liquid pipe to see if the electronic expansion valve works.	—
	Diagnose with remote controller indication.	—	89
	Diagnose by service port pressure and operating current.	Check for refrigerant shortage.	—
Large operating noise and vibrations	Check the output voltage of the power module.	—	145
	Check the power module.	—	—
	Check the installation condition.	Check if the required spaces for installation (specified in the installation manual) are provided.	—

2. Troubleshooting with LED

2.1 Indoor Unit

Operation Lamp

The operation lamp blinks when any of the following errors is detected.

1. A protection device of the indoor or outdoor unit is activated, or when the thermistor malfunctions.
2. A signal transmission error occurs between the indoor and outdoor units.

In either case, conduct the diagnostic procedure described in the following pages.

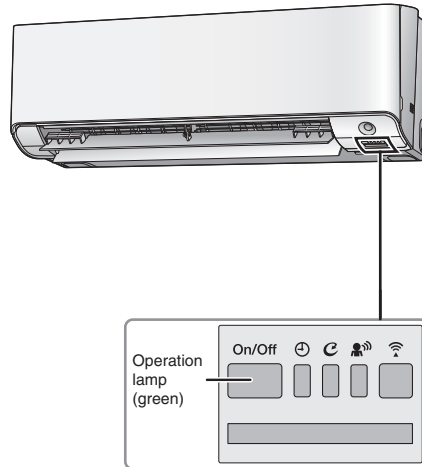

R4003807

2.2 Outdoor Unit

The outdoor unit has one green LED (LED A) on the PCB. When the microcomputer works in order, the LED A blinks.

Refer to pages 20, 21 for the location of LED.

3. Service Diagnosis

3.1 Method 1

1. When **Timer Cancel** button is held down for 5 seconds, **00** is displayed on the temperature display screen.
2. Press **Timer Cancel** button repeatedly until a long beep sounds.

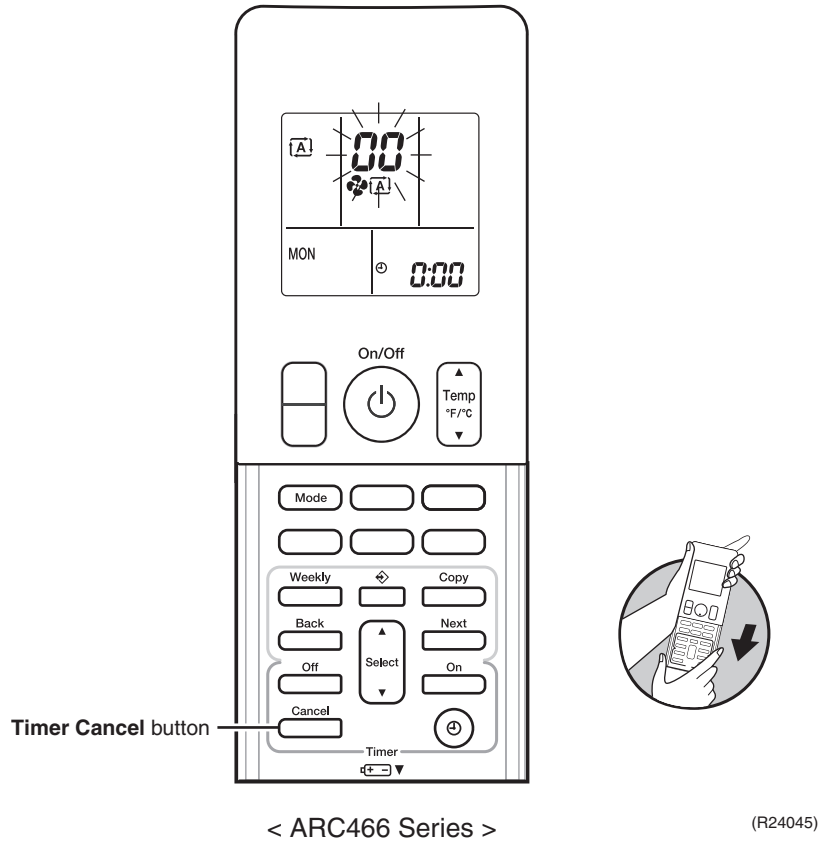

i Notes

1. A short beep or two consecutive beeps indicate non-corresponding codes.
2. To return to the normal mode, hold **Timer Cancel** button down for 5 seconds. When the remote controller is left untouched for 60 seconds, it also returns to the normal mode.
3. Not all the error codes are displayed. When you cannot find the error code, try method 2. Refer to page 87.

■ The code indication changes in the sequence shown below.

ARC466A70, A71

No.	Code	No.	Code	No.	Code	No.	Code	No.	Code
1	00	10	E6	19	E9	28	F1	37	E8
2	R5	11	H6	20	EE	29	E1	38	R4
3	E7	12	H0	21	E4	30	UR	39	FR
4	F3	13	R6	22	E5	31	U3	40	E8
5	F6	14	U0	23	EH	32	UF	41	E3
6	L3	15	E7	24	J3	33	UH	42	H3
7	L4	16	R3	25	J6	34	P4	43	F8
8	L5	17	H8	26	J8	35	H7	44	RD
9	U4	18	H9	27	E5	36	U2	—	—

3.2 Method 2

1. Press the center of **Temp** button and **Mode** button at the same time.

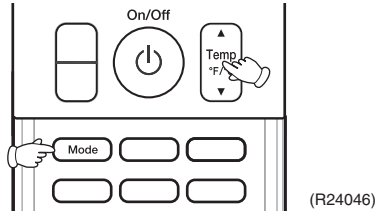

5C is displayed on the LCD.

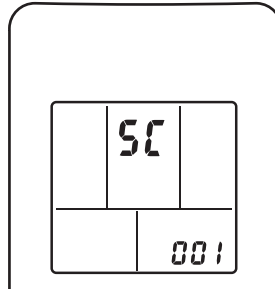

2. Select 5C (service check) with **Temp ▲** or **Temp ▼** button.
3. Press **Mode** button to enter the service check mode.

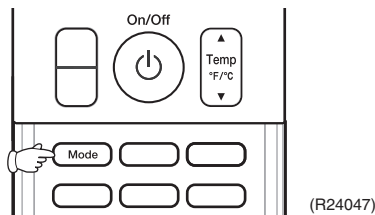

The left-side number blinks.

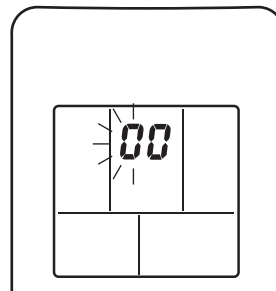

4. Press **Temp ▲** or **Temp ▼** button and change the number until you hear the two consecutive beeps or the long beep.

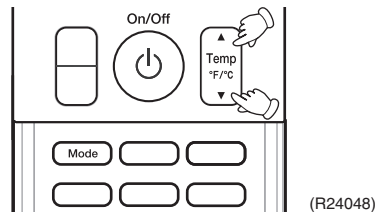

5. Diagnose by the sound.
 - Beep: The left-side number does not correspond with the error code.
 - Two consecutive beeps: The left-side number corresponds with the error code but the right-side number does not.

- Long beep: Both the left-side and right-side numbers correspond with the error code. The numbers indicated when you hear the long beep are the error code. Refer to page 89.

6. Press **Mode** button.

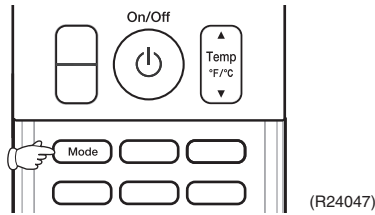

The right-side number blinks.

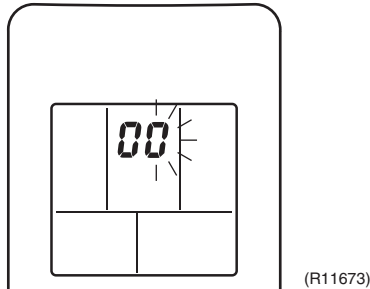

7. Press **Temp ▲** or **Temp ▼** button and change the number until you hear the long beep.

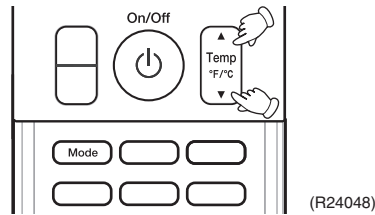

8. Diagnose by the sound.

- Beep: The left-side number does not correspond with the error code.
- Two consecutive beeps: The left-side number corresponds with the error code but the right-side number does not.
- Long beep: Both the left-side and right-side numbers correspond with the error code.

9. Determine the error code.

The numbers indicated when you hear the long beep are the error code. Refer to page 89.

10. Press **Mode** button for 5 seconds to exit from the service check mode.

When the remote controller is left untouched for 60 seconds, it returns to the normal mode also.

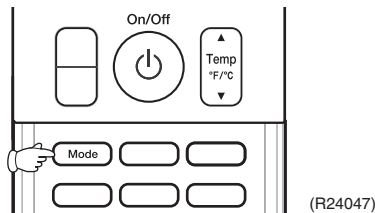

4. Troubleshooting

4.1 Error Codes and Description

	Error Codes	Description	Reference Page
System	00	Normal	—
	U0★	Refrigerant shortage	97
	U2	Low-voltage detection or over-voltage detection	99
	U4	Signal transmission error (between indoor unit and outdoor unit)	101
	UR	Unspecified voltage (between indoor unit and outdoor unit)	103
Indoor Unit	R1	Indoor unit PCB abnormality	90
	R5	Freeze-up protection control/heating peak-cut control	91
	R6	Fan motor (DC motor) or related abnormality	93
	E4	Indoor heat exchanger thermistor or related abnormality	95
	E9	Room temperature thermistor or related abnormality	95
	EC	Humidity sensor abnormality	96
Outdoor Unit	E1	Outdoor unit PCB abnormality	104
	E3	Actuation of high pressure switch	105
	E5★	OL activation (compressor overload)	106
	E6★	Compressor lock	109
	E7★	DC fan lock	110
	E8	Input overcurrent detection	111
	ER	Four way valve abnormality	113
	F3	Discharge pipe temperature control	115
	F6	High pressure control in cooling	117
	F8	System shutdown due to compressor internal temperature abnormality	119
	H0	Compressor system sensor abnormality	120
	H6	Position sensor abnormality	121
	H8	DC voltage/current sensor abnormality	124
	H9	Outdoor temperature thermistor or related abnormality	126
	J3★	Discharge pipe thermistor or related abnormality	126
	J6	Outdoor heat exchanger thermistor or related abnormality	126
	J8	Liquid pipe thermistor or related abnormality	126
	L3★	Electrical box temperature rise	128
	L4	Radiation fin temperature rise	129
	L5★	Output overcurrent detection	131
	P4	Radiation fin thermistor or related abnormality	126

★: Displayed only when system-down occurs.

4.2 Indoor Unit PCB Abnormality

Error Code	A1
Method of Error Detection	The system checks if the circuit works properly within the microcomputer of the indoor unit.
Error Decision Conditions	The system cannot set the internal settings.
Supposed Causes	<ul style="list-style-type: none"> ■ Defective indoor unit PCB ■ Disconnection of connector

Troubleshooting

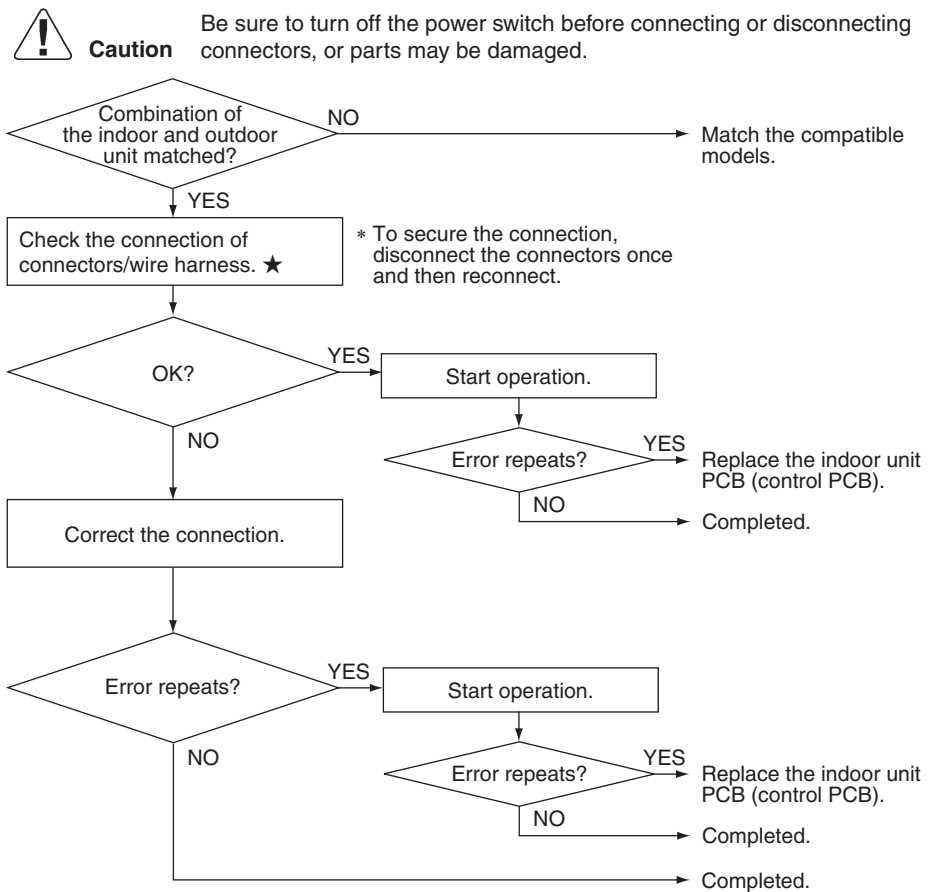

R6000804

i Note

★ Wire Harness (Connector)
Terminal strip ~ Power supply PCB (S101)
Power supply PCB (S102, S103) ~ Control PCB (S300A, S301B)

4.3 Freeze-up Protection Control/Heating Peak-cut Control

Error Code	A5
Method of Error Detection	<ul style="list-style-type: none"> ■ Freeze-up protection control During cooling operation, the freeze-up protection control (operation halt) is activated according to the temperature detected by the indoor heat exchanger thermistor. ■ Heating peak-cut control During heating operation, the temperature detected by the indoor heat exchanger thermistor is used for the heating peak-cut control (operation halt, outdoor fan stop, etc.)
Error Decision Conditions	<ul style="list-style-type: none"> ■ Freeze-up protection control During cooling operation, the indoor heat exchanger temperature is below 0°C (32°F). ■ Heating peak-cut control During heating operation, the indoor heat exchanger temperature is above 60 ~ 62°C (140 ~ 144°F).
Supposed Causes	<ul style="list-style-type: none"> ■ Short-circuited air ■ Clogged air filter of the indoor unit ■ Dust accumulation on the indoor heat exchanger ■ Defective indoor heat exchanger thermistor ■ Defective indoor unit PCB

Troubleshooting

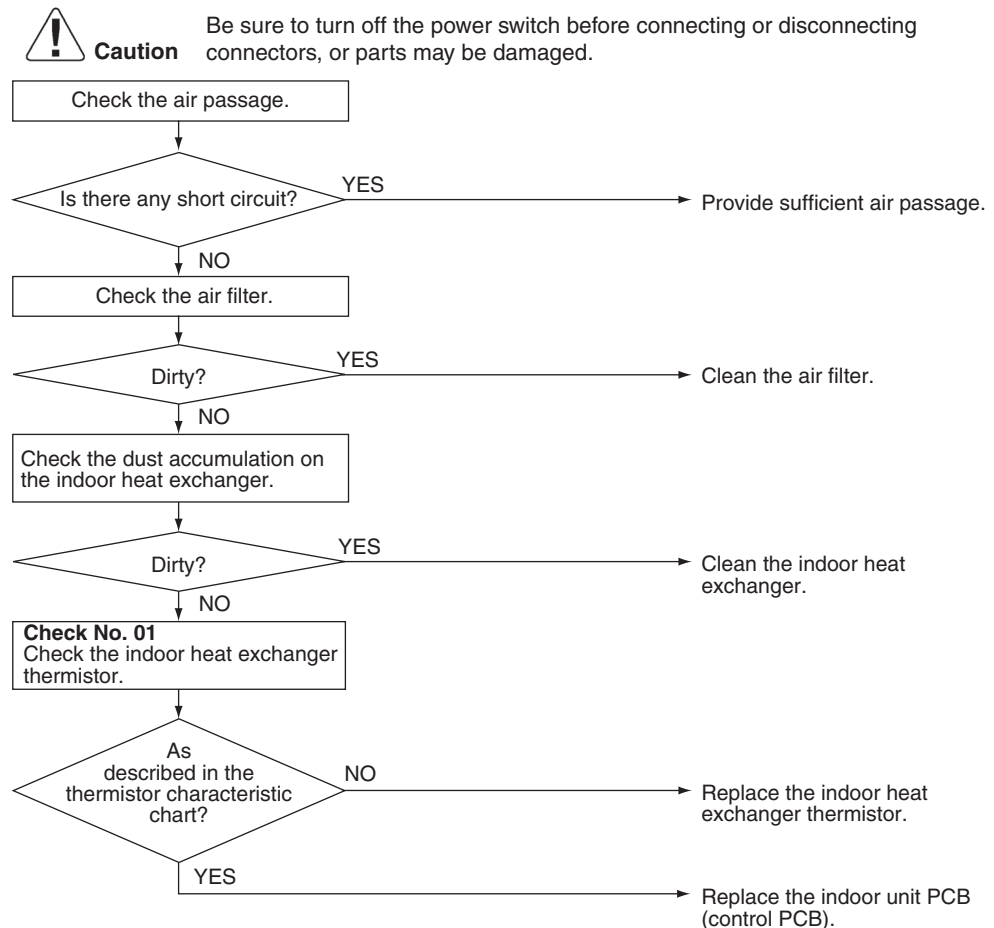

(R21064)



Reference **Check No.01** Refer to P.134

4.4 Indoor Fan Motor (DC Motor) or Related Abnormality

Error Code	FE
Method of Error Detection	The rotation speed detected by the microcomputer software during indoor fan motor operation determines abnormal fan motor operation.
Error Decision Conditions	<ul style="list-style-type: none">■ The detected rotation speed does not reach the demanded rotation speed of the target tap, and is less than 50% of the maximum fan motor rotation speed.■ The fan motor does not rotate for continuously more than 5 seconds after it starts.
Supposed Causes	<ul style="list-style-type: none">■ Remarkable decrease in power supply voltage■ Layer short inside the fan motor winding■ Breaking of wire inside the fan motor■ Breaking of the fan motor lead wires■ Defective capacitor of the fan motor■ Defective indoor unit PCB

Troubleshooting

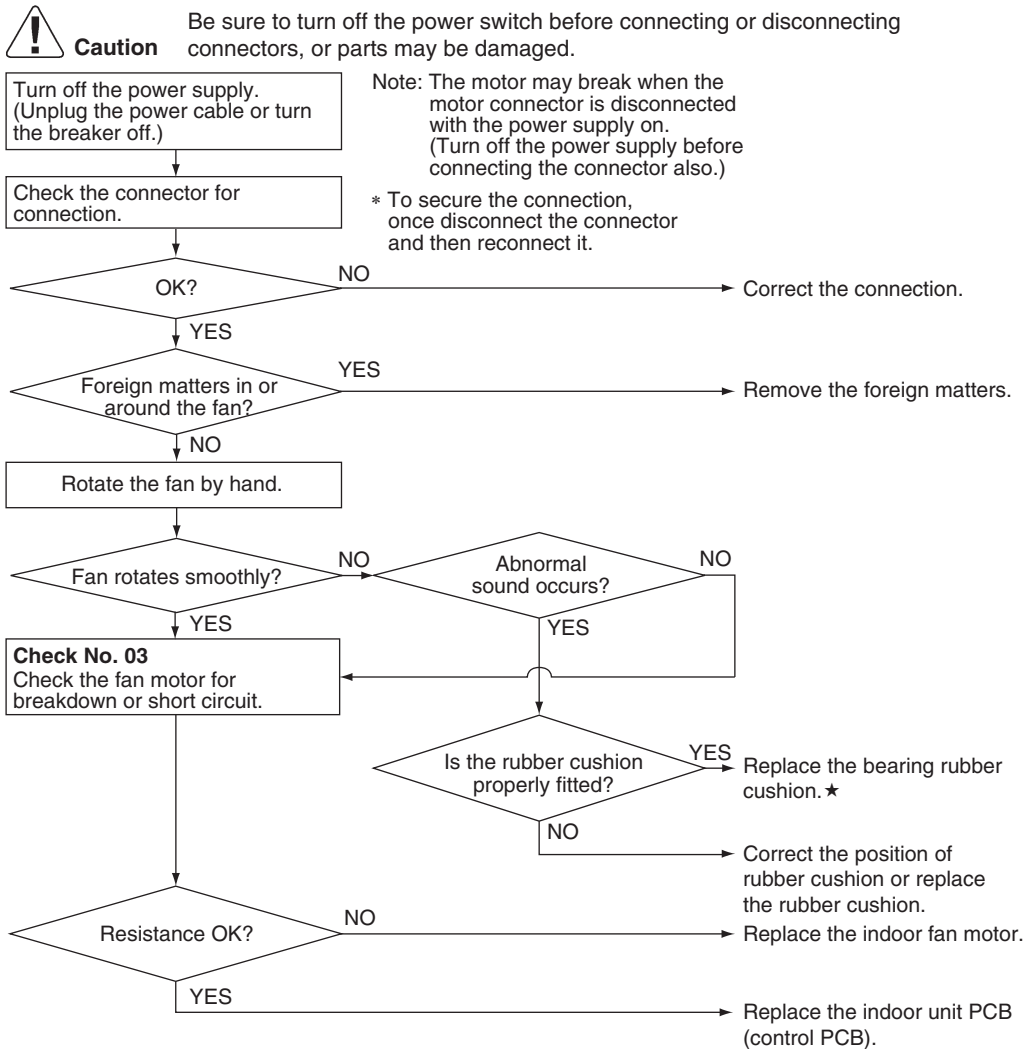

R6000805

★Rubber cushion

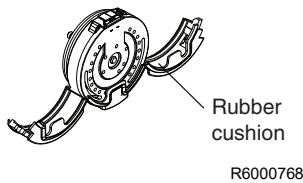

Reference

Check No.03 Refer to P.135

4.5 Thermistor or Related Abnormality

Error Code	ℰ4, ℰ9
Method of Error Detection	The temperatures detected by the thermistors determine thermistor errors.
Error Decision Conditions	The communication error of thermistor(s) or malfunction of thermistor(s).
Supposed Causes	<ul style="list-style-type: none"> ■ Disconnection of connector ■ Defective thermistor(s) ■ Defective indoor unit PCB

Troubleshooting

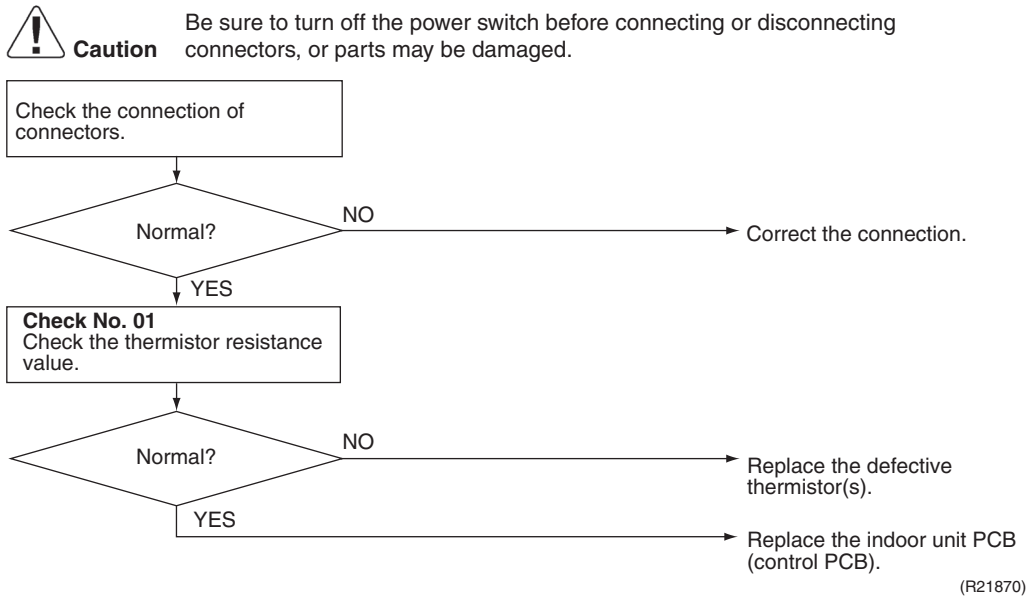

ℰ4 : Indoor heat exchanger thermistor
 ℰ9 : Room temperature thermistor



Reference

Check No.01 Refer to P.134

4.6 Humidity Sensor Abnormality

Error Code	CC
Method of Error Detection	Sensor abnormality is detected by input value.
Error Decision Conditions	The communication error of humidity sensor or malfunction of humidity sensor.
Supposed Causes	<ul style="list-style-type: none"> ■ Disconnection of connector ■ Defective humidity sensor ■ Defective indoor unit PCB

Troubleshooting

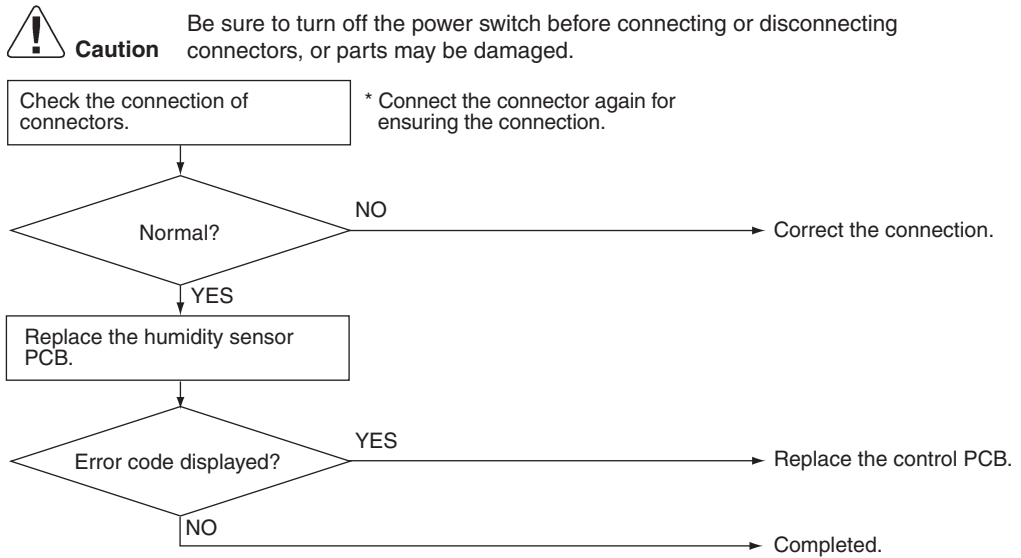

R6000515

4.7 Refrigerant Shortage

Error Code



Method of Error Detection

Refrigerant shortage detection I:

Refrigerant shortage is detected by checking the input current value and the compressor running frequency. If there is insufficient refrigerant, the input current tends to be lower than the normal value.

Refrigerant shortage detection II:

Refrigerant shortage is detected by checking the discharge pipe temperature and the opening of the electronic expansion valve. If there is insufficient refrigerant, the discharge pipe temperature tends to rise.

Refrigerant shortage detection III:

Refrigerant shortage is detected by checking the difference between suction and discharge temperature.

Error Decision Conditions

Refrigerant shortage detection I:

The following conditions continue for 7 minutes.

- Input current × input voltage ≤ **A** × output frequency + **B**
- Output frequency > **C**

	A (-)	B (W)	C (Hz)
09/12 class	2800/256	-350	55
18/24 class	4000/256	-200	38

Refrigerant shortage detection II:

The following conditions continue for 80 seconds.

- Opening of the electronic expansion valve ≥ **D**
- Discharge pipe temperature > **E** × target discharge pipe temperature + **F**(°C)
(Discharge pipe temperature > **E** × target discharge pipe temperature + **G**(°F))

	D (pulse)	E (-)	F (°C)	G (°F)
09/12 class	470	128/128	cooling: 20, heating: 20	cooling: 68, heating: 68
18/24 class	490	128/128	cooling: 30, heating: 50	cooling: 86, heating: 122

Refrigerant shortage detection III:

Refrigerant shortage is detected when the difference of the temperature is smaller than **H**(°C (°F))

			H	
			09/12 class	18/24 class
Cooling	Room thermistor temperature - indoor heat exchanger thermistor	(°C)	4.0	3.5
		(°F)	7	6
	Outdoor heat exchanger temperature - outdoor temperature	(°C)	4.0	3.5
		(°F)	7	6
Heating	Indoor heat exchanger temperature - room thermistor temperature	(°C)	4.0	3.5
		(°F)	7	6
	Outdoor temperature - outdoor heat exchanger temperature	(°C)	4.0	3.5
		(°F)	7	6

- If the error repeats, the system is shut down.
- Reset condition: Continuous run for about 60 minutes without any other error

Troubleshooting



Caution

Be sure to turn off the power switch before connecting or disconnecting connectors, or parts may be damaged.

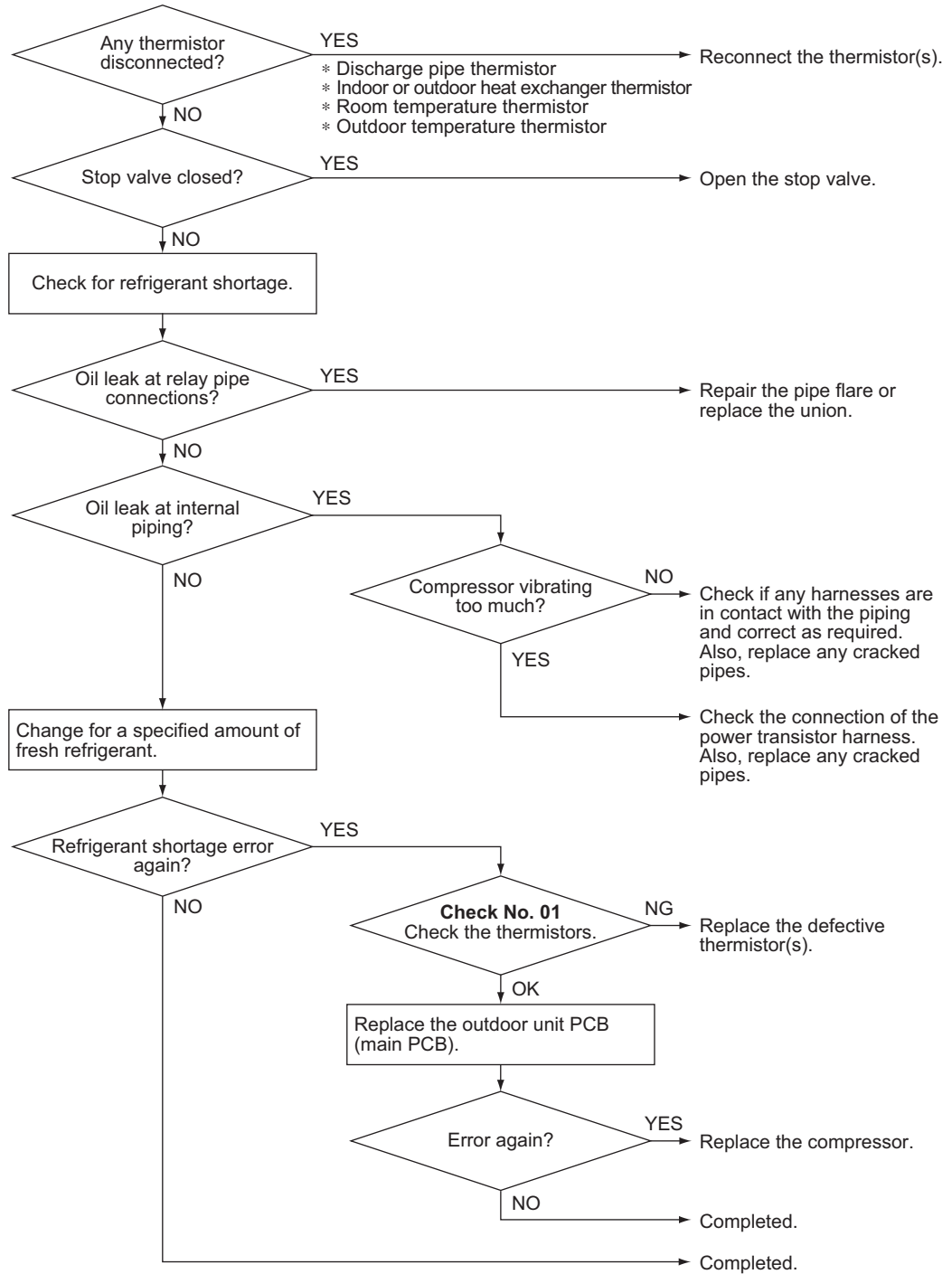

(R24716)



Reference

Check No.01 Refer to P.134

4.8 Low-voltage Detection or Over-voltage Detection

Error Code	U2
Method of Error Detection	<ul style="list-style-type: none"> ■ Indoor Unit Low-voltage detection: An abnormal voltage drop is detected by the DC voltage detection circuit. ■ Outdoor Unit Low-voltage detection: An abnormal voltage drop is detected by the DC voltage detection circuit. Over-voltage detection: An abnormal voltage rise is detected by the over-voltage detection circuit.
Error Decision Conditions	<ul style="list-style-type: none"> ■ Indoor Unit The voltage detected by the DC voltage detection circuit is below 140 V. ■ Outdoor Unit Low-voltage detection: <ul style="list-style-type: none"> ● The voltage detected by the DC voltage detection circuit is below 162 V (09/12 class), 160 V (18/24 class). ● The compressor stops if the error occurs, and restarts automatically after 3-minute standby. Over-voltage detection: <ul style="list-style-type: none"> ● The voltage detected by the DC voltage detection circuit is below 458 V (depending on the model). ● An over-voltage signal is fed from the over-voltage detection circuit to the microcomputer. ● The compressor stops if the error occurs, and restarts automatically after 3-minute standby.
Supposed Causes	<ul style="list-style-type: none"> ■ Power supply voltage out of specification ■ Defective DC voltage detection circuit ■ Defective over-voltage detection circuit ■ Defective PAM control part ■ Disconnection of compressor harness ■ Short circuit inside the fan motor winding ■ Noise ■ Momentary drop of voltage ■ Momentary power failure ■ Defective outdoor unit PCB ■ Defective indoor unit PCB

Troubleshooting

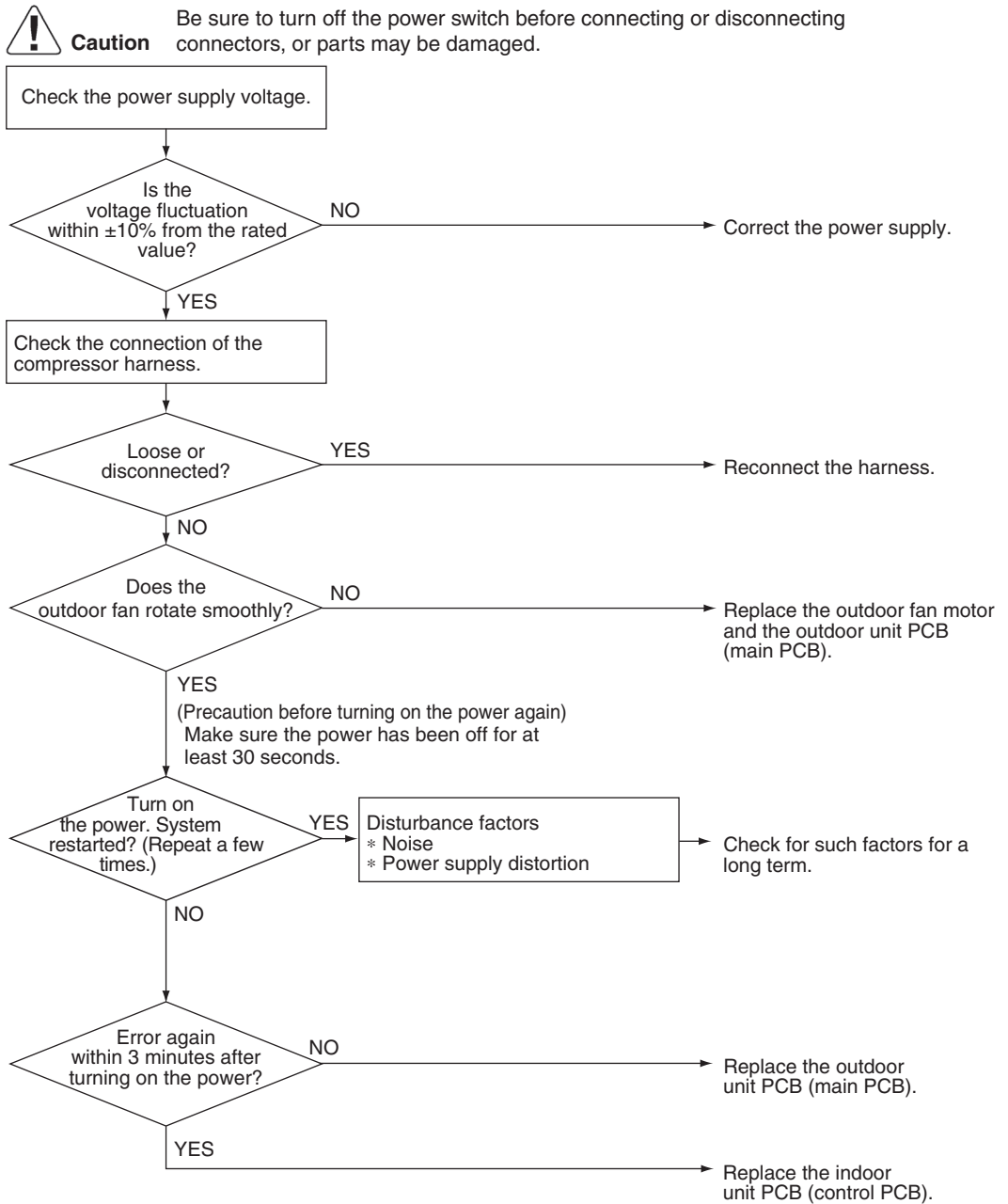

(R22370)

4.9 Signal Transmission Error (Between Indoor Unit and Outdoor Unit)

Error Code	U4
Method of Error Detection	The signal transmission data received from the outdoor unit is checked whether it is normal.
Error Decision Conditions	The data sent from the outdoor unit cannot be received normally, or the content of the data is abnormal.
Supposed Causes	<ul style="list-style-type: none">■ Power supply voltage out of specification■ Reduction of power supply voltage■ Wiring error■ Breaking of the connection wires between the indoor and outdoor units (wire No. 3)■ Defective outdoor unit PCB■ Short circuit inside the fan motor winding■ Defective indoor unit PCB■ Disturbed power supply waveform

Troubleshooting

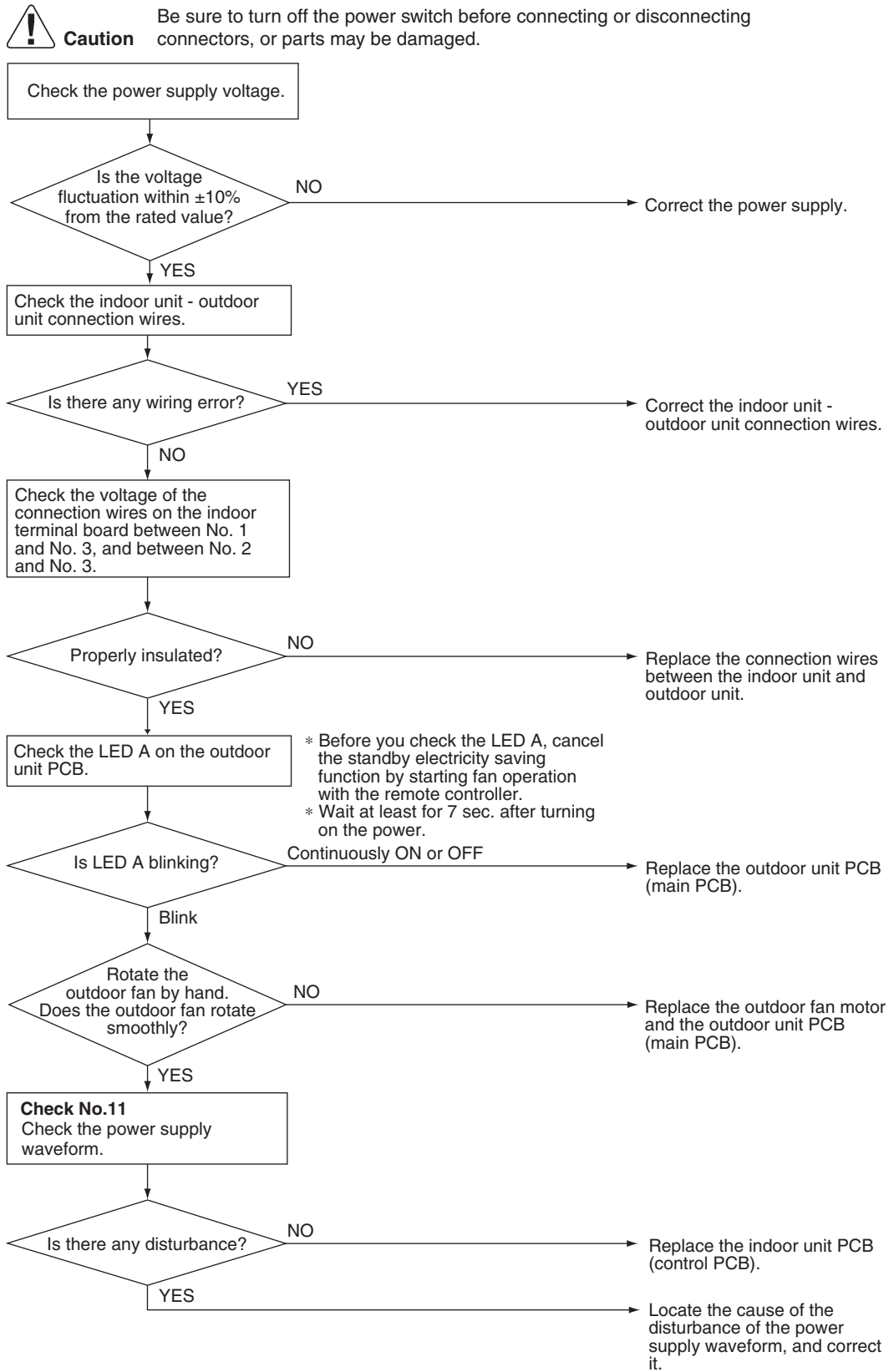

(R21199)



Reference

Check No.11 Refer to P.135

4.10 Unspecified Voltage (Between Indoor Unit and Outdoor Unit)

Error Code

UR

Method of Error Detection

The supply power is detected for its requirements (pair type is different from multi type) by the indoor/outdoor transmission signal.

Error Decision Conditions

The pair type and multi type are interconnected.

Supposed Causes

- Wrong models interconnected
- Wrong wiring of connecting wires
- Wrong indoor unit PCB or outdoor unit PCB mounted
- Defective indoor unit PCB
- Defective outdoor unit PCB

Troubleshooting



Caution

Be sure to turn off the power switch before connecting or disconnecting connectors, or parts may be damaged.

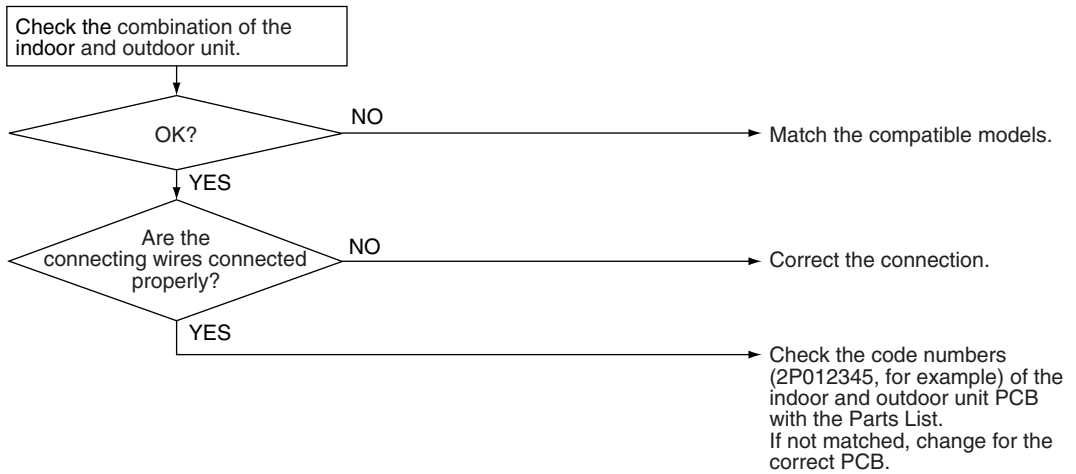

(R20435)

4.11 Outdoor Unit PCB Abnormality

Error Code	E1
Method of Error Detection	<ul style="list-style-type: none"> ■ The system checks if the microprocessor is working in order. ■ The system checks if the zero-cross signal comes in properly.
Error Decision Conditions	<ul style="list-style-type: none"> ■ The microprocessor program runs out of control. ■ The zero-cross signal is not detected.
Supposed Causes	<ul style="list-style-type: none"> ■ Defective outdoor unit PCB ■ Noise ■ Momentary drop of voltage ■ Momentary power failure

Troubleshooting

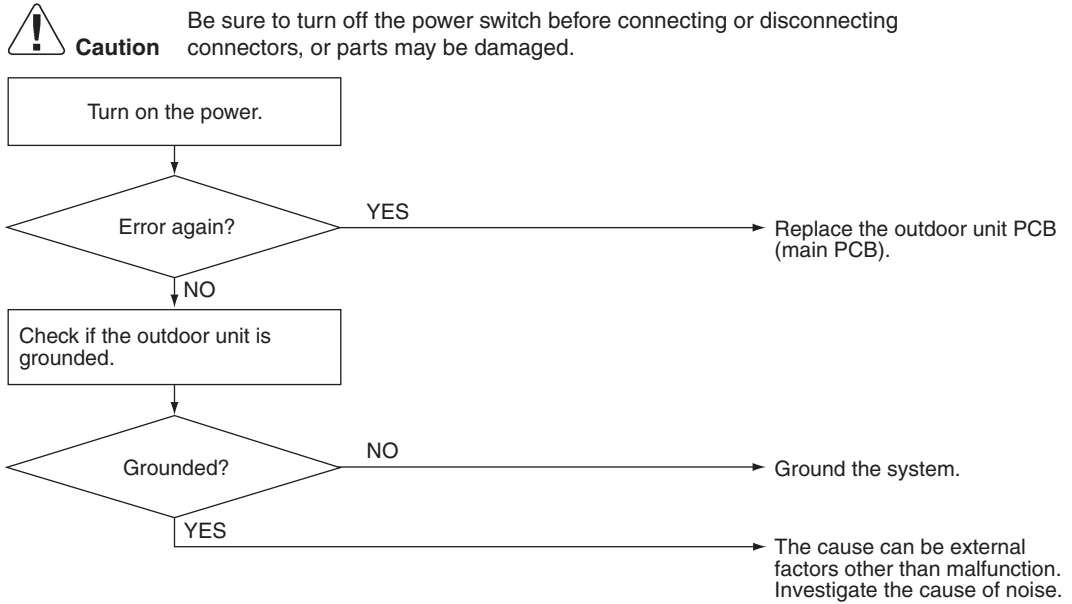

(R21809)

4.12 Actuation of High Pressure Switch

Error Code



Method of Error Detection

Abnormality is detected when the contact of the high pressure switch opens.

Error Decision Conditions

- High pressure switch (S1PH) activating pressure: 4.15 MPa
- High pressure switch (S1PH) recovery pressure: 3.2 MPa

Supposed Causes

- Actuation of high pressure switch (S1PH)
- Closed stop valve
- Disconnection of connector S40
- Disconnection of 2 terminals of high pressure switch (S1PH)
- Defective outdoor unit PCB
- Broken S1PH harness
- Defective high pressure switch (S1PH)

Troubleshooting



Caution

Be sure to turn off the power switch before connecting or disconnecting connectors, or parts may be damaged.

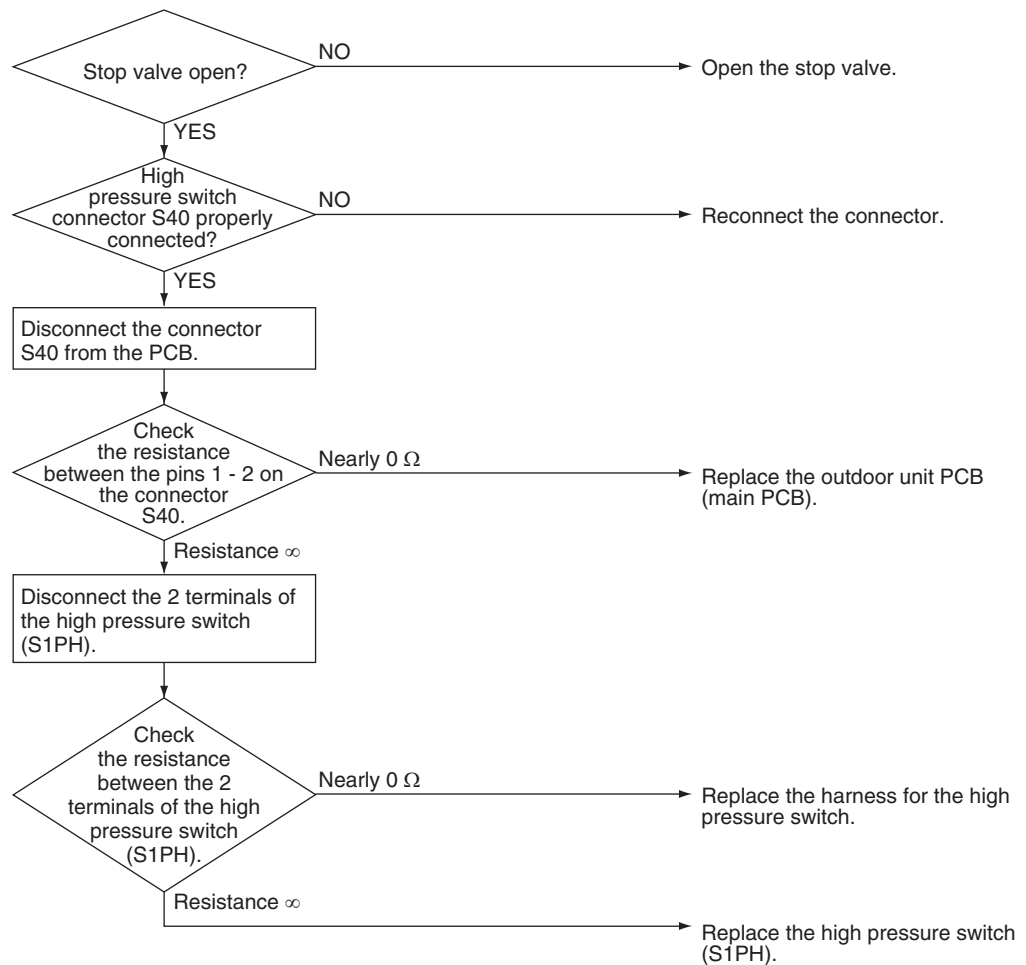

(R22435)

4.13 OL Activation (Compressor Overload)

Error Code	E5
Method of Error Detection	A compressor overload is detected through compressor OL.
Error Decision Conditions	<ul style="list-style-type: none">■ If the error repeats, the system is shut down.■ Reset condition: Continuous run for about 60 minutes without any other error
Supposed Causes	<ul style="list-style-type: none">■ Disconnection of discharge pipe thermistor■ Defective discharge pipe thermistor■ Disconnection of connector S40■ Disconnection of 2 terminals of OL (Q1M)■ Defective OL (Q1M)■ Broken OL harness■ Defective electronic expansion valve or coil■ Defective four way valve or coil■ Defective outdoor unit PCB■ Refrigerant shortage■ Water mixed in refrigerant■ Defective stop valve

Troubleshooting



Caution Be sure to turn off the power switch before connecting or disconnecting connectors, or parts may be damaged.

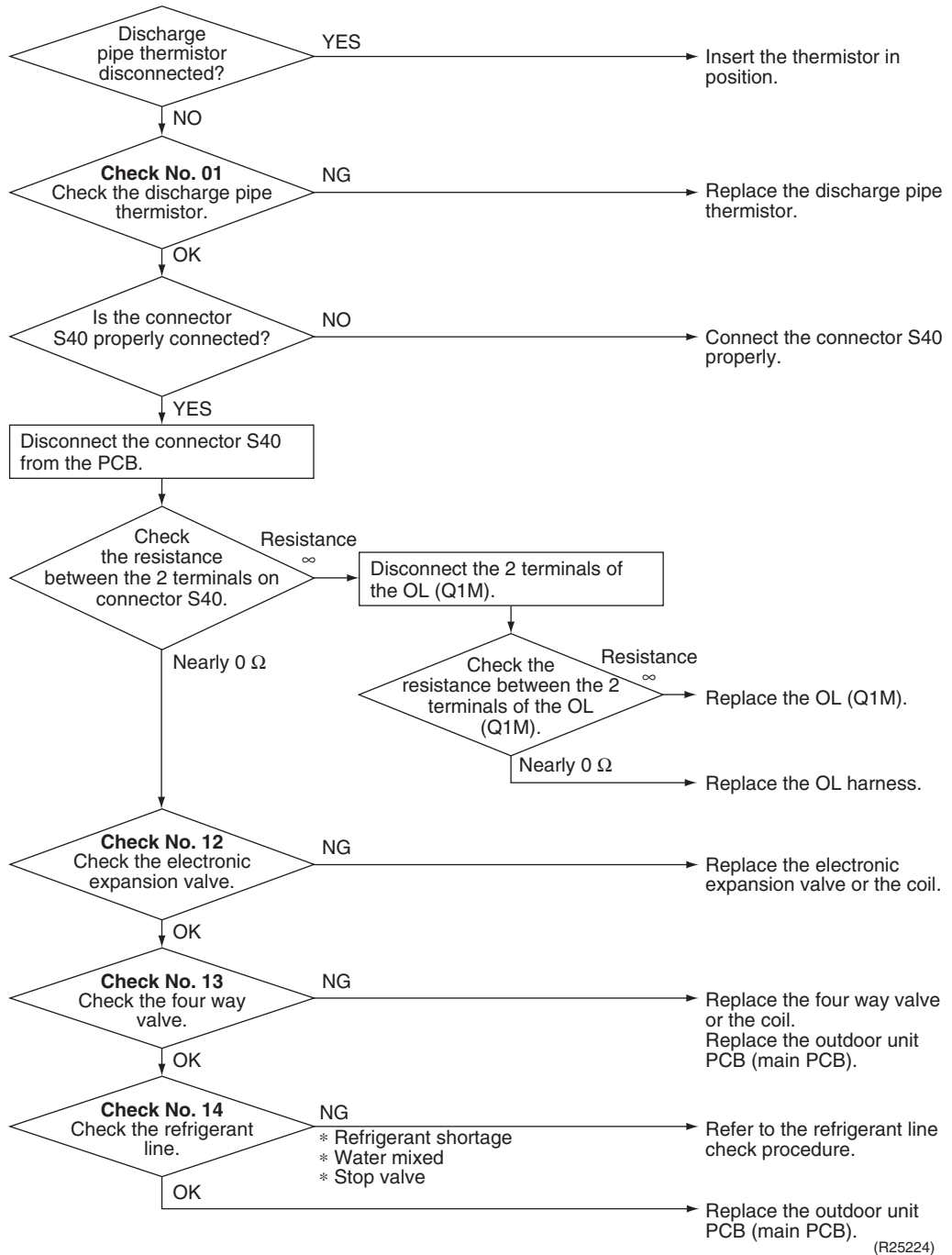

Note

OL (Q1M) activating temperature: 120 ~ 130°C (248 ~ 266°F)
 OL (Q1M) recovery temperature: 105°C (221°F)



Reference

Check No.01 Refer to P.134



Reference

Check No.12 Refer to P.136



Reference **Check No.13** Refer to P.137



Reference **Check No.14** Refer to P.138

4.14 Compressor Lock

Error Code	E6
Method of Error Detection	A compressor lock is detected by the current waveform generated when applying high-frequency voltage to the motor.
Error Decision Conditions	<ul style="list-style-type: none"> ■ If the error repeats, the system is shut down. ■ Reset condition: Continuous run for about 11 minutes without any other error
Supposed Causes	<ul style="list-style-type: none"> ■ Closed stop valve ■ Compressor locked ■ Disconnection of compressor harness

Troubleshooting

 **Caution** Be sure to turn off the power switch before connecting or disconnecting connectors, or parts may be damaged.
 (Precaution before turning on the power again)
 Make sure the power has been off for at least 30 seconds.

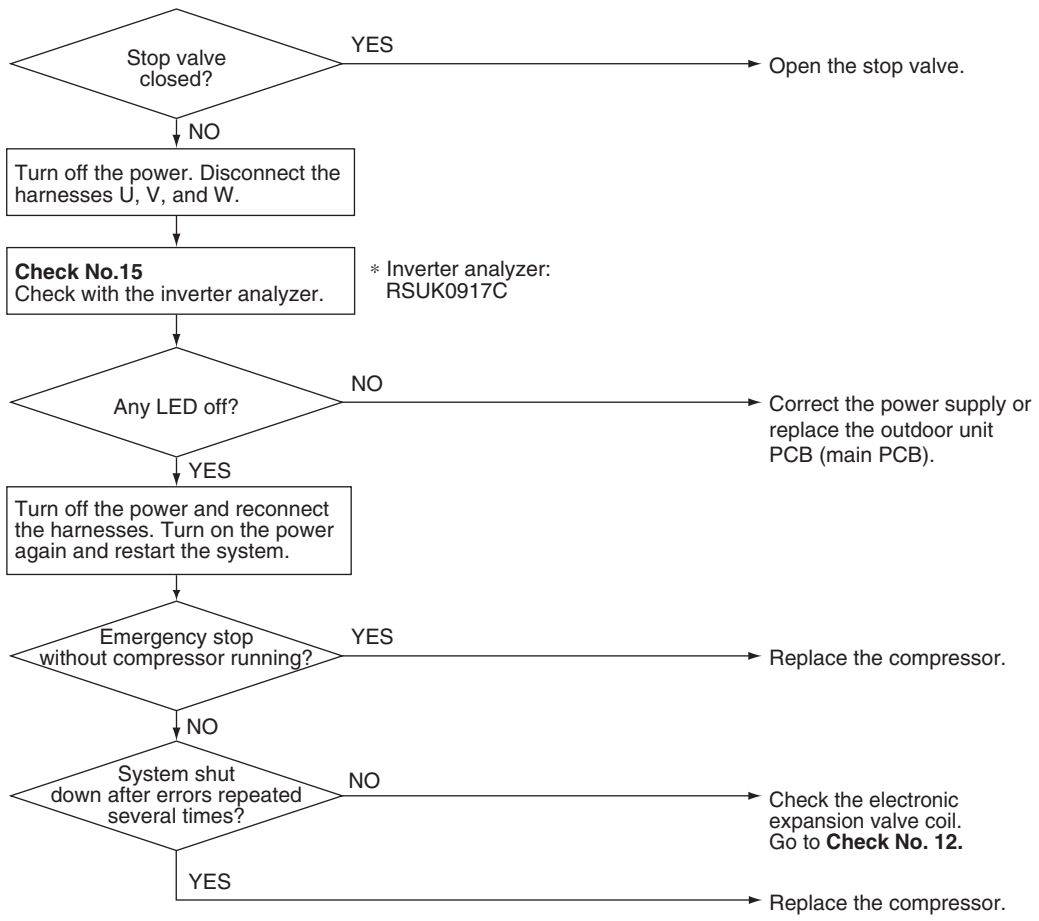

(R21067)

 **Reference** **Check No.12** Refer to P.136

 **Reference** **Check No.15** Refer to P.138

4.15 DC Fan Lock

Error Code	E7
Method of Error Detection	An error is determined with the high-voltage fan motor rotation speed detected by the Hall IC.
Error Decision Conditions	<ul style="list-style-type: none"> ■ The fan does not start in 15 ~ 30 seconds even when the fan motor is running. ■ If the error repeats, the system is shut down. ■ Reset condition: Continuous run for about 11 minutes without any other error
Supposed Causes	<ul style="list-style-type: none"> ■ Disconnection of the fan motor ■ Foreign matter stuck in the fan ■ Defective fan motor ■ Defective outdoor unit PCB

Troubleshooting

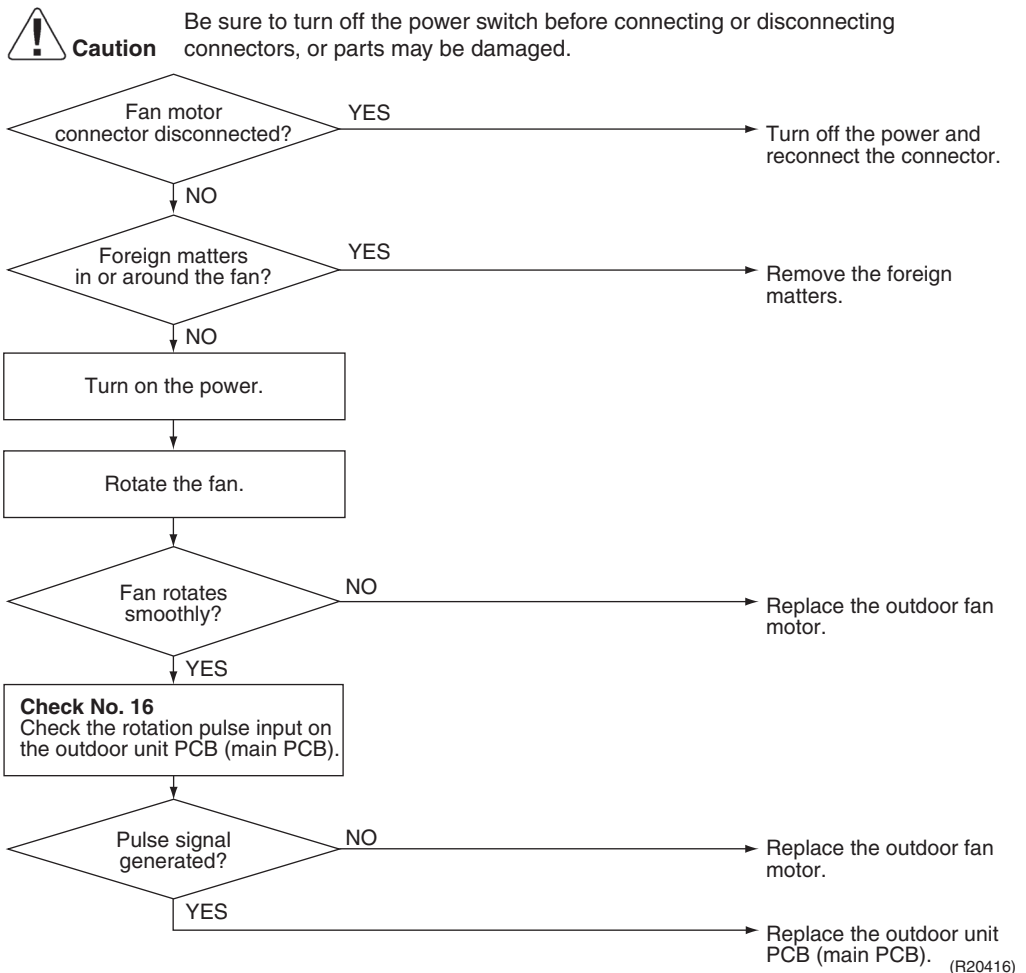

Reference Check No.16 Refer to P.140

4.16 Input Overcurrent Detection

Error Code	E8
Method of Error Detection	An input overcurrent is detected by checking the input current value with the compressor running.
Error Decision Conditions	The current exceeds about 13 ~ 20 A (depending on the model) for 2.5 seconds with the compressor running. The upper limit of the current decreases when the outdoor temperature exceeds a certain level.
Supposed Causes	<ul style="list-style-type: none">■ Outdoor temperature is out of operation range.■ Defective compressor■ Defective power module■ Defective outdoor unit PCB■ Short circuit



Troubleshooting

 **Caution** Be sure to turn off the power switch before connecting or disconnecting connectors, or parts may be damaged.

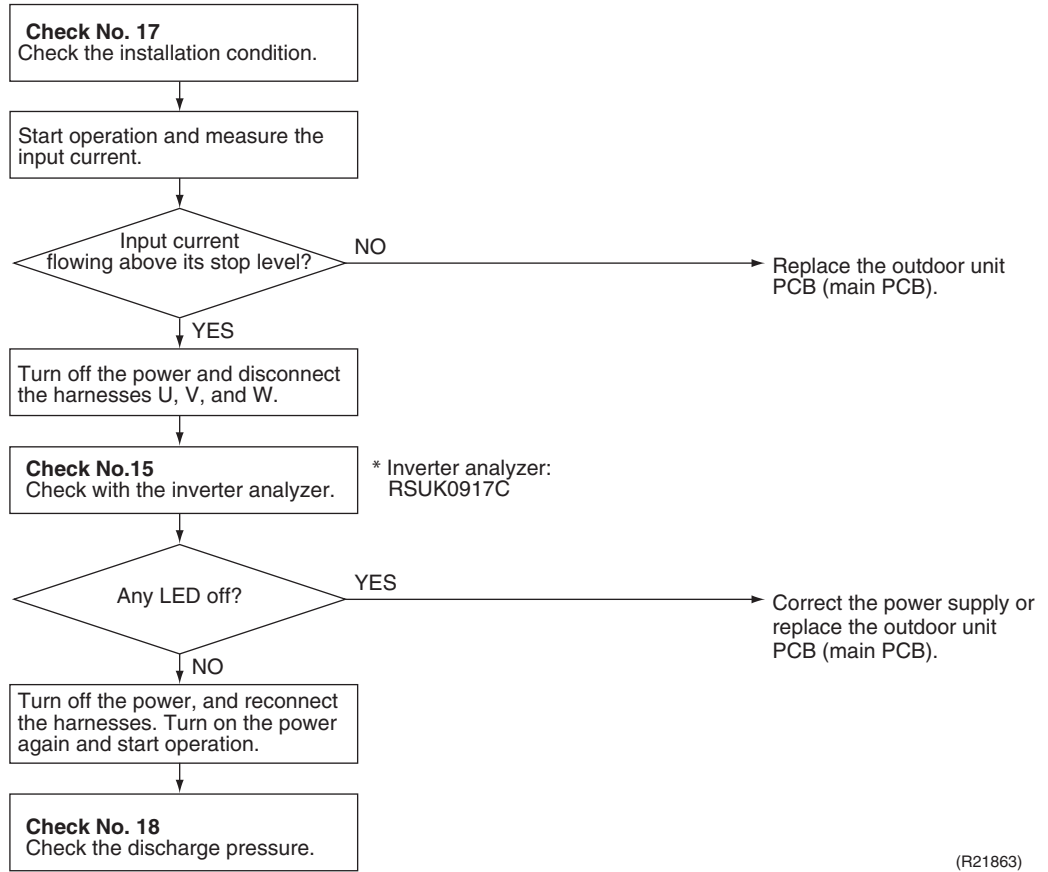
* An input overcurrent may result from wrong internal wiring. If the system is interrupted by an input overcurrent after the wires have been disconnected and reconnected for part replacement, check the wiring again.



(R21863)

-  **Reference** **Check No.15** Refer to P.138
-  **Reference** **Check No.17** Refer to P.141
-  **Reference** **Check No.18** Refer to P.142

4.17 Four Way Valve Abnormality

Error Code	E8
Method of Error Detection	The room temperature thermistor and the indoor heat exchanger thermistor are checked if they function within their normal ranges in each operation mode.
Error Decision Conditions	<p>The following condition continues over 1 ~ 10 minutes (depending on the model) after operating for 5 ~ 10 minutes (depending on the model).</p> <ul style="list-style-type: none"> ■ Cooling/Dry $A - B < -5^{\circ}\text{C}$ ($A - B < -9^{\circ}\text{F}$) ■ Heating $B - A < -5^{\circ}\text{C}$ ($B - A < -9^{\circ}\text{F}$) <p>A: Room thermistor temperature B: Indoor heat exchanger temperature</p> <ul style="list-style-type: none"> ■ If the error repeats, the system is shut down. ■ Reset condition: Continuous run for about 60 minutes without any other error
Supposed Causes	<ul style="list-style-type: none"> ■ Disconnection of four way valve coil ■ Defective four way valve, coil, or harness ■ Defective outdoor unit PCB ■ Defective thermistor ■ Refrigerant shortage ■ Water mixed in refrigerant ■ Defective stop valve

Troubleshooting

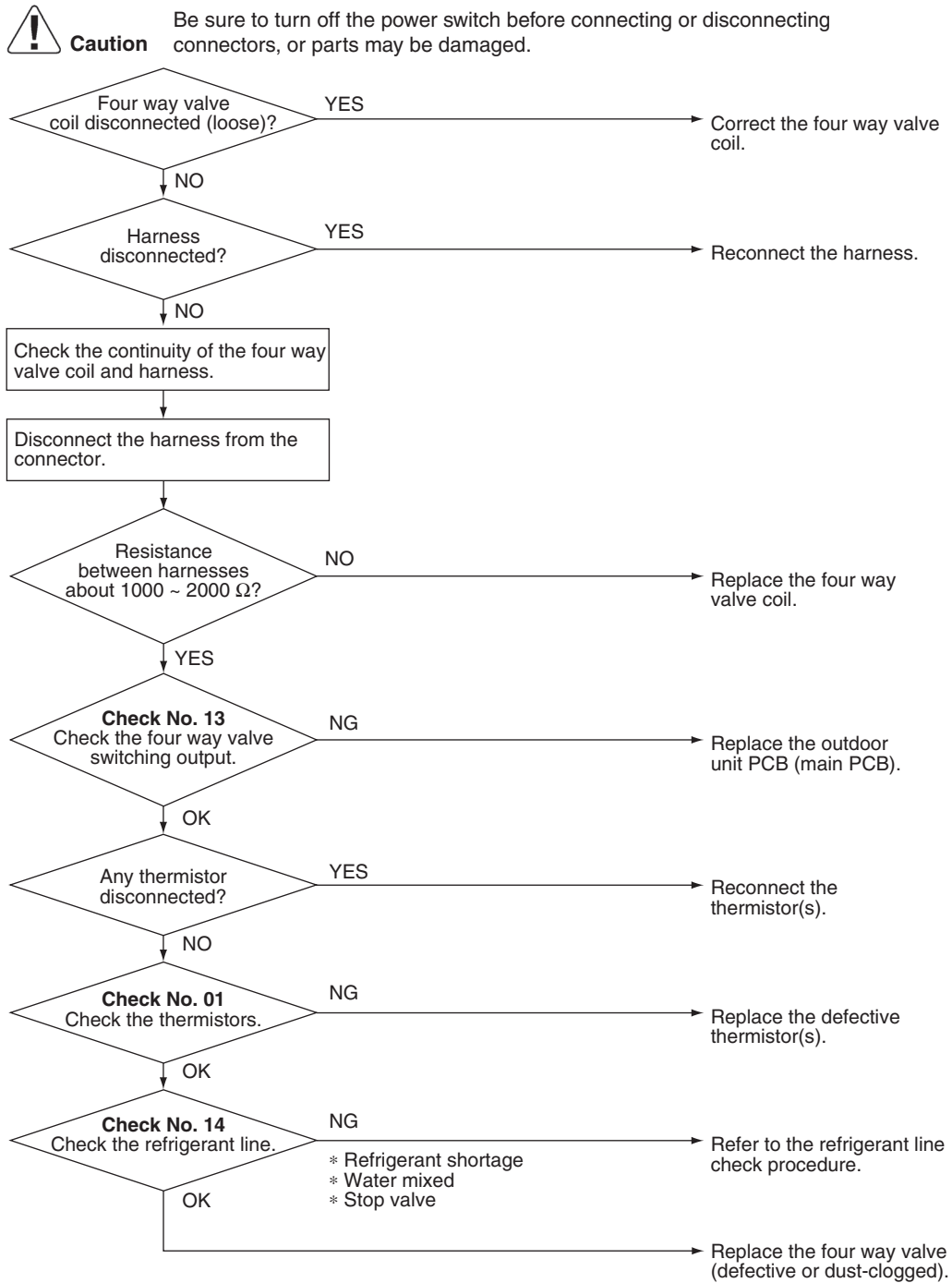

(R20405)



Reference Check No.01 Refer to P.134



Reference Check No.13 Refer to P.137



Reference Check No.14 Refer to P.138

4.18 Discharge Pipe Temperature Control

Error Code



Method of Error Detection

An error is determined with the temperature detected by the discharge pipe thermistor.

Error Decision Conditions

- If the temperature detected by the discharge pipe thermistor rises above **A**, the compressor stops.
- The error is cleared when the discharge pipe temperature has dropped below **B**.
- If the error repeats, the system is shut down.
- Reset condition: Continuous run for about 60 minutes without any other error

09/12 class

	A		B	
	(°C)	(°F)	(°C)	(°F)
(1) above 50 Hz (rising), above 45 Hz (dropping)	118	244	85	185
(2) 21 ~ 50 Hz (rising), 16 ~ 45 Hz (dropping)	106	223	73	163
(3) below 21 Hz (rising), below 16 Hz (dropping)	98	208	65	149

18/24 class

A		B	
(°C)	(°F)	(°C)	(°F)
118	244	85	185

Supposed Causes

- Defective discharge pipe thermistor
(Defective outdoor heat exchanger thermistor or outdoor temperature thermistor)
- Defective electronic expansion valve or coil
- Refrigerant shortage
- Defective four way valve
- Water mixed in refrigerant
- Defective stop valve
- Defective outdoor unit PCB

Troubleshooting



Caution Be sure to turn off the power switch before connecting or disconnecting connectors, or parts may be damaged.

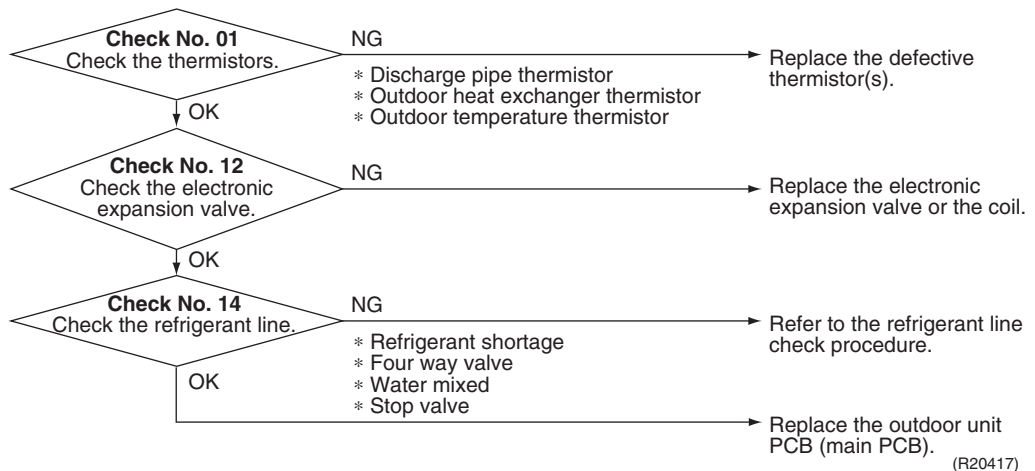



Reference **Check No.01** Refer to P.134



Reference **Check No.12** Refer to P.136



Reference **Check No.14** Refer to P.138

4.19 High Pressure Control in Cooling

Error Code	P6			
Method of Error Detection	High-pressure control (operation halt, frequency drop, etc.) is activated in cooling operation if the temperature sensed by the outdoor heat exchanger thermistor exceeds the limit.			
Error Decision Conditions	<ul style="list-style-type: none"> ■ The temperature sensed by the outdoor heat exchanger thermistor rises above A. ■ The error is cleared when the temperature drops below B. 			
	A		B	
	(°C)	(°F)	(°C)	(°F)
09/12 class	62	144	54	129
18/24 class	61	142	52	126
Supposed Causes	<ul style="list-style-type: none"> ■ Installation space not large enough ■ Dirty outdoor heat exchanger ■ Defective outdoor fan motor ■ Defective stop valve ■ Defective electronic expansion valve or coil ■ Defective outdoor heat exchanger thermistor ■ Defective outdoor unit PCB 			

Troubleshooting



Caution Be sure to turn off the power switch before connecting or disconnecting connectors, or parts may be damaged.

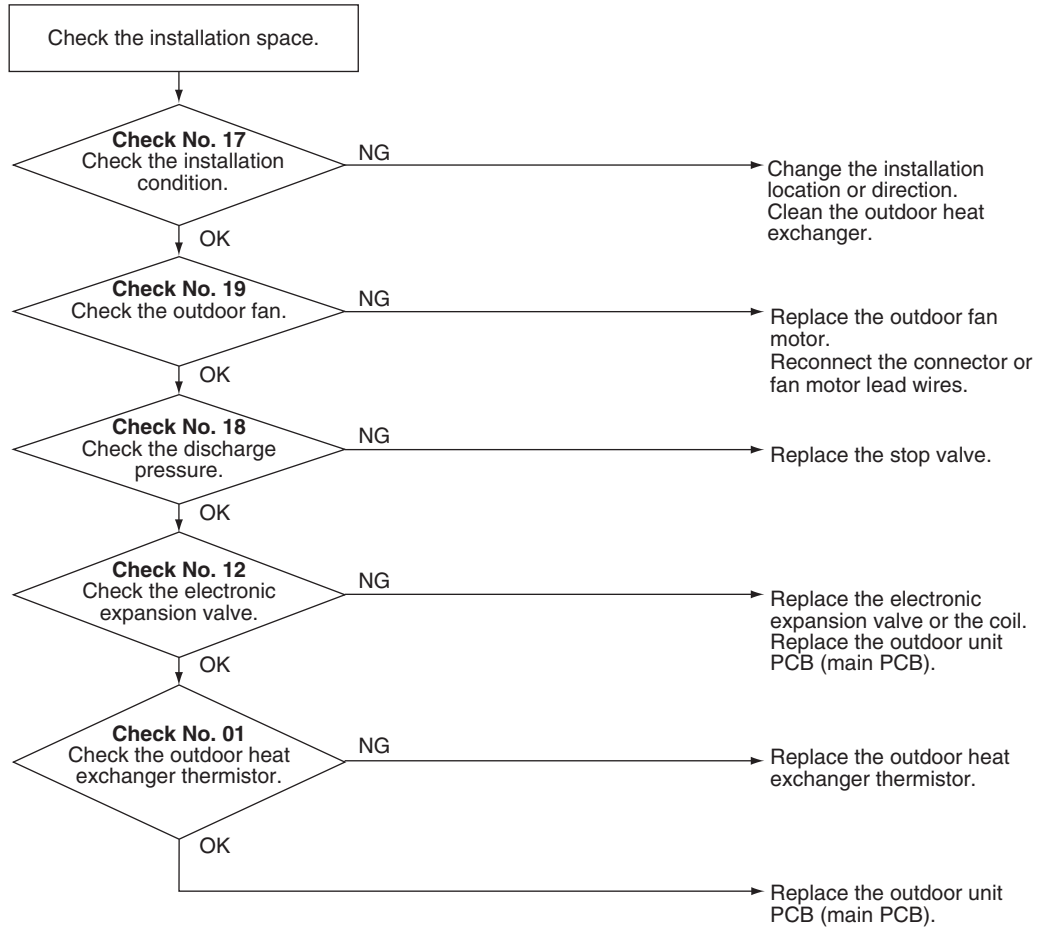

(R20418)



Reference Check No.01 Refer to P.134



Reference Check No.12 Refer to P.136



Reference Check No.17 Refer to P.141



Reference Check No.18 Refer to P.142



Reference Check No.19 Refer to P.142

4.20 System Shutdown due to Temperature Abnormality in Compressor

Error Code

F8

Method of Error Detection

Operation is halted when the temperature detected by the discharge pipe thermistor exceeds the determined limit.

Error Decision Conditions

Temperature exceeds the detection threshold of 127.5°C (261.5°F) during forced cooling operation.

Supposed Causes

- Abnormal operation due to air intrusion
- Defective discharge pipe thermistor

Troubleshooting



Caution

Be sure to turn off the power switch before connecting or disconnecting connectors, or parts may be damaged.

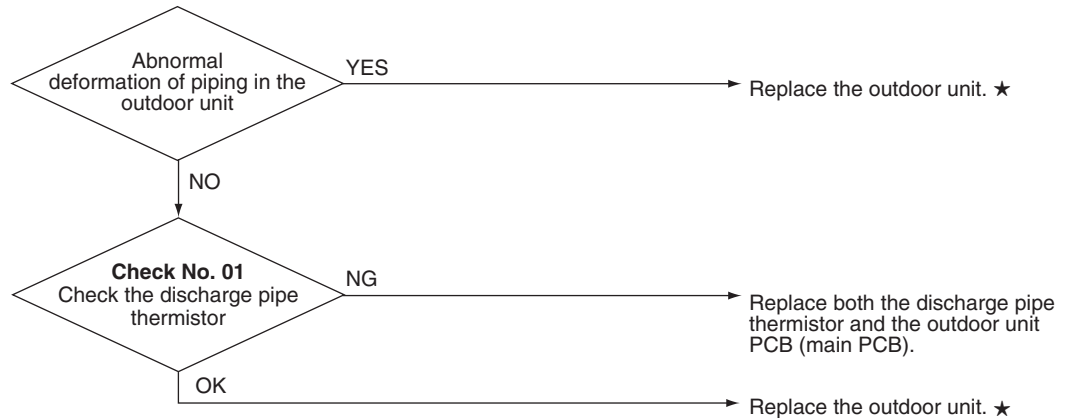

★ Replace the unit as directed in the installation manual, making sure that air does not intrude into the refrigerant pipings.

(R23655)



Reference

Check No.01 Refer to P.134

4.21 Compressor System Sensor Abnormality

Error Code	H7
Method of Error Detection	The system checks the DC current before the compressor starts.
Error Decision Conditions	<ul style="list-style-type: none"> ■ The voltage converted from the DC current before compressor start-up is out of the range 0.5 ~ 4.5 V. ■ The DC voltage before compressor start-up is below 50 V.
Supposed Causes	<ul style="list-style-type: none"> ■ Broken or disconnected harness ■ Defective outdoor unit PCB

Troubleshooting

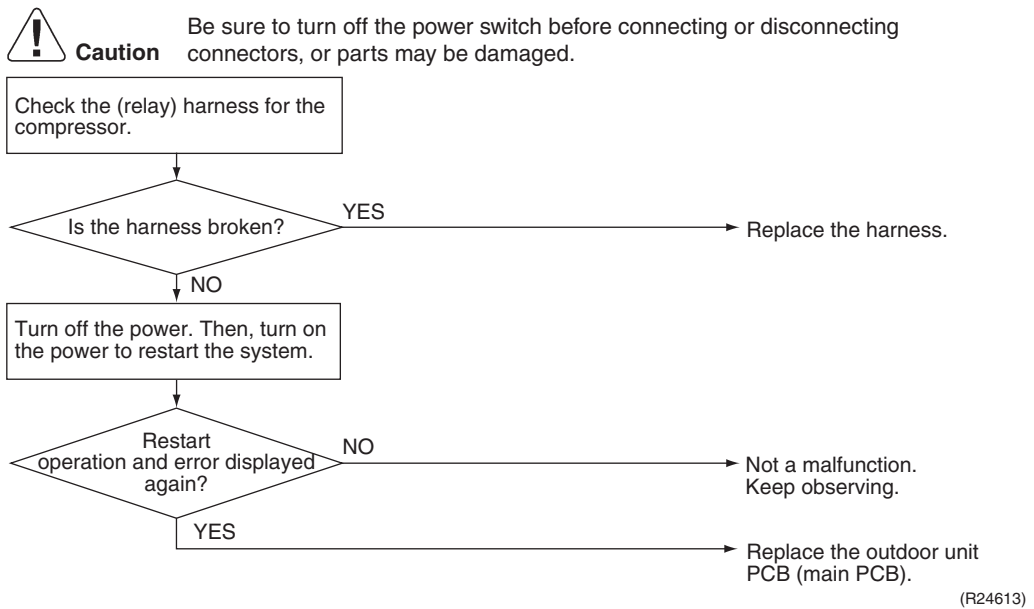

4.22 Position Sensor Abnormality

Error Code	H6
Method of Error Detection	A compressor start-up failure is detected by checking the compressor running condition through the position detection circuit.
Error Decision Conditions	<ul style="list-style-type: none">■ If the error repeats, the system is shut down.■ Reset condition: Continuous run for about 11 minutes without any other error
Supposed Causes	<ul style="list-style-type: none">■ Power supply voltage out of specification■ Disconnection of the compressor harness■ Defective compressor■ Defective outdoor unit PCB■ Start-up failure caused by the closed stop valve■ Input voltage outside the specified range

Troubleshooting



Caution Be sure to turn off the power switch before connecting or disconnecting connectors, or parts may be damaged.

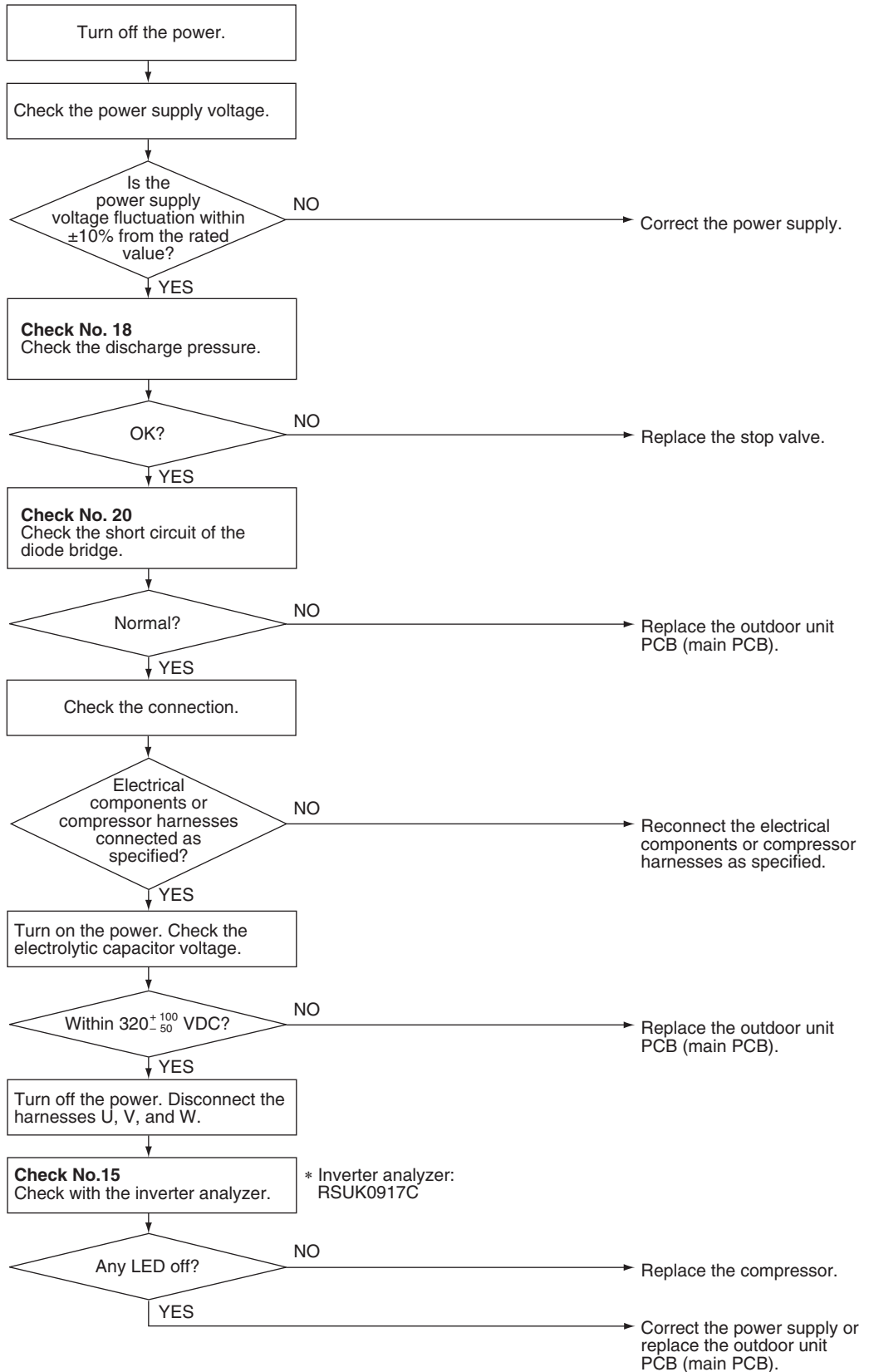

(R22764)

 **Reference** **Check No.15** Refer to P.138

 **Reference** **Check No.18** Refer to P.142

 **Reference** **Check No.20** Refer to P.142

4.23 DC Voltage/Current Sensor Abnormality

Error Code	H2
Method of Error Detection	DC voltage or DC current sensor abnormality is identified based on the compressor running frequency and the input current.
Error Decision Conditions	<ul style="list-style-type: none"> ■ If the error repeats, the system is shut down. ■ Reset condition: Continuous run for about 60 minutes without any other error
Supposed Causes	<ul style="list-style-type: none"> ■ Defective outdoor unit PCB
Troubleshooting	



Caution

Be sure to turn off the power switch before connecting or disconnecting connectors, or parts may be damaged.

Replace the outdoor unit PCB (main PCB).

Troubleshooting

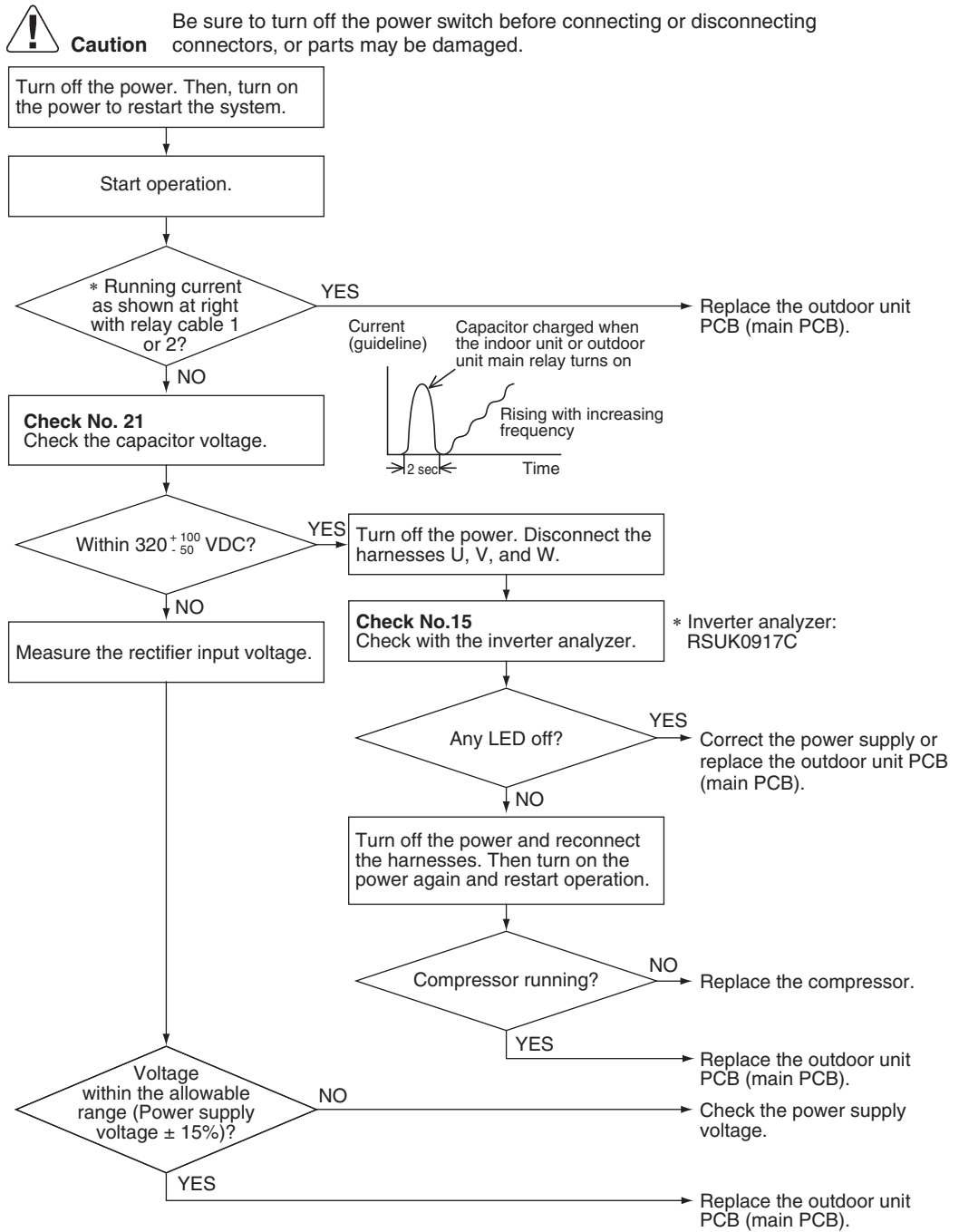

(R23155)

Reference **Check No.15** Refer to P.138

Reference **Check No.21** Refer to P.144

4.24 Thermistor or Related Abnormality (Outdoor Unit)

Error Code	<i>H3, U3, U5, U8, P4</i>
Method of Error Detection	This fault is identified based on the thermistor input voltage to the microcomputer. A thermistor fault is identified based on the temperature sensed by each thermistor.
Error Decision Conditions	<ul style="list-style-type: none"> ■ The voltage between the both ends of the thermistor is either 4.96 V or more, or 0.04 V or less with the power on. ■ <i>U3</i> error is judged if the discharge pipe temperature is lower than the heat exchanger temperature.
Supposed Causes	<ul style="list-style-type: none"> ■ Disconnection of the connector for the thermistor ■ Defective thermistor(s) ■ Defective heat exchanger thermistor in the case of <i>U3</i> error (outdoor heat exchanger thermistor in cooling operation, or indoor heat exchanger thermistor in heating operation) ■ Defective outdoor unit PCB
Troubleshooting	<p>In case of <i>P4</i></p> <div style="display: flex; align-items: center;">  <div style="margin-left: 10px;"> <p>Caution Be sure to turn off the power switch before connecting or disconnecting connectors, or parts may be damaged.</p> </div> </div>

Replace the outdoor unit PCB (main PCB).

P4 : Radiation fin thermistor

Troubleshooting In case of H3, J3, J5, J8



Caution Be sure to turn off the power switch before connecting or disconnecting connectors, or parts may be damaged.

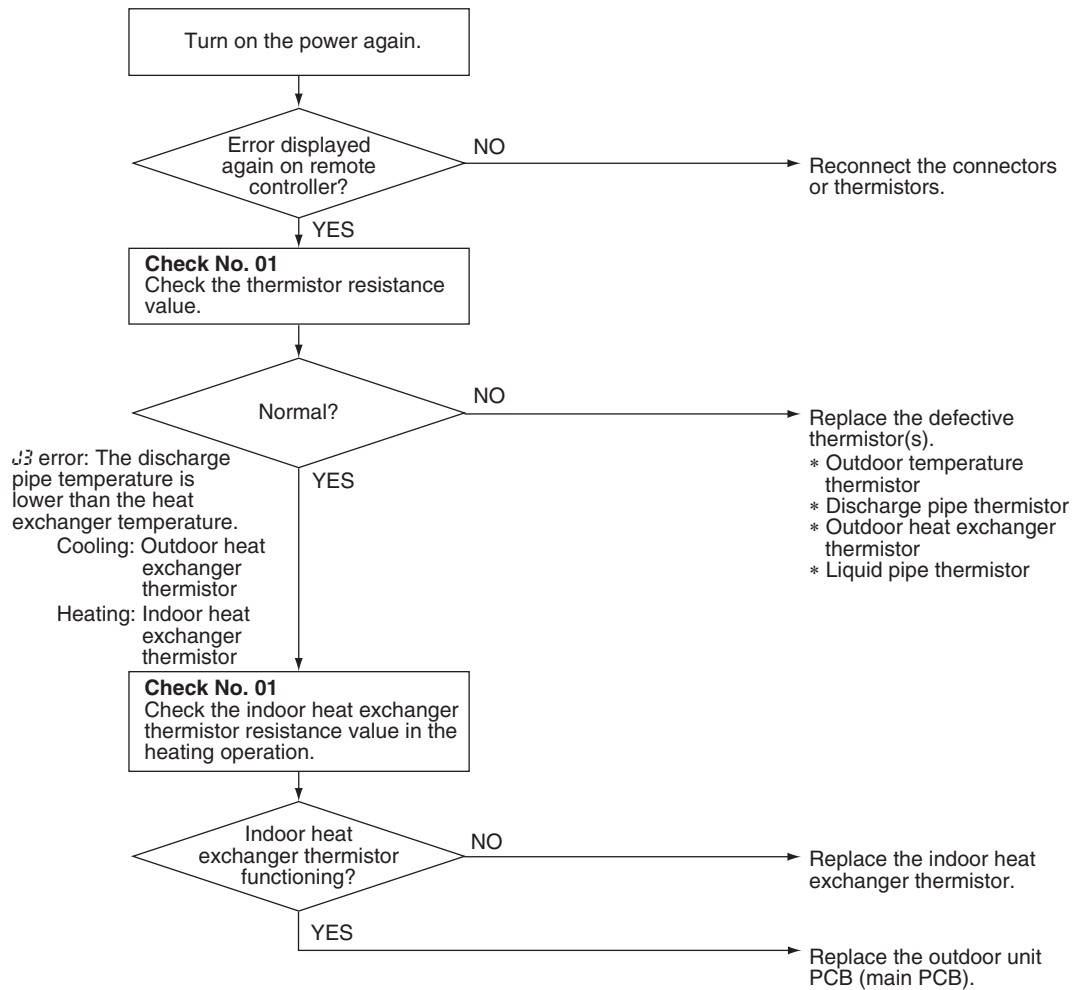

R6000772

- H3 : Outdoor temperature thermistor
- J3 : Discharge pipe thermistor
- J5 : Outdoor heat exchanger thermistor
- J8 : Liquid pipe thermistor



Reference

Check No.01 Refer to P.134

4.25 Electrical Box Temperature Rise

Error Code **L3**

Method of Error Detection An electrical box temperature rise is detected by checking the radiation fin thermistor with the compressor off.

- Error Decision Conditions**
- With the compressor off, the radiation fin temperature is above **A**.
 - The error is cleared when the radiation fin temperature drops below **B**.
 - To cool the electrical components, the outdoor fan starts when the radiation fin temperature rises above **C** and stops when the radiation fin temperature drops below **B**.

	A		B		C	
	(°C)	(°F)	(°C)	(°F)	(°C)	(°F)
09/12 class	122	252	64	147	113	235
18/24 class	92	198	70	158	77	171

- Supposed Causes**
- Defective outdoor fan motor
 - Short circuit
 - Defective radiation fin thermistor
 - Disconnection of connector
 - Defective outdoor unit PCB

Troubleshooting

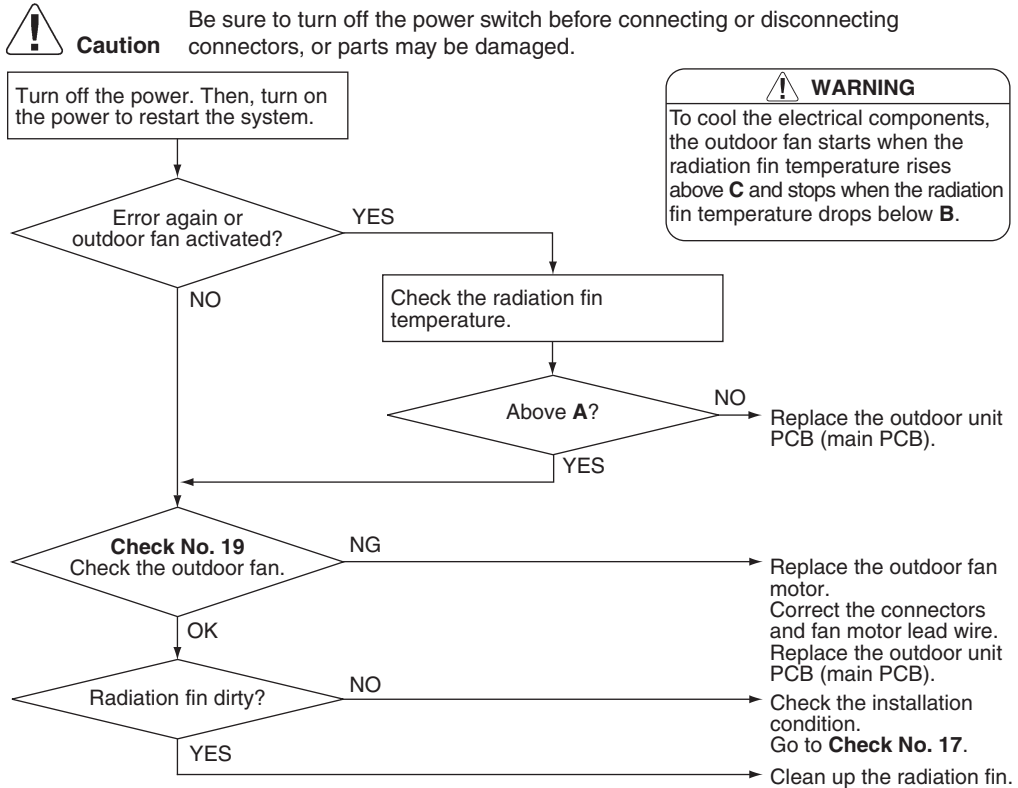

(R22998)

Reference **Check No.17** Refer to P.141

Reference **Check No.19** Refer to P.142

4.26 Radiation Fin Temperature Rise

Error Code

L4

Method of Error Detection

A radiation fin temperature rise is detected by checking the radiation fin thermistor with the compressor on.

Error Decision Conditions

- If the radiation fin temperature with the compressor on is above **A**.
- The error is cleared when the radiation fin temperature drops below **B**.
- If the error repeats, the system is shut down.
- Reset condition: Continuous run for about 60 minutes without any other error

	A		B	
	(°C)	(°F)	(°C)	(°F)
09/12 class	77	171	38	100
18/24 class	82	180	77	171

Supposed Causes

- Defective outdoor fan motor
- Short circuit
- Defective radiation fin thermistor
- Disconnection of connector
- Defective outdoor unit PCB
- Silicone grease not applied properly on the radiation fin after replacing the outdoor unit PCB

Troubleshooting



Caution Be sure to turn off the power switch before connecting or disconnecting connectors, or parts may be damaged.

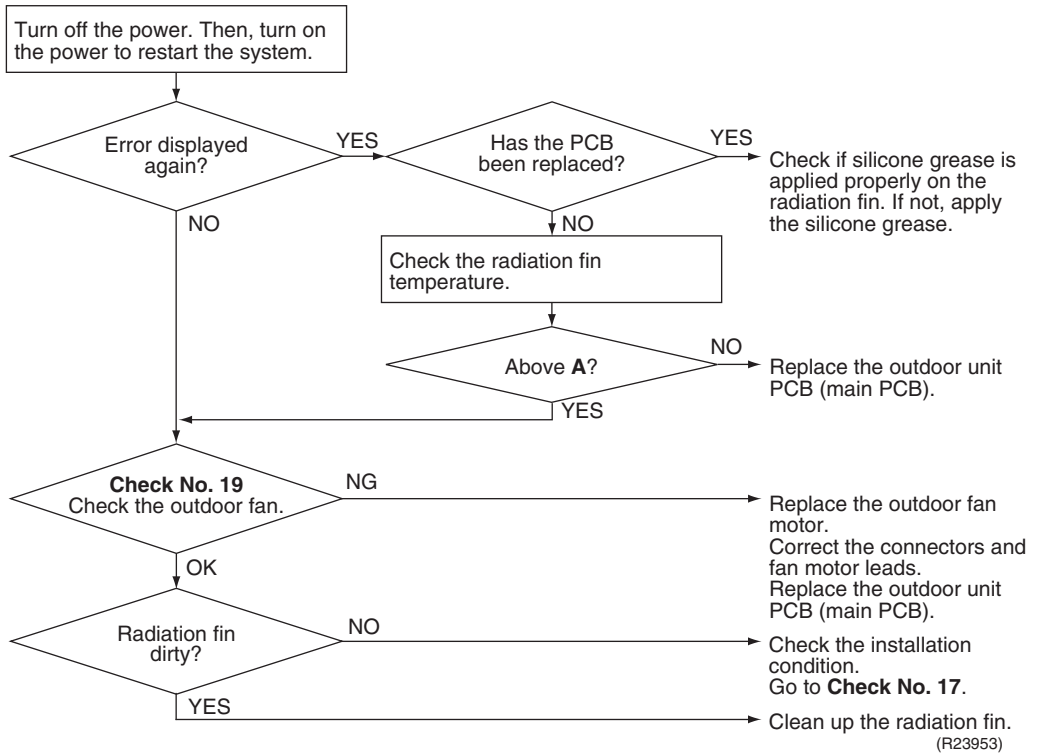

Reference Check No.17 Refer to P.141



Reference Check No.19 Refer to P.142



Note Refer to Silicone Grease on Power Transistor/Diode Bridge on page 158 for details.

4.27 Output Overcurrent Detection

Error Code	L5
Method of Error Detection	An output overcurrent is detected by checking the current that flows in the inverter DC section.
Error Decision Conditions	<ul style="list-style-type: none">■ A position signal error occurs while the compressor is running.■ A rotation speed error occurs while the compressor is running.■ An output overcurrent signal is fed from the output overcurrent detection circuit to the microcomputer.■ If the error repeats, the system is shut down.■ Reset condition: Continuous run for about 11 minutes without any other error
Supposed Causes	<ul style="list-style-type: none">■ Poor installation condition■ Closed stop valve■ Defective power module■ Wrong internal wiring■ Abnormal power supply voltage■ Defective outdoor unit PCB■ Power supply voltage out of specification■ Defective compressor

Troubleshooting



Caution Be sure to turn off the power switch before connecting or disconnecting connectors, or parts may be damaged.

* An output overcurrent may result from wrong internal wiring. If the system is interrupted by an output overcurrent after the wires have been disconnected and reconnected for part replacement, check the wiring again.

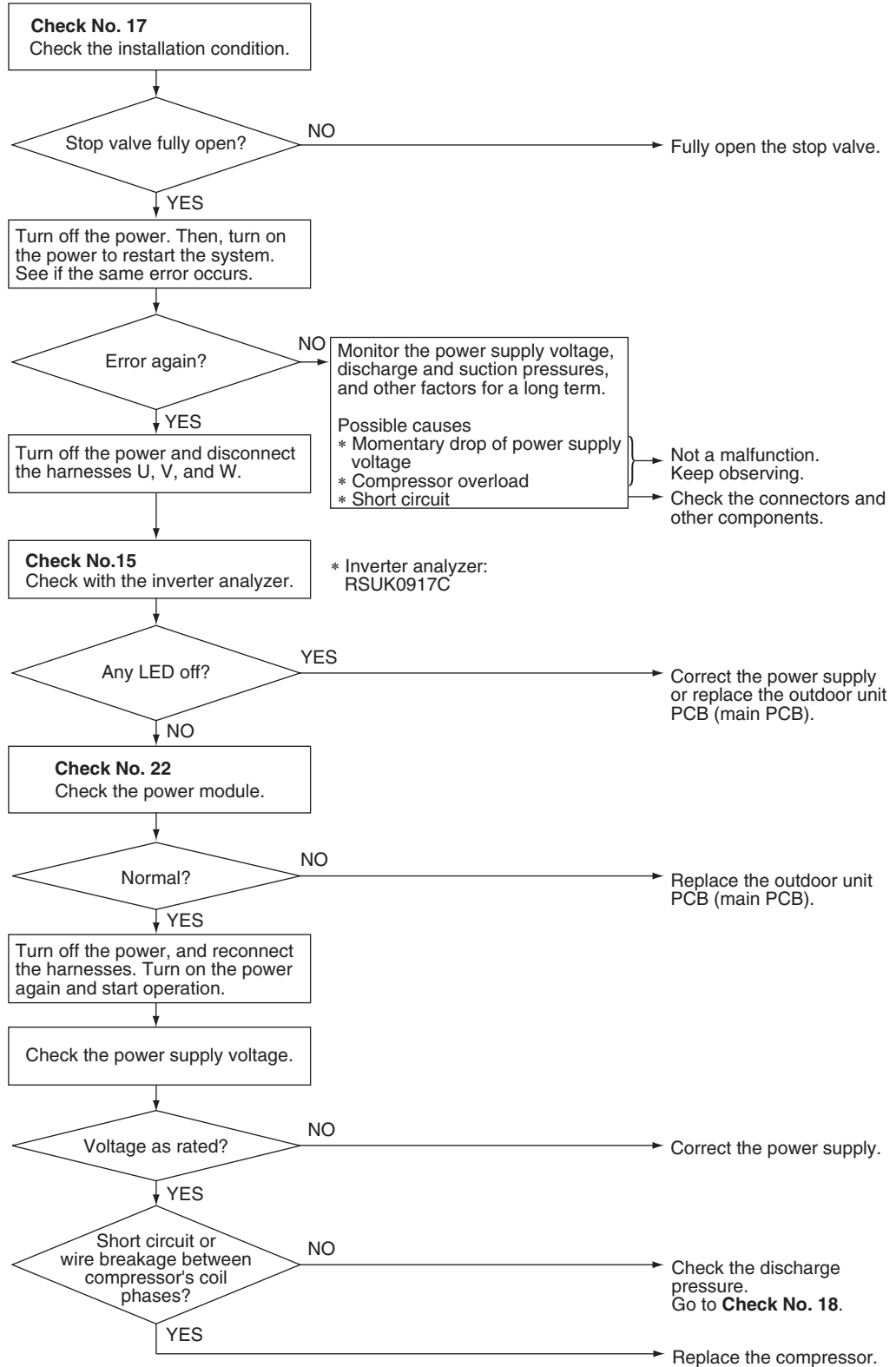

(R21438)

 **Reference** **Check No.15** Refer to P.138

 **Reference** **Check No.17** Refer to P.141

 **Reference** **Check No.18** Refer to P.142

 **Reference** **Check No.22** Refer to P.145

5. Check

5.1 Thermistor Resistance Check

Check No.01

Measure the resistance of each thermistor using multimeter.

The resistance values are defined by below table.

If the measured resistance value does not match the listed value, the thermistor must be replaced.

- Disconnect the connector of thermistor ASSY from the PCB to measure the resistance between the pins using multimeter.
- To check the thermistor soldered on a PCB, disconnect the PCB from other PCB/parts, and measure the resistance between the both ends of soldered thermistor.

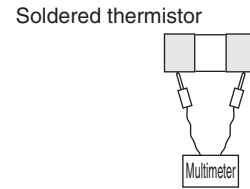
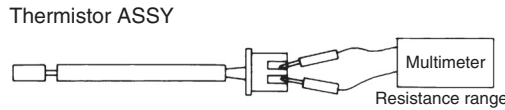

R6000517

Thermistor temperature		Resistance (kΩ)
(°C)	(°F)	R (25°C (77°F)) = 20 kΩ B = 3950 K
-20	-4	197.8
-15	5	148.2
-10	14	112.1
-5	23	85.60
0	32	65.93
5	41	51.14
10	50	39.99
15	59	31.52
20	68	25.02
25	77	20.00
30	86	16.10
35	95	13.04
40	104	10.62
45	113	8.707
50	122	7.176

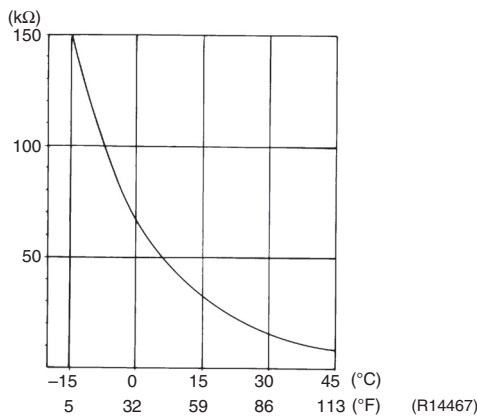

Note

When replacing the defective thermistor(s), replace the thermistor as ASSY.

5.2 Indoor Fan Motor Connector Check

Check No.03

- Fan motor wire breakdown/short circuit check
 1. Check the connector for connection.
 2. Turn the power off.
 3. Check if each resistance at the phases U - V and V - W is within specified range in the table below.

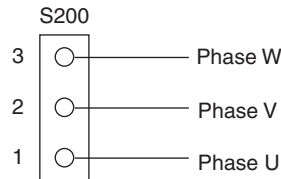

R6000511

	U-V/V-W Resistance (Ω)
09/12 class	41 ~ 57
18/24 class	20 ~ 28

5.3 Power Supply Waveform Check

Check No.11

Measure the power supply waveform between No. 1 and No. 2 on the terminal strip, and check the waveform disturbance.

- Check if the power supply waveform is a sine wave (Fig.1).
- Check if there is waveform disturbance near the zero-cross (sections circled in Fig.2).

[Fig.1]

[Fig.2]

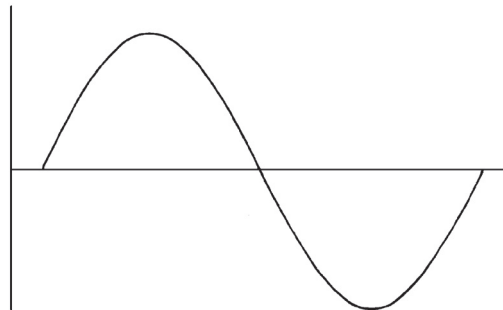

(R1736)

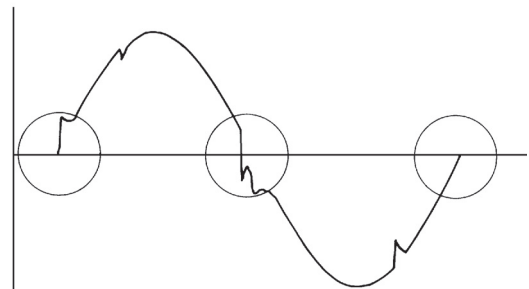

(R1444)

5.4 Electronic Expansion Valve Check

Check No.12

Conduct the following to check the electronic expansion valve (EV).

1. Check if the EV connector is correctly connected to the PCB.
2. Turn the power off and on again, and check if the EV generates a latching sound.
3. If the EV does not generate a latching sound in step 2, disconnect the connector and check the continuity using a multimeter.
4. Check the continuity between the pins 5 - 1, 5 - 2, 5 - 3, 5 - 4 (between the pins 6 - 1, 6 - 2, 6 - 3, and 6 - 4 for the 6P connector models). If there is no continuity between the pins, the EV coil is faulty.
5. If the continuity is confirmed in step 3, the outdoor unit PCB (main PCB) is faulty.

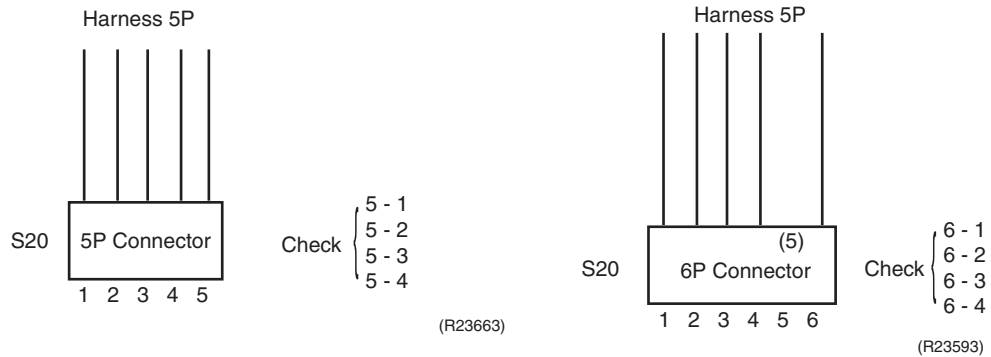

5.5 Four Way Valve Performance Check

Check No.13

< Caution on resetting the power supply >
 * Be sure to wait for 30 sec. or more after turning off the power.

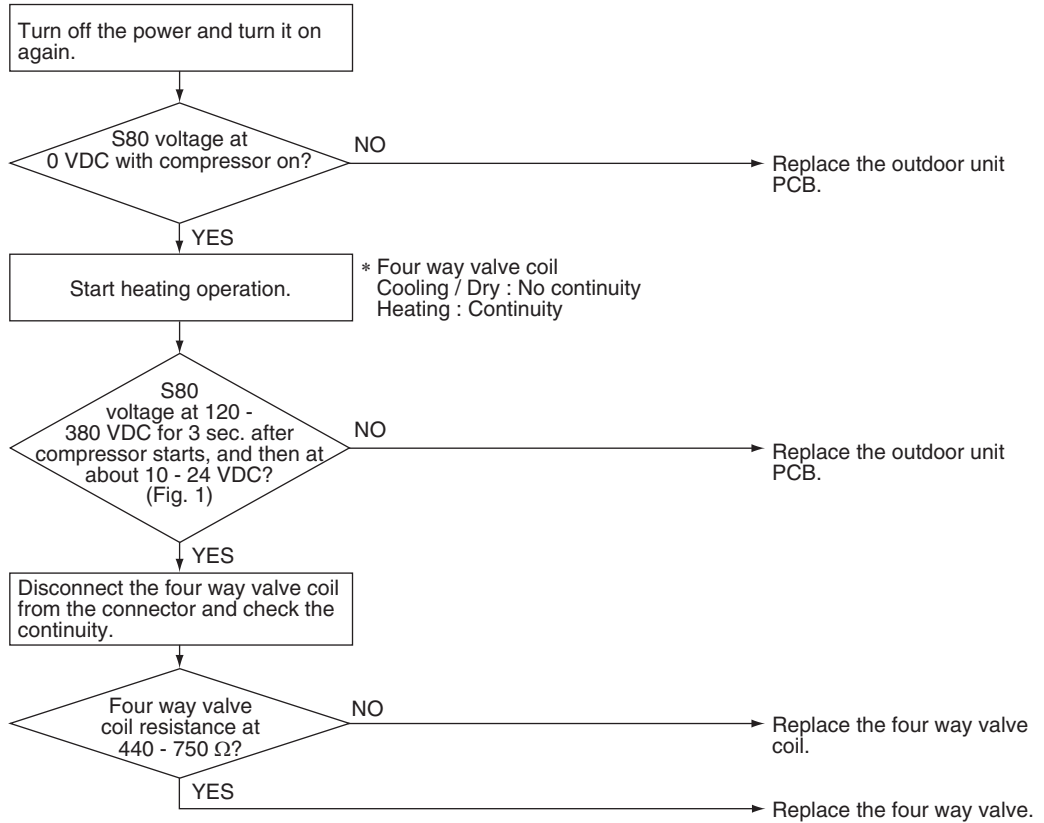

(Fig. 1)

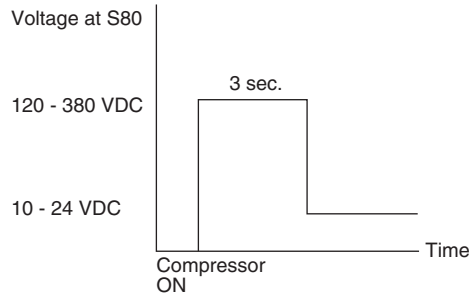

(R25254)

5.6 Inverter Unit Refrigerant System Check

Check No.14

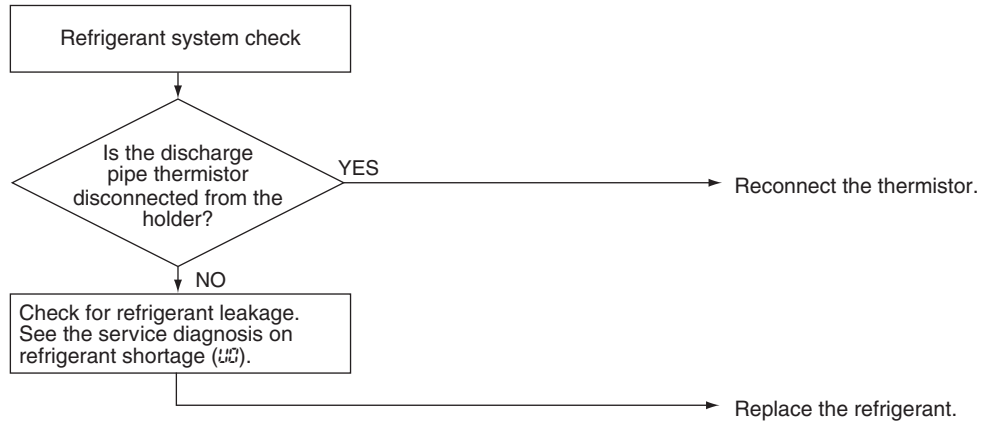

(R15833)

5.7 Inverter Analyzer Check

Check No.15

■ Characteristics

Inverter analyzer: RSUK0917C

If an abnormal stop occurs due to compressor startup failure or overcurrent output when using an inverter unit, it is difficult to judge whether the stop is caused by the compressor failure or some other failure (main PCB, power module, etc.). The inverter analyzer makes it possible to judge the cause of trouble easily and securely. Connect an inverter analyzer as a quasi-compressor instead of compressor and check the output of the inverter.

■ Operation Method

Step 1

Be sure to turn the power off.

Step 2

Install an inverter analyzer instead of a compressor.

Note:

Make sure the charged voltage of the built-in smoothing electrolytic capacitor drops to 10 VDC or below before carrying out the service work.

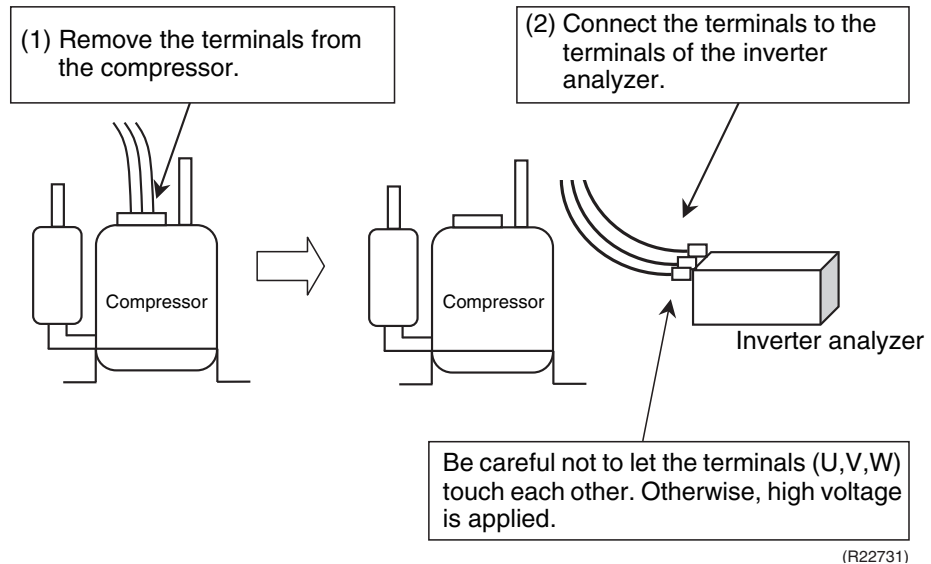

Reference:

If the terminals of the compressor are not FASTON terminals (difficult to remove the wire on the terminals), it is possible to connect wires available on site to the outdoor unit from output side of PCB. Do not connect them to the compressor at the same time, otherwise it may result in incorrect detection.

Step 3

Activate power transistor test operation from the indoor unit.

1. Turn the power on.
2. Select FAN operation with **Mode** button on the remote controller.
3. Press the center of **Temp** button and **Mode** button at the same time.
4. Select ? with **Temp ▲** or **Temp ▼** button.
5. Press **Mode** button to start the power transistor test operation.

■ Diagnose method (Diagnose according to 6 LEDs lighting status of the inverter analyzer.)

1. If all the LEDs are lit uniformly, the compressor is defective.
Replace the compressor.
2. If the LEDs are not lit uniformly, check the power module.
Refer to **Check No.22**.
3. If NG in **Check No.22**, the power module is defective.
Replace the main PCB. The power module is united with the main PCB.
If OK in **Check No.22**, check if there is any solder cracking on the PCB.
4. If any solder cracking is found, replace the PCB or repair the soldered section.
If there is no solder cracking, replace the PCB.



Caution

1. When the output frequency is low, the LEDs blink slowly. As the output frequency increases, the LEDs blink quicker. The LEDs look like they are lit.

- On completion of the inverter analyzer diagnosis, be sure to re-crimp the FASTON terminals. Otherwise, the terminals may be burned due to loosening.

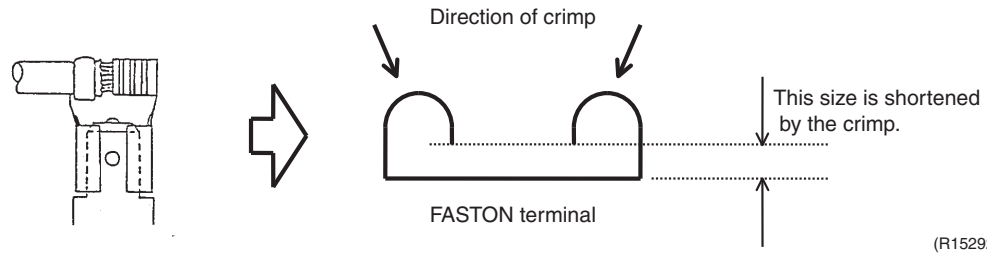

(R15292)

5.8 Rotation Pulse Check on the Outdoor Unit PCB

Check No.16

Outdoor fan motor

■ 09/12 class

Check if the sinusoidal voltage is generated between pins 1 - 3 and 3 - 5 when the fan motor is manually rotated once.

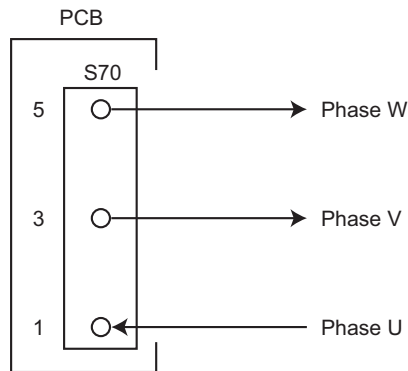

■ 18/24 class

Make sure that the voltage of 320 ± 30 V is applied.

- Set operation OFF and power OFF. Disconnect the connector S70.
- Check that the voltage between the pins 4 - 7 is 320 VDC.
- Check that the control voltage between the pins 3 - 4 is 15 VDC.
- Check that the rotation command voltage between the pins 2 - 4 is $0 \sim 6.5$ VDC.
- Keep operation OFF and power OFF. Connect the connector S70.
- Check whether 4 pulses ($0 \sim 15$ VDC) are output at the pins 1 - 4 when the fan motor is rotated 1 turn by hand.

When the fuse is melted, check the outdoor fan motor for proper function.

If NG in step 2 → Defective PCB → Replace the outdoor unit PCB (main PCB).

If NG in step 4 → Defective Hall IC → Replace the outdoor fan motor.

If OK in both steps 2 and 4 → Replace the outdoor unit PCB (main PCB).

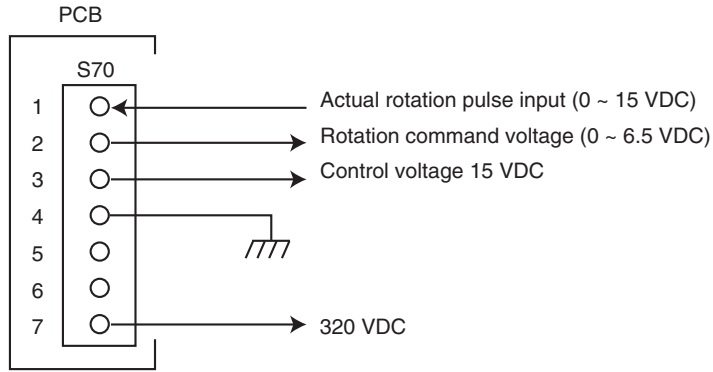

(R25288)

5.9 Installation Condition Check

Check No.17

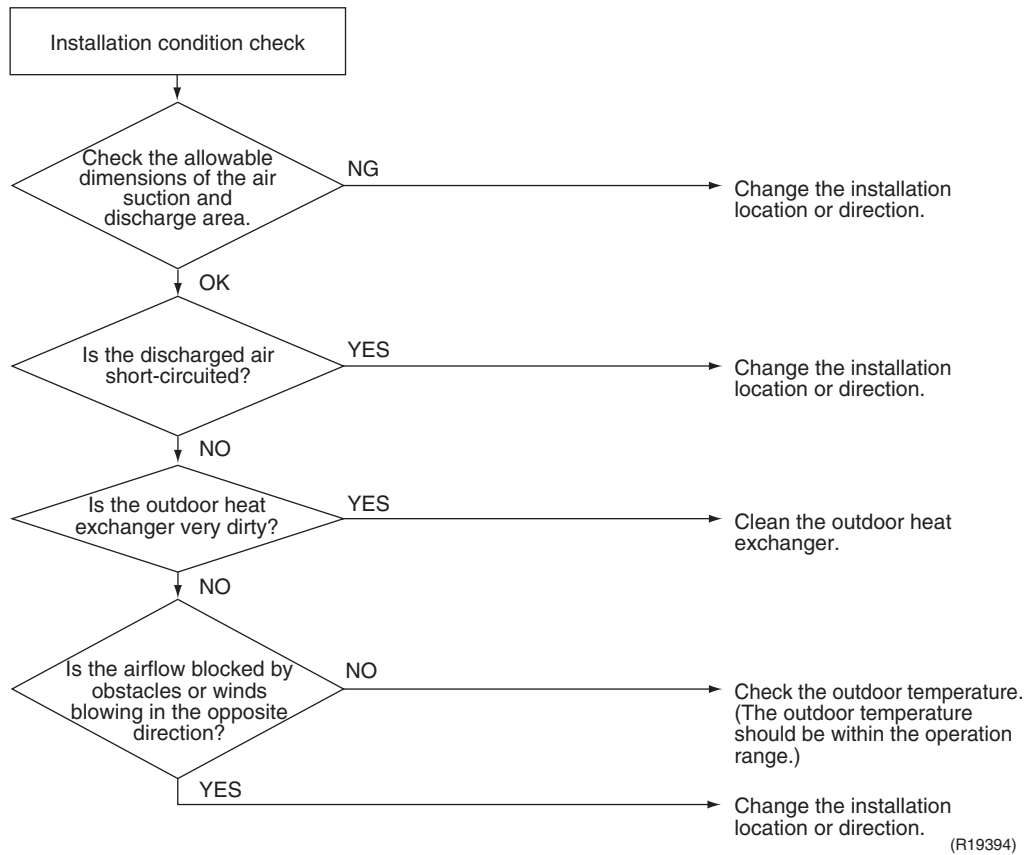

(R19394)

5.10 Discharge Pressure Check

Check No.18

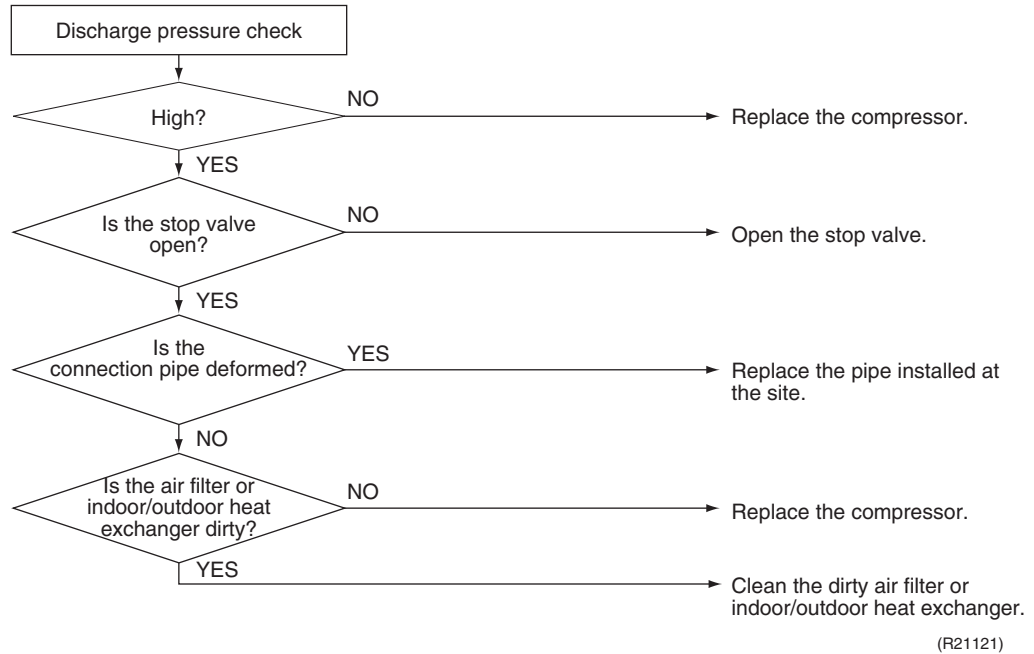

5.11 Outdoor Fan System Check

Check No.19

DC motor

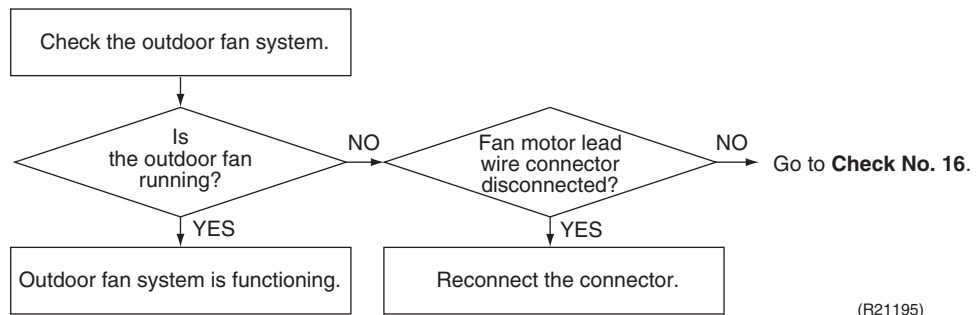

5.12 Main Circuit Short Check

Check No.20

Check to make sure that the voltage between (+) and (-) of the diode bridge (DB1) is about 0 V before checking

- Measure the resistance between the pins of the DB1 referring to the table below.
- If the resistance is ∞ or less than 1 k Ω , short circuit occurs on the main circuit.

Positive terminal (+) of digital multimeter	~ (2, 3)	+ (4)	~ (2, 3)	- (1)
Negative terminal (-) of digital multimeter	+ (4)	~ (2, 3)	- (1)	~ (2, 3)
Resistance is OK.	several k Ω ~ several M Ω			
Resistance is NG.	0 Ω or ∞			

■ 09/12 class

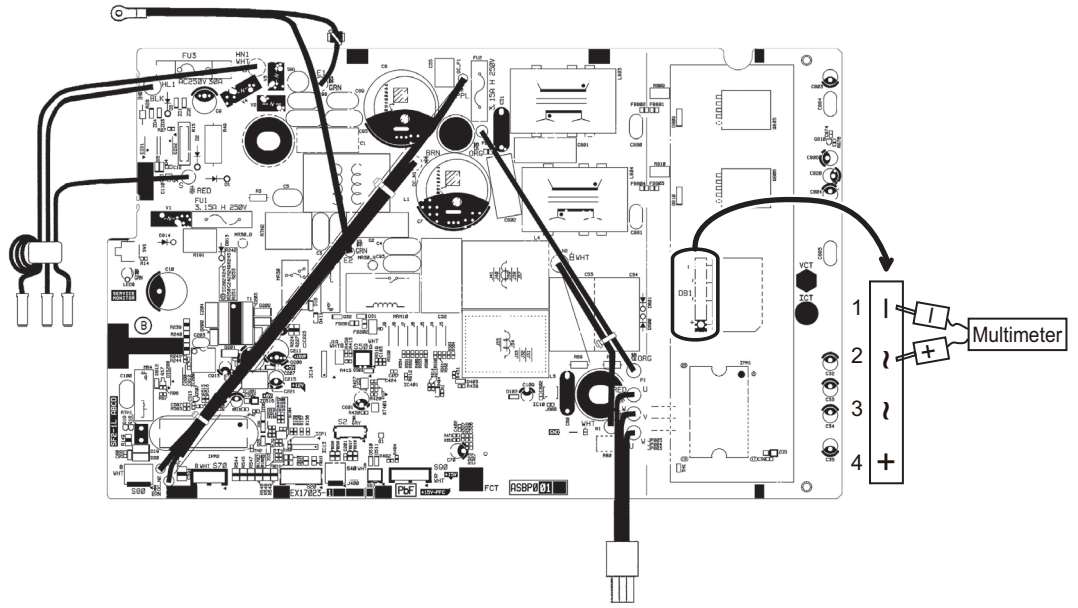

■ 18/24 class

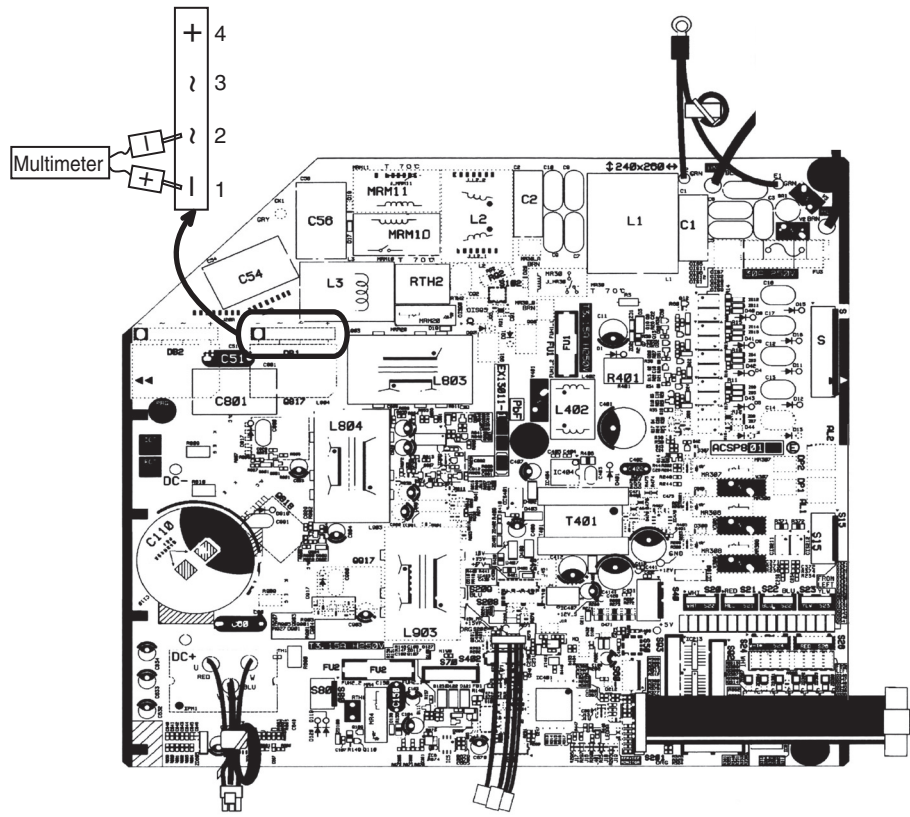

(R24538)

5.13 Capacitor Voltage Check

Check No.21

Before this check, turn the circuit breaker off and wait for 10 minutes for prevention of electric shock.

■ **09/12 class**

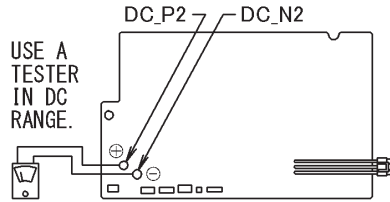

- To prevent electrical shock, use a multimeter to check that the voltage between DC_P2 (+) and DC_N2 (-) is 50 V or less. R6000792

■ **18/24 class**

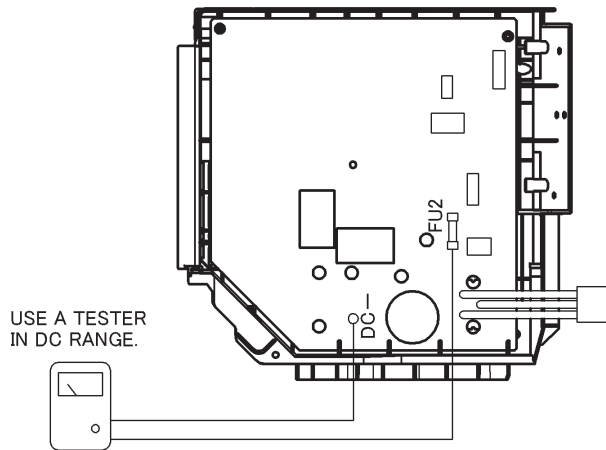

- To prevent an electrical shock, use a multimeter to check that the voltage between FU2 and DC- is 50 V or less. R6000790
- The surface of the test points (FU2, DC-) may be covered with the coating. Be sure to make firm contact between the multimeter probes and the test points.

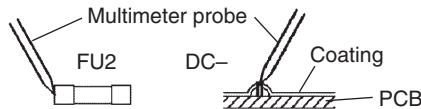

5.14 Power Module Check

Check No.22

Check to make sure that the voltage between (+) and (-) of the power module is about 0 V before checking.

- Disconnect the compressor harness connector from the outdoor unit PCB. To disengage the connector, press the protrusion on the connector.
- Follow the procedure below to measure resistance between the terminals of the power module and the terminals of the compressor with a multimeter. Evaluate the measurement results referring to the following table.

Positive terminal (+) of digital multimeter	Power module (+)	UVW	Power module (-)	UVW
Negative terminal (-) of digital multimeter	UVW	Power module (+)	UVW	Power module (-)
Resistance is OK.	several kΩ ~ several MΩ			
Resistance is NG.	0 Ω or ∞			

- **09/12 class**

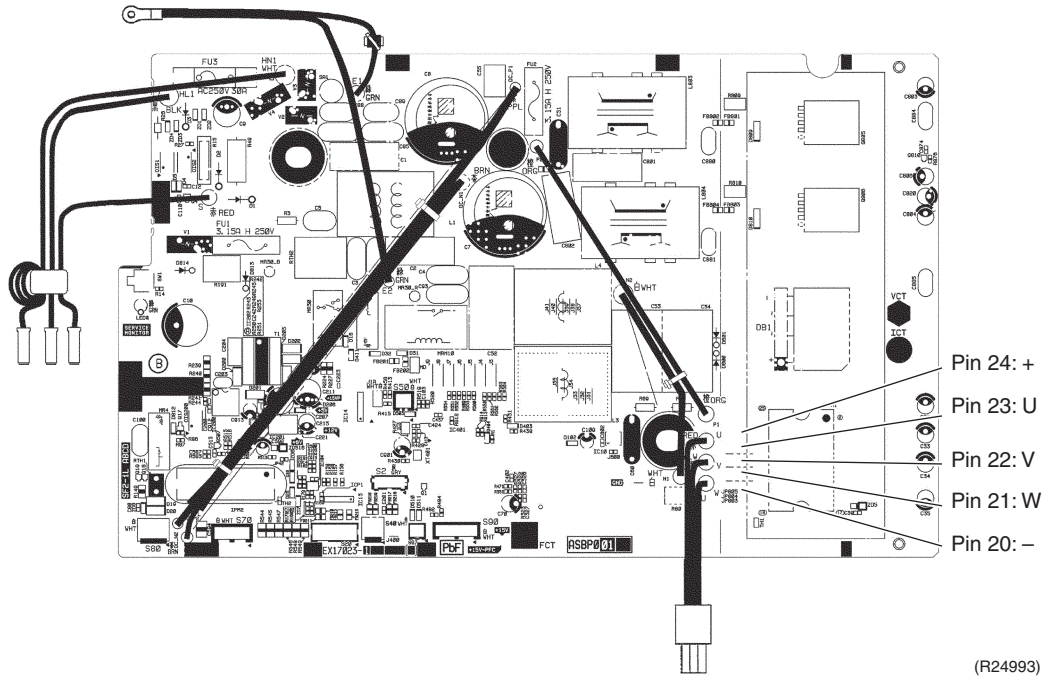

■ 18/24 class

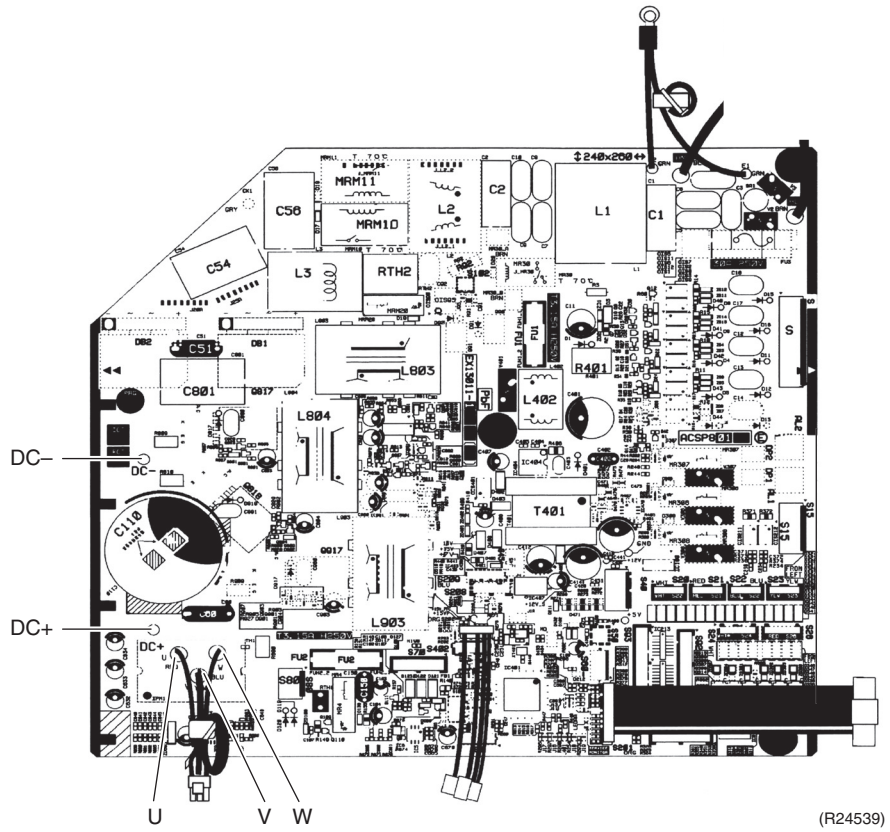

Part 7

Trial Operation and Field Settings

1. Pump Down Operation	148
2. Forced Cooling Operation	149
3. Trial Operation	150
4. Field Settings	152
4.1 Temperature Display Switch	152
4.2 When 2 Units are Installed in 1 Room	152
4.3 Facility Setting (cooling at low outdoor temperature)	153
4.4 Drain Pan Heater	154
4.5 Service Mode of Wireless Remote Controller	155
5. Silicone Grease on Power Transistor/Diode Bridge	158

1. Pump Down Operation

Outline

In order to protect the environment, be sure to conduct pump down operation when relocating or disposing of the unit.

Details

1. Remove the valve caps from the liquid stop valve and the gas stop valve.
2. Carry out forced cooling operation.
3. After 5 to 10 minutes, close the liquid stop valve with a hexagonal wrench.
4. After 2 to 3 minutes, close the gas stop valve and stop the forced cooling operation.

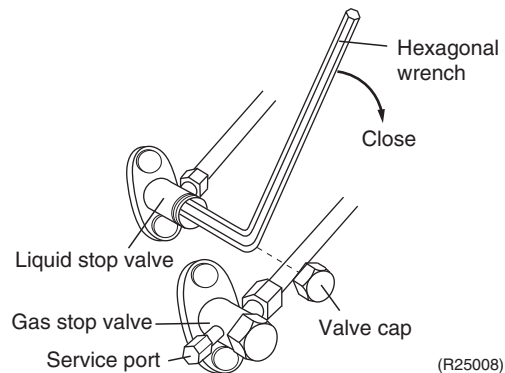

Reference

Refer to Forced Cooling Operation on page 149 for details.

2. Forced Cooling Operation

Outline

The forced cooling operation is allowed when both the following conditions are met.

1. The outdoor unit is not abnormal and not in the 3-minute standby mode.
2. The outdoor unit is not operating.

Protection functions have priority over all other functions during forced cooling operation.

Details

■ With indoor unit ON/OFF switch

Press indoor unit **ON/OFF** switch for at least 5 seconds. The operation will start.

Forced cooling operation will stop automatically after about 15 minutes.

To stop the operation, press indoor unit **ON/OFF** switch.

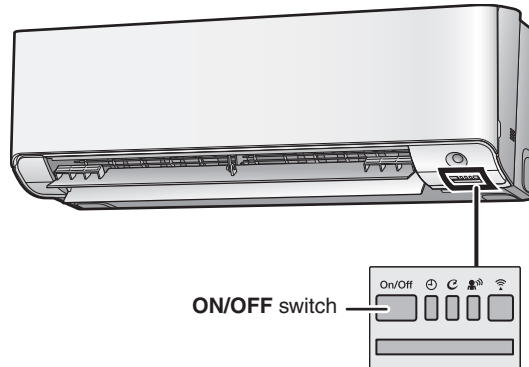

■ With the indoor unit's remote controller

1. Press **Mode** button and select the cooling operation.
 2. Press **On/Off** button to turn on the system.
 3. Press **Temp▲, ▼** buttons and **Mode** button at the same time.
 4. Press **Temp▲, ▼** buttons, select "7", and press **Mode** button for confirmation.
- Forced cooling operation will stop automatically after about 30 minutes.
To stop the operation, press **On/Off** button.

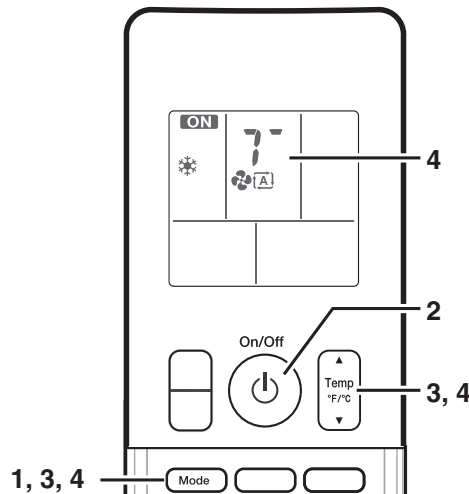

R4003799

R7000227

3. Trial Operation

Outline

Trial operation should be carried out in either cooling or heating operation.

1. Measure the supply voltage and make sure that it is within the specified range.
2. In cooling operation, select the lowest programmable temperature; in heating operation, select the highest programmable temperature.
3. Carry out the trial operation following the instructions in the operation manual to ensure that all functions and parts, such as the movement of the louvers, are working properly.
 - To protect the air conditioner, restart operation is disabled for 3 minutes after the system has been turned off.
4. After trial operation is complete, set the temperature to a normal level (78°F to 82°F (26°C to 28°C) in cooling operation, 68°F to 75°F (20°C to 24°C) in heating operation).

When operating the air conditioner in cooling operation in winter, or heating operation in summer, set it to the trial operation mode using the following method.

Procedure

1. Press **On/Off** button to turn on the system.
2. Press the center of **Temp** button and **Mode** button at the same time.
3. Select 7° (trial operation) with **Temp ▲** or **Temp ▼** button.
4. Press **Mode** button to start the trial operation.
5. Press **Mode** button and select operation mode.
6. Trial operation terminates in about 30 minutes and switches into normal mode. To quit trial operation, press **On/Off** button.

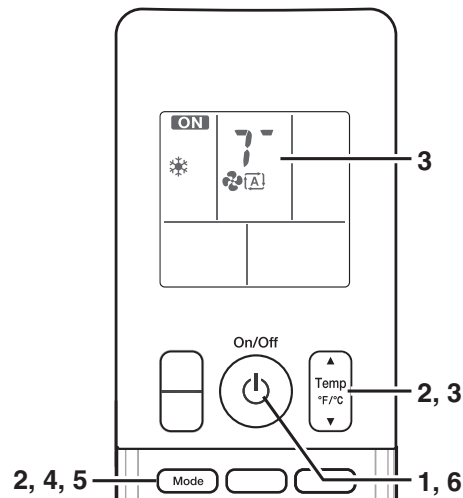

R7000228



Note(s)

- The air conditioner draws a small amount of power in its standby mode. If the system is not to be used for some time after installation, shut off the circuit breaker to eliminate unnecessary power consumption.
- If the circuit breaker trips to shut off the power to the air conditioner, the system will restore the original operation mode when the circuit breaker is turned on again.

Test Items

Test items	Symptom
Indoor and outdoor units are installed securely.	Fall, vibration, noise
No refrigerant gas leaks.	Incomplete cooling/heating function
Refrigerant gas and liquid pipes and indoor drain hose extension are thermally insulated.	Water leakage
Draining line is properly installed.	Water leakage
System is properly grounded.	Electrical leakage
Only specified wires are used for all wiring, and all wires are connected correctly.	No operation or burn damage
Indoor or outdoor unit's air inlet or air outlet are unobstructed.	Incomplete cooling/heating function
Stop valves are opened.	Incomplete cooling/heating function
Indoor unit properly receives remote controller commands.	No operation
Attached SSID sticker with release paper (1 pc.) is given to the user.	Unable to connect to wireless LAN

4. Field Settings

4.1 Temperature Display Switch

Procedure

- Press the upper side of **Temp** button and **On** button at the same time for 5 seconds to change the unit of temperature display.

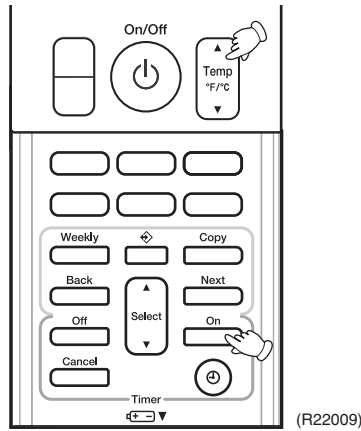

4.2 When 2 Units are Installed in 1 Room

Outline

When 2 indoor units are installed in 1 room, 1 of the 2 indoor units and the corresponding wireless remote controller can be set for different address.

Procedure

1. Remove the battery cover of the remote controller, and cut the address jumper (J4).
2. Press the center of **Temp** button and **Mode** button on the remote controller at the same time.
3. Select # (address setting) with **Temp ▲** or **Temp ▼** button, and press **Mode** button to enter the address setting mode.
Then, the indoor unit operation lamp blinks for 1 minute.
4. Press the indoor unit **ON/OFF** switch while the operation lamp is blinking.
 - If setting could not be carried out completely while the operation lamp was blinking, carry out the setting process once again from the beginning.
 - After setting, press **Mode** button on the remote controller for 5 seconds to return to the normal mode.

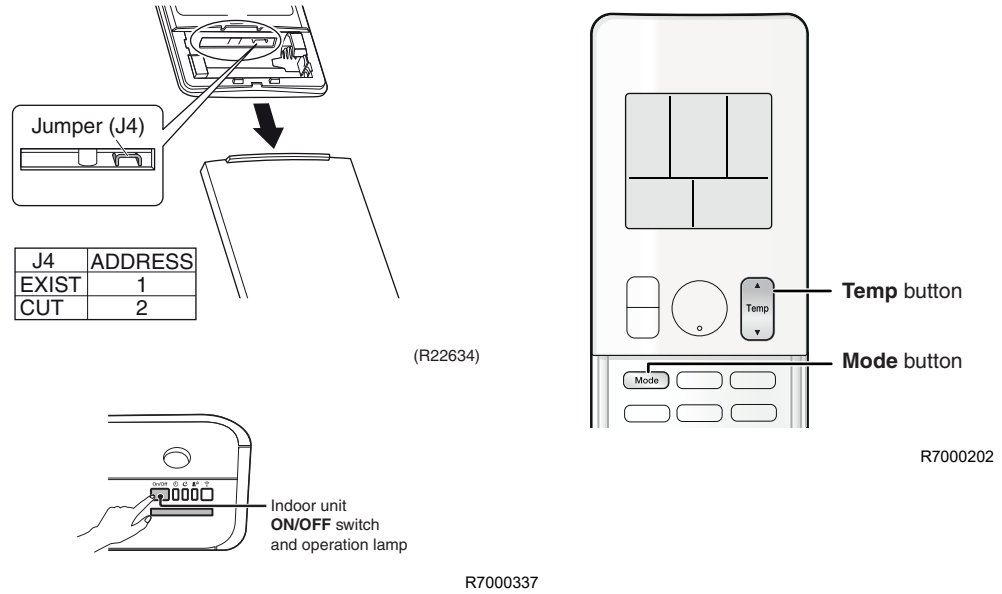

Caution

Replace the remote controller if you cut a jumper unintentionally.

Jumpers are necessary for electronic circuit. Improper operation may occur if you cut any of them.

4.3 Facility Setting (cooling at low outdoor temperature)

Outline

This function is limited only for facilities (the target of air conditioning is equipment such as computers). Never use it in a residence or office (the space where there is a human).

Details

■ **09/12 class**

Cutting jumper 4 (J4) on the circuit board of the outdoor unit will expand the operation range to 14°F (-10°C). Installing an air direction adjustment grille (sold separately) will further extend the operation range to -4°F (-20°C). In these cases, the unit will stop operating if the outdoor temperature falls below -4°F (-20°C), restarting once the temperature rises above this level.

1. Remove the top plate of the outdoor unit. (4 screws)
2. Remove the electrical wiring box cover.
3. Cut the jumper (J4) of the PCB inside.

■ **18/24 class**

Turning on SW5-3 on the PCB of the outdoor unit will extend the operation range to 14°F (-10°C). Installing an air direction adjustment grille (sold separately) will further extend the operation range to -4°F (-20°C). In these cases, the unit will stop operating if the outdoor temperature falls below -4°F (-20°C), restarting once the temperature rises above this level.

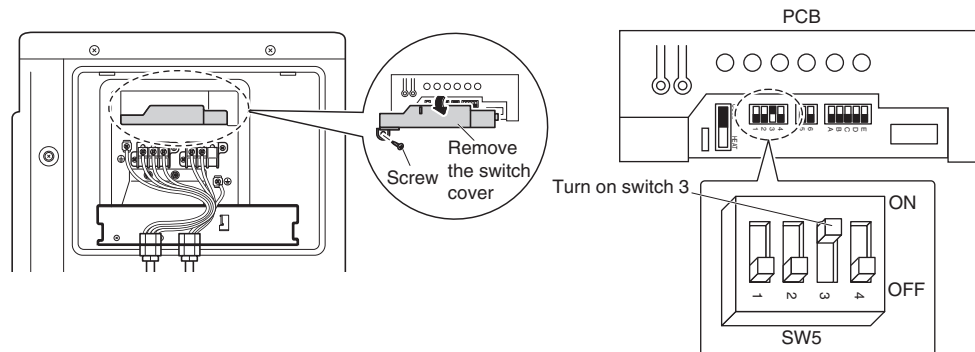

R7000285



Reference

For the location of the jumper, refer to page 20.



Caution

- If the outdoor unit is installed where the heat exchanger of the unit is exposed to direct wind, provide a windbreak wall.
- Intermittent noises may be produced by the indoor unit due to the outdoor fan turning on and off when using facility settings.
- Do not place humidifiers or other items which might raise the humidity in rooms where facility settings are being used. A humidifier might cause dew condensation from the indoor unit outlet vent.
- Cutting jumper 4 (J4)/activating the facility setting sets the indoor fan tap to the highest position. Notify the user about this.



Caution

Replace the PCB if you cut a jumper unintentionally.

Jumpers are necessary for electronic circuit. Improper operation may occur if you cut any of them.

4.4 Drain Pan Heater

In high humidity areas or heavy snow areas, it is recommended to attach a drain pan heater to prevent ice build-up from the bottom frame.

■ **09/12 class**

1. Attach the drain pan heater in accordance with the installation manual included with the drain pan heater.
2. Remove the top plate of the outdoor unit. (4 screws)
3. Remove the electrical wiring box cover.
4. Cut the jumper (J9) of the PCB inside.

■ **18/24 class**

1. Attach the drain pan heater in accordance with the installation manual included with the drain pan heater.
2. Dismount the service lid by removing the 2 screws.
3. Remove the switch cover (1 screw).
4. Turn on SW6-1 on the PCB.

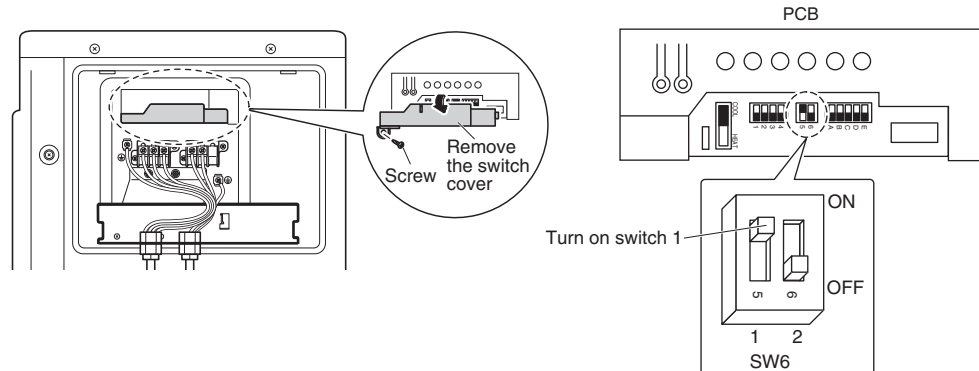

R7000288



Reference

For the location of the jumper, refer to page 20.

4.5 Service Mode of Wireless Remote Controller

The remote controller mode is hierarchized by special conditions and operation content. Refer below for the main hierarchy of the menu.

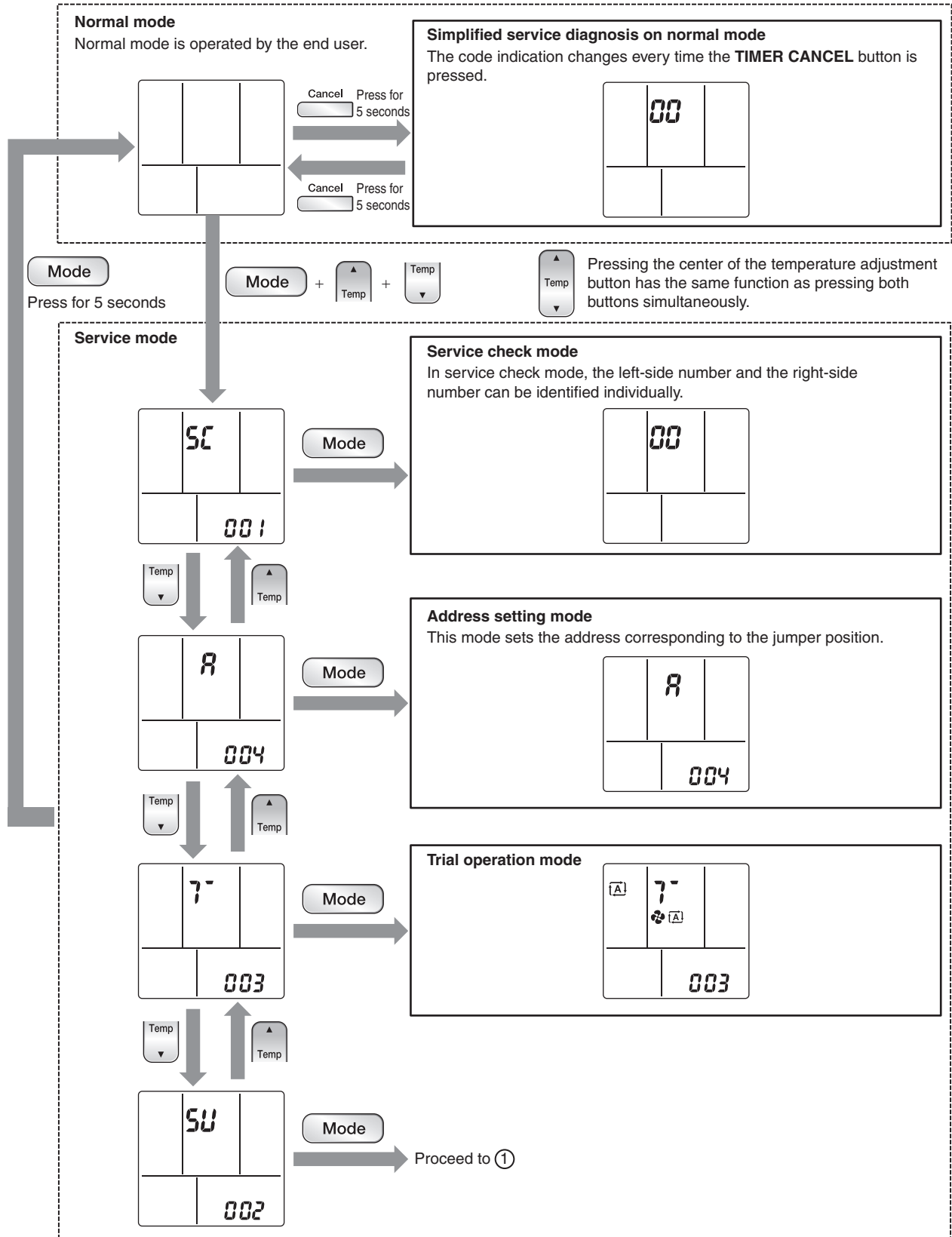

(R24917)

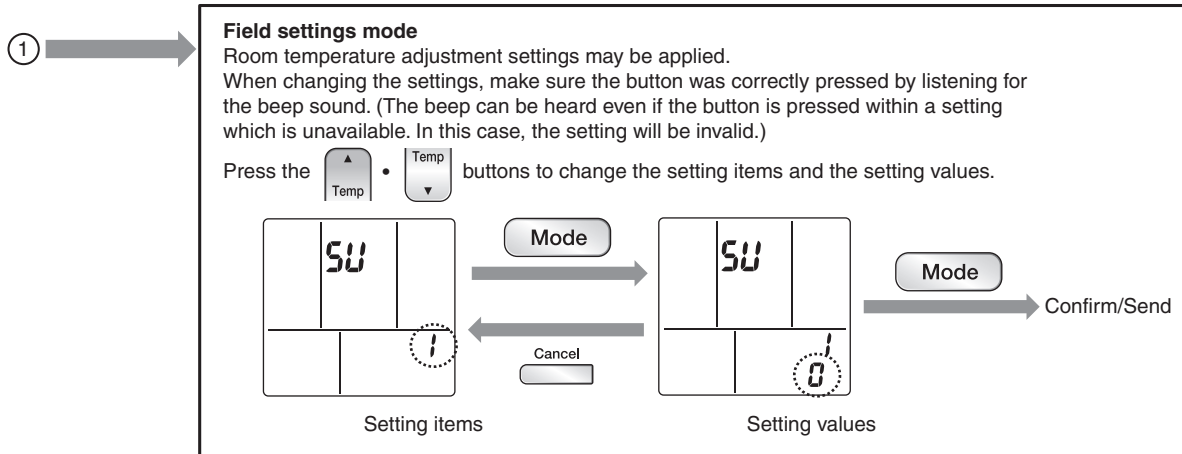

(R24995)

Overview of the Settings

Setting items	Setting options	Factory setting	Contents	
1	Brightness	0: OFF 1: Dark 2: Bright	N/A	Brightness of indoor unit LED lamp
2	Filter cleaning setting	0: Short 1: Long	N/A	Determines the duration/time to display Filter cleaning sign.
3	Suspend	0: OFF 1: ON	1	Activation/Deactivation of Standby electricity saving (suspend function) 0: Power will still be supplied to the outdoor unit PCB after the unit operation stopped. 1: Three minutes after the unit operation stops, the power supply to the outdoor unit PCB is shut off.
4	Dry keep	0: OFF 1: ON	0	Stops the airflow of indoor unit when the thermostat is OFF to prevent increase of room humidity. 0: When thermostat is OFF, the fan rotor will still be OPERATING, hence there is airflow. 1: When thermostat is OFF, the fan rotor will be STOPPED, hence there is no airflow.
5	Preheating control	0: OFF 1: ON	0*	Activation/Deactivation of compressor preheating 0: Deactivation of compressor preheating 1: Activation of compressor preheating
6	Room temperature adjustment (cooling)	0: Low 2 (-2°C) 1: Low 1 (-1°C) 2: Standard (0°C) 3: High 1 (+1°C) 4: High 2 (+2°C)	2	Adjustment of indoor temperature thermistor in cooling operation Used for adjustment of room temperature control.
7	Room temperature adjustment (heating)	0: Low 2 (-2°C) 1: Low 1 (-1°C) 2: Standard (0°C) 3: High 1 (+1°C) 4: High 2 (+2°C)	2	Adjustment of indoor temperature thermistor in heating operation. Used for adjustment of room temperature control.
8	Airflow setting when thermostat off during cooling operation	0: Keep 1: Soft breeze	N/A	Airflow setting when indoor unit thermostat is off. 0: Same airflow as "thermostat on" 1: Lowered to LL tap
9	Wireless/HA priority setting during automatic operation	0: Wireless 1: HA	N/A	Determination of priority control method when HA system is used. 0: Wireless remote controller can be used. 1: Temperature setting from wireless remote controller is disabled.
10	Auto-restart	0: OFF 1: ON	1	This setting decides the operation of the unit when the power supply resumed after a power supply shutdown (i.e. power failure). 0: When the power supply resumes, the unit remains in stopped operation. 1: When the power supply resumes, the unit resumes the operation before the shutdown of power supply.
12	Warmer airflow setting	0: OFF 1: ON	0	This setting makes the discharge airflow temperature warmer.

* 09/12 class: N/A

**Notes**

Set value on remote controller display may differ from the set value of indoor unit itself, as remote controller is not synchronized with indoor unit.

5. Silicone Grease on Power Transistor/Diode Bridge

Outline

Apply the specified silicone grease to the heat radiation part of a power transistor/diode bridge when you replace an outdoor unit PCB. The silicone grease encourages the heat radiation of a power transistor/diode bridge.

Details

1. Wipe off the old silicone grease completely.
2. Apply the silicone grease evenly. See the illustrations below for examples of application.
3. Tighten the screws of the power transistor/diode bridge.
4. Make sure that the heat radiation parts are firmly contacted to the radiation fin.

Note: Smoke emission may be caused by bad heat radiation when the silicone grease is not appropriately applied.

- OK: Evenly applied

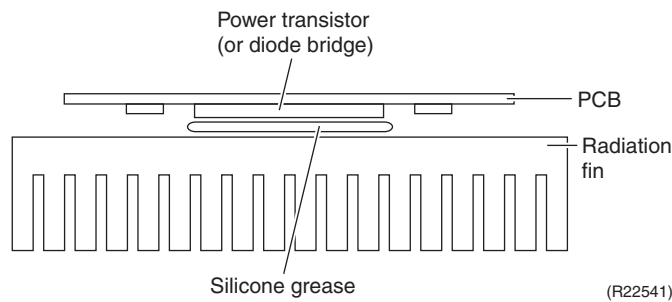

- NG: Not evenly applied

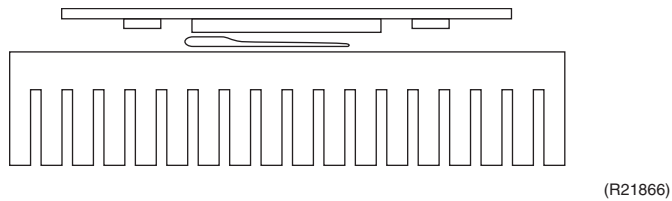

- NG: Foreign matter is stuck.

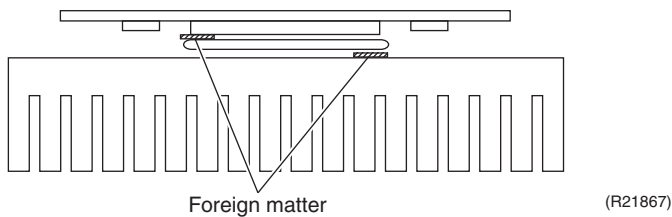

Part 8 Appendix

1. Piping Diagrams.....	160
1.1 Indoor Unit.....	160
1.2 Outdoor Unit.....	161
2. Wiring Diagrams.....	163
2.1 Indoor Unit.....	163
2.2 Outdoor Unit.....	165
3. Operation Limit.....	167

1. Piping Diagrams

1.1 Indoor Unit

FTXM09/12VVJU

FTXM18VVJU

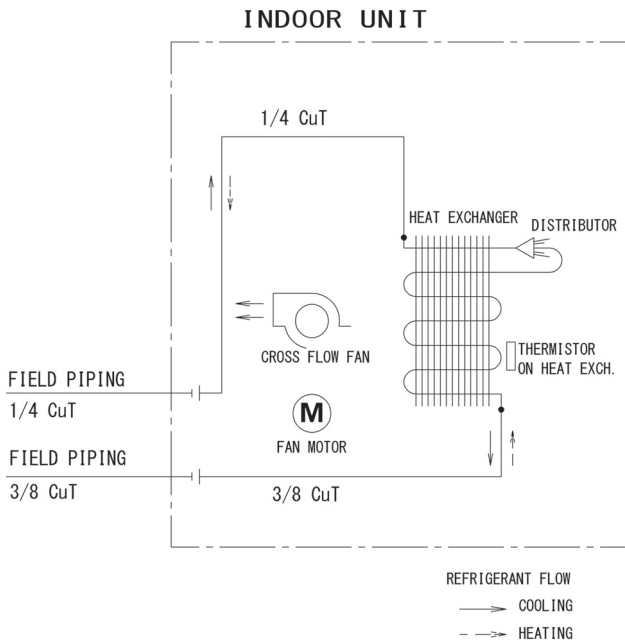

4D132956

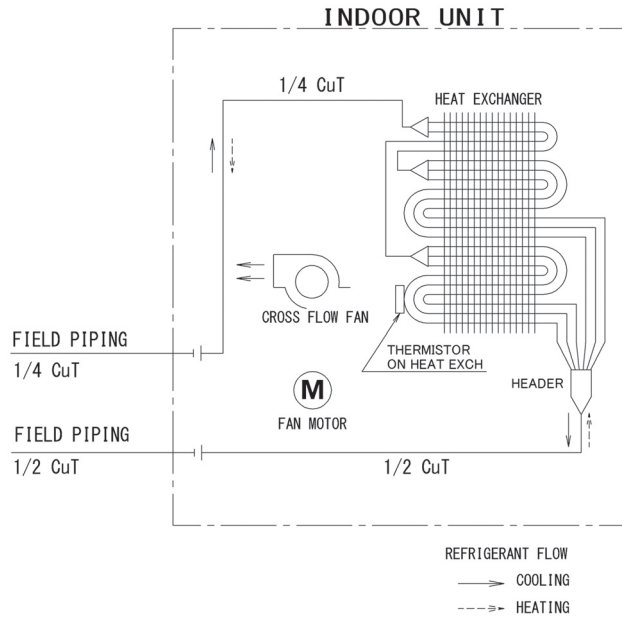

4D132992

FTXM24VVJU

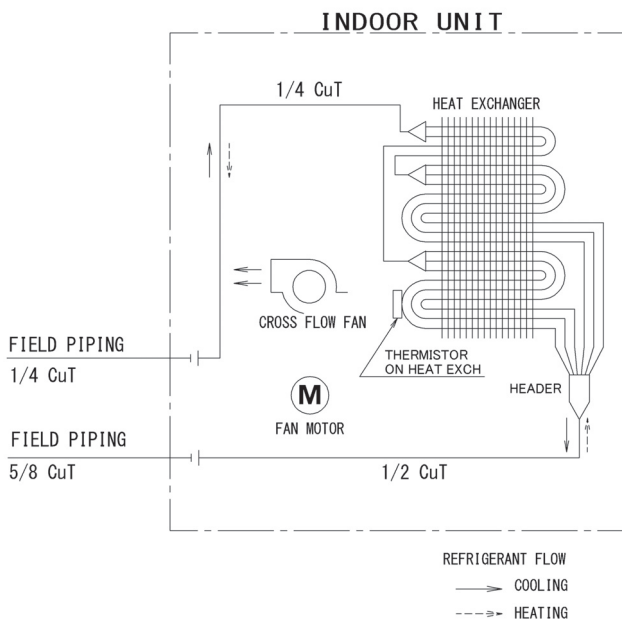

4D132994

1.2 Outdoor Unit

RXM09/12VVJU

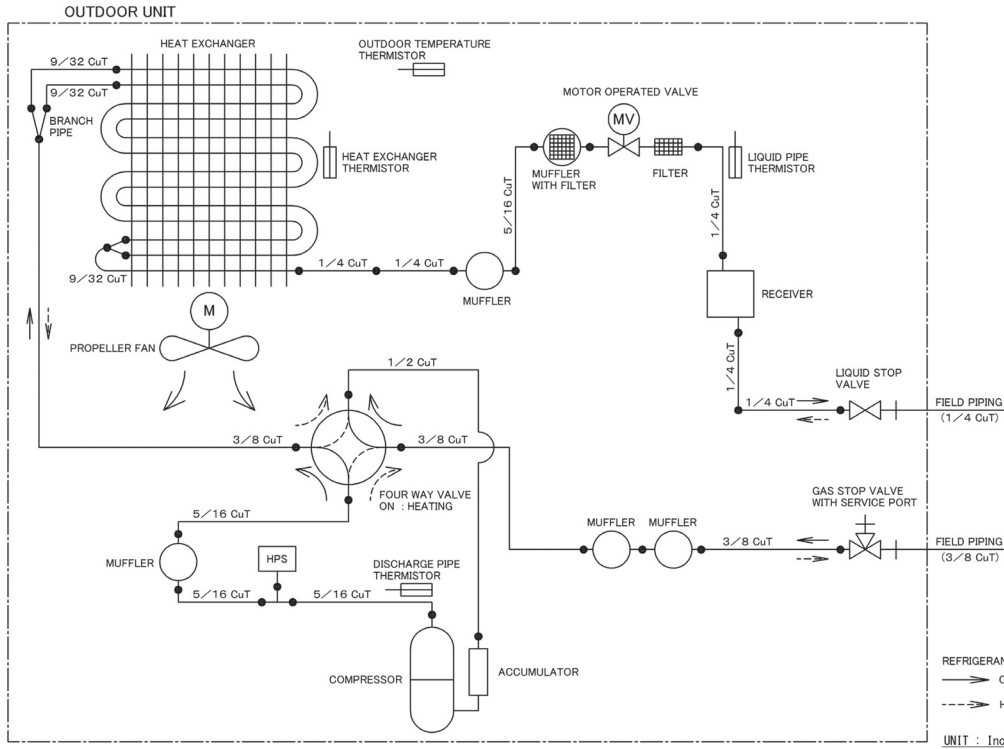

3D131979

RXM18VVJU

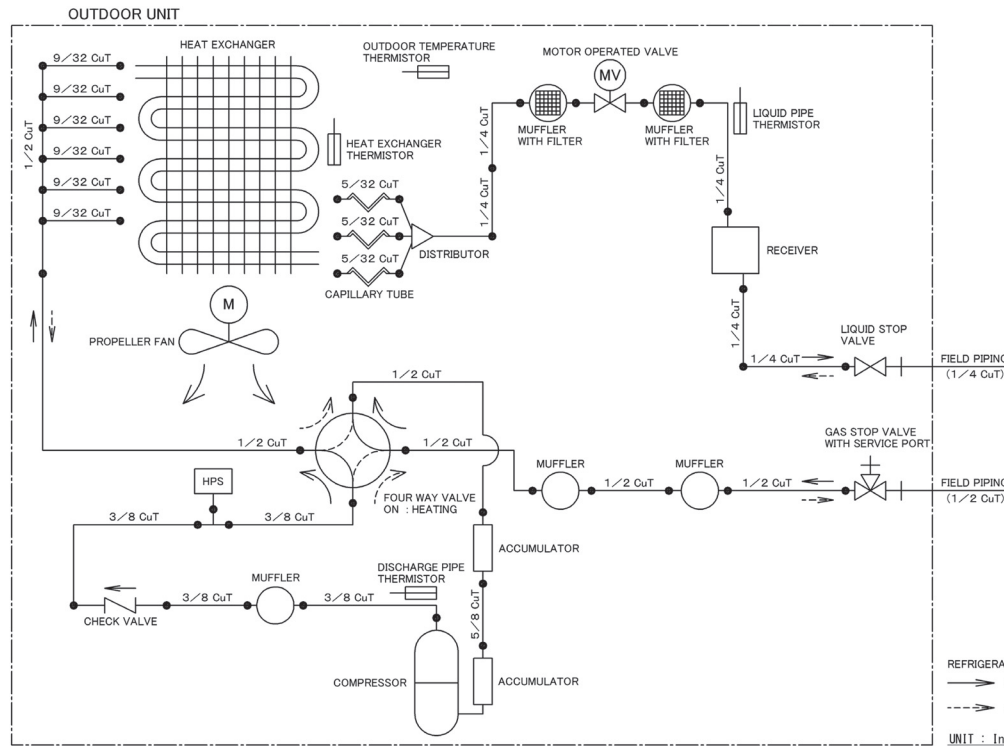

3D132216

RXM24VVJU

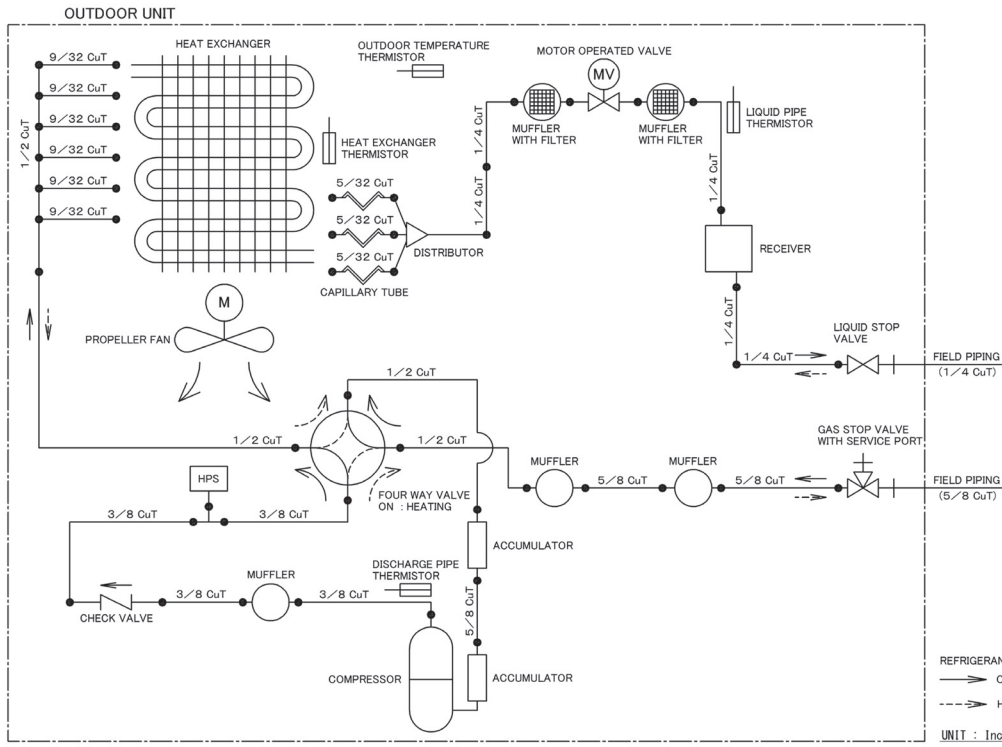

3D132217

2. Wiring Diagrams

2.1 Indoor Unit

FTXM09/12VVJU

- | | |
|-------------------------|------------|
| CONNECTOR | CN, |
| TERMINAL | S16~S920 |
| TERMINAL BLOCK | FG |
| FUSE (T, 3.15A, 250V) | X1M |
| MOTOR (INDOOR FAN) | F1U |
| MOTOR (SWING FLAP) | M1F |
| PRINTED CIRCUIT | M1S~M3S |
| THERMISTOR | A1P~A6P |
| INTELLIGENT EYE SENSOR | R1T, R2T |
| BUTTON SWITCH | IES |
| PILOT LAMP | BS1 |
| SIGNAL RECEIVER | H1P~H5P |
| BUZZER | SR |
| HUMIDITY SENSOR | H1O |
| HEAT EXCHANGER | S1RH |
| MAGNETIC RELAY | E1 |
| RECTIFIER | K1R |
| CAPACITOR | V1R |
| TRANSMITTER CIRCUIT | C101, C102 |
| RECEIVER CIRCUIT | TC |
| PROTECTIVE EARTH/GROUND | RC |
| VARIATOR | R1V |
| FERRITE CORE | Z1C, Z2C |
-
- | | |
|--------------|--------------|
| WIRE COLORS | WHT : WHITE |
| BLK : BLACK | ORA : ORANGE |
| YEL : YELLOW | PIN : PINK |
| RED : RED | PUR : PURPLE |
| BLU : BLUE | |
| GRN : GREEN | |
-
- FIELD WIRING

WIRING DIAGRAM

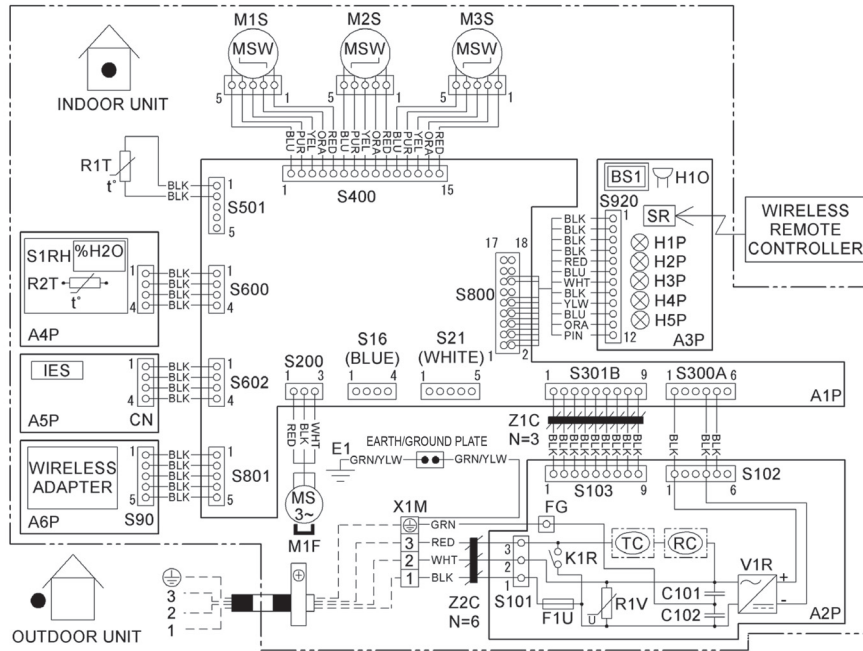

NOTE:
WHEN THE MAIN POWER IS TURNED OFF AND THEN BACK ON AGAIN, OPERATION WILL RESUME AUTOMATICALLY.

C: 3D129547A



Note(s)

- A1P: Control PCB
 - A2P: Power supply PCB
 - A3P: Display/signal receiver PCB
 - A4P: Humidity sensor PCB
 - A5P: INTELLIGENT EYE sensor PCB
 - A6P: Wireless LAN connection PCB
- Refer to page 16 for Printed Circuit Board Connector Wiring Diagram.

FTXM18/24VVJU

WIRING DIAGRAM

- CONNECTOR S16-S920
 - TERMINAL FG
 - TERMINAL BLOCK X1M
 - FUSE (T, 3.15A, 250V) F1U
 - MOTOR (INDOOR FAN) M1F
 - MOTOR (SWING FLAP) M1S-M3S
 - PRINTED CIRCUIT A1P~A6P
 - THERMISTOR R1T, R2T
 - INTELLIGENT EYE SENSOR IES
 - BUTTON SWITCH BS1
 - PILOT LAMP H1P~H5P
 - SIGNAL RECEIVER SR
 - BUZZER H1O
 - HUMIDITY SENSOR S1RH
 - HEAT EXCHANGER E1
 - MAGNETIC RELAY K1R
 - RECTIFIER V1R
 - CAPACITOR C101, C102
 - TRANSMITTER CIRCUIT TC
 - RECEIVER CIRCUIT RC
 - PROTECTIVE EARTH/GROUND R1V
 - VARIATOR Z1C, Z2C
 - FERRITE CORE
-
- WIRE COLORS
 - BLK : BLACK
 - YEL : YELLOW
 - RED : RED
 - BLU : BLUE
 - GRN : GREEN
 - WHT : WHITE
 - ORA : ORANGE
 - PIN : PINK
 - PUR : PURPLE
-
- FIELD WIRING

NOTE:
 WHEN THE MAIN POWER IS
 TURNED OFF AND THEN BACK
 ON AGAIN, OPERATION WILL
 RESUME AUTOMATICALLY.

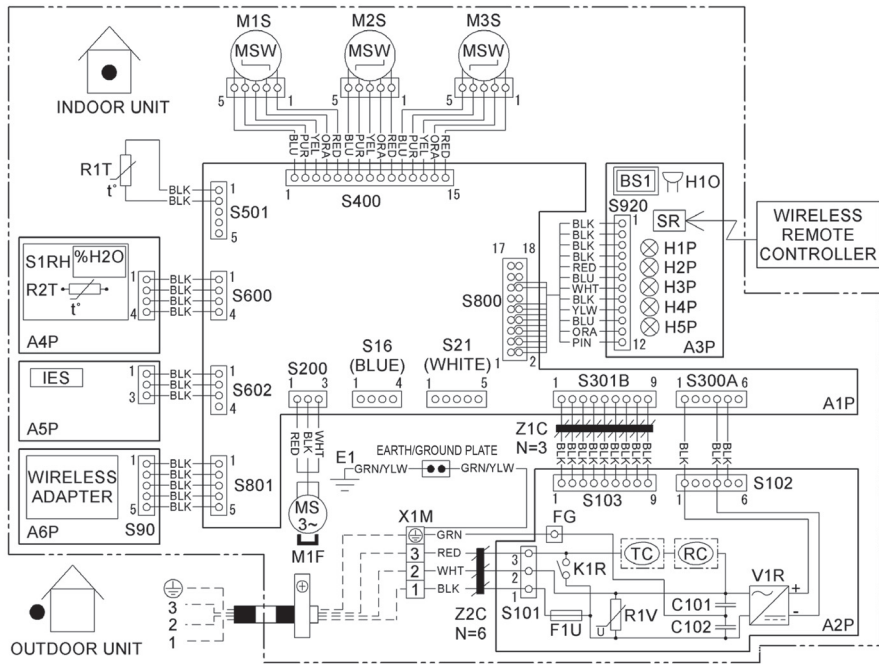

C: 3D129548A



Note(s)

- A1P: Control PCB
 - A2P: Power supply PCB
 - A3P: Display/signal receiver PCB
 - A4P: Humidity sensor PCB
 - A5P: INTELLIGENT EYE sensor PCB
 - A6P: Wireless LAN connection PCB
- Refer to page 16 for Printed Circuit Board Connector Wiring Diagram.

2.2 Outdoor Unit

RXM09/12VVJU

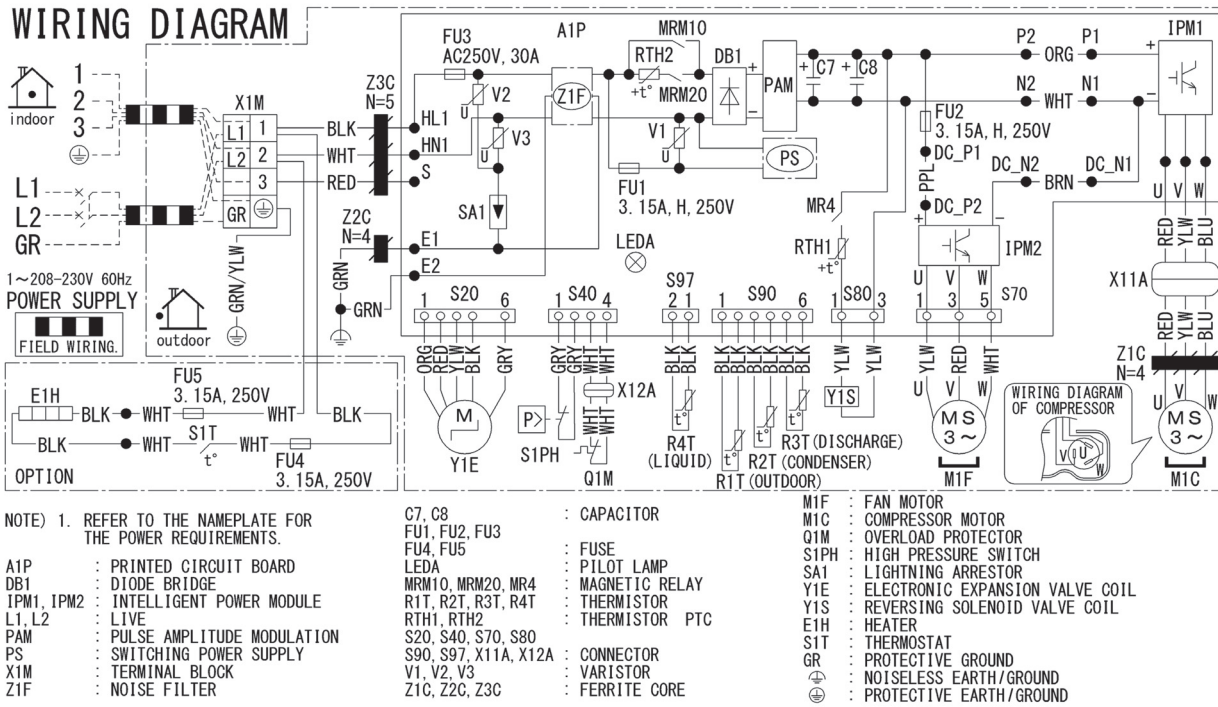

C: 3D129643B



Note(s)

A1P: Main PCB

Refer to page 20 for Printed Circuit Board Connector Wiring Diagram.

RXM18/24VVJU

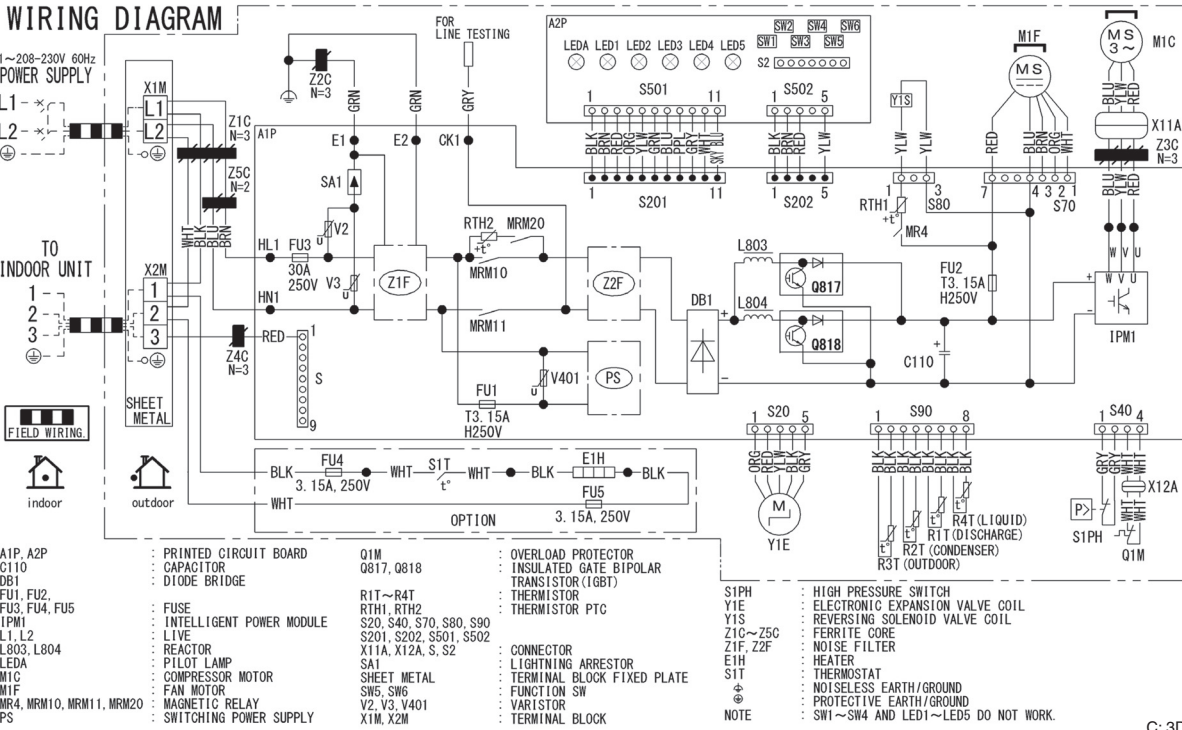

C: 3D129644B



Note(s)

- A1P: Main PCB
- A2P: Service monitor PCB
- Refer to page 21 for Printed Circuit Board Connector Wiring Diagram.

3. Operation Limit

RXM09/12/18/24VVJU

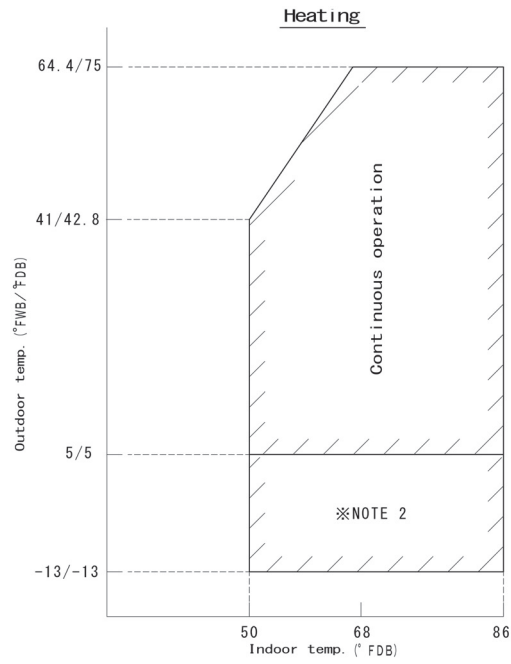
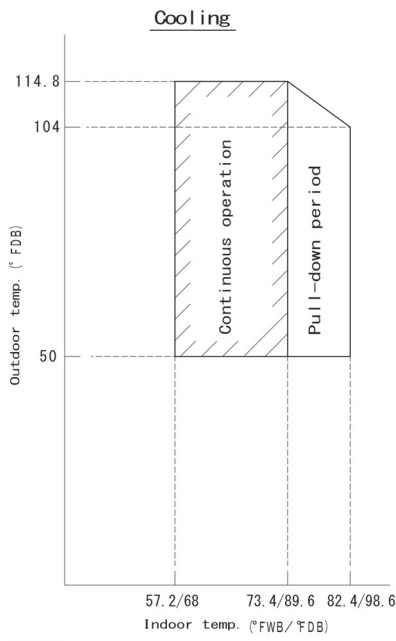

Notes:

- The graphs are based on the following conditions.
 - Equivalent piping length 25ft
 - Level difference 0ft
 - Air flow rate High

2. In high humidity areas or heavy snow areas, it is recommended to attach a drain pan heater to prevent ice build-up from the bottom frame. Refer to the installation manual in detail of setting.

3D133582A

Warning

- Daikin products are manufactured for export to numerous countries throughout the world. Prior to purchase, please confirm with your local authorized importer, distributor and/or retailer whether this product conforms to the applicable standards, and is suitable for use, in the region where the product will be used. This statement does not purport to exclude, restrict or modify the application of any local legislation.
- Ask a qualified installer or contractor to install this product. Do not try to install the product yourself. Improper installation can result in water or refrigerant leakage, electrical shock, fire or explosion.
- Use only those parts and accessories supplied or specified by Daikin. Ask a qualified installer or contractor to install those parts and accessories. Use of unauthorized parts and accessories or improper installation of parts and accessories can result in water or refrigerant leakage, electrical shock, fire or explosion.
- Read the user's manual carefully before using this product. The user's manual provides important safety instructions and warnings. Be sure to follow these instructions and warnings.

If you have any inquiries, please contact your local importer, distributor and/or retailer.

Cautions on product corrosion

1. Air conditioners should not be installed in areas where corrosive gases, such as acid gas or alkaline gas, are produced.
2. If the outdoor unit is to be installed close to the sea shore, direct exposure to the sea breeze should be avoided. If you need to install the outdoor unit close to the sea shore, contact your local distributor.

© All rights reserved