

UP TO 17.2 SEER2
1½ TO 5 TONS

GOODMAN SD (SIDE DISCHARGE)
HIGH-EFFICIENCY,
COMMUNICATING, VARIABLE-SPEED,
INVERTER DRIVEN
R-32 SPLIT SYSTEM AIR CONDITIONER

■ **Contents**

Nomenclature.....2
 Product Specifications.....3
 Expanded Cooling Data.....5
 Performance Data27
 Sound Data31
 Sound Power.....31
 Quiet Mode.....32
 Sound Pressure.....33
 AHRI Ratings (see note).....34
 Wiring Diagram35
 Dimensions38
 Accessories40



R32

■ **Standard Features**

- Variable-speed swing compressors
- Quiet digitally commutated fan motor
- High-density compressor sound blanket
- Compatible with Goodman connected thermostat and other Goodman communicating equipment
- Proprietary control algorithmic logic
- In communicating mode, only two low-voltage wires to outdoor unit required
- Diagnostic indicator lights, seven-segment LED display, and fault code storage
- Proprietary Inside intelligence for diagnostics
- Quiet-mode- provides enhanced acoustical comfort, up to 3 different sound levels (as low as 45 dBA)
- Field-selectable boost mode increases compressor speed during unusually high loads
- Field-installed bi-flow filter drier
- Coil and ambient temperature sensors
- Suction pressure transducer
- Sweat connection service valves with easy access to gauge ports
- AHRI Certified; ETL Listed

■ **Cabinet Features**

- Heavy-gauge galvanized steel cabinet with grille-style sound control side design
- Custom Ivory white powder-paint finish
- High corrosion-resistant (ZAM®), unpainted steel bottom frame and legs
- 500-hour salt-spray tested
- Wire fan discharge grille
- Top and side maintenance access
- When properly anchored, meets the 2023 Florida Building Code unit integrity requirements for hurricane-type winds (Anchor bracket kits available.)



* Complete warranty available from your local dealer or at www.franklinhvacsystems.com. To receive the 10-Year Unit Replacement Limited Warranty (good for as long as you own your home) and 10-Year Parts Limited Warranty, online registration must be completed within 60 days of installation. Online registration is not required in California, Florida, or Québec. The duration of warranty coverages in Texas and Florida differs in some cases. Changes in law, regulations, or technology may result in an equivalent unit not being available. Other limitations and exclusions apply, refer to complete warranty details for full list of limitations and exclusions, as well as rights and obligations should an equivalent unit not be available.

† One-time Compressor Replacement coverage is available to the original homeowner for years 11-99 after the installation date through an ASURE Extend Service Plan. Complete details about the Extended Service Plan options available from your ASURE dealer.

NOMENCLATURE

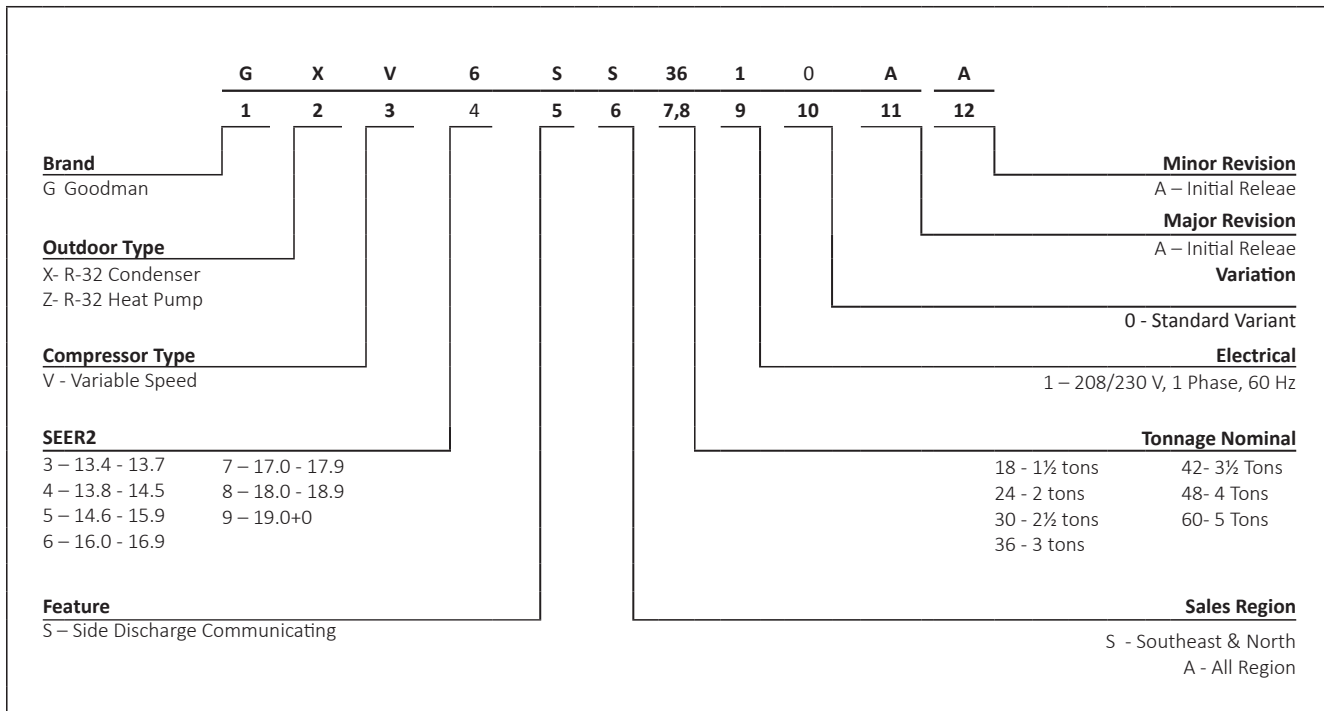

	GXV6SS 1810A*	GXV6SS 2410A*	GXV6SS 3010A*	GXV6SS 3610A*	GXV6SS 4210A*	GXV6SS 4810A*	GXV6SS 6010A*
CAPACITIES (AHRI RATED)							
Max. Cooling (BTU/h)	17,100	23,200	28,400	34,200	41,000	45,500	53,500
AMBIENT OPERATION RANGE COOLING (*FDB(*CDB))	0 to 115 (-17.8 to 46.1)						
COMPRESSOR							
Type	Swing	Swing	Swing	Swing	Swing	Swing	Swing
CONDENSER FAN MOTOR							
Horsepower	0.09	0.09	0.20	0.20	0.36	0.36	0.36
REFRIGERATION SYSTEM							
Refrigerant Line Size ¹							
Liquid Line Size ("O.D.)	3/8"	3/8"	3/8"	3/8"	3/8"	3/8"	3/8"
Suction Line Size ("O.D.)	3/4"	3/4"	7/8"	7/8"	1 1/8"	1 1/8"	1 1/8"
Refrigerant Connection Size							
Liquid Valve Size ("O.D.)	3/8"	3/8"	3/8"	3/8"	3/8"	3/8"	3/8"
Suction Valve Size ("O.D.)	3/4"	3/4"	7/8"	7/8"	7/8"	7/8"	7/8"
Valve Connection Type	Front Sealing	Front Sealing	Front Sealing	Front Sealing	Front and Back Sealing	Front and Back Sealing	Front and Back Sealing
Refrigerant Charge (oz.)	74	74	76	83	100	100	118
Expansion Device	EEV	EEV	EEV	EEV	EEV	EEV	EEV
Superheat at Service Valve	Auto-control	Auto-control	Auto-control	Auto-control	Auto-control	Auto-control	Auto-control
Subcooling at Service Valve	10±1°F	12±1°F	14±1°F	15±1°F	8±1°F	9±1°F	9±1°F
ELECTRICAL DATA							
Voltage / Phase (60 Hz)	208-230/1	208-230/1	208-230/1	208-230/1	208-230/1	208-230/1	208-230/1
Fan/Compressor Inverter Drive Input	8.1	13.3	17.6	17.6	25.4	25.4	30
Minimum Circuit Ampacity ²	12.8	16.8	22.4	22.4	31.8	31.8	37.5
Max. Overcurrent Protection ³	15	20	25	25	35	35	40
Min / Max Volts	197/253	197/253	197/253	197/253	197/253	197/253	197/253
Electrical Conduit Size	1/2"	1/2"	1/2"	1/2"	1/2" or 3/4"	1/2" or 3/4"	1/2" or 3/4"
EQUIPMENT WEIGHT (LBS)	119	119	129	133	163	163	174
SHIP WEIGHT (LBS)	133	133	143	148	183	183	196

¹ Tested and rated in accordance with ANSI/AHRI Standard 210/240

² Wire size should be determined in accordance with National Electrical Codes; extensive wire runs will require larger wire sizes

³ Must use time-delay fuses or HACR-type circuit breakers of the same size as noted.

NOTES

- Always check the S&R plate for electrical data on the unit being installed.
- Installer will need to supply 3/8" to 1 1/8" adapters for suction line connections.
- Unit is charged with refrigerant for 15' of 3/8" liquid line. System charge must be adjusted per Installation Instructions Final Charge Procedure. (See table below for allowable line set diameter)

UNIT TONS	ALLOWABLE LINE SET DIAMETER						
	LIQUID			SUCTION			
	1/4"	5/16"	3/8"	3/8"	1/2"	5/8"	1 1/8"
1.5	X	X	X	X*	X		
2.0		X	X	X*	X		
2.5		X	X	X*	X		
3.0		X	X		X*	X	
3.5			X			X	X
4.0			X			X	X
5.0			X			X	X

* Allowable combination

* For marked combinations, if normal ambient operation temperature is less than 14°F, limit line set length to 50 ft. max.

OUTDOOR UNIT	GXV6S*361*A*	
INDOOR UNIT	G*VT960403B/0603B G*VM970603B G*VT800603B/0803B MBVK12BP G*VS960603BU	TRIM MORE THAN 10% SETTINGS ARE INVALID. TRIMMED UP CFM MAKES MISS MATCHING ERROR.
OUTDOOR UNIT	GXV6S*601*A*	
INDOOR UNIT	G*VT960804C G*VM970804C G*VT800804C	TRIM MORE THAN 5% SETTINGS ARE INVALID. TRIMMED UP CFM MAKES MISS MATCHING ERROR.

PRODUCT SPECIFICATIONS

	GXV6SA 1810A*	GXV6SA 2410A*	GXV6SA 3010A*	GXV6SA 3610A*
CAPACITIES (AHRI RATED)				
Max. Cooling (BTU/h)	17,100	23,200	28,400	33,000
AMBIENT OPERATION RANGE COOLING (°FDB(°CDB))	0 to 115 (-17.8 to 46.1)			
COMPRESSOR				
Type	Swing	Swing	Swing	Swing
CONDENSER FAN MOTOR				
Horsepower	0.09	0.09	0.20	0.20
REFRIGERATION SYSTEM				
Refrigerant Line Size ¹				
Liquid Line Size ("O.D.)	3/8"	3/8"	3/8"	3/8"
Suction Line Size ("O.D.)	3/4"	3/4"	7/8"	7/8"
Refrigerant Connection Size				
Liquid Valve Size ("O.D.)	3/8"	3/8"	3/8"	3/8"
Suction Valve Size ("O.D.)	3/4"	3/4"	7/8"	7/8"
Valve Connection Type	Front Sealing	Front Sealing	Front Sealing	Front Sealing
Refrigerant Charge (oz.)	74	74	76	83
Expansion Device	EEV	EEV	EEV	EEV
Superheat at Service Valve	Auto-control	Auto-control	Auto-control	Auto-control
Subcooling at Service Valve	10±1°F	12±1°F	14±1°F	13±1°F
ELECTRICAL DATA				
Voltage / Phase (60 Hz)	208-230/1	208-230/1	208-230/1	208-230/1
Fan/Compressor Inverter Drive Input	8.1	13.3	17.6	17.6
Minimum Circuit Ampacity ²	12.8	16.8	22.4	22.4
Max. Overcurrent Protection ³	15	20	25	25
Min / Max Volts	197/253	197/253	197/253	197/253
Electrical Conduit Size	1/2"	1/2"	1/2"	1/2"
EQUIPMENT WEIGHT (LBS)	119	119	129	133
SHIP WEIGHT (LBS)	133	133	143	148

¹ Tested and rated in accordance with ANSI/AHRI Standard 210/240

² Wire size should be determined in accordance with National Electrical Codes; extensive wire runs will require larger wire sizes

³ Must use time-delay fuses or HACR-type circuit breakers of the same size as noted.

NOTES

- Always check the S&R plate for electrical data on the unit being installed.
- Installer will need to supply 3/8" to 1 1/2" adapters for suction line connections.
- Unit is charged with refrigerant for 15' of 3/8" liquid line. System charge must be adjusted per Installation Instructions Final Charge Procedure.

EXPANDED COOLING DATA — GXV6SS1810A* / AHVE24BP1300A*

IDB	AIRFLOW	OUTDOOR AMBIENT TEMPERATURE												105°F												115°F											
		65°F				75°F				85°F				95°F				105°F				115°F															
		59	63	67	71	59	63	67	71	59	63	67	71	59	63	67	71	59	63	67	71	59	63	67	71												
70	MBh	17.8	18.6	19.1	17.8	18.1	18.6	17.0	17.2	17.8	15.8	16.1	16.6	14.6	14.8	15.3	13.4	13.7	14.2	14.6	14.8	15.3	13.4	13.7	14.2	14.6	14.8	15.3	13.4	13.7	14.2						
	S/T	0.62	0.52	0.38	0.60	0.52	0.38	0.62	0.54	0.41	0.63	0.56	0.42	0.65	0.58	0.44	0.70	0.63	0.49	0.65	0.58	0.44	0.70	0.63	0.49	0.65	0.58	0.44	0.70	0.63	0.49						
	ΔT	22	18	14	19	17	14	19	17	14	18	16	13	17	16	13	18	16	14	17	16	13	18	16	14	17	16	13	18	16	14						
	kW	0.85	0.93	0.93	1.08	1.07	1.07	1.24	1.24	1.24	1.24	1.43	1.43	1.64	1.64	1.64	1.89	1.89	1.89	1.64	1.64	1.64	1.89	1.89	1.89	1.64	1.64	1.64	1.89	1.89	1.89						
	Amps	3.6	3.9	3.9	4.4	4.4	4.4	4.4	4.9	4.9	4.9	5.6	5.6	6.5	6.5	6.5	7.7	7.7	7.7	6.5	6.5	6.5	7.7	7.7	7.7	6.5	6.5	6.5	7.7	7.7	7.7						
	Hi PR	234	237	238	277	278	279	321	322	323	321	322	323	421	423	424	479	480	482	421	423	424	479	480	482	421	423	424	479	480	482						
	Lo PR	121	122	129	125	128	135	130	133	141	130	133	141	137	141	148	142	146	153	137	141	148	142	146	153	137	141	148	142	146	153						
	MBh	18.6	18.9	19.4	18.1	18.3	18.9	17.2	17.5	18.0	16.1	16.4	16.9	14.8	15.1	15.6	13.7	13.9	14.4	14.8	15.1	15.6	13.7	13.9	14.4	14.8	15.1	15.6	13.7	13.9	14.4						
	S/T	0.67	0.59	0.46	0.67	0.59	0.46	0.69	0.62	0.48	0.71	0.63	0.50	0.73	0.65	0.52	0.99	0.70	0.57	0.73	0.65	0.52	0.99	0.70	0.57	0.73	0.65	0.52	0.99	0.70	0.57						
	ΔT	18	16	13	18	16	13	18	16	13	17	15	12	16	15	12	17	15	12	16	15	12	17	15	12	16	15	12	17	15	12						
kW	0.94	0.94	0.94	1.08	1.08	1.08	1.25	1.25	1.25	1.44	1.44	1.44	1.66	1.65	1.65	1.90	1.90	1.90	1.65	1.65	1.65	1.90	1.90	1.90	1.65	1.65	1.65	1.90	1.90	1.90							
Amps	3.9	3.9	3.9	4.4	4.4	4.4	5.0	5.0	5.0	5.7	5.7	5.7	6.6	6.5	6.5	7.7	7.7	7.7	6.6	6.5	6.5	7.7	7.7	7.7	6.6	6.5	6.5	7.7	7.7	7.7							
Hi PR	238	239	241	279	280	282	323	324	326	371	372	374	424	425	427	481	482	484	424	425	427	481	482	484	424	425	427	481	482	484							
Lo PR	121	124	131	127	130	138	132	135	143	136	139	147	139	143	151	144	148	156	139	143	151	144	148	156	139	143	151	144	148	156							
MBh	19.0	19.2	19.8	18.4	18.7	19.2	17.6	17.8	18.4	16.4	16.7	17.2	15.2	15.4	15.9	14.0	14.2	14.7	15.2	15.4	15.9	14.0	14.2	14.7	15.2	15.4	15.9	14.0	14.2	14.7							
S/T	0.71	0.63	0.49	0.71	0.63	0.50	0.73	0.65	0.52	0.75	0.67	0.54	0.76	0.69	0.56	0.99	0.74	0.60	0.76	0.69	0.56	0.99	0.74	0.60	0.76	0.69	0.56	0.99	0.74	0.60							
ΔT	17	15	12	17	15	12	17	15	12	16	14	11	15	14	11	16	14	11	15	14	11	16	14	11	15	14	11	16	14	11							
kW	0.94	0.94	0.94	1.09	1.09	1.09	1.26	1.26	1.25	1.44	1.44	1.44	1.66	1.65	1.65	1.91	1.91	1.91	1.66	1.65	1.65	1.91	1.91	1.91	1.66	1.65	1.65	1.91	1.91	1.91							
Amps	4.0	3.9	3.9	4.4	4.4	4.4	5.0	5.0	5.0	5.7	5.7	5.7	6.6	6.6	6.6	7.8	7.8	7.8	6.6	6.6	6.6	7.8	7.8	7.8	6.6	6.6	6.6	7.8	7.8	7.8							
Hi PR	240	241	243	281	283	284	325	327	328	374	375	376	426	428	429	484	485	487	426	428	429	484	485	487	426	428	429	484	485	487							
Lo PR	123	127	134	129	133	140	134	138	145	138	142	149	142	145	153	146	150	158	142	145	153	146	150	158	142	145	153	146	150	158							

75	MBh	17.8	18.6	19.1	20.0	17.8	18.1	18.6	19.4	17.0	17.2	17.8	18.6	15.9	16.1	16.6	17.4	14.6	14.8	15.3	13.4	13.7	14.2	14.9	
	S/T	0.76	0.64	0.51	0.37	0.72	0.65	0.51	0.37	0.75	0.67	0.54	0.39	1.00	0.69	0.55	0.41	1.00	0.70	0.57	0.43	0.99	0.75	0.62	0.48
	ΔT	26	22	18	15	23	21	18	14	23	21	18	14	22	20	17	14	21	19	16	13	22	20	17	14
	kW	0.85	0.93	0.93	0.93	1.07	1.07	1.07	1.08	1.24	1.24	1.24	1.25	1.43	1.43	1.42	1.43	1.64	1.64	1.64	1.65	1.89	1.89	1.89	1.90
	Amps	3.6	3.9	3.9	3.9	4.4	4.4	4.4	4.4	4.9	4.9	4.9	5.0	5.6	5.6	5.6	5.7	6.5	6.5	6.5	6.5	7.7	7.7	7.7	7.7
	Hi PR	234	237	238	243	277	278	280	284	321	322	324	328	369	370	372	376	422	423	424	429	479	480	482	486
	Lo PR	121	122	129	141	125	128	135	147	130	133	141	153	134	137	145	157	137	141	148	161	142	146	154	166
	MBh	18.6	18.9	19.4	20.3	18.1	18.3	18.9	19.7	17.3	17.5	18.0	18.8	16.1	16.4	16.9	17.7	14.9	15.1	15.6	16.4	13.7	13.9	14.4	15.2
	S/T	0.80	0.72	0.58	0.44	0.80	0.72	0.59	0.45	0.82	0.75	0.61	0.47	1.00	0.76	0.63	0.49	1.00	0.78	0.65	0.50	0.99	0.83	0.69	0.55
	ΔT	22	20	17	14	22	20	17	13	21	20	16	13	21	19	16	13	20	18	15	12	20	19	16	13
kW	0.94	0.93	0.93	0.94	1.08	1.08	1.08	1.09	1.25	1.25	1.25	1.26	1.44	1.43	1.43	1.44	1.65	1.65	1.65	1.66	1.90	1.90	1.90	1.91	
Amps	3.9	3.9	3.9	3.9	4.4	4.4	4.4	4.4	5.0	5.0	5.0	5.0	5.7	5.7	5.7	5.7	6.6	6.5	6.5	6.6	7.7	7.7	7.7	7.8	
Hi PR	238	239	241	245	279	280	282	286	323	324	326	330	371	372	374	379	424	425	427	431	482	483	484	489	
Lo PR	121	124	131	143	127	130	138	150	132	135	143	155	136	139	147	159	139	143	151	163	144	148	156	168	
MBh	19.0	19.2	19.8	20.6	18.4	18.7	19.2	20.0	17.6	17.8	18.4	19.2	16.5	16.7	17.2	18.0	15.2	15.4	15.9	16.7	14.0	14.3	14.8	15.5	
S/T	0.83	0.76	0.62	0.48	0.84	0.76	0.63	0.48	1.01	0.78	0.65	0.51	1.00	0.80	0.66	0.52	1.00	0.82	0.68	0.54	0.99	0.86	0.73	0.59	
ΔT	21	19	16	12	20	19	15	12	20	19	15	12	20	18	15	12	19	17	14	11	19	18	15	12	
kW	0.94	0.94	0.94	0.95	1.09	1.09	1.09	1.09	1.26	1.25	1.25	1.26	1.44	1.44	1.44	1.45	1.66	1.65	1.65	1.66	1.91	1.91	1.90	1.91	
Amps	3.9	3.9	3.9	4.0	4.4	4.4	4.4	4.4	5.0	5.0	5.0	5.0	5.7	5.7	5.7	5.7	6.6	6.6	6.6	6.6	7.8	7.8	7.8	7.8	
Hi PR	241	242	243	247	282	283	284	289	326	327	328	333	374	375	377	381	427	428	430	434	484	485	487	491	
Lo PR	123	127	134	146	129	133	140	152	134	138	145	157	138	142	149	161	142	145	153	165	147	150	158	171	

IDB = Entering Indoor Dry Bulb Temperature
 High and low pressures are measured at the liquid and suction service valves.
 Airflow may vary depending on actual ambient conditions and system operation modes.
 Shaded area is ACCA (TVA) conditions.
 kW = Total system power
 Amps = outdoor unit amps (comp.+fan)

EXPANDED COOLING DATA — GXV6SS1810A* / AHVE24BP1300A* (CONT.)

IDB	AIRFLOW	OUTDOOR AMBIENT TEMPERATURE												ENTERING INDOOR WET BULB TEMPERATURE											
		65°F				75°F				85°F				95°F				105°F				115°F			
		59	63	67	71	59	63	67	71	59	63	67	71	59	63	67	71	59	63	67	71	59	63	67	71
80	MBh	18.4	18.7	19.2	20.1	17.9	18.2	18.7	19.5	17.1	17.3	17.9	18.7	15.9	16.2	16.7	17.5	14.7	14.9	15.4	16.2	13.5	13.8	14.3	15.0
	S/T	0.85	0.77	0.63	0.49	1.01	0.77	0.64	0.50	1.01	0.79	0.66	0.52	1.00	0.81	0.68	0.53	1.00	0.83	0.69	0.55	0.99	0.99	0.74	0.60
	ΔT	27	26	22	19	27	25	22	18	26	25	21	18	25	24	21	17	25	23	20	17	25	23	21	17
	kW	0.93	0.93	0.93	0.93	1.07	1.07	1.07	1.08	1.24	1.24	1.24	1.25	1.43	1.43	1.43	1.43	1.64	1.64	1.64	1.65	1.89	1.89	1.89	1.90
	Amps	3.9	3.9	3.9	3.9	4.4	4.4	4.4	4.4	5.0	4.9	4.9	5.0	5.6	5.6	5.6	5.6	6.5	6.5	6.5	6.5	7.7	7.7	7.7	7.7
	Hi PR	236	237	239	243	277	278	280	284	321	322	324	328	369	370	372	376	422	423	425	429	479	480	482	487
Lo PR	119	123	130	141	125	129	136	148	130	134	141	153	134	138	145	157	138	141	149	161	143	146	154	166	
80	MBh	18.7	19.0	19.5	20.4	18.2	18.4	19.0	19.8	17.3	17.6	18.1	18.9	16.2	16.5	17.1	17.8	14.9	15.2	15.7	16.5	13.8	14.0	14.5	15.3
	S/T	0.92	0.85	0.71	0.57	1.01	0.85	0.71	0.57	1.01	0.87	0.73	0.59	1.00	0.88	0.75	0.61	1.00	0.90	0.77	0.63	0.99	0.99	0.82	0.68
	ΔT	26	24	21	17	25	24	20	17	25	23	20	17	24	23	20	16	23	22	19	16	24	22	19	16
	kW	0.94	0.94	0.93	0.94	1.08	1.08	1.08	1.09	1.25	1.25	1.25	1.26	1.44	1.44	1.44	1.44	1.65	1.65	1.65	1.66	1.90	1.90	1.90	1.91
	Amps	3.9	3.9	3.9	4.0	4.4	4.4	4.4	4.4	5.0	5.0	5.0	5.0	5.7	5.7	5.7	5.7	6.6	6.5	6.5	6.6	7.7	7.7	7.7	7.8
	Hi PR	239	240	241	245	280	281	282	287	324	325	326	331	372	373	375	379	425	426	428	432	482	483	485	489
Lo PR	121	125	132	144	127	131	138	150	132	136	143	155	136	140	150	160	140	144	151	163	145	148	156	169	
700	MBh	19.1	19.3	19.9	20.7	18.5	18.8	19.3	20.1	17.7	17.9	18.5	19.3	16.5	16.8	17.3	18.1	15.3	15.5	16.0	16.8	14.1	14.3	14.8	15.6
	S/T	1.01	0.88	0.75	0.61	1.01	0.89	0.75	0.61	1.01	0.91	0.77	0.63	1.00	0.92	0.79	0.65	1.00	1.00	0.81	0.67	0.99	0.99	0.85	0.71
	ΔT	25	23	20	16	24	23	19	16	24	22	19	16	23	22	18	15	22	21	18	15	23	21	18	15
	kW	0.94	0.94	0.94	0.95	1.09	1.09	1.09	1.10	1.26	1.26	1.26	1.26	1.44	1.44	1.44	1.45	1.66	1.65	1.65	1.66	1.91	1.91	1.91	1.92
	Amps	4.0	3.9	3.9	4.0	4.4	4.4	4.4	4.4	5.0	5.0	5.0	5.0	5.7	5.7	5.7	5.7	6.6	6.6	6.6	6.6	7.8	7.8	7.8	7.8
	Hi PR	241	242	244	248	282	283	285	289	326	327	329	333	374	375	377	381	427	428	430	434	484	486	487	492
Lo PR	124	127	134	146	130	133	141	153	135	138	146	158	139	142	150	162	142	146	153	166	147	151	158	171	

85	MBh	18.7	19.0	19.5	20.4	18.2	18.5	19.0	19.8	17.4	17.6	18.1	19.0	16.2	16.5	17.0	17.8	15.0	15.2	15.7	16.5	13.8	14.0	14.5	15.3
	S/T	1.01	0.87	0.74	0.59	1.01	0.87	0.74	0.60	1.01	1.01	0.76	0.62	1.00	1.00	0.78	0.63	1.00	1.00	0.79	0.65	0.99	0.99	0.84	0.70
	ΔT	31	29	26	22	30	28	25	22	30	28	25	21	29	27	24	21	28	26	23	20	28	27	24	21
	kW	0.93	0.93	0.93	0.94	1.08	1.08	1.07	1.08	1.24	1.24	1.24	1.25	1.43	1.43	1.43	1.44	1.64	1.64	1.64	1.65	1.90	1.89	1.89	1.90
	Amps	3.9	3.9	3.9	3.9	4.4	4.4	4.4	4.4	5.0	5.0	4.9	5.0	5.6	5.6	5.6	5.7	6.5	6.5	6.5	6.6	7.7	7.7	7.7	7.7
	Hi PR	237	238	240	244	278	279	281	285	322	323	325	329	371	372	373	378	423	424	426	430	481	482	483	488
Lo PR	121	125	132	143	127	131	138	150	132	136	143	155	136	140	147	159	140	143	151	163	144	148	156	168	
85	MBh	19.0	19.3	19.8	20.7	18.5	18.7	19.3	20.1	17.6	17.9	18.4	19.2	16.5	16.7	17.3	18.1	15.2	15.5	16.0	16.7	14.1	14.3	14.8	15.5
	S/T	1.01	0.95	0.81	0.67	1.01	0.95	0.81	0.67	1.01	1.01	0.84	0.69	1.00	1.00	0.85	0.71	1.00	1.00	0.87	0.73	0.99	0.99	0.92	0.78
	ΔT	29	28	24	21	29	27	24	20	28	27	23	20	27	26	23	20	27	25	22	19	27	25	22	19
	kW	0.94	0.94	0.94	0.94	1.08	1.08	1.08	1.09	1.25	1.25	1.25	1.26	1.44	1.44	1.44	1.45	1.65	1.65	1.65	1.66	1.90	1.90	1.90	1.91
	Amps	3.9	3.9	3.9	4.0	4.4	4.4	4.4	4.4	5.0	5.0	5.0	5.0	5.7	5.7	5.7	5.7	6.6	6.6	6.5	6.6	7.8	7.8	7.7	7.8
	Hi PR	240	241	242	247	281	282	284	288	325	326	328	332	373	374	376	380	426	427	429	433	483	484	486	490
Lo PR	123	127	134	146	129	133	140	152	134	138	145	157	138	142	149	161	142	145	153	165	146	150	158	171	
85	MBh	19.4	19.6	20.2	21.0	18.8	19.1	19.6	20.4	18.0	18.2	18.8	19.6	16.8	17.1	17.6	18.4	15.6	15.8	16.3	17.1	14.4	14.6	15.1	15.9
	S/T	1.01	0.99	0.85	0.71	1.01	0.99	0.85	0.71	1.01	1.01	0.87	0.73	1.00	1.00	0.89	0.75	1.00	1.00	0.91	0.77	0.99	0.99	0.99	0.81
	ΔT	28	27	23	20	28	26	23	19	27	26	22	19	26	25	22	19	26	24	21	18	26	24	21	18
	kW	0.94	0.94	0.94	0.95	1.09	1.09	1.09	1.10	1.26	1.26	1.26	1.27	1.45	1.44	1.44	1.45	1.66	1.66	1.66	1.66	1.91	1.91	1.91	1.92
	Amps	4.0	4.0	3.9	4.0	4.4	4.4	4.4	4.5	5.0	5.0	5.0	5.0	5.7	5.7	5.7	5.7	6.6	6.6	6.6	6.6	7.8	7.8	7.8	7.8
	Hi PR	242	243	245	249	283	284	286	290	327	328	330	334	375	377	378	383	428	429	431	435	486	487	489	493
Lo PR	126	129	136	148	132	135	142	155	136	140	148	160	140	144	152	164	144	148	155	168	149	152	160	173	

IDB = Entering Indoor Dry Bulb Temperature
 High and low pressures are measured at the liquid and suction service valves.
 Airflow may vary depending on actual ambient conditions and system operation modes.
 Shaded area is AHRI conditions.
 kW = Total system power
 Amps = outdoor unit amps (comp.+fan)

EXPANDED COOLING DATA — GXV6SS2410A* / AHVE24BP1300A*

IDB	AIRFLOW	OUTDOOR AMBIENT TEMPERATURE												105°F												115°F											
		65°F				75°F				85°F				95°F				105°F				115°F															
		59	63	67	71	59	63	67	71	59	63	67	71	59	63	67	71	59	63	67	71	59	63	67	71												
70	MBh	20.3	25.6	26.3	24.4	24.7	25.5	23.1	23.5	24.2	21.5	21.8	22.5	19.7	20.0	20.7	18.0	18.3	19.0	19.7	20.0	20.7	18.0	18.3	19.0	19.7	20.0	20.7	18.0	18.3	19.0						
	S/T	0.63	0.51	0.37	0.59	0.51	0.38	0.61	0.53	0.40	0.63	0.55	0.42	0.64	0.57	0.44	0.69	0.62	0.49	0.64	0.57	0.44	0.69	0.62	0.49	0.64	0.57	0.44	0.69	0.62	0.49						
	ΔT	22	19	15	20	18	15	20	18	15	19	17	14	18	16	13	19	17	14	18	16	13	19	17	14	18	16	13	19	17	14						
	kW	1.09	1.57	1.56	1.78	1.78	1.78	2.02	2.02	2.01	2.28	2.27	2.27	2.57	2.56	2.56	2.91	2.90	2.90	2.57	2.56	2.56	2.91	2.90	2.90	2.57	2.56	2.56	2.91	2.90	2.90						
	Amps	4.4	6.0	6.0	6.8	6.8	6.8	7.8	7.8	7.8	8.9	8.9	8.9	10.0	10.0	9.9	10.1	10.2	10.2	10.0	10.0	9.9	10.1	10.2	10.2	10.0	10.0	9.9	10.1	10.2	10.2						
	Hi PR	243	261	263	303	304	306	349	350	352	399	401	402	454	455	457	513	514	516	454	455	457	513	514	516	454	455	457	513	514	516						
	Lo PR	120	119	126	121	125	132	126	130	138	130	134	141	133	137	145	138	142	150	133	137	145	138	142	150	133	137	145	138	142	150						
800	MBh	23.2	26.0	26.7	24.8	25.1	25.8	23.5	23.8	24.6	21.8	22.2	22.9	20.0	20.3	21.0	18.3	18.7	19.3	20.0	20.3	21.0	18.3	18.7	19.3	20.0	20.3	21.0	18.3	18.7	19.3						
	S/T	0.69	0.58	0.45	0.66	0.59	0.45	0.68	0.61	0.48	0.70	0.62	0.49	0.72	0.64	0.51	0.76	0.69	0.56	0.72	0.64	0.51	0.76	0.69	0.56	0.72	0.64	0.51	0.76	0.69	0.56						
	ΔT	21	17	14	19	17	13	18	17	13	18	16	13	17	15	12	17	16	13	17	15	12	17	16	13	17	15	12	17	16	13						
	kW	1.28	1.58	1.58	1.79	1.79	1.79	2.03	2.03	2.03	2.29	2.29	2.28	2.58	2.58	2.57	2.92	2.92	2.91	2.58	2.58	2.57	2.92	2.92	2.91	2.58	2.58	2.57	2.92	2.92	2.91						
	Amps	5.0	6.0	6.0	6.9	6.9	6.8	7.9	7.9	7.9	9.0	9.0	9.0	10.0	10.0	10.0	10.1	10.1	10.1	10.0	10.0	10.0	10.1	10.1	10.1	10.0	10.0	10.0	10.1	10.1	10.1						
	Hi PR	251	263	265	306	307	309	352	353	355	402	403	405	457	458	460	516	517	519	457	458	460	516	517	519	457	458	460	516	517	519						
	Lo PR	120	121	129	123	127	135	128	132	140	131	136	144	135	139	147	140	144	152	135	139	147	140	144	152	135	139	147	140	144	152						
920	MBh	26.1	26.5	27.2	25.2	25.6	26.3	24.0	24.3	25.0	22.3	22.6	23.3	20.4	20.8	21.4	18.8	19.1	19.7	20.4	20.8	21.4	18.8	19.1	19.7	20.4	20.8	21.4	18.8	19.1	19.7						
	S/T	0.70	0.62	0.49	0.70	0.62	0.49	0.72	0.65	0.51	0.74	0.66	0.53	0.75	0.68	0.55	0.80	0.73	0.60	0.75	0.68	0.55	0.80	0.73	0.60	0.75	0.68	0.55	0.80	0.73	0.60						
	ΔT	18	16	13	17	16	12	17	15	12	16	15	12	16	14	11	16	15	12	16	14	11	16	15	12	16	14	11	16	15	12						
	kW	1.59	1.59	1.59	1.80	1.80	1.80	2.04	2.04	2.04	2.30	2.30	2.29	2.59	2.59	2.58	2.93	2.93	2.92	2.59	2.59	2.58	2.93	2.93	2.92	2.59	2.59	2.58	2.93	2.93	2.92						
	Amps	6.1	6.1	6.1	6.9	6.9	6.9	7.9	7.9	7.9	9.1	9.0	9.0	10.0	10.0	10.0	10.1	10.1	10.1	10.0	10.0	10.0	10.1	10.1	10.1	10.0	10.0	10.0	10.1	10.1	10.1						
	Hi PR	265	266	268	308	310	311	355	356	358	405	406	408	459	461	463	518	520	522	459	461	463	518	520	522	459	461	463	518	520	522						
	Lo PR	119	124	131	125	129	137	130	134	142	134	138	146	137	142	150	142	146	154	137	142	150	142	146	154	137	142	150	142	146	154						

75	MBh	20.3	25.6	26.3	24.4	24.7	25.5	26.6	23.5	24.2	25.3	21.5	21.8	22.5	23.6	19.7	20.0	20.7	18.0	18.3	19.0	20.0		
	S/T	0.77	0.64	0.50	0.71	0.64	0.51	0.36	0.74	0.66	0.53	0.39	0.75	0.68	0.54	0.41	0.77	0.70	0.56	0.42	0.47	0.47		
	ΔT	26	23	19	24	22	19	15	24	22	18	15	23	21	18	14	22	20	17	14	22	20	17	14
	kW	1.09	1.57	1.56	1.78	1.78	1.77	1.79	1.79	2.02	2.01	2.03	2.27	2.27	2.27	2.29	2.56	2.56	2.56	2.90	2.90	2.90	2.91	
	Amps	4.4	6.0	6.0	6.8	6.8	6.8	6.8	7.8	7.8	7.8	7.9	8.9	8.9	8.9	9.0	10.0	9.9	9.9	10.0	10.2	10.2	10.1	
	Hi PR	244	261	263	303	304	306	311	349	351	352	357	400	401	403	407	454	455	457	462	513	514	516	521
	Lo PR	120	119	126	121	125	133	144	126	130	138	149	130	134	142	153	133	138	145	157	138	142	150	162
800	MBh	23.2	26.0	26.7	24.8	25.1	25.9	27.0	23.5	23.9	24.6	25.7	21.9	22.2	22.9	24.0	20.0	20.3	21.0	22.1	18.4	18.7	19.3	20.3
	S/T	0.83	0.71	0.58	0.79	0.71	0.58	0.44	0.81	0.73	0.60	0.46	0.82	0.75	0.62	0.48	1.00	0.77	0.64	0.50	0.99	0.82	0.68	0.55
	ΔT	25	21	18	23	21	17	14	22	20	17	14	21	20	16	13	20	19	16	12	21	19	16	13
	kW	1.28	1.58	1.58	1.79	1.79	1.79	1.80	2.03	2.03	2.02	2.04	2.29	2.29	2.28	2.30	2.58	2.58	2.57	2.59	2.92	2.92	2.91	2.93
	Amps	5.0	6.0	6.0	6.9	6.8	6.8	6.9	7.9	7.9	7.9	7.9	9.0	9.0	9.0	9.0	10.0	10.0	10.0	10.0	10.1	10.1	10.1	10.1
	Hi PR	251	264	265	306	307	309	314	352	353	355	360	402	403	405	410	457	458	460	465	516	517	519	524
	Lo PR	120	121	129	123	127	135	146	128	132	140	151	132	136	144	155	135	140	147	159	140	144	144	152
920	MBh	26.1	26.5	27.2	25.2	25.6	26.3	27.5	24.0	24.3	25.0	26.1	22.3	22.6	23.3	24.4	20.5	20.8	21.5	22.5	18.8	19.1	19.8	20.8
	S/T	0.82	0.75	0.61	0.83	0.75	0.62	0.48	0.85	0.77	0.64	0.50	1.00	0.79	0.66	0.52	1.00	0.81	0.67	0.54	0.99	0.85	0.72	0.58
	ΔT	22	20	17	21	20	16	13	21	19	16	13	20	19	15	12	19	18	15	11	20	18	15	12
	kW	1.59	1.59	1.59	1.80	1.80	1.80	1.81	2.04	2.04	2.04	2.05	2.30	2.30	2.29	2.31	2.59	2.59	2.58	2.60	2.93	2.93	2.92	2.94
	Amps	6.1	6.1	6.1	6.9	6.9	6.9	7.0	7.9	7.9	7.9	8.0	9.0	9.0	9.0	9.1	10.0	10.0	10.0	10.1	10.1	10.1	10.1	10.1
	Hi PR	265	266	268	309	310	312	316	355	356	358	362	405	406	408	413	460	461	463	467	519	520	522	526
	Lo PR	119	124	131	125	129	137	149	130	134	142	154	134	138	146	158	137	142	150	162	142	147	154	167

IDB = Entering Indoor Dry Bulb Temperature
 High and low pressures are measured at the liquid and suction service valves.
 Airflow may vary depending on actual ambient conditions and system operation modes.

Shaded area is ACCA (TVA) conditions.
 kW = Total system power
 Amps = outdoor unit amps (comp.+fan)

EXPANDED COOLING DATA —GXV6SS2410A* / AHVE24BP1300A* (CONT.)

IDB	AIRFLOW	OUTDOOR AMBIENT TEMPERATURE												ENTERING INDOOR WET BULB TEMPERATURE											
		65°F				75°F				85°F				95°F				105°F				115°F			
		59	63	67	71	59	63	67	71	59	63	67	71	59	63	67	71	59	63	67	71	59	63	67	71
80	MBh	21.9	25.7	26.5	27.6	24.5	24.9	25.6	26.7	23.3	23.6	24.3	25.4	21.6	21.9	22.6	23.7	19.8	20.1	20.8	21.8	18.1	18.4	19.1	20.1
	S/T	0.89	0.76	0.63	0.48	0.84	0.76	0.63	0.49	1.01	0.78	0.65	0.51	1.00	0.80	0.67	0.53	1.00	0.82	0.69	0.55	0.99	0.86	0.73	0.59
	ΔT	31	27	23	20	28	26	23	19	27	26	22	19	26	25	21	18	25	24	21	17	26	24	21	18
	kW	1.19	1.57	1.56	1.58	1.78	1.78	1.78	1.79	2.02	2.02	2.01	2.03	2.28	2.27	2.27	2.29	2.56	2.56	2.56	2.58	2.90	2.90	2.90	2.92
	Amps	4.7	6.0	6.0	6.0	6.8	6.8	6.8	6.9	7.8	7.8	7.8	7.9	8.9	8.9	8.9	9.0	10.0	10.0	10.0	10.0	10.2	10.2	10.2	10.1
	Hi PR	247	261	263	268	304	305	307	311	350	351	353	358	400	401	403	408	455	456	458	462	514	515	517	522
Lo PR	120	120	127	138	121	126	133	144	126	131	138	150	130	134	142	154	134	138	146	158	138	143	151	163	
80	MBh	25.2	26.1	26.9	28.0	24.9	25.2	26.0	27.1	23.6	24.0	24.7	25.8	22.0	22.3	23.2	24.1	20.1	20.5	21.1	22.2	18.5	18.8	19.4	20.5
	S/T	0.95	0.83	0.70	0.56	1.01	0.84	0.70	0.56	1.01	0.86	0.72	0.58	1.00	0.87	0.74	0.60	1.00	0.89	0.76	0.62	0.99	0.94	0.81	0.67
	ΔT	30	25	22	18	27	25	21	18	26	24	21	18	25	23	20	17	24	23	19	16	25	23	20	17
	kW	1.42	1.58	1.58	1.59	1.79	1.79	1.79	1.80	2.03	2.03	2.03	2.04	2.29	2.29	2.27	2.30	2.58	2.58	2.57	2.59	2.92	2.92	2.91	2.93
	Amps	5.5	6.0	6.0	6.1	6.9	6.9	6.8	6.9	7.9	7.9	7.9	7.9	9.0	9.0	9.0	9.1	10.0	10.0	10.0	10.0	10.1	10.1	10.1	10.1
	Hi PR	255	264	266	270	306	308	309	314	353	354	356	360	403	404	407	411	458	459	461	465	517	518	520	524
Lo PR	119	122	129	140	123	128	135	147	128	133	140	152	132	136	146	156	136	140	148	160	140	145	153	165	
920	MBh	26.2	26.6	27.4	28.5	25.4	25.7	26.5	27.6	24.1	24.4	25.2	26.3	22.4	22.8	23.5	24.5	20.6	20.9	21.6	22.6	18.9	19.2	19.9	20.9
	S/T	0.95	0.87	0.74	0.60	1.01	0.87	0.74	0.60	1.01	0.89	0.76	0.62	1.00	0.91	0.78	0.64	1.00	0.93	0.80	0.66	0.99	0.99	0.84	0.70
	ΔT	26	24	21	17	25	24	20	17	25	23	20	17	24	22	19	16	23	22	18	15	24	22	19	16
	kW	1.59	1.59	1.59	1.60	1.80	1.80	1.80	1.81	2.04	2.04	2.04	2.05	2.30	2.30	2.29	2.31	2.59	2.59	2.58	2.60	2.93	2.93	2.92	2.94
	Amps	6.1	6.1	6.1	6.1	6.9	6.9	6.9	7.0	7.9	7.9	7.9	8.0	9.1	9.0	9.0	9.1	10.0	10.0	10.0	10.1	10.1	10.1	10.1	10.1
	Hi PR	266	267	269	273	309	310	312	317	355	356	358	363	405	407	408	413	460	461	463	468	519	520	522	527
Lo PR	120	124	131	143	126	130	138	149	130	135	143	154	134	139	146	158	138	142	150	162	142	147	155	167	

85	MBh	23.4	26.1	26.9	28.1	24.9	25.3	26.0	27.1	23.7	24.0	24.7	25.8	22.0	22.3	23.0	24.1	20.2	20.5	21.2	22.2	18.5	18.8	19.5	20.5
	S/T	1.01	0.86	0.73	0.58	1.01	0.86	0.73	0.59	1.01	0.88	0.75	0.61	1.00	1.00	0.77	0.63	1.00	1.00	0.78	0.65	0.99	0.99	0.83	0.69
	ΔT	35	31	27	23	31	30	26	23	31	29	26	22	30	28	25	22	29	27	24	21	29	27	24	21
	kW	1.27	1.57	1.57	1.58	1.78	1.78	1.78	1.79	2.02	2.02	2.02	2.03	2.28	2.28	2.27	2.29	2.57	2.57	2.56	2.58	2.91	2.91	2.90	2.92
	Amps	5.0	6.0	6.0	6.0	6.8	6.8	6.8	6.9	7.8	7.8	7.8	7.9	9.0	9.0	9.0	9.0	10.0	10.0	10.0	10.0	10.1	10.1	10.1	10.1
	Hi PR	250	263	265	269	305	306	308	313	351	352	354	359	401	402	404	409	456	457	459	464	515	516	518	523
Lo PR	120	121	129	140	123	127	135	146	128	132	140	152	132	136	144	156	135	140	148	159	140	144	152	164	
800	MBh	26.2	26.5	27.3	28.4	25.3	25.7	26.4	27.5	24.0	24.4	25.1	26.2	22.4	22.7	23.4	24.5	20.5	20.8	21.5	22.6	18.8	19.2	19.8	20.8
	S/T	1.01	0.93	0.80	0.66	1.01	0.94	0.80	0.66	1.01	0.96	0.82	0.68	1.00	1.00	0.84	0.70	1.00	1.00	0.86	0.72	0.99	0.99	0.90	0.77
	ΔT	31	29	26	22	30	28	25	21	30	28	25	21	29	27	24	20	27	26	23	19	28	26	23	20
	kW	1.59	1.58	1.58	1.60	1.80	1.80	1.79	1.81	2.03	2.03	2.03	2.05	2.29	2.29	2.29	2.30	2.58	2.58	2.58	2.59	2.92	2.92	2.92	2.93
	Amps	6.1	6.1	6.0	6.1	6.9	6.9	6.9	6.9	7.9	7.9	7.9	7.9	9.0	9.0	9.0	9.1	10.0	10.0	10.0	10.0	10.1	10.1	10.1	10.1
	Hi PR	264	265	267	272	308	309	311	315	354	355	357	361	404	405	407	412	459	460	462	467	518	519	521	526
Lo PR	119	124	131	142	125	129	137	149	130	134	142	154	134	138	146	158	137	142	150	162	142	146	154	167	
920	MBh	26.7	27.0	27.8	28.9	25.8	26.1	26.9	28.0	24.5	24.8	25.6	26.7	22.8	23.2	23.9	24.9	21.0	21.3	22.0	23.0	19.3	19.6	20.3	21.3
	S/T	1.01	0.97	0.84	0.70	1.01	0.97	0.84	0.70	1.01	1.01	0.86	0.72	1.00	1.00	0.88	0.74	1.00	1.00	0.89	0.76	0.99	0.99	0.94	0.80
	ΔT	30	28	25	21	29	27	24	20	29	27	23	20	27	26	23	19	26	25	22	18	27	25	22	19
	kW	1.60	1.59	1.59	1.61	1.81	1.81	1.80	1.82	2.05	2.04	2.04	2.06	2.30	2.30	2.30	2.31	2.59	2.59	2.59	2.60	2.93	2.93	2.93	2.94
	Amps	6.1	6.1	6.1	6.1	6.9	6.9	6.9	7.0	7.9	7.9	7.9	8.0	9.1	9.1	9.0	9.1	10.0	10.0	10.0	10.1	10.1	10.1	10.1	10.1
	Hi PR	267	268	270	274	310	311	313	318	356	358	359	364	407	408	410	414	461	463	464	469	520	522	524	528
Lo PR	122	126	133	145	127	132	139	151	132	137	144	156	136	140	148	160	139	144	152	164	144	149	157	169	

IDB = Entering Indoor Dry Bulb Temperature
 High and low pressures are measured at the liquid and suction service valves.
 Airflow may vary depending on actual ambient conditions and system operation modes.
 Shaded area is AHRI conditions.
 kW = Total system power
 Amps = outdoor unit amps (comp.+fan)

EXPANDED COOLING DATA — GXV6SS3010A* / AHVE36CP1300A*

IDB	AIRFLOW	OUTDOOR AMBIENT TEMPERATURE												ENTERING INDOOR WET BULB TEMPERATURE											
		65°F				75°F				85°F				95°F				105°F				115°F			
		59	63	67	71	59	63	67	71	59	63	67	71	59	63	67	71	59	63	67	71	59	63	67	71
70	MBh	31.0	31.3	32.2	32.2	29.8	30.3	31.2	31.2	28.3	28.7	29.6	29.6	26.3	26.7	27.5	27.5	24.0	24.4	25.3	25.3	22.0	22.4	23.2	23.2
	S/T	0.60	0.52	0.38	0.39	0.60	0.52	0.39	0.41	0.63	0.55	0.41	0.41	0.65	0.57	0.44	0.44	0.68	0.60	0.46	0.46	0.73	0.66	0.52	0.52
	ΔT	22	18	15	14	20	18	14	14	19	17	14	14	19	17	14	14	18	16	13	13	18	17	14	14
	kW	1.82	2.03	2.02	2.02	2.27	2.27	2.27	2.27	2.54	2.54	2.54	2.54	2.83	2.83	2.83	2.83	3.15	3.15	3.15	3.15	3.53	3.52	3.52	3.52
	Amps	6.7	7.6	7.5	7.5	8.6	8.6	8.6	8.6	9.8	9.8	9.8	9.8	11.0	11.0	11.0	11.0	12.4	12.4	12.4	12.4	13.9	13.9	13.9	13.9
	Hi PR	274	275	277	277	317	318	320	320	362	364	365	365	411	412	414	414	464	465	467	467	520	521	523	523
	Lo PR	119	120	126	126	123	126	133	133	127	131	138	138	131	135	142	142	135	138	145	145	140	143	150	150
	MBh	31.5	31.8	32.7	32.7	30.3	30.7	31.6	31.6	28.8	29.2	30.1	30.1	26.7	27.1	28.0	28.0	24.5	24.9	25.7	25.7	22.4	22.8	23.6	23.6
	S/T	0.68	0.59	0.46	0.46	0.68	0.60	0.46	0.46	0.71	0.63	0.49	0.49	0.73	0.65	0.51	0.51	0.76	0.68	0.54	0.54	0.81	0.73	0.59	0.59
	ΔT	21	17	13	13	18	16	13	13	18	16	13	13	17	16	12	12	17	15	12	12	17	16	13	13
	kW	1.84	2.04	2.04	2.04	2.29	2.29	2.28	2.28	2.56	2.56	2.55	2.55	2.85	2.85	2.84	2.84	3.17	3.17	3.16	3.16	3.54	3.54	3.54	3.54
	Amps	6.8	7.6	7.6	7.6	8.7	8.7	8.7	8.7	9.9	9.9	9.8	9.8	11.1	11.1	11.1	11.1	12.5	12.4	12.4	12.4	14.0	14.0	14.0	14.0
Hi PR	277	278	280	280	320	321	323	323	365	366	368	368	414	415	417	417	467	468	470	470	523	524	526	526	
Lo PR	121	122	129	129	125	128	135	135	129	133	140	140	133	137	144	144	137	140	147	147	142	145	152	152	
MBh	32.0	32.4	33.3	33.3	30.9	31.3	32.2	32.2	29.3	29.7	30.6	30.6	27.3	27.7	28.5	28.5	25.0	25.4	26.2	26.2	23.0	23.3	24.2	24.2	
S/T	0.71	0.63	0.49	0.49	0.72	0.64	0.50	0.50	0.74	0.67	0.53	0.53	0.77	0.69	0.55	0.55	0.79	0.72	0.58	0.58	1.01	0.77	0.63	0.63	
ΔT	18	16	12	12	17	15	12	12	17	15	12	12	16	15	11	11	16	14	11	11	16	15	12	12	
kW	2.06	2.06	2.05	2.05	2.30	2.30	2.30	2.30	2.57	2.57	2.57	2.57	2.86	2.86	2.86	2.86	3.18	3.18	3.18	3.18	3.55	3.55	3.55	3.55	
Amps	7.7	7.7	7.7	7.7	8.8	8.7	8.7	8.7	9.9	9.9	9.9	9.9	11.2	11.1	11.1	11.1	12.5	12.5	12.5	12.5	14.1	14.1	14.0	14.0	
Hi PR	279	280	282	282	323	324	326	326	368	369	371	371	417	418	420	420	469	471	472	472	526	527	529	529	
Lo PR	121	124	131	131	127	130	137	137	132	135	142	142	136	139	146	146	139	143	150	150	144	147	155	155	
75	MBh	31.0	31.3	32.3	32.3	29.9	30.3	31.2	31.2	28.3	28.7	29.6	29.6	26.3	26.7	27.6	27.6	24.1	24.5	25.3	25.3	22.0	22.4	23.2	23.2
	S/T	0.73	0.64	0.51	0.37	0.73	0.65	0.52	0.37	0.76	0.68	0.55	0.40	0.78	0.71	0.57	0.42	1.01	0.73	0.59	0.45	1.01	0.79	0.65	0.50
	ΔT	27	22	19	15	24	22	18	15	23	21	18	15	22	21	17	14	21	20	17	14	22	20	17	14
	kW	1.82	2.03	2.02	2.04	2.27	2.27	2.27	2.29	2.54	2.54	2.54	2.56	2.83	2.83	2.83	2.84	3.15	3.15	3.14	3.14	3.52	3.52	3.52	3.54
	Amps	6.7	7.5	7.5	7.6	8.6	8.6	8.6	8.7	9.8	9.8	9.8	9.8	11.0	11.0	11.0	11.1	12.4	12.4	12.4	12.4	13.9	13.9	13.9	14.0
	Hi PR	274	275	277	282	317	318	320	325	363	364	366	370	411	413	415	419	464	465	467	472	520	521	523	528
	Lo PR	119	120	127	138	123	126	133	144	127	131	138	149	131	135	142	153	135	138	145	157	140	143	150	162
	MBh	31.5	31.8	32.7	34.2	30.3	30.8	31.7	33.0	28.8	29.2	30.1	31.4	26.7	27.1	28.0	29.3	24.5	24.9	25.7	27.0	22.5	22.8	23.6	24.9
	S/T	0.81	0.72	0.58	0.44	0.81	0.73	0.59	0.45	0.84	0.76	0.62	0.48	1.00	0.78	0.64	0.50	1.01	0.81	0.67	0.52	1.01	0.87	0.73	0.58
	ΔT	25	21	18	14	22	20	17	14	22	20	17	13	21	19	16	13	20	19	15	12	21	19	16	13
	kW	1.84	2.04	2.04	2.06	2.29	2.29	2.28	2.30	2.56	2.56	2.55	2.57	2.85	2.85	2.84	2.86	3.17	3.17	3.16	3.18	3.54	3.54	3.53	3.55
	Amps	6.8	7.6	7.6	7.7	8.7	8.7	8.7	8.7	9.9	9.8	9.8	9.9	11.1	11.1	11.1	11.1	12.4	12.4	12.4	12.5	14.0	14.0	14.0	14.1
Hi PR	277	278	280	285	320	321	323	328	365	367	368	373	414	415	417	422	467	468	470	475	523	524	526	531	
Lo PR	121	122	129	140	125	128	135	146	130	133	140	151	133	137	144	155	137	140	147	159	142	145	152	164	
MBh	32.0	32.4	33.3	34.8	30.9	31.3	32.2	33.6	29.4	29.8	30.6	32.0	27.3	27.7	28.6	29.9	25.0	25.4	26.3	27.5	23.0	23.4	24.2	25.4	
S/T	0.83	0.76	0.62	0.48	0.85	0.77	0.63	0.49	0.87	0.80	0.66	0.52	1.00	0.82	0.68	0.54	1.01	0.85	0.71	0.56	1.01	0.90	0.77	0.62	
ΔT	22	20	16	13	21	19	16	12	21	19	16	12	20	18	15	12	19	18	14	11	20	18	15	12	
kW	2.06	2.06	2.05	2.07	2.30	2.30	2.30	2.32	2.57	2.57	2.57	2.59	2.86	2.86	2.85	2.87	3.18	3.18	3.17	3.19	3.55	3.55	3.55	3.57	
Amps	7.7	7.7	7.7	7.7	8.7	8.7	8.7	8.8	9.9	9.9	9.9	10.0	11.1	11.1	11.1	11.2	12.5	12.5	12.5	12.6	14.1	14.0	14.0	14.1	
Hi PR	279	281	283	287	323	324	326	331	368	369	371	376	417	418	420	425	470	471	473	477	526	527	529	534	
Lo PR	121	124	131	142	127	130	137	149	132	135	142	154	136	139	146	158	139	143	150	162	144	147	155	167	

IDB = Entering Indoor Dry Bulb Temperature
 High and low pressures are measured at the liquid and suction service valves.
 Airflow may vary depending on actual ambient conditions and system operation modes.
 Shaded area is ACCA (TVA) conditions.
 kW = Total system power
 Amps = outdoor unit amps (comp. + fan)

EXPANDED COOLING DATA — GXV6SS3010A* / AHVE36CP1300A* (CONT.)

IDB	AIRFLOW	OUTDOOR AMBIENT TEMPERATURE												ENTERING INDOOR WET BULB TEMPERATURE												
		65°F				75°F				85°F				95°F				105°F				115°F				
		59	63	67	71	59	63	67	71	59	63	67	71	59	63	67	71	59	63	67	71	59	63	67	71	
80	MBh	31.2	31.5	32.4	33.8	30.0	30.4	31.3	32.7	28.5	28.9	29.8	31.1	26.4	26.9	27.7	29.0	24.2	24.6	25.4	26.7	22.2	22.6	23.4	24.6	
	S/T	0.86	0.77	0.63	0.49	0.99	0.78	0.64	0.50	1.00	0.81	0.67	0.53	1.00	0.83	0.70	0.55	1.01	0.86	0.72	0.58	1.01	0.92	0.78	0.63	
	ΔT	31	26	23	19	27	26	22	19	27	25	22	19	26	24	21	18	25	23	20	17	25	24	21	18	
	kW	1.82	2.03	2.02	2.04	2.27	2.27	2.27	2.29	2.54	2.54	2.54	2.56	2.83	2.83	2.83	2.85	3.15	3.15	3.15	3.17	3.53	3.52	3.52	3.54	
	Amps	6.7	7.6	7.5	7.6	8.6	8.6	8.6	8.7	9.8	9.8	9.8	9.8	11.0	11.0	11.0	11.1	12.4	12.4	12.4	12.4	13.9	13.9	13.9	14.0	
	Hi PR	274	276	278	282	318	319	321	326	363	364	366	371	412	413	415	420	465	466	466	472	521	522	524	529	
	Lo PR	120	120	120	127	138	123	126	133	144	128	131	138	150	132	135	142	154	135	139	146	158	140	144	151	163
	MBh	31.5	32.0	32.9	34.3	30.5	30.9	31.8	33.2	28.9	29.4	30.2	31.6	26.9	27.3	28.4	29.5	24.6	25.0	25.9	27.1	22.6	23.0	23.8	25.0	
	S/T	0.92	0.85	0.71	0.57	0.99	0.86	0.72	0.58	1.00	0.89	0.75	0.60	1.00	0.91	0.77	0.63	1.01	0.94	0.80	0.65	1.01	1.01	0.86	0.71	
	ΔT	27	25	22	18	26	24	21	18	26	24	21	17	25	23	20	17	24	22	19	16	24	23	20	17	
kW	2.05	2.04	2.04	2.06	2.29	2.29	2.28	2.30	2.56	2.56	2.55	2.57	2.85	2.85	2.84	2.86	3.17	3.17	3.16	3.18	3.54	3.54	3.53	3.55		
Amps	7.6	7.6	7.6	7.7	8.7	8.7	8.7	8.8	9.9	9.9	9.8	9.9	11.1	11.1	11.1	11.2	12.5	12.4	12.4	12.5	14.0	14.0	14.0	14.1		
Hi PR	277	278	280	285	321	322	324	328	366	367	369	374	415	416	416	423	467	469	470	475	524	525	527	531		
Lo PR	119	122	129	140	125	128	135	147	130	133	140	152	134	137	146	156	137	141	148	160	142	146	153	165		
MBh	32.1	32.6	33.5	34.9	31.1	31.5	32.4	33.8	29.5	29.9	30.8	32.1	27.4	27.8	28.7	30.0	25.2	25.6	26.4	27.7	23.1	23.5	24.3	25.5		
S/T	0.96	0.88	0.75	0.61	0.99	0.89	0.76	0.61	1.00	0.92	0.79	0.64	1.00	0.95	0.81	0.67	1.01	0.98	0.84	0.69	1.01	1.01	0.89	0.75		
ΔT	26	24	20	17	25	23	20	16	25	23	20	16	24	22	19	16	23	21	18	15	23	22	19	16		
kW	2.06	2.06	2.05	2.07	2.30	2.30	2.30	2.32	2.57	2.57	2.57	2.59	2.86	2.86	2.86	2.88	3.18	3.18	3.18	3.19	3.55	3.55	3.55	3.57		
Amps	7.7	7.7	7.7	7.8	8.8	8.7	8.7	8.8	9.9	9.9	9.9	10.0	11.2	11.1	11.1	11.2	12.5	12.5	12.5	12.6	14.1	14.1	14.0	14.1		
Hi PR	280	281	283	288	323	324	326	331	369	370	372	376	417	419	421	425	470	471	473	478	526	527	529	534		
Lo PR	122	125	132	143	127	131	138	149	132	136	143	154	136	139	147	158	140	143	150	162	144	148	155	167		
85	MBh	31.7	32.0	32.9	34.4	30.5	31.0	31.9	33.2	29.0	29.4	30.3	31.6	26.9	27.3	28.2	29.5	24.7	25.1	25.9	27.2	22.6	23.0	23.8	25.1	
	S/T	0.99	0.87	0.74	0.59	0.99	0.88	0.75	0.60	1.00	0.91	0.78	0.63	1.00	1.00	0.80	0.65	1.01	1.01	0.82	0.68	1.01	1.01	0.88	0.73	
	ΔT	35	30	27	23	31	29	26	22	30	29	25	22	29	28	25	21	28	27	24	20	29	27	24	21	
	kW	1.83	2.03	2.03	2.05	2.28	2.28	2.27	2.29	2.55	2.55	2.54	2.56	2.84	2.84	2.83	2.85	3.16	3.16	3.15	3.17	3.53	3.53	3.52	3.54	
	Amps	6.8	7.6	7.6	7.6	8.6	8.6	8.6	8.7	9.8	9.8	9.8	9.9	11.1	11.0	11.0	11.1	12.4	12.4	12.4	12.5	14.0	14.0	13.9	14.0	
	Hi PR	276	277	279	284	319	320	322	327	364	366	367	372	413	414	416	421	466	467	469	474	522	523	525	530	
	Lo PR	122	122	129	140	125	128	135	146	130	133	140	151	134	137	144	156	137	141	148	159	142	145	153	164	
	MBh	32.1	32.5	33.4	34.8	31.0	31.4	32.3	33.7	29.4	29.8	30.7	32.1	27.4	27.8	28.6	29.9	25.1	25.5	26.3	27.6	23.1	23.4	24.2	25.5	
	S/T	0.99	0.95	0.81	0.67	0.99	0.96	0.82	0.68	1.00	0.99	0.85	0.71	1.00	1.00	0.88	0.73	1.01	1.01	0.90	0.76	1.01	1.01	0.96	0.81	
	ΔT	30	29	25	22	30	28	25	21	29	27	24	21	28	26	23	20	27	25	22	19	27	26	23	20	
kW	2.05	2.05	2.04	2.06	2.30	2.29	2.29	2.31	2.57	2.56	2.56	2.58	2.85	2.85	2.85	2.87	3.17	3.17	3.17	3.19	3.55	3.54	3.54	3.56		
Amps	7.7	7.6	7.6	7.7	8.7	8.7	8.7	8.8	9.9	9.9	9.9	9.9	11.1	11.1	11.1	11.2	12.5	12.5	12.4	12.5	14.0	14.0	14.0	14.1		
Hi PR	279	280	282	286	322	323	325	330	367	368	370	375	416	417	419	424	469	470	472	477	525	526	528	533		
Lo PR	121	124	131	142	127	130	137	149	132	135	142	154	136	139	146	158	139	143	150	162	144	147	155	167		
MBh	32.7	33.1	34.0	35.4	31.6	32.0	32.9	34.3	30.0	30.4	31.3	32.6	27.9	28.3	29.2	30.5	25.6	26.0	26.9	28.1	23.6	24.0	24.8	26.0		
S/T	0.99	0.99	0.85	0.71	0.99	0.99	0.86	0.72	1.00	1.00	0.89	0.75	1.00	1.00	0.91	0.77	1.01	1.01	0.94	0.79	1.01	1.01	1.00	0.85		
ΔT	29	28	24	21	29	27	23	20	28	26	23	20	27	25	22	19	26	24	21	18	26	25	22	19		
kW	2.06	2.06	2.06	2.08	2.31	2.31	2.30	2.32	2.58	2.58	2.57	2.59	2.87	2.87	2.86	2.88	3.19	3.18	3.18	3.20	3.56	3.56	3.55	3.57		
Amps	7.7	7.7	7.7	7.8	8.8	8.8	8.7	8.8	9.9	9.9	9.9	10.0	11.2	11.2	11.1	11.2	12.5	12.5	12.5	12.6	14.1	14.1	14.1	14.1		
Hi PR	281	282	284	289	325	326	328	332	370	371	373	378	419	420	422	427	471	473	475	479	528	529	531	535		
Lo PR	123	127	133	145	129	132	139	151	134	137	144	156	138	141	148	160	141	145	152	164	146	150	157	169		

IDB = Entering Indoor Dry Bulb Temperature
 High and low pressures are measured at the liquid and suction service valves.
 Airflow may vary depending on actual ambient conditions and system operation modes.
 Shaded area is AHRI conditions.
 kW = Total system power
 Amps = outdoor unit amps (comp. + fan)

EXPANDED COOLING DATA — GXV6SS3610A* / AHVE36CP1300A*

IDB	OUTDOOR AMBIENT TEMPERATURE												ENTERING INDOOR WET BULB TEMPERATURE												
	65°F				75°F				85°F				95°F				105°F				115°F				
	59	63	67	71	59	63	67	71	59	63	67	71	59	63	67	71	59	63	67	71	59	63	67	71	
70	MBh	30.3	34.1	39.0	36.0	36.5	37.6	34.0	34.5	35.5	31.4	31.9	32.9	28.6	29.1	30.1	26.7	27.1	28.1	28.6	29.1	30.1	26.7	27.1	28.1
	S/T	0.65	0.55	0.39	0.61	0.53	0.39	0.63	0.56	0.42	0.65	0.57	0.44	0.67	0.59	0.46	1.00	0.66	0.52	0.67	0.59	0.46	1.00	0.66	0.52
	ΔT	21	20	14	19	17	14	19	17	14	18	16	13	17	15	12	20	18	15	17	15	12	20	18	15
	kW	1.75	1.99	2.68	3.03	3.03	3.03	3.42	3.42	3.41	3.83	3.83	3.83	4.30	4.29	4.29	4.38	4.38	4.37	4.30	4.29	4.29	4.38	4.38	4.37
	Amps	6.3	7.2	10.0	11.5	11.4	11.4	13.1	13.1	13.0	14.8	14.8	14.7	16.6	16.6	16.6	16.9	16.9	16.9	16.6	16.6	16.6	16.9	16.9	16.9
	Hi PR	282	287	295	333	334	336	375	376	378	420	421	423	466	468	469	514	515	517	466	468	469	514	515	517
	Lo PR	119	119	121	120	123	129	127	130	136	133	135	142	139	141	148	147	150	157	139	141	148	147	150	157
	MBh	32.5	37.5	39.6	36.5	37.0	38.1	34.5	35.0	36.1	32.0	32.5	33.5	29.2	29.6	30.6	27.2	27.6	28.6	29.2	29.6	30.6	27.2	27.6	28.6
	S/T	0.73	0.63	0.47	0.69	0.61	0.47	0.71	0.63	0.49	0.73	0.65	0.51	0.75	0.67	0.53	1.00	0.74	0.60	0.75	0.67	0.53	1.00	0.74	0.60
	ΔT	20	18	13	18	16	13	17	16	12	16	15	12	16	14	11	18	17	13	16	14	11	18	17	13
kW	1.89	2.27	2.70	3.06	3.05	3.05	3.44	3.44	3.43	3.86	3.85	3.85	4.32	4.32	4.31	4.40	4.40	4.39	4.32	4.32	4.31	4.40	4.40	4.39	
Amps	6.8	8.3	10.0	11.6	11.5	11.5	13.2	13.2	13.2	14.9	14.8	14.8	16.7	16.7	16.7	17.0	17.0	16.9	16.7	16.7	16.7	17.0	17.0	16.9	
Hi PR	287	293	298	336	337	339	378	379	381	422	424	426	469	470	472	517	518	520	469	470	472	517	518	520	
Lo PR	120	119	123	122	125	131	129	132	138	135	138	144	141	143	150	149	152	159	141	143	150	149	152	159	
MBh	37.7	39.2	40.3	37.2	37.7	38.8	35.2	35.7	36.8	32.6	33.1	34.1	29.8	30.3	31.3	27.8	28.3	29.2	29.8	30.3	31.3	27.8	28.3	29.2	
S/T	0.75	0.64	0.50	0.73	0.65	0.51	0.75	0.67	0.53	0.77	0.69	0.55	0.79	0.71	0.57	1.00	0.78	0.64	0.79	0.71	0.57	1.00	0.78	0.64	
ΔT	19	15	12	17	15	12	16	15	11	15	14	11	15	13	10	17	15	12	15	13	10	17	15	12	
kW	2.29	2.73	2.72	3.07	3.07	3.07	3.46	3.46	3.45	3.87	3.87	3.87	4.34	4.33	4.33	4.41	4.41	4.41	4.34	4.33	4.33	4.41	4.41	4.41	
Amps	8.4	10.2	10.1	11.6	11.6	11.6	13.2	13.2	13.2	14.9	14.9	14.9	16.8	16.8	16.7	17.0	17.0	17.0	16.8	16.8	16.7	17.0	17.0	17.0	
Hi PR	295	299	301	339	340	342	381	382	384	425	426	428	472	473	475	519	521	522	472	473	475	519	521	522	
Lo PR	119	119	126	125	127	133	131	134	140	137	140	147	143	146	153	151	154	161	143	146	153	151	154	161	

1070	MBh	30.3	34.1	39.0	40.7	36.0	36.5	37.6	39.2	34.0	34.5	35.6	37.2	31.5	31.9	33.0	34.5	28.7	29.1	30.1	31.6	26.7	27.1	28.1	29.6
	S/T	0.80	0.69	0.52	0.37	0.74	0.66	0.53	0.38	0.77	0.69	0.55	0.40	0.78	0.71	0.57	0.42	1.00	0.73	0.59	0.44	1.00	0.80	0.66	0.51
	ΔT	26	24	18	15	23	21	17	14	22	21	17	14	21	20	17	13	20	19	16	13	23	22	18	15
	kW	1.75	1.98	2.68	2.70	3.03	3.03	3.02	3.05	3.42	3.41	3.41	3.43	3.83	3.83	3.82	3.85	4.30	4.29	4.29	4.31	4.38	4.37	4.37	4.39
	Amps	6.3	7.2	9.9	10.1	11.4	11.4	11.4	11.5	13.1	13.0	13.0	13.1	14.8	14.7	14.7	14.8	16.6	16.6	16.6	16.7	16.9	16.9	16.9	17.0
	Hi PR	282	287	295	300	333	334	336	342	375	377	379	384	420	421	423	428	467	468	470	475	514	515	517	522
	Lo PR	119	119	121	132	120	123	129	140	127	130	136	147	133	136	142	154	139	141	148	160	147	150	157	169
	MBh	32.5	37.5	39.6	41.3	36.5	37.1	38.1	39.8	34.6	35.1	36.1	37.7	32.0	32.5	33.5	35.1	29.2	29.6	30.6	32.2	27.2	27.7	28.6	30.1
	S/T	0.87	0.77	0.60	0.45	0.82	0.74	0.60	0.46	0.84	0.76	0.63	0.48	1.00	0.78	0.64	0.50	1.00	0.80	0.66	0.52	1.00	0.87	0.73	0.59
	ΔT	24	23	17	14	21	20	16	13	21	19	16	13	20	18	15	12	19	18	15	12	22	20	17	14
kW	1.88	2.27	2.70	2.73	3.05	3.05	3.05	3.07	3.44	3.44	3.43	3.46	3.85	3.85	3.85	3.87	4.32	4.31	4.31	4.34	4.40	4.39	4.39	4.41	
Amps	6.8	8.3	10.0	10.2	11.5	11.5	11.5	11.6	13.1	13.1	13.1	13.2	14.8	14.8	14.8	14.9	16.7	16.7	16.7	16.8	17.0	17.0	16.9	17.0	
Hi PR	287	293	298	303	336	337	339	344	378	380	382	387	423	424	426	431	469	471	473	477	517	518	520	525	
Lo PR	120	119	123	134	122	125	131	142	129	132	138	149	135	138	144	156	141	143	150	162	149	152	159	171	
MBh	37.7	39.2	40.3	42.0	37.2	37.8	38.8	40.5	35.2	35.7	36.8	38.4	32.7	33.1	34.2	35.7	29.8	30.3	31.3	32.8	27.8	28.3	29.3	30.8	
S/T	0.89	0.78	0.64	0.49	0.86	0.78	0.64	0.50	0.88	0.80	0.67	0.52	1.00	0.82	0.68	0.54	1.00	0.84	0.70	0.56	1.00	0.91	0.77	0.63	
ΔT	24	19	16	12	20	19	15	12	20	18	15	12	19	17	14	11	18	17	14	11	21	19	16	13	
kW	2.29	2.72	2.72	2.74	3.07	3.07	3.06	3.09	3.46	3.45	3.45	3.47	3.87	3.87	3.86	3.89	4.34	4.33	4.33	4.35	4.41	4.41	4.40	4.43	
Amps	8.4	10.1	10.1	10.2	11.6	11.6	11.6	11.7	13.2	13.2	13.2	13.3	14.9	14.9	14.9	15.0	16.8	16.7	16.7	16.8	17.0	17.0	17.0	17.1	
Hi PR	295	299	301	306	339	340	342	347	381	382	384	389	425	427	429	434	472	473	475	480	520	521	523	527	
Lo PR	119	119	126	136	125	127	133	145	131	134	140	152	137	140	147	158	143	146	153	165	151	154	161	174	

IDB = Entering Indoor Dry Bulb Temperature
 High and low pressures are measured at the liquid and suction service valves.
 Airflow may vary depending on actual ambient conditions and system operation modes.
 Shaded area is ACCA (TVA) conditions.
 kW = Total system power
 Amps = outdoor unit amps (comp.+fan)

EXPANDED COOLING DATA — GXV6SS3610A* / AHVE36CP1300A* (CONT.)

IDB	AIRFLOW	OUTDOOR AMBIENT TEMPERATURE												ENTERING INDOOR WET BULB TEMPERATURE												
		65°F				75°F				85°F				95°F				105°F				115°F				
		59	63	67	71	59	63	67	71	59	63	67	71	59	63	67	71	59	63	67	71	59	63	67	71	
80	MBh	30.5	34.3	39.2	40.9	36.2	36.7	37.8	39.4	34.2	34.7	35.8	37.4	31.6	32.1	33.1	34.7	28.8	29.3	30.3	31.8	26.8	27.3	28.3	29.8	
	S/T	0.93	0.83	0.65	0.50	0.87	0.79	0.65	0.51	1.01	0.82	0.68	0.53	1.00	0.83	0.69	0.55	1.00	0.85	0.72	0.57	1.00	1.00	0.79	0.64	
	ΔT	30	28	22	19	26	25	22	18	26	24	21	18	25	23	20	17	24	22	19	16	27	25	22	19	
	kW	1.75	1.98	2.68	2.71	3.03	3.03	3.02	3.05	3.42	3.42	3.41	3.44	3.83	3.83	3.82	3.85	4.30	4.29	4.29	4.31	4.38	4.38	4.37	4.39	
	Amps	6.3	7.2	9.9	10.1	11.5	11.4	11.4	11.5	13.1	13.0	13.0	13.1	14.8	14.7	14.7	14.8	16.6	16.6	16.6	16.7	16.9	16.9	16.9	17.0	
	Hi PR	283	288	296	301	334	335	337	342	376	377	379	384	420	422	423	428	467	468	470	475	515	516	518	522	
	Lo PR	120	120	122	132	121	123	130	141	128	130	132	148	133	136	143	154	139	142	149	161	147	150	157	169	
	MBh	34.3	37.7	39.8	41.5	36.7	37.2	38.3	40.0	34.7	35.2	36.3	37.9	32.2	32.7	33.7	35.2	29.4	29.8	30.8	32.3	27.4	27.8	28.8	30.3	
	S/T	0.99	0.90	0.73	0.58	1.01	0.87	0.73	0.58	1.01	0.89	0.75	0.61	1.00	0.91	0.77	0.63	1.00	0.93	0.79	0.65	1.00	1.00	0.86	0.72	
	ΔT	29	27	21	18	25	23	20	17	25	23	20	17	24	22	19	16	23	21	18	15	26	24	21	18	
kW	2.00	2.27	2.70	2.73	3.06	3.05	3.05	3.07	3.44	3.44	3.43	3.46	3.86	3.85	3.85	3.87	4.32	4.32	4.31	4.34	4.40	4.39	4.39	4.41		
Amps	7.3	8.3	10.0	10.2	11.5	11.5	11.5	11.6	13.2	13.1	13.1	13.2	14.9	14.8	14.8	14.9	16.7	16.7	16.7	16.8	17.0	17.0	16.9	17.0		
Hi PR	289	294	299	304	337	338	340	345	379	380	382	387	423	424	426	431	470	471	473	478	517	519	521	525		
Lo PR	120	120	124	134	123	125	132	143	130	132	139	150	135	138	146	156	141	144	151	163	149	152	159	172		
1450	MBh	37.9	39.4	40.5	42.2	37.4	38.0	39.0	40.7	35.4	35.9	37.0	38.6	32.8	33.3	34.3	35.9	30.0	30.5	31.5	33.0	28.0	28.5	29.4	30.9	
	S/T	1.01	0.90	0.77	0.62	1.01	0.91	0.77	0.62	1.01	0.93	0.79	0.65	1.00	0.95	0.81	0.67	1.00	1.00	0.83	0.69	1.00	1.00	0.90	0.76	
	ΔT	28	23	20	16	24	22	19	16	24	22	19	16	23	21	18	15	22	20	17	14	25	23	20	17	
	kW	2.29	2.73	2.72	2.75	3.07	3.07	3.07	3.09	3.46	3.46	3.45	3.48	3.87	3.87	3.87	3.89	4.34	4.33	4.33	4.35	4.41	4.41	4.41	4.43	
	Amps	8.4	10.2	10.1	10.2	11.6	11.6	11.6	11.7	13.2	13.2	13.2	13.3	14.9	14.9	14.9	15.0	16.8	16.8	16.7	16.8	17.0	17.0	17.0	17.1	
	Hi PR	296	300	302	307	340	341	343	348	382	383	385	390	426	427	429	434	473	474	476	481	520	521	523	528	
	Lo PR	120	120	126	137	125	128	134	145	132	134	141	152	138	140	147	159	144	146	153	165	152	154	162	174	
	860	MBh	31.7	32.0	32.9	34.4	30.5	31.0	31.9	33.2	29.0	29.4	30.3	31.6	26.9	27.3	28.2	29.5	24.7	25.1	25.9	27.2	22.6	23.0	23.8	25.1
		S/T	0.99	0.87	0.74	0.59	0.99	0.88	0.75	0.60	1.00	0.91	0.78	0.63	1.00	1.00	0.80	0.65	1.01	1.01	0.82	0.68	1.01	1.01	0.88	0.73
		ΔT	35	30	27	23	31	29	26	22	30	29	25	22	29	28	25	21	28	27	24	20	29	27	24	21
kW		1.83	2.03	2.03	2.05	2.28	2.28	2.27	2.29	2.55	2.55	2.54	2.56	2.84	2.84	2.83	2.85	3.16	3.16	3.15	3.17	3.53	3.53	3.52	3.54	
Amps		6.8	7.6	7.6	7.6	8.6	8.6	8.6	8.7	9.8	9.8	9.8	9.9	11.1	11.0	11.0	11.1	12.4	12.4	12.4	12.5	14.0	14.0	13.9	14.0	
Hi PR		276	277	279	284	319	320	322	327	364	366	367	372	413	414	416	421	466	467	469	474	522	523	525	530	
Lo PR		122	122	129	140	125	128	135	146	130	133	140	151	134	137	144	156	137	141	148	159	142	145	153	164	
1260		MBh	37.8	39.3	40.4	42.1	37.3	37.9	38.9	40.6	35.3	35.8	36.9	38.5	32.7	33.2	34.3	35.8	29.9	30.4	31.4	32.9	27.9	28.4	29.4	30.9
		S/T	1.01	0.97	0.83	0.68	1.01	0.97	0.83	0.69	1.01	1.00	0.86	0.71	1.00	1.00	0.87	0.73	1.00	1.00	0.89	0.75	1.00	1.00	1.00	0.82
		ΔT	33	28	24	21	29	27	24	20	28	26	23	20	27	25	22	19	26	24	21	18	29	27	24	21
	kW	2.28	2.71	2.71	2.74	3.06	3.06	3.05	3.08	3.45	3.44	3.44	3.47	3.86	3.86	3.85	3.88	4.33	4.32	4.32	4.34	4.40	4.40	4.40	4.42	
	Amps	8.3	10.1	10.1	10.2	11.6	11.6	11.5	11.7	13.2	13.2	13.1	13.3	14.9	14.9	14.8	15.0	16.7	16.7	16.7	16.8	17.0	17.0	17.0	17.1	
	Hi PR	294	298	300	305	338	339	341	346	380	381	383	388	425	426	428	433	471	472	474	479	519	520	522	527	
	Lo PR	119	119	126	136	125	127	133	145	131	134	140	152	137	140	147	158	143	146	153	165	151	154	161	174	
	1160	MBh	32.7	33.1	34.0	35.4	31.6	32.0	32.9	34.3	30.0	30.4	31.3	32.6	27.9	28.3	29.2	30.5	25.6	26.0	26.9	28.1	23.6	24.0	24.8	26.0
		S/T	0.99	0.99	0.85	0.71	0.99	0.99	0.86	0.72	1.00	1.00	0.89	0.75	1.00	1.00	0.91	0.77	1.01	1.01	0.94	0.79	1.01	1.01	1.00	0.85
		ΔT	29	28	24	21	29	27	23	20	28	26	23	20	27	25	22	19	26	24	21	18	26	25	22	19
kW		2.06	2.06	2.06	2.08	2.31	2.31	2.30	2.32	2.58	2.58	2.57	2.59	2.87	2.87	2.86	2.88	3.19	3.18	3.18	3.20	3.56	3.56	3.55	3.57	
Amps		7.7	7.7	7.7	7.8	8.8	8.8	8.7	8.8	9.9	9.9	9.9	10.0	11.2	11.2	11.1	11.2	12.5	12.5	12.5	12.6	14.1	14.1	14.1	14.1	
Hi PR		281	282	284	289	325	326	328	332	370	371	373	378	419	420	422	427	471	473	475	479	528	529	531	535	
Lo PR		123	127	133	145	129	132	139	151	134	137	144	156	138	141	148	160	141	145	152	164	146	150	157	169	

IDB = Entering Indoor Dry Bulb Temperature
 High and low pressures are measured at the liquid and suction service valves.
 Airflow may vary depending on actual ambient conditions and system operation modes.
 Shaded area is AHRI conditions.
 kW = Total system power
 Amps = outdoor unit amps (comp. fan)

EXPANDED COOLING DATA — GXV6SS4210A* / AHVE48DP1300A*

IDB	AIRFLOW	OUTDOOR AMBIENT TEMPERATURE												ENTERING INDOOR WET BULB TEMPERATURE											
		65°F				75°F				85°F				95°F				105°F				115°F			
		59	63	67	71	59	63	67	71	59	63	67	71	59	63	67	71	59	63	67	71	59	63	67	71
70	MBh	33.5	42.3	43.6	43.1	41.3	41.9	43.1	41.9	40.1	40.7	41.9	41.9	38.1	38.7	40.0	40.0	35.8	36.3	37.6	37.6	29.5	30.0	31.1	31.1
	S/T	0.59	0.50	0.37	0.37	0.58	0.50	0.37	0.40	0.60	0.53	0.40	0.40	0.62	0.54	0.41	0.41	0.64	0.56	0.43	0.43	0.70	0.62	0.49	0.49
	ΔT	21	19	15	15	20	19	15	15	21	19	15	15	20	18	15	15	20	18	15	15	22	20	16	16
	kW	1.66	3.32	3.31	3.69	3.70	3.70	3.69	4.09	4.11	4.10	4.09	4.09	4.53	4.53	4.52	4.52	4.99	4.99	4.98	4.98	3.11	3.11	3.10	3.10
	Amps	8.2	14.7	14.7	15.8	15.9	15.8	15.8	16.8	16.9	16.9	16.8	16.8	17.7	17.7	17.7	17.7	18.5	18.5	18.4	18.4	11.1	11.1	11.0	11.0
	Hi PR	261	280	282	327	324	325	327	374	371	372	374	374	422	423	425	425	477	478	480	480	514	515	517	517
	Lo PR	119	119	127	133	120	125	133	137	124	129	137	137	127	132	140	140	130	136	144	144	138	144	152	152
	MBh	37.8	43.0	44.2	43.8	41.9	42.5	43.8	42.6	40.7	41.3	42.6	42.6	38.8	39.4	40.6	40.6	36.4	37.0	38.2	38.2	30.1	30.6	31.7	31.7
	S/T	0.65	0.57	0.44	0.45	0.65	0.58	0.45	0.47	0.67	0.60	0.47	0.47	0.69	0.62	0.49	0.49	0.71	0.64	0.51	0.51	0.77	0.70	0.57	0.57
	ΔT	20	17	14	14	19	17	14	14	19	17	14	14	19	17	14	14	19	17	13	13	20	19	15	15
	kW	1.99	3.35	3.34	3.72	3.73	3.72	3.72	4.12	4.13	4.13	4.12	4.12	4.56	4.55	4.55	4.55	5.02	5.01	5.01	5.01	3.12	3.12	3.12	3.12
	Amps	9.4	14.9	14.9	15.9	16.0	16.0	15.9	17.0	17.0	17.0	17.0	17.0	17.9	17.8	17.8	17.8	18.6	18.6	18.5	18.5	11.1	11.1	11.1	11.1
Hi PR	271	283	285	330	327	328	330	377	374	375	377	377	425	426	428	428	480	481	483	483	517	518	520	520	
Lo PR	120	121	129	131	122	127	135	142	126	131	139	139	129	134	142	142	132	137	146	146	140	146	154	154	
MBh	42.9	43.8	45.0	44.6	42.7	43.3	44.6	43.4	41.5	42.1	43.4	43.4	39.6	40.2	41.4	41.4	37.2	37.8	39.0	39.0	30.8	31.3	32.4	32.4	
S/T	0.67	0.61	0.48	0.48	0.69	0.61	0.48	0.51	0.71	0.64	0.51	0.51	0.73	0.65	0.52	0.52	0.75	0.67	0.54	0.54	0.81	0.73	0.60	0.60	
ΔT	19	16	13	13	18	16	13	13	18	16	13	13	18	16	12	12	17	16	12	12	19	17	14	14	
kW	2.42	3.37	3.37	3.74	3.75	3.75	3.74	4.15	4.16	4.15	4.15	4.15	4.58	4.58	4.57	4.57	5.04	5.04	5.03	5.03	3.13	3.13	3.13	3.13	
Amps	10.9	15.0	15.0	16.0	16.1	16.1	16.0	17.1	17.1	17.1	17.1	17.1	17.9	17.9	17.9	17.9	18.7	18.6	18.6	18.6	11.2	11.1	11.1	11.1	
Hi PR	283	286	288	333	330	331	333	380	377	378	380	380	428	429	431	431	483	484	486	486	519	521	522	522	
Lo PR	120	124	131	137	124	129	137	148	128	133	142	142	131	137	145	145	134	140	148	148	142	148	157	157	

75	MBh	33.5	42.4	43.6	45.5	41.3	41.9	43.1	45.0	40.1	40.7	41.9	43.8	38.2	38.7	40.0	41.9	35.8	36.4	37.6	39.5	29.6	30.1	31.2	32.8
	S/T	0.72	0.62	0.49	0.35	0.70	0.63	0.50	0.36	0.72	0.65	0.52	0.38	0.74	0.67	0.54	0.40	0.76	0.69	0.56	0.42	1.00	0.75	0.62	0.48
	ΔT	25	23	19	16	25	23	19	16	25	23	19	16	24	22	19	15	24	22	19	15	26	24	21	17
	kW	1.66	3.32	3.31	3.34	3.70	3.69	3.69	3.72	4.10	4.10	4.09	4.13	4.53	4.52	4.52	4.55	4.99	4.98	4.98	5.01	3.11	3.10	3.10	3.12
	Amps	8.2	14.7	14.7	14.9	15.8	15.8	15.8	16.0	16.9	16.9	16.8	17.0	17.7	17.7	17.7	17.8	18.5	18.5	18.4	18.5	11.1	11.1	11.0	11.0
	Hi PR	261	281	282	287	324	325	327	332	371	373	374	379	422	423	425	430	477	479	481	485	514	515	517	522
	Lo PR	119	119	127	138	120	125	133	144	124	129	137	148	127	133	140	152	130	136	144	155	138	144	152	164
	MBh	37.8	43.0	44.3	46.2	41.9	42.5	43.8	45.7	40.8	41.3	42.6	44.5	38.8	39.4	40.6	42.5	36.4	37.0	38.2	40.1	30.1	30.6	31.7	33.4
	S/T	0.78	0.70	0.57	0.43	0.78	0.70	0.57	0.43	0.80	0.72	0.59	0.46	0.81	0.74	0.61	0.47	0.83	0.76	0.63	0.49	1.00	0.82	0.69	0.55
	ΔT	24	21	18	14	23	21	18	14	23	21	18	14	23	21	18	14	23	21	17	14	25	23	19	15
	kW	1.99	3.35	3.34	3.37	3.72	3.72	3.71	3.75	4.13	4.13	4.12	4.15	4.55	4.55	4.54	4.58	5.01	5.01	5.00	5.04	3.12	3.12	3.11	3.13
	Amps	9.4	14.9	14.8	15.0	16.0	16.0	15.9	16.1	17.0	17.0	16.9	17.1	17.8	17.8	17.9	18.6	18.6	18.6	18.5	18.6	11.1	11.1	11.1	11.0
Hi PR	272	283	285	290	327	328	330	335	374	375	377	382	425	426	428	433	480	481	483	488	517	518	520	525	
Lo PR	120	121	129	140	122	127	135	146	126	131	139	151	129	134	143	154	132	138	146	157	140	146	154	166	
MBh	42.9	43.8	45.1	47.0	42.8	43.3	44.6	46.5	41.6	42.1	43.4	45.3	39.6	40.2	41.4	43.3	37.2	37.8	39.0	40.9	30.8	31.3	32.4	34.1	
S/T	0.80	0.73	0.60	0.46	0.81	0.74	0.61	0.47	0.83	0.76	0.63	0.49	0.85	0.78	0.65	0.51	1.00	0.80	0.67	0.53	1.00	0.86	0.73	0.59	
ΔT	24	20	17	13	22	20	17	13	22	20	17	13	22	20	16	13	21	20	16	13	24	22	18	14	
kW	2.41	3.37	3.36	3.40	3.75	3.74	3.74	3.77	4.15	4.15	4.14	4.18	4.58	4.57	4.57	4.60	5.04	5.03	5.03	5.06	3.13	3.13	3.13	3.14	
Amps	10.9	15.0	15.0	15.1	16.1	16.1	16.0	16.2	17.1	17.1	17.0	17.2	17.9	17.9	17.9	18.0	18.6	18.6	18.6	18.7	11.1	11.1	11.1	11.0	
Hi PR	283	286	288	293	330	331	333	338	377	378	380	385	428	429	431	436	483	484	486	491	520	521	523	527	
Lo PR	120	124	132	143	124	129	137	148	128	133	142	153	131	137	145	156	134	140	148	160	142	148	157	169	

IDB = Entering Indoor Dry Bulb Temperature
 High and low pressures are measured at the liquid and suction service valves.
 Airflow may vary depending on actual ambient conditions and system operation modes.
 Shaded area is ACCA (TVA) conditions
 kW = Total system power
 Amps = outdoor unit amps (comp.+fan)

EXPANDED COOLING DATA — GXV6SS4210A* / AHVE48DP1300A* (CONT.)

IDB	AIRFLOW	OUTDOOR AMBIENT TEMPERATURE												ENTERING INDOOR WET BULB TEMPERATURE											
		65°F				75°F				85°F				95°F				105°F				115°F			
		59	63	67	71	59	63	67	71	59	63	67	71	59	63	67	71	59	63	67	71	59	63	67	71
80	MBh	34.9	42.6	43.8	45.7	41.5	42.1	43.4	45.3	40.3	40.9	42.2	44.1	38.4	39.0	40.2	42.1	36.0	36.6	37.8	39.7	29.7	30.3	31.3	33.0
	S/T	0.84	0.75	0.61	0.48	0.82	0.75	0.62	0.48	1.00	0.77	0.64	0.50	1.00	0.79	0.66	0.52	1.00	0.81	0.68	0.54	1.00	0.87	0.74	0.60
	ΔT	30	27	23	20	29	27	23	20	29	27	23	20	28	27	23	20	28	26	23	19	30	28	25	21
	kW	1.76	3.32	3.31	3.35	3.70	3.70	3.69	3.72	4.11	4.10	4.09	4.13	4.53	4.53	4.52	4.55	4.99	4.99	4.98	5.01	3.11	3.11	3.10	3.12
	Amps	8.6	14.7	14.7	14.9	15.9	15.8	15.8	16.0	16.9	16.9	16.8	17.0	17.7	17.7	17.7	17.8	18.5	18.5	18.4	18.6	11.1	11.1	11.0	11.0
	Hi PR	264	281	283	288	325	326	328	333	372	373	375	380	423	424	426	431	478	479	481	486	515	516	518	522
	Lo PR	119	120	127	138	120	125	133	144	124	130	138	149	128	133	141	152	131	136	144	156	139	144	153	165
	MBh	38.0	43.2	44.5	46.4	42.2	42.8	44.0	45.9	41.0	41.6	42.8	44.7	39.0	39.6	41.0	42.7	36.6	37.2	38.5	40.4	30.3	30.8	31.9	33.6
	S/T	0.90	0.82	0.69	0.55	0.90	0.82	0.69	0.55	1.00	0.85	0.71	0.58	1.00	0.86	0.73	0.59	1.00	0.88	0.75	0.61	1.00	0.81	0.67	
	ΔT	29	26	22	18	27	25	22	18	27	26	22	18	27	25	22	18	27	25	21	18	29	27	23	20
	kW	1.99	3.35	3.34	3.38	3.73	3.72	3.72	3.75	4.13	4.13	4.12	4.16	4.56	4.55	4.56	4.58	5.02	5.01	5.01	5.04	3.12	3.12	3.12	3.13
	Amps	9.4	14.9	14.8	15.0	16.0	16.0	15.9	16.1	17.0	17.0	17.0	17.1	17.9	17.8	17.8	18.7	18.6	18.6	18.5	18.7	11.1	11.1	11.1	11.0
Hi PR	272	284	286	291	328	329	331	336	375	376	378	383	426	427	429	434	481	482	484	489	517	519	520	525	
Lo PR	120	122	130	141	122	127	135	147	126	132	140	151	130	135	145	155	133	138	146	158	141	146	155	167	
MBh	43.4	44.0	45.3	47.2	43.0	43.6	44.8	46.7	41.8	42.4	43.6	45.5	39.8	40.4	41.6	43.5	37.4	38.0	39.3	41.2	31.0	31.5	32.6	34.3	
S/T	0.93	0.86	0.72	0.59	1.01	0.86	0.73	0.59	1.00	0.88	0.75	0.61	1.00	0.90	0.77	0.63	1.00	0.92	0.79	0.65	1.00	0.85	0.71		
ΔT	26	24	21	17	26	24	21	17	26	24	21	17	26	24	21	17	26	24	20	17	28	26	22	19	
kW	3.38	3.37	3.36	3.40	3.75	3.75	3.74	3.77	4.16	4.15	4.14	4.18	4.58	4.58	4.57	4.60	5.04	5.03	5.03	5.06	3.13	3.13	3.13	3.14	
Amps	15.0	15.0	15.0	15.1	16.1	16.1	16.0	16.2	17.1	17.1	17.1	17.2	17.9	17.9	17.9	18.0	18.7	18.6	18.6	18.7	11.2	11.1	11.1	11.0	
Hi PR	285	287	289	294	330	332	333	338	377	379	381	386	428	430	432	437	484	485	487	492	520	521	523	528	
Lo PR	119	124	132	143	124	130	138	149	129	134	142	154	132	137	145	157	135	140	148	160	143	149	157	169	
MBh	38.1	43.3	44.5	46.4	42.2	42.8	44.1	46.0	41.0	41.6	42.9	44.8	39.1	39.7	40.9	42.8	36.7	37.3	38.5	40.4	30.4	30.9	32.0	33.6	
S/T	1.01	0.84	0.71	0.57	1.01	0.85	0.72	0.58	1.00	0.87	0.74	0.60	1.00	0.89	0.76	0.62	1.00	1.00	0.78	0.64	1.00	0.84	0.70		
ΔT	34	31	27	23	32	30	27	23	32	31	27	24	32	30	27	23	32	30	26	23	34	32	29	25	
kW	1.98	3.33	3.32	3.36	3.71	3.70	3.70	3.73	4.11	4.11	4.10	4.14	4.54	4.53	4.53	4.56	5.00	4.99	4.99	5.02	3.11	3.11	3.11	3.12	
Amps	9.3	14.8	14.7	14.9	15.9	15.9	15.8	16.0	16.9	16.9	16.9	17.0	17.8	17.8	17.7	17.9	18.5	18.5	18.5	18.6	11.1	11.1	11.1	11.0	
Hi PR	271	282	284	289	326	327	329	334	373	374	376	381	424	425	427	432	479	480	482	487	516	517	519	524	
Lo PR	120	122	129	140	122	127	135	146	126	131	139	151	129	135	143	154	132	138	146	157	141	146	155	167	
MBh	43.0	43.9	45.2	47.1	42.9	43.5	44.7	46.6	41.7	42.3	43.5	45.4	39.7	40.3	41.5	43.4	37.3	37.9	39.2	41.1	30.9	31.4	32.5	34.2	
S/T	1.01	0.92	0.79	0.65	1.01	0.92	0.79	0.65	1.00	0.94	0.81	0.67	1.00	1.00	0.83	0.69	1.00	1.00	0.85	0.71	1.00	0.91	0.77		
ΔT	33	29	26	22	31	29	26	22	31	29	26	22	31	29	25	22	30	28	25	21	34	32	28	24	
kW	2.40	3.36	3.35	3.38	3.74	3.73	3.72	3.76	4.14	4.14	4.13	4.16	4.56	4.56	4.55	4.59	5.02	5.02	5.01	5.05	3.13	3.12	3.12	3.14	
Amps	10.9	14.9	14.9	15.1	16.0	16.0	16.0	16.1	17.0	17.0	17.0	17.1	17.9	17.9	17.8	18.0	18.6	18.6	18.6	18.7	11.1	11.1	11.1	11.0	
Hi PR	282	285	287	292	329	330	332	337	376	377	379	384	427	428	430	435	482	483	485	490	519	520	522	526	
Lo PR	120	124	131	143	124	129	137	148	128	133	141	153	131	137	145	156	134	140	148	159	140	145	154	167	
MBh	44.1	44.7	46.0	47.9	43.7	44.3	45.5	47.4	42.5	43.1	44.3	46.2	40.5	41.1	42.3	44.2	38.1	38.7	40.0	41.9	31.6	32.1	33.2	34.9	
S/T	1.01	0.95	0.82	0.68	1.01	0.96	0.83	0.69	1.00	1.00	0.85	0.71	1.00	1.00	0.87	0.73	1.00	1.00	0.88	0.75	1.00	0.90	0.81		
ΔT	30	28	25	21	30	28	24	21	30	28	25	21	30	28	24	21	29	27	24	20	32	30	26	22	
kW	3.38	3.38	3.37	3.41	3.76	3.75	3.75	3.78	4.16	4.16	4.15	4.19	4.59	4.58	4.58	4.61	5.05	5.04	5.04	5.07	3.14	3.14	3.13	3.15	
Amps	15.1	15.0	15.0	15.2	16.1	16.1	16.1	16.2	17.1	17.1	17.1	17.2	18.0	18.0	17.9	18.1	18.7	18.7	18.6	18.8	11.2	11.2	11.1	11.0	
Hi PR	287	288	290	295	332	333	335	340	379	380	382	387	430	431	433	438	485	486	488	493	521	523	524	529	
Lo PR	121	126	134	145	126	131	139	151	130	136	144	155	133	139	147	159	136	142	150	162	145	150	159	171	

IDB = Entering Indoor Dry Bulb Temperature
 High and low pressures are measured at the liquid and suction service valves.
 Airflow may vary depending on actual ambient conditions and system operation modes.

Shaded area is AHRI conditions.

kW = Total system power
 Amps = outdoor unit amps (comp. + fan)

EXPANDED COOLING DATA — GXV6SS4810A* / AHVE48DP1300A*

IDB	AIRFLOW	OUTDOOR AMBIENT TEMPERATURE												ENTERING INDOOR WET BULB TEMPERATURE											
		65°F				75°F				85°F				95°F				105°F				115°F			
		59	63	67	71	59	63	67	71	59	63	67	71	59	63	67	71	59	63	67	71	59	63	67	71
70	MBh	41.8	49.6	51.1	53.4	48.3	48.2	49.7	51.9	45.3	46.0	47.4	49.6	42.3	42.9	44.3	46.4	38.9	39.5	40.9	43.0	35.9	36.5	38.0	40.1
	S/T	0.56	0.49	0.36	0.34	0.55	0.49	0.37	0.35	0.59	0.52	0.39	0.39	0.62	0.54	0.41	0.41	0.64	0.57	0.44	0.42	0.70	0.62	0.49	0.49
	ΔT	23	20	17	17	23	20	16	16	22	20	16	16	21	19	15	15	20	18	15	15	21	20	16	16
	kW	2.24	3.71	3.70	3.74	3.38	4.10	4.10	4.10	4.53	4.53	4.52	4.52	4.97	4.96	4.96	4.96	5.43	5.43	5.42	5.42	5.43	5.43	5.42	5.42
	Amps	9.6	14.8	14.8	14.8	13.6	16.5	16.5	16.5	18.3	18.3	18.3	18.3	20.0	20.0	20.0	20.0	21.6	21.6	21.6	21.6	21.6	21.6	21.6	21.6
	Hi PR	280	293	295	303	343	337	339	345	382	383	385	385	431	432	434	434	483	484	486	486	483	484	486	486
	Lo PR	119	122	130	132	120	123	132	134	120	126	134	136	121	128	136	136	123	129	137	137	123	129	137	137
	MBh	47.3	50.4	51.9	54.1	48.3	49.0	50.4	52.6	46.0	46.7	48.1	49.6	43.0	43.7	45.0	46.4	39.6	40.2	41.6	43.0	36.6	37.2	38.6	40.1
	S/T	0.61	0.56	0.43	0.42	0.64	0.57	0.44	0.44	0.67	0.59	0.46	0.46	0.69	0.62	0.49	0.49	0.71	0.64	0.51	0.51	0.77	0.70	0.57	0.57
	ΔT	22	19	15	15	20	18	15	15	20	18	15	15	20	18	14	14	19	17	13	13	20	18	15	15
	kW	2.73	3.74	3.73	3.77	4.14	4.14	4.13	4.13	4.56	4.56	4.55	4.55	5.00	4.99	4.99	4.99	5.46	5.46	5.45	5.45	5.46	5.46	5.45	5.45
	Amps	11.2	14.9	14.9	15.0	16.7	16.6	16.6	16.7	18.5	18.4	18.4	18.4	20.1	20.1	20.1	20.1	21.7	21.7	21.7	21.7	21.7	21.7	21.7	21.7
Hi PR	293	296	298	301	339	340	342	345	385	386	388	388	434	435	437	437	486	487	489	489	486	487	489	489	
Lo PR	119	122	130	132	119	126	134	136	122	128	136	136	123	130	138	138	124	131	139	139	124	131	139	139	
MBh	51.4	51.3	52.8	54.1	49.2	49.9	51.3	53.5	47.0	47.6	49.0	49.6	43.9	44.5	45.9	47.2	40.5	41.1	42.5	43.9	37.5	38.1	39.5	41.0	
S/T	0.64	0.59	0.47	0.46	0.68	0.60	0.47	0.47	0.70	0.63	0.50	0.50	0.73	0.65	0.52	0.52	0.75	0.68	0.55	0.55	0.81	0.73	0.60	0.60	
ΔT	21	18	14	14	19	17	13	13	19	17	13	13	18	16	13	13	18	16	12	12	19	17	14	14	
kW	3.11	3.77	3.76	3.76	4.17	4.16	4.15	4.15	4.59	4.58	4.58	4.58	5.02	5.02	5.01	5.01	5.49	5.48	5.48	5.48	5.49	5.48	5.48	5.48	
Amps	12.5	15.1	15.0	15.0	16.8	16.8	16.7	16.7	18.6	18.6	18.5	18.5	20.2	20.2	20.2	20.2	21.8	21.8	21.7	21.7	21.8	21.8	21.7	21.7	
Hi PR	304	299	301	306	342	343	345	345	388	389	391	391	437	438	440	440	489	490	492	492	489	490	492	492	
Lo PR	120	124	132	132	122	128	136	136	124	130	139	139	125	132	140	140	126	133	141	141	126	133	141	141	
75	MBh	41.9	49.7	51.1	53.4	48.3	48.2	49.7	51.9	45.3	46.0	47.4	49.6	42.3	43.0	44.3	46.4	38.9	39.6	40.9	43.0	35.9	36.5	38.0	40.1
	S/T	0.68	0.61	0.48	0.34	0.67	0.62	0.49	0.35	0.72	0.65	0.52	0.38	0.74	0.67	0.54	0.40	0.77	0.69	0.56	0.42	0.82	0.75	0.62	0.48
	ΔT	28	25	21	17	28	24	21	17	26	24	20	17	25	23	20	16	24	22	19	15	26	24	20	17
	kW	2.24	3.70	3.70	3.74	3.37	4.10	4.09	4.13	4.53	4.53	4.52	4.55	4.97	4.96	4.95	4.99	5.43	5.43	5.42	5.46	5.43	5.43	5.42	5.46
	Amps	9.6	14.8	14.7	14.9	13.5	16.5	16.5	16.6	18.3	18.3	18.3	18.4	20.0	20.0	20.0	20.1	21.6	21.6	21.6	21.7	21.6	21.6	21.6	21.7
	Hi PR	281	293	295	300	343	337	339	345	382	383	385	390	431	432	434	439	483	485	487	492	483	485	487	492
	Lo PR	120	120	128	138	120	124	132	142	120	126	134	145	122	128	136	147	123	129	137	147	123	129	137	147
	MBh	47.3	50.4	51.9	54.1	48.3	49.0	50.4	52.6	46.1	46.7	48.1	49.6	43.0	43.7	45.1	47.2	39.6	40.3	41.6	43.7	36.6	37.2	38.6	40.1
	S/T	0.73	0.68	0.55	0.42	0.76	0.69	0.56	0.42	0.79	0.72	0.59	0.45	0.81	0.74	0.61	0.47	0.84	0.77	0.63	0.50	0.91	0.82	0.69	0.55
	ΔT	27	23	20	16	25	23	19	15	25	23	19	15	24	22	18	15	23	21	18	14	24	22	19	15
	kW	2.73	3.74	3.73	3.77	4.14	4.13	4.12	4.16	4.56	4.56	4.55	4.58	4.99	4.99	4.98	5.02	5.46	5.46	5.45	5.48	5.46	5.46	5.45	5.48
	Amps	11.2	14.9	14.9	15.1	16.7	16.6	16.6	16.8	18.5	18.4	18.4	18.6	20.1	20.1	20.1	20.2	21.7	21.7	21.7	21.8	21.7	21.7	21.7	21.8
Hi PR	293	296	298	303	339	340	342	348	385	386	388	393	434	435	437	442	486	488	490	494	486	488	490	494	
Lo PR	119	122	130	141	119	126	134	145	122	128	136	147	123	130	138	149	124	131	139	149	124	131	139	149	
MBh	51.5	51.4	52.8	55.1	49.2	49.9	51.3	53.5	47.0	47.6	49.1	51.2	43.9	44.6	46.0	48.1	40.5	41.1	42.5	44.5	37.5	38.1	39.5	41.0	
S/T	0.76	0.72	0.59	0.45	0.80	0.73	0.60	0.46	0.83	0.75	0.62	0.49	0.85	0.78	0.65	0.51	0.88	0.80	0.67	0.53	0.95	0.86	0.73	0.59	
ΔT	26	22	18	14	24	22	18	14	23	21	18	14	23	21	17	13	22	20	16	13	23	21	18	14	
kW	3.10	3.76	3.75	3.79	4.16	4.16	4.15	4.19	4.58	4.58	4.57	4.61	5.02	5.02	5.01	5.04	5.48	5.48	5.47	5.51	5.48	5.48	5.47	5.51	
Amps	12.5	15.0	15.0	15.2	16.8	16.7	16.7	16.9	18.6	18.5	18.5	18.7	20.2	20.2	20.2	20.3	21.8	21.8	21.7	21.9	21.8	21.8	21.7	21.9	
Hi PR	304	299	301	306	342	343	345	350	388	389	391	396	437	438	440	445	489	490	492	497	489	490	492	497	
Lo PR	120	124	132	143	122	128	136	147	124	130	139	150	125	132	140	151	126	133	141	152	126	133	141	152	

IDB = Entering Indoor Dry Bulb Temperature
 High and low pressures are measured at the liquid and suction service valves.
 Airflow may vary depending on actual ambient conditions and system operation modes.
 Shaded area is ACCA (TVA) conditions
 kW = Total system power
 Amps = outdoor unit amps (comp.+fan)

EXPANDED COOLING DATA — GXV6SS4810A* / AHVE48DP1300A* (CONT.)

IDB	AIRFLOW	OUTDOOR AMBIENT TEMPERATURE												ENTERING INDOOR WET BULB TEMPERATURE												
		65°F				75°F				85°F				95°F				105°F				115°F				
		59	63	67	71	59	63	67	71	59	63	67	71	59	63	67	71	59	63	67	71	59	63	67	71	
80	MBh	42.1	49.9	51.4	53.6	48.5	48.5	49.9	52.1	45.6	46.3	47.7	49.8	42.6	43.2	44.6	46.7	39.2	39.8	41.1	43.2	39.2	39.8	41.1	43.2	
	S/T	0.80	0.73	0.60	0.46	0.78	0.74	0.61	0.47	0.84	0.76	0.64	0.50	0.86	0.79	0.66	0.52	1.01	0.81	0.68	0.54	1.01	0.81	0.68	0.54	
	ΔT	33	29	26	22	33	29	25	21	30	28	25	21	29	28	24	20	29	27	23	20	30	28	24	21	
	kW	2.24	3.71	3.70	3.74	3.38	4.10	4.09	4.13	4.53	4.53	4.52	4.56	4.97	4.96	4.96	4.99	5.43	5.43	5.42	5.46	5.43	5.43	5.42	5.46	
	Amps	9.6	14.8	14.8	14.9	13.6	16.5	16.5	16.6	18.3	18.3	18.3	18.4	20.0	20.0	20.0	20.1	21.6	21.6	21.6	21.7	21.6	21.6	21.6	21.7	
	Hi PR	281	294	296	301	343	338	340	345	383	384	386	391	432	433	435	440	484	485	487	492	484	485	487	492	
	Lo PR	120	120	128	139	120	124	132	143	121	127	135	146	122	128	136	147	123	129	137	148	123	129	137	148	
	MBh	48.5	50.7	52.2	54.4	48.6	49.2	50.7	52.9	46.3	47.0	48.4	50.5	43.3	43.9	45.5	47.4	39.9	40.5	41.8	43.9	39.9	40.5	41.8	43.9	
	S/T	0.85	0.80	0.67	0.53	0.88	0.81	0.68	0.54	0.91	0.84	0.71	0.57	1.00	0.86	0.73	0.59	1.01	0.89	0.76	0.62	1.01	0.89	0.76	0.62	
	ΔT	32	28	24	20	29	27	24	20	29	27	23	20	28	26	23	19	27	25	22	18	28	26	23	19	
	kW	2.83	3.74	3.73	3.77	4.14	4.14	4.13	4.16	4.56	4.56	4.55	4.59	5.00	4.99	5.00	5.02	5.46	5.46	5.45	5.49	5.46	5.46	5.45	5.49	
	Amps	11.5	14.9	14.9	15.1	16.7	16.6	16.6	16.8	18.5	18.4	18.4	18.6	20.1	20.1	20.1	20.2	21.7	21.7	21.7	21.8	21.7	21.7	21.7	21.8	
Hi PR	296	297	299	304	340	341	343	348	386	387	389	394	434	436	437	443	487	488	490	495	487	488	490	495		
Lo PR	119	122	130	141	120	126	134	145	122	129	137	148	124	130	138	149	125	131	139	150	125	131	139	150		
1170	MBh	51.7	51.6	53.1	55.3	49.5	50.2	51.6	53.8	47.2	47.9	49.3	51.4	44.2	44.8	46.2	48.3	40.7	41.4	42.7	44.8	40.7	41.4	42.7	44.8	
	S/T	0.87	0.83	0.71	0.57	0.92	0.84	0.72	0.58	0.99	0.87	0.74	0.61	1.00	0.90	0.77	0.63	1.01	0.92	0.79	0.65	1.01	0.92	0.79	0.65	
	ΔT	31	27	23	19	28	26	22	18	28	26	22	18	27	25	21	18	26	24	21	17	27	25	22	18	
	kW	3.11	3.77	3.76	3.80	4.16	4.16	4.15	4.19	4.59	4.58	4.58	4.61	5.02	5.02	5.01	5.05	5.49	5.48	5.48	5.51	5.49	5.48	5.48	5.51	
	Amps	12.5	15.1	15.0	15.2	16.8	16.8	16.7	16.9	18.6	18.5	18.5	18.7	20.2	20.2	20.2	20.3	21.8	21.8	21.7	21.9	21.8	21.8	21.7	21.9	
	Hi PR	304	300	302	307	343	344	346	351	388	390	392	397	437	439	441	446	490	491	493	498	490	491	493	498	
	Lo PR	121	125	133	144	122	128	137	148	125	131	139	150	126	132	140	151	127	133	141	152	127	133	141	152	
	1590	MBh	48.5	50.8	52.2	54.5	48.6	49.3	50.7	52.9	46.4	47.0	48.5	50.6	43.3	44.0	45.4	47.5	39.9	40.6	41.9	44.0	39.9	40.6	41.9	44.0
		S/T	0.98	0.82	0.69	0.56	0.99	0.83	0.70	0.57	0.99	0.86	0.73	0.60	1.00	0.89	0.75	0.62	1.01	0.91	0.78	0.64	1.01	0.91	0.78	0.64
		ΔT	38	33	30	26	35	33	29	25	34	32	29	25	33	31	28	24	32	30	27	23	33	32	28	24
		kW	2.82	3.72	3.71	3.75	4.12	4.11	4.10	4.14	4.54	4.54	4.53	4.57	4.98	4.97	4.96	5.00	5.44	5.44	5.43	5.47	5.44	5.44	5.43	5.47
		Amps	11.4	14.8	14.8	15.0	16.6	16.5	16.5	16.7	18.4	18.4	18.3	18.5	20.1	20.1	20.0	20.2	21.6	21.6	21.6	21.7	21.6	21.6	21.6	21.7
Hi PR		295	295	297	302	338	339	341	346	384	385	387	392	433	434	436	441	485	486	488	493	485	486	488	493	
Lo PR		119	122	130	141	120	126	134	145	122	128	137	148	124	130	138	149	125	131	139	150	125	131	139	150	
85		MBh	51.6	51.5	53.0	55.2	49.4	50.0	51.5	53.7	47.1	47.8	49.2	51.3	44.0	44.7	46.1	48.2	40.6	41.3	42.6	44.7	40.6	41.3	42.6	44.7
		S/T	0.98	0.89	0.77	0.63	0.99	0.91	0.78	0.64	0.99	0.93	0.80	0.67	1.00	0.96	0.83	0.69	1.01	0.98	0.85	0.72	1.01	0.98	0.85	0.72
		ΔT	36	32	28	24	33	31	27	24	33	31	27	23	32	30	26	23	31	29	25	22	33	31	27	23
		kW	3.09	3.75	3.74	3.78	4.15	4.14	4.14	4.17	4.57	4.57	4.56	4.60	5.01	5.00	4.99	5.03	5.47	5.47	5.46	5.50	5.47	5.47	5.46	5.50
		Amps	12.4	15.0	14.9	15.1	16.7	16.7	16.7	16.8	18.5	18.5	18.4	18.6	20.2	20.2	20.1	20.3	21.7	21.7	21.7	21.8	21.7	21.7	21.7	21.8
	Hi PR	303	298	300	305	341	342	344	349	387	388	390	395	436	437	439	444	488	489	491	496	488	489	491	496	
	Lo PR	120	124	132	143	122	128	136	147	124	130	139	150	125	132	140	151	126	133	141	152	126	133	141	152	
	1380	MBh	51.8	52.5	53.9	56.2	50.3	51.0	52.4	54.6	48.0	48.7	50.1	52.2	44.9	45.6	47.0	49.1	41.5	42.1	43.5	45.5	41.5	42.1	43.5	45.5
		S/T	0.98	0.93	0.80	0.67	0.99	0.94	0.81	0.68	0.99	0.97	0.84	0.70	1.00	0.99	0.86	0.73	1.01	1.01	0.89	0.75	1.01	1.01	0.89	0.75
		ΔT	33	31	27	23	32	30	26	22	32	30	26	22	31	29	25	21	30	28	24	21	31	29	25	22
		kW	3.78	3.78	3.77	3.81	4.17	4.17	4.16	4.20	4.60	4.59	4.58	4.62	5.03	5.03	5.02	5.05	5.50	5.49	5.48	5.52	5.50	5.49	5.48	5.52
		Amps	15.1	15.1	15.1	15.2	16.8	16.8	16.8	16.9	18.6	18.6	18.6	18.7	20.3	20.3	20.2	20.4	21.8	21.8	21.8	21.9	21.8	21.8	21.8	21.9
Hi PR		300	301	303	308	344	345	347	352	390	391	393	398	439	440	442	447	491	492	494	499	491	492	494	499	
Lo PR		120	126	135	146	124	130	138	150	126	133	141	152	127	134	142	153	128	135	143	154	128	135	143	154	

IDB = Entering Indoor Dry Bulb Temperature
 High and low pressures are measured at the liquid and suction service valves.
 Airflow may vary depending on actual ambient conditions and system operation modes.
 Shaded areas is AHRI conditions.
 kW = Total system power
 Amps = outdoor unit amps (comp. fan)

EXPANDED COOLING DATA – GXV6SS6010A* / AHVE60DP1300A*

IDB	AIRFLOW	OUTDOOR AMBIENT TEMPERATURE																																			
		65°F				75°F				85°F				95°F				105°F				115°F															
		59	63	67	71	59	63	67	71	59	63	67	71	59	63	67	71	59	63	67	71	59	63	67	71												
70	MBh	29.1	42.9	59.2	39.7	56.1	57.8	47.4	53.7	55.4	49.6	50.4	52.0	42.2	42.9	44.3	33.3	33.8	35.1	29.1	42.9	59.2	39.7	56.1	57.8	47.4	53.7	55.4	49.6	50.4	52.0	42.2	42.9	44.3	33.3	33.8	35.1
	S/T	0.67	0.51	0.36	0.60	0.49	0.36	0.60	0.52	0.39	0.61	0.53	0.41	0.64	0.56	0.43	0.71	0.63	0.50	0.67	0.51	0.36	0.60	0.49	0.36	0.60	0.52	0.39	0.61	0.53	0.41	0.64	0.56	0.43	0.71	0.63	0.50
	ΔT	20	20	16	21	19	16	22	19	16	20	18	15	21	19	15	21	19	16	20	20	16	21	19	16	22	19	16	20	18	15	21	19	15	21	19	16
	kW	1.60	2.45	4.12	2.62	4.68	4.67	4.09	5.30	5.29	5.97	5.97	5.96	23.6	23.6	23.5	5.87	5.87	5.86	1.60	2.45	4.12	2.62	4.68	4.67	4.09	5.30	5.29	5.97	5.97	5.96	23.6	23.6	23.5	5.87	5.87	5.86
	Amps	6.5	9.9	16.3	10.6	18.6	18.6	16.2	21.2	21.1	24.0	24.0	23.9	483	485	487	5.09	5.09	5.08	6.5	9.9	16.3	10.6	18.6	18.6	16.2	21.2	21.1	24.0	24.0	23.9	483	485	487	5.09	5.09	5.08
	Hi PR	252	269	298	308	343	345	371	392	394	443	444	446	518	520	521	486	487	489	252	269	298	308	343	345	371	392	394	443	444	446	518	520	521	486	487	489
	Lo PR	121	120	122	119	120	128	119	124	133	121	128	137	133	141	150	126	134	141	121	120	122	119	120	128	119	124	133	121	128	137	133	141	150	126	134	141
	MBh	32.0	47.6	60.1	43.7	57.0	58.6	51.4	54.6	56.2	50.4	51.2	52.8	43.0	43.6	45.1	33.9	34.5	35.7	32.0	47.6	60.1	43.7	57.0	58.6	51.4	54.6	56.2	50.4	51.2	52.8	43.0	43.6	45.1	33.9	34.5	35.7
	S/T	0.73	0.58	0.43	0.66	0.56	0.43	0.67	0.59	0.46	0.68	0.61	0.48	0.71	0.64	0.51	0.78	0.71	0.57	0.73	0.58	0.43	0.66	0.56	0.43	0.67	0.59	0.46	0.68	0.61	0.48	0.71	0.64	0.51	0.78	0.71	0.57
	ΔT	19	19	14	20	18	14	21	18	14	19	17	14	19	18	14	20	18	14	19	19	14	20	18	14	21	18	14	19	17	14	20	18	14	20	18	14
	kW	1.73	2.80	4.15	2.95	4.72	4.71	4.56	5.34	5.33	6.01	6.00	5.99	23.7	23.7	23.7	5.90	5.90	5.89	1.73	2.80	4.15	2.95	4.72	4.71	4.56	5.34	5.33	6.01	6.00	5.99	23.7	23.7	23.7	5.90	5.90	5.89
	Amps	7.0	11.2	16.4	11.8	18.8	18.7	18.1	21.3	21.3	24.2	24.1	24.1	486	487	489	5.12	5.11	5.11	7.0	11.2	16.4	11.8	18.8	18.7	18.1	21.3	21.3	24.2	24.1	24.1	486	487	489	5.12	5.11	5.11
Hi PR	256	277	301	315	346	348	380	395	397	446	447	450	521	522	524	486	487	489	256	277	301	315	346	348	380	395	397	446	447	450	521	522	524	486	487	489	
Lo PR	121	120	124	119	122	130	119	126	135	122	130	139	126	134	143	126	134	143	121	120	124	119	122	130	119	126	135	122	130	139	126	134	143	126	134	143	
MBh	38.5	53.3	61.2	49.0	58.0	59.7	54.9	55.6	57.3	51.5	52.3	53.9	43.9	44.6	46.0	34.7	35.3	36.5	38.5	53.3	61.2	49.0	58.0	59.7	54.9	55.6	57.3	51.5	52.3	53.9	43.9	44.6	46.0	34.7	35.3	36.5	
S/T	0.72	0.60	0.46	0.69	0.60	0.47	0.69	0.62	0.49	0.71	0.64	0.51	0.75	0.67	0.54	0.82	0.74	0.61	0.72	0.60	0.46	0.69	0.60	0.47	0.69	0.62	0.49	0.71	0.64	0.51	0.75	0.67	0.54	0.82	0.74	0.61	
ΔT	19	18	13	19	17	13	18	17	13	18	16	12	18	16	13	19	17	13	19	18	13	19	17	13	18	17	13	18	16	13	19	17	13	19	17	13	
kW	2.10	3.26	4.18	3.42	4.75	4.74	5.37	5.37	5.36	6.04	6.03	6.02	23.8	23.8	23.8	5.93	5.92	5.91	2.10	3.26	4.18	3.42	4.75	4.74	5.37	5.37	5.36	6.04	6.03	6.02	23.8	23.8	23.8	5.93	5.92	5.91	
Amps	8.5	12.9	16.5	13.6	18.9	18.8	21.5	21.5	21.4	24.3	24.3	24.2	489	490	492	5.14	5.13	5.13	8.5	12.9	16.5	13.6	18.9	18.8	21.5	21.5	21.4	24.3	24.3	24.2	489	490	492	5.14	5.13	5.13	
Hi PR	266	287	304	326	349	351	396	398	400	449	450	452	524	525	527	489	490	492	266	287	304	326	349	351	396	398	400	449	450	452	524	525	527	489	490	492	
Lo PR	119	120	127	120	124	132	121	128	137	125	132	141	128	136	145	128	136	145	119	120	127	120	124	132	121	128	137	125	132	141	128	136	145	128	136	145	
75	MBh	29.1	42.9	59.3	39.8	56.1	57.8	47.5	53.7	55.4	49.6	50.4	52.0	42.2	42.9	44.4	33.3	33.9	35.1	29.1	42.9	59.3	39.8	56.1	57.8	47.5	53.7	55.4	49.6	50.4	52.0	42.2	42.9	44.4	33.3	33.9	35.1
	S/T	0.81	0.64	0.48	0.73	0.61	0.49	0.73	0.64	0.51	0.73	0.66	0.53	0.76	0.69	0.56	0.83	0.76	0.62	0.81	0.64	0.48	0.73	0.61	0.49	0.73	0.64	0.51	0.73	0.66	0.53	0.76	0.69	0.56	0.83	0.76	0.62
	ΔT	24	25	20	26	23	20	27	23	20	24	22	19	25	23	20	24	22	20	24	25	20	26	23	20	27	23	20	24	22	20	24	22	20	24	22	20
	kW	1.60	2.45	4.11	2.62	4.68	4.67	4.09	5.30	5.29	5.97	5.96	5.95	23.6	23.6	23.5	5.87	5.86	5.85	1.60	2.45	4.11	2.62	4.68	4.67	4.09	5.30	5.29	5.97	5.96	5.95	23.6	23.6	23.5	5.87	5.86	5.85
	Amps	6.5	9.9	16.2	10.6	18.6	18.5	16.2	21.2	21.1	24.0	24.0	23.9	484	485	487	5.09	5.09	5.08	6.5	9.9	16.2	10.6	18.6	18.5	16.2	21.2	21.1	24.0	24.0	23.9	484	485	487	5.09	5.09	5.08
	Hi PR	252	269	299	308	343	345	371	392	394	443	445	447	519	520	522	484	485	487	252	269	299	308	343	345	371	392	394	443	445	447	519	520	522	484	485	487
	Lo PR	121	120	122	119	120	128	119	124	133	121	128	137	133	141	150	126	134	141	121	120	122	119	120	128	119	124	133	121	128	137	133	141	150	126	134	141
	MBh	32.0	47.6	60.2	43.7	57.0	58.7	51.4	54.6	56.2	50.5	51.2	52.9	43.0	43.7	45.1	33.9	34.5	35.7	32.0	47.6	60.2	43.7	57.0	58.7	51.4	54.6	56.2	50.5	51.2	52.9	43.0	43.7	45.1	33.9	34.5	35.7
	S/T	0.87	0.71	0.55	0.79	0.68	0.56	0.79	0.71	0.58	0.79	0.73	0.60	0.80	0.73	0.63	0.83	0.76	0.62	0.87	0.71	0.55	0.79	0.68	0.56	0.79	0.71	0.58	0.79	0.73	0.60	0.80	0.73	0.63	0.83	0.76	0.62
	ΔT	23	23	19	25	22	18	25	22	18	21	19	15	23	21	18	24	22	19	23	23	19	25	22	18	25	22	18	21	19	15	23	21	18	24	22	19
	kW	1.73	2.79	4.15	2.95	4.72	4.71	4.55	5.33	5.32	6.00	6.00	5.99	23.7	23.7	23.6	5.90	5.89	5.89	1.73	2.79	4.15	2.95	4.72	4.71	4.55	5.33	5.32	6.00	6.00	5.99	23.7	23.7	23.6	5.90	5.89	5.89
	Amps	7.0	11.2	16.4	11.8	18.7	18.7	18.1	21.3	21.3	24.1	24.1	24.1	486	488	490	5.11	5.11	5.11	7.0	11.2	16.4	11.8	18.7	18.7	18.1	21.3	21.3	24.1	24.1	24.1	486	488	490	5.11	5.11	5.11
Hi PR	257	277	302	307	346	348	381	395	397	446	448	450	521	523	525	486	488	490	257	277	302	307	346	348	381	395	397	446	448	450	521	523	525	486	488	490	
Lo PR	121	120	124	120	122	130	121	126	135	122	130	139	126	134	143	126	134	143	121	120	124	120	122	130	121	126	135	122	130	139	126	134	143	126	134	143	
MBh	38.5	53.4	61.2	49.0	58.1	59.7	54.9	55.7	57.3	51.5	52.3	53.9	43.9	44.6	46.1	34.7	35.3	36.5	38.5	53.4	61.2	49.0	58.1	59.7	54.9	55.7	57.3	51.5	52.3	53.9	43.9	44.6	46.1	34.7	35.3	36.5	
S/T	0.86	0.73	0.59	0.82	0.72	0.59	0.82	0.74	0.62	0.83	0.76	0.63	0.83	0.76	0.63	0.83	0.76	0.62	0.86	0.73	0.59	0.82	0.72	0.59	0.82	0.74	0.62	0.83	0.76	0.63	0.83	0.76	0.63	0.83	0.76	0.62	
ΔT	23	22	18	24	21	17	23	21	17	22	20	17	23																								

EXPANDED COOLING DATA – GXV6SS6010A* / AHVE60DP1300A*(CONT.)

IDB	AIRFLOW	OUTDOOR AMBIENT TEMPERATURE												ENTERING INDOOR WET BULB TEMPERATURE											
		65°F				75°F				85°F				95°F				105°F				115°F			
		59	63	67	71	59	63	67	71	59	63	67	71	59	63	67	71	59	63	67	71	59	63	67	71
80	MBh	31.7	45.0	59.6	62.2	40.0	56.4	58.1	60.6	47.7	54.0	55.7	58.2	49.9	50.7	52.3	54.8	42.5	43.2	44.6	46.9	33.5	34.1	35.3	37.2
	S/T	0.92	0.76	0.60	0.46	0.85	0.73	0.60	0.47	0.84	0.76	0.63	0.49	0.85	0.77	0.65	0.51	1.00	0.81	0.68	0.54	1.00	0.88	0.75	0.61
	ΔT	29	29	25	21	30	28	24	20	31	27	24	20	28	27	23	20	30	28	24	20	29	27	24	20
	kW	1.72	2.60	4.12	4.16	2.62	4.68	4.67	4.72	4.09	5.30	5.29	5.33	5.97	5.97	5.96	6.00	5.87	5.86	5.86	5.89	5.09	5.09	5.08	5.11
	Amps	7.0	10.4	16.3	16.4	10.6	18.6	18.6	18.7	16.2	21.2	21.1	21.3	24.0	24.0	23.9	24.1	23.6	23.6	23.5	23.7	20.5	20.5	20.4	20.6
	Hi PR	254	272	299	304	309	344	346	351	372	393	395	400	444	445	447	452	484	485	487	492	519	520	522	527
	Lo PR	119	119	123	133	120	120	129	139	121	128	133	144	121	128	137	148	125	132	141	152	133	141	151	162
	MBh	34.0	50.3	60.4	63.0	43.9	57.3	59.0	61.5	54.1	54.9	56.5	59.0	50.8	51.5	53.5	55.6	43.2	43.9	45.4	47.6	34.1	34.7	35.9	37.8
	S/T	0.98	0.82	0.67	0.53	0.92	0.80	0.68	0.54	0.90	0.83	0.70	0.56	1.00	0.85	0.72	0.58	1.00	0.88	0.75	0.61	1.00	0.96	0.82	0.68
	ΔT	28	28	23	19	29	26	23	19	28	26	22	19	27	25	22	18	28	26	23	19	28	26	23	19
	kW	1.83	3.01	4.15	4.20	2.95	4.72	4.71	4.75	5.34	5.34	5.33	5.37	6.01	6.00	5.94	6.03	5.90	5.90	5.89	5.92	5.12	5.11	5.11	5.14
	Amps	7.5	12.0	16.4	16.6	11.8	18.8	18.7	18.9	21.4	21.3	21.3	21.5	24.2	24.1	24.0	24.3	23.7	23.7	23.7	23.8	20.6	20.6	20.5	20.7
Hi PR	259	281	302	307	316	347	349	354	394	396	398	403	447	448	447	455	487	488	490	495	522	523	525	530	
Lo PR	120	119	125	135	120	122	131	141	119	127	135	146	123	130	141	150	127	134	143	155	135	143	153	164	
MBh	40.1	57.2	61.5	64.1	51.6	58.4	60.0	62.6	55.2	55.9	57.6	60.1	51.8	52.6	54.2	56.6	44.2	44.9	46.3	48.6	34.9	35.5	36.7	38.6	
S/T	0.97	0.85	0.71	0.57	0.93	0.84	0.71	0.58	0.93	0.86	0.73	0.60	1.00	0.88	0.75	0.62	1.00	0.92	0.79	0.65	1.00	1.00	0.86	0.72	
ΔT	28	27	22	18	29	25	21	18	27	25	21	18	26	24	21	17	27	25	21	18	27	25	22	18	
kW	2.19	3.60	4.18	4.23	3.67	4.75	4.74	4.78	5.37	5.37	5.36	5.40	6.03	6.03	6.02	6.06	5.92	5.92	5.91	5.95	5.14	5.13	5.13	5.15	
Amps	8.9	14.2	16.5	16.7	14.6	18.9	18.8	19.0	21.5	21.5	21.4	21.6	24.3	24.3	24.2	24.4	23.8	23.8	23.8	23.9	20.7	20.6	20.6	20.7	
Hi PR	268	293	305	310	331	350	352	357	397	399	401	406	450	451	453	458	490	491	493	498	525	526	528	532	
Lo PR	119	119	127	138	119	124	133	144	122	129	138	149	125	133	142	153	129	137	146	157	137	145	155	167	
MBh	34.0	50.4	60.5	63.1	44.0	57.4	59.0	61.6	54.2	55.0	56.6	59.1	50.8	51.6	53.2	55.7	43.3	44.0	45.5	47.7	34.2	34.8	36.0	37.9	
S/T	1.00	0.85	0.69	0.56	1.00	0.83	0.70	0.56	1.00	0.85	0.72	0.59	1.00	0.87	0.74	0.61	1.00	0.91	0.78	0.64	1.00	1.00	0.85	0.71	
ΔT	33	34	28	25	34	31	28	24	33	31	28	24	32	30	27	23	33	31	28	24	33	31	28	24	
kW	1.82	2.99	4.13	4.17	2.93	4.69	4.68	4.73	5.32	5.31	5.30	5.34	5.98	5.98	5.97	6.01	5.88	5.87	5.87	5.90	5.10	5.10	5.09	5.12	
Amps	7.4	11.9	16.3	16.5	11.8	18.6	18.6	18.8	21.3	21.2	21.2	21.4	24.0	24.0	24.0	24.2	23.6	23.6	23.6	23.7	20.5	20.5	20.5	20.6	
Hi PR	258	280	301	306	314	345	347	352	393	394	396	401	445	447	449	454	485	487	489	494	520	522	523	528	
Lo PR	119	119	124	135	120	122	130	141	119	126	135	146	123	130	139	150	126	134	143	154	135	143	152	164	
MBh	38.6	53.5	61.4	64.0	49.2	58.2	59.9	62.4	55.0	55.8	57.5	60.0	51.7	52.4	54.0	56.5	44.1	44.7	46.2	48.4	34.8	35.4	36.6	38.5	
S/T	1.00	0.91	0.77	0.63	1.00	0.90	0.77	0.64	1.00	0.92	0.79	0.66	1.00	0.94	0.81	0.68	1.00	1.00	0.85	0.71	1.00	1.00	0.92	0.78	
ΔT	33	32	27	23	34	30	26	23	32	30	26	23	31	29	25	22	32	30	26	23	32	30	26	23	
kW	2.09	3.24	4.16	4.21	3.40	4.73	4.72	4.76	5.35	5.35	5.34	5.38	6.02	6.01	6.00	6.05	5.91	5.91	5.90	5.93	5.12	5.12	5.11	5.14	
Amps	8.5	12.8	16.5	16.6	13.5	18.8	18.8	18.9	21.4	21.4	21.3	21.5	24.2	24.2	24.1	24.3	23.7	23.7	23.7	23.9	20.6	20.6	20.6	20.7	
Hi PR	265	286	304	309	325	348	350	355	396	397	399	404	448	450	452	457	488	490	492	497	523	524	526	531	
Lo PR	119	120	127	137	120	124	132	143	121	128	137	148	124	132	141	152	128	136	145	156	137	145	154	166	
MBh	44.8	60.8	62.5	65.1	55.9	59.3	61.0	63.5	56.1	56.9	58.5	61.0	52.7	53.5	55.1	57.6	45.0	45.7	47.2	49.4	35.6	36.2	37.4	39.3	
S/T	1.00	0.93	0.80	0.67	1.00	0.93	0.81	0.67	1.00	0.96	0.83	0.70	1.00	0.98	0.85	0.71	1.00	1.00	0.89	0.75	1.00	1.00	0.96	0.82	
ΔT	32	30	26	22	33	29	25	22	30	29	25	21	30	28	24	21	31	29	25	21	30	29	25	22	
kW	2.50	4.20	4.19	4.24	4.07	4.76	4.75	4.79	5.38	5.38	5.37	5.41	6.05	6.04	6.03	6.07	5.93	5.93	5.92	5.96	5.14	5.14	5.13	5.16	
Amps	10.0	16.6	16.6	16.8	16.1	18.9	18.9	19.1	21.5	21.5	21.5	21.7	24.3	24.3	24.3	24.5	23.9	23.8	23.8	24.0	20.7	20.7	20.6	20.8	
Hi PR	275	304	306	312	338	351	353	358	399	400	402	407	451	453	455	460	491	492	494	499	526	527	529	534	
Lo PR	119	120	129	140	119	126	135	146	123	131	139	150	127	134	143	154	130	138	147	159	139	147	157	169	

IDB = Entering Indoor Dry Bulb Temperature
 High and low pressures are measured at the liquid and suction service valves.
 Airflow may vary depending on actual ambient conditions and system operation modes.
 Shaded areas is AHRI conditions.
 kW = Total system power
 Amps = outdoor unit amps (comp.+fan)

EXPANDED COOLING DATA – GXV6SA1810A* / AHVE24BP1300A* - SW

IDB	AIRFLOW	OUTDOOR AMBIENT TEMPERATURE												ENTERING INDOOR WET BULB TEMPERATURE											
		65°F				75°F				85°F				95°F				105°F				115°F			
		59	63	67	71	59	63	67	71	59	63	67	71	59	63	67	71	59	63	67	71	59	63	67	71
70	MBh	17.8	18.6	19.1	19.4	17.8	18.1	18.6	19.2	17.0	17.2	17.8	18.4	15.8	16.1	16.6	17.2	14.6	14.8	15.3	15.9	13.4	13.7	14.2	14.7
	S/T	0.62	0.52	0.38	0.46	0.60	0.52	0.38	0.46	0.62	0.54	0.41	0.48	0.63	0.56	0.42	0.50	0.65	0.58	0.44	0.52	0.70	0.63	0.49	0.57
	ΔT	22	18	14	14	19	17	14	14	19	17	14	14	18	16	13	13	17	16	13	12	18	16	14	12
	kW	0.85	0.93	0.93	0.93	1.08	1.07	1.07	1.08	1.24	1.24	1.24	1.25	1.43	1.43	1.43	1.43	1.64	1.64	1.64	1.65	1.89	1.89	1.89	1.90
	Amps	3.6	3.9	3.9	3.9	4.4	4.4	4.4	4.4	5.0	4.9	4.9	5.0	5.6	5.6	5.6	5.7	6.5	6.5	6.5	6.5	7.7	7.7	7.7	7.7
	Hi PR	234	237	238	238	277	278	279	282	321	322	323	326	369	370	371	374	421	423	424	427	479	480	482	484
	Lo PR	121	122	129	131	125	128	135	141	130	133	141	143	134	137	145	147	137	141	148	151	142	146	153	156
	MBh	18.6	18.9	19.4	19.4	18.1	18.3	18.9	19.2	17.2	17.5	18.0	18.4	16.1	16.4	16.9	17.2	14.8	15.1	15.6	15.9	13.7	13.9	14.4	14.7
	S/T	0.67	0.59	0.46	0.46	0.67	0.59	0.46	0.46	0.69	0.62	0.48	0.52	0.71	0.63	0.50	0.54	0.73	0.65	0.52	0.56	0.99	0.70	0.57	0.60
	ΔT	18	16	13	13	18	16	13	13	18	16	13	13	17	15	12	12	16	15	12	12	17	15	12	12
	kW	0.94	0.94	0.93	0.94	1.08	1.08	1.08	1.08	1.25	1.25	1.25	1.25	1.44	1.44	1.43	1.43	1.65	1.65	1.65	1.65	1.90	1.90	1.90	1.90
	Amps	3.9	3.9	3.9	3.9	4.4	4.4	4.4	4.4	5.0	5.0	5.0	5.0	5.7	5.7	5.7	5.7	6.6	6.5	6.5	6.5	7.7	7.7	7.7	7.7
Hi PR	238	239	241	241	279	280	282	284	323	324	326	326	371	372	374	376	424	425	427	427	481	482	484	484	
Lo PR	123	127	134	134	129	133	140	140	134	138	145	145	138	142	149	149	142	145	153	153	144	148	156	156	
MBh	17.8	18.6	19.1	19.4	17.8	18.1	18.6	19.2	17.0	17.2	17.8	18.4	15.9	16.1	16.6	17.2	14.6	14.8	15.3	15.9	13.4	13.7	14.2	14.7	
S/T	0.76	0.64	0.51	0.37	0.72	0.65	0.51	0.37	0.75	0.67	0.54	0.52	1.00	0.69	0.55	0.41	1.00	0.70	0.57	0.43	0.99	0.75	0.62	0.48	
ΔT	26	22	18	15	23	21	18	14	23	21	18	14	22	20	17	14	21	19	16	13	22	20	17	14	
kW	0.85	0.93	0.93	0.93	1.07	1.07	1.07	1.08	1.24	1.24	1.24	1.25	1.43	1.43	1.42	1.43	1.64	1.64	1.64	1.65	1.89	1.89	1.89	1.90	
Amps	3.6	3.9	3.9	3.9	4.4	4.4	4.4	4.4	4.9	4.9	4.9	5.0	5.6	5.6	5.6	5.7	6.5	6.5	6.5	6.5	7.7	7.7	7.7	7.7	
Hi PR	234	237	238	243	277	278	280	284	321	322	324	328	369	370	372	376	422	423	424	429	479	480	482	486	
Lo PR	121	122	129	141	125	128	135	147	130	133	141	153	134	137	145	157	137	141	148	161	142	146	154	166	
MBh	18.6	18.9	19.4	20.3	18.1	18.3	18.9	19.7	17.3	17.5	18.0	18.8	16.1	16.4	16.9	17.7	14.9	15.1	15.6	16.4	13.7	13.9	14.4	15.2	
S/T	0.80	0.72	0.58	0.44	0.80	0.72	0.59	0.45	0.82	0.75	0.61	0.47	1.00	0.76	0.63	0.49	1.00	0.78	0.65	0.50	0.99	0.83	0.69	0.55	
ΔT	22	20	17	14	22	20	17	13	21	20	16	13	21	19	16	13	20	18	15	12	20	19	16	13	
kW	0.94	0.93	0.93	0.94	1.08	1.08	1.08	1.09	1.25	1.25	1.25	1.26	1.44	1.44	1.43	1.44	1.65	1.65	1.65	1.66	1.90	1.90	1.90	1.91	
Amps	3.9	3.9	3.9	3.9	4.4	4.4	4.4	4.4	5.0	5.0	5.0	5.0	5.7	5.7	5.7	5.7	6.6	6.5	6.5	6.6	7.7	7.7	7.7	7.8	
Hi PR	238	239	241	245	279	280	282	286	323	324	326	330	371	372	374	379	424	425	427	431	482	483	484	489	
Lo PR	121	124	131	143	127	130	138	150	132	135	143	155	136	139	147	159	139	143	151	163	144	148	156	168	
MBh	19.0	19.2	19.8	20.6	18.4	18.7	19.2	20.0	17.6	17.8	18.4	19.2	16.5	16.7	17.2	18.0	15.2	15.4	15.9	16.7	14.0	14.3	14.8	15.5	
S/T	0.83	0.76	0.62	0.48	0.84	0.76	0.63	0.48	1.01	0.78	0.65	0.51	1.00	0.80	0.66	0.52	1.00	0.82	0.68	0.54	0.99	0.86	0.73	0.59	
ΔT	21	19	16	12	20	19	15	12	20	19	15	12	20	18	15	12	19	17	14	11	19	18	15	12	
kW	0.94	0.94	0.94	0.95	1.09	1.09	1.09	1.09	1.26	1.25	1.25	1.26	1.44	1.44	1.44	1.45	1.66	1.65	1.65	1.66	1.91	1.91	1.91	1.91	
Amps	3.9	3.9	3.9	4.0	4.4	4.4	4.4	4.4	5.0	5.0	5.0	5.0	5.7	5.7	5.7	5.7	6.6	6.6	6.6	6.6	7.8	7.8	7.8	7.8	
Hi PR	241	242	243	247	282	283	284	289	326	327	328	333	374	375	377	381	427	428	430	434	484	485	487	491	
Lo PR	123	127	134	146	129	133	140	152	134	138	145	157	138	142	149	161	142	145	153	165	147	150	158	171	

IDB = Entering Indoor Dry Bulb Temperature
 High and low pressures are measured at the liquid and suction service valves.
 Airflow may vary depending on actual ambient conditions and system operation modes.
 Shaded area is ACCA (TVA) conditions
 kW = Total system power
 Amps = outdoor unit amps (comp.+fan)

EXPANDED COOLING DATA – GXV6SA1810A* / AHVE24BP1300A* - SW (CONT.)

IDB	AIRFLOW	OUTDOOR AMBIENT TEMPERATURE												ENTERING INDOOR WET BULB TEMPERATURE											
		65°F				75°F				85°F				95°F				105°F				115°F			
		59	63	67	71	59	63	67	71	59	63	67	71	59	63	67	71	59	63	67	71	59	63	67	71
520	MBh	18.4	18.7	19.2	20.1	17.9	18.2	18.7	19.5	17.1	17.3	17.9	18.7	15.9	16.2	16.7	17.5	14.7	14.9	15.4	16.2	13.5	13.8	14.3	15.0
	S/T	0.85	0.77	0.63	0.49	1.01	0.79	0.66	0.52	1.00	0.81	0.68	0.53	1.00	0.83	0.69	0.55	1.00	0.83	0.69	0.55	0.99	0.99	0.74	0.60
	ΔT	27	26	22	19	27	25	22	18	26	25	21	18	25	24	21	17	25	23	20	17	25	23	21	17
	kW	0.93	0.93	0.93	0.93	1.07	1.07	1.07	1.08	1.24	1.24	1.24	1.25	1.43	1.43	1.43	1.43	1.64	1.64	1.64	1.65	1.89	1.89	1.89	1.90
	Amps	3.9	3.9	3.9	3.9	4.4	4.4	4.4	4.4	5.0	5.0	5.0	5.0	5.6	5.6	5.6	5.7	6.5	6.5	6.5	6.5	7.7	7.7	7.7	7.7
	Hi/PR	236	237	239	243	277	278	280	284	321	322	324	328	369	370	372	376	422	423	425	429	479	480	482	487
Lo/PR	119	123	130	141	125	129	136	148	130	134	141	153	134	138	145	157	138	141	149	161	143	146	154	166	
610	MBh	18.7	19.0	19.5	20.4	18.2	18.4	19.0	19.8	17.3	17.6	18.1	18.9	16.2	16.5	17.1	17.8	14.9	15.2	15.7	16.5	13.8	14.0	14.5	15.3
	S/T	0.92	0.85	0.71	0.57	1.01	0.87	0.73	0.59	1.00	0.88	0.75	0.61	1.00	0.90	0.77	0.63	1.00	0.90	0.77	0.63	0.99	0.99	0.82	0.68
	ΔT	26	24	21	17	25	24	20	17	24	23	20	17	24	23	20	16	23	22	19	16	24	22	19	16
	kW	0.94	0.94	0.93	0.94	1.08	1.08	1.08	1.09	1.25	1.25	1.25	1.26	1.44	1.44	1.44	1.44	1.65	1.65	1.65	1.66	1.90	1.90	1.90	1.91
	Amps	3.9	3.9	3.9	4.0	4.4	4.4	4.4	4.4	5.0	5.0	5.0	5.0	5.7	5.7	5.7	5.7	6.6	6.5	6.5	6.6	7.7	7.7	7.7	7.8
	Hi/PR	239	240	241	245	280	281	282	287	324	325	326	331	372	373	375	379	425	426	428	432	482	483	485	489
Lo/PR	121	125	132	144	127	131	138	150	132	136	143	155	136	140	144	150	140	144	151	163	145	148	156	169	
700	MBh	19.1	19.3	19.9	20.7	18.5	18.8	19.3	20.1	17.7	17.9	18.5	19.3	16.5	16.8	17.3	18.1	15.3	15.5	16.0	16.8	14.1	14.3	14.8	15.6
	S/T	1.01	0.88	0.75	0.61	1.01	0.89	0.75	0.61	1.01	0.91	0.77	0.63	1.00	0.92	0.79	0.65	1.00	1.00	0.81	0.67	0.99	0.99	0.85	0.71
	ΔT	25	23	20	16	24	23	19	16	24	22	19	16	23	22	18	15	22	21	18	15	23	21	18	15
	kW	0.94	0.94	0.94	0.95	1.09	1.09	1.09	1.10	1.26	1.26	1.25	1.26	1.44	1.44	1.44	1.45	1.66	1.65	1.65	1.66	1.91	1.91	1.91	1.92
	Amps	4.0	3.9	3.9	4.0	4.4	4.4	4.4	4.4	5.0	5.0	5.0	5.0	5.7	5.7	5.7	5.7	6.6	6.6	6.6	6.6	7.8	7.8	7.8	7.8
	Hi/PR	241	242	244	248	282	283	285	289	326	327	329	333	374	375	377	381	427	428	430	434	484	486	487	492
Lo/PR	124	127	134	146	130	133	141	153	135	138	146	158	139	142	150	162	142	146	153	166	147	151	158	171	
520	MBh	18.7	19.0	19.5	20.4	18.2	18.5	19.0	19.8	17.4	17.6	18.1	19.0	16.2	16.5	17.0	17.8	15.0	15.2	15.7	16.5	13.8	14.0	14.5	15.3
	S/T	1.01	0.87	0.74	0.59	1.01	0.87	0.74	0.60	1.01	1.01	0.76	0.62	1.00	1.00	0.78	0.63	1.00	1.00	0.79	0.65	0.99	0.99	0.84	0.70
	ΔT	31	29	26	22	30	28	25	22	30	28	25	21	29	27	24	21	28	26	23	20	28	27	24	21
	kW	0.93	0.93	0.93	0.94	1.08	1.08	1.07	1.08	1.24	1.24	1.24	1.25	1.43	1.43	1.43	1.44	1.64	1.64	1.64	1.65	1.90	1.89	1.89	1.90
	Amps	3.9	3.9	3.9	3.9	4.4	4.4	4.4	4.4	5.0	5.0	4.9	5.0	5.6	5.6	5.6	5.7	6.5	6.5	6.5	6.6	7.7	7.7	7.7	7.7
	Hi/PR	237	238	240	244	278	279	281	285	322	323	325	329	371	372	373	378	423	424	426	430	481	482	483	488
Lo/PR	121	125	132	143	127	131	138	150	132	136	143	155	136	140	147	159	140	143	151	163	144	148	156	168	
610	MBh	19.0	19.3	19.8	20.7	18.5	18.7	19.3	20.1	17.6	17.9	18.4	19.2	16.5	16.7	17.3	18.1	15.2	15.5	16.0	16.7	14.1	14.3	14.8	15.5
	S/T	1.01	0.95	0.81	0.67	1.01	0.95	0.81	0.67	1.01	1.01	0.84	0.69	1.00	1.00	0.85	0.71	1.00	1.00	0.87	0.73	0.99	0.99	0.92	0.78
	ΔT	29	28	24	21	29	27	24	20	28	27	23	20	27	26	23	20	27	25	22	19	27	25	22	19
	kW	0.94	0.94	0.94	0.94	1.08	1.08	1.08	1.09	1.25	1.25	1.25	1.26	1.44	1.44	1.44	1.45	1.65	1.65	1.65	1.66	1.90	1.90	1.90	1.91
	Amps	3.9	3.9	3.9	4.0	4.4	4.4	4.4	4.4	5.0	5.0	5.0	5.0	5.7	5.7	5.7	5.7	6.6	6.6	6.6	6.6	7.8	7.8	7.7	7.8
	Hi/PR	240	241	242	247	281	282	284	288	325	326	328	332	373	374	376	380	426	427	429	433	483	484	486	490
Lo/PR	123	127	134	146	129	133	140	152	134	138	145	157	138	142	149	161	142	145	153	165	146	150	158	171	
700	MBh	19.4	19.6	20.2	21.0	18.8	19.1	19.6	20.4	18.0	18.2	18.8	19.6	16.8	17.1	17.6	18.4	15.6	15.8	16.3	17.1	14.4	14.6	15.1	15.9
	S/T	1.01	0.99	0.85	0.71	1.01	0.99	0.85	0.71	1.01	1.01	0.87	0.73	1.00	1.00	0.89	0.75	1.00	1.00	0.91	0.77	0.99	0.99	0.99	0.81
	ΔT	28	27	23	20	28	26	23	19	27	26	22	19	26	25	22	19	26	24	21	18	26	24	21	18
	kW	0.94	0.94	0.94	0.95	1.09	1.09	1.09	1.10	1.26	1.26	1.26	1.27	1.45	1.44	1.44	1.45	1.66	1.66	1.66	1.66	1.91	1.91	1.91	1.92
	Amps	4.0	4.0	3.9	4.0	4.4	4.4	4.4	4.5	5.0	5.0	5.0	5.0	5.7	5.7	5.7	5.7	6.6	6.6	6.6	6.6	7.8	7.8	7.8	7.8
	Hi/PR	242	243	245	249	283	284	286	290	327	328	330	334	375	377	378	383	428	429	431	435	486	487	489	493
Lo/PR	126	129	136	148	132	135	142	155	136	140	148	160	140	144	152	164	144	148	155	168	149	152	160	173	

IDB = Entering Indoor Dry Bulb Temperature
 High and low pressures are measured at the liquid and suction service valves.
 Airflow may vary depending on actual ambient conditions and system operation modes.
 Shaded areas is AHRI conditions.
 kW = Total system power
 Amps = outdoor unit amps (comp.+fan)

EXPANDED COOLING DATA – GXV6SA2410A* / AHVE24BP1300A* - SW

IDB	AIRFLOW	OUTDOOR AMBIENT TEMPERATURE																													
		65°F					75°F					85°F					95°F					105°F					115°F				
		59	63	67	71	75	59	63	67	71	75	59	63	67	71	75	59	63	67	71	75	59	63	67	71	75	59	63	67	71	75
70	MBh	20.3	25.6	26.3	27.5	24.4	24.7	25.5	26.6	23.1	23.5	24.2	24.5	21.5	21.8	22.5	23.1	23.5	24.2	24.5	19.7	20.0	20.7	21.0	18.0	18.3	19.0				
	S/T	0.63	0.51	0.37	0.38	0.59	0.51	0.38	0.36	0.61	0.53	0.40	0.40	0.63	0.55	0.42	0.48	0.48	0.40	0.40	0.64	0.57	0.44	0.51	0.69	0.62	0.49				
	ΔT	22	19	15	15	20	18	15	15	20	18	15	15	19	17	14	13	13	13	15	18	16	13	12	19	17	14				
	kW	1.09	1.57	1.56	1.58	1.78	1.78	1.78	1.79	2.02	2.02	2.01	2.01	2.28	2.27	2.27	2.28	2.28	2.01	2.01	2.57	2.56	2.56	2.57	2.91	2.90	2.90				
	Amps	4.4	6.0	6.0	6.1	6.8	6.8	6.8	6.9	7.9	7.9	7.8	7.8	8.9	8.9	8.9	8.9	8.9	7.8	7.8	10.0	10.0	10.0	10.0	10.1	10.2	10.2				
	Hi PR	243	261	263	267	303	304	306	306	349	350	352	352	399	401	402	402	402	352	352	454	455	457	460	513	514	516				
	Lo PR	120	119	126	138	121	125	135	144	126	130	138	140	130	134	141	141	140	138	138	133	137	145	145	138	142	150				
	MBh	23.2	26.0	26.7	28.4	24.8	25.1	25.8	26.3	24.0	24.3	25.0	25.0	21.8	22.2	22.9	23.3	23.3	24.6	24.6	20.0	20.3	21.0	21.4	18.3	18.7	19.3				
	S/T	0.69	0.58	0.45	0.44	0.66	0.59	0.45	0.49	0.72	0.65	0.51	0.51	0.70	0.66	0.53	0.53	0.51	0.48	0.48	0.72	0.64	0.51	0.55	0.76	0.69	0.56				
	ΔT	21	17	14	14	19	17	13	13	17	15	12	12	18	16	13	12	12	13	13	17	15	12	11	17	16	13				
kW	1.28	1.58	1.58	1.59	1.79	1.79	1.79	1.80	2.04	2.04	2.04	2.04	2.29	2.29	2.29	2.29	2.29	2.04	2.04	2.58	2.58	2.57	2.57	2.92	2.92	2.91					
Amps	5.0	6.0	6.0	6.1	6.9	6.9	6.9	6.9	7.9	7.9	7.9	7.9	9.1	9.0	9.0	9.0	9.0	7.9	7.9	10.0	10.0	10.0	10.0	10.1	10.1	10.1					
Hi PR	251	263	265	268	306	307	309	309	352	353	355	355	399	403	405	405	405	355	355	457	458	460	460	516	517	519					
Lo PR	120	121	129	131	123	127	135	144	126	132	140	140	130	136	144	144	140	138	138	135	139	147	147	140	144	152					
MBh	26.1	26.5	27.2	28.4	25.2	25.6	26.3	26.3	24.0	24.3	25.0	25.0	22.3	22.6	23.3	23.3	23.3	25.0	25.0	20.4	20.8	21.4	21.4	18.8	19.1	19.7					
S/T	0.70	0.62	0.49	0.49	0.70	0.62	0.49	0.49	0.72	0.65	0.51	0.51	0.74	0.66	0.53	0.53	0.51	0.51	0.51	0.75	0.68	0.55	0.55	0.80	0.73	0.60					
ΔT	18	16	13	13	17	16	12	12	17	15	12	12	16	15	12	12	12	12	12	16	14	11	11	16	15	12					
kW	1.59	1.59	1.59	1.59	1.80	1.80	1.80	1.80	2.04	2.04	2.04	2.04	2.30	2.30	2.29	2.29	2.29	2.04	2.04	2.59	2.59	2.58	2.58	2.93	2.93	2.92					
Amps	6.1	6.1	6.1	6.1	6.9	6.9	6.9	6.9	7.9	7.9	7.9	7.9	9.1	9.0	9.0	9.0	9.0	7.9	7.9	10.0	10.0	10.0	10.0	10.1	10.1	10.1					
Hi PR	265	266	268	273	308	310	311	311	355	356	358	358	405	406	408	408	408	358	358	459	461	463	463	518	520	522					
Lo PR	119	124	131	142	125	129	137	149	130	134	142	142	134	138	146	146	142	142	137	142	142	150	150	142	146	154					

75	MBh	20.3	25.6	26.3	27.5	24.4	24.7	25.5	26.6	23.1	23.5	24.2	24.5	21.5	21.8	22.5	23.1	23.5	24.2	24.5	19.7	20.0	20.7	21.0	18.0	18.3	19.0
	S/T	0.77	0.64	0.50	0.36	0.71	0.64	0.51	0.36	0.74	0.66	0.53	0.39	0.75	0.68	0.54	0.41	0.46	0.46	0.61	0.77	0.70	0.56	0.42	0.99	0.74	0.61
	ΔT	26	23	19	16	24	22	19	15	24	22	18	15	23	21	18	14	14	14	14	22	20	17	14	22	20	17
	kW	1.09	1.57	1.56	1.58	1.78	1.78	1.77	1.79	2.02	2.01	2.01	2.03	2.27	2.27	2.27	2.29	2.29	2.03	2.03	2.56	2.56	2.56	2.57	2.90	2.90	2.91
	Amps	4.4	6.0	6.0	6.0	6.8	6.8	6.8	6.8	7.8	7.8	7.8	7.9	8.9	8.9	8.9	8.9	8.9	7.8	7.8	10.0	10.0	10.0	10.0	10.2	10.2	10.1
	Hi PR	244	261	263	267	303	304	306	311	349	351	352	357	400	401	403	407	407	357	357	454	455	457	462	513	514	516
	Lo PR	120	119	126	138	121	125	133	144	126	130	138	149	130	134	142	153	149	138	138	133	138	145	157	138	142	150
	MBh	23.2	26.0	26.7	27.9	24.8	25.1	25.9	27.0	23.5	23.9	24.6	25.7	21.9	22.2	22.9	24.0	24.0	24.6	24.6	20.0	20.3	21.0	22.1	18.4	18.7	19.3
	S/T	0.83	0.71	0.58	0.44	0.79	0.71	0.58	0.44	0.81	0.73	0.60	0.46	0.82	0.75	0.62	0.48	0.46	0.46	0.61	0.77	0.77	0.64	0.50	0.99	0.82	0.68
	ΔT	25	21	18	14	23	21	17	14	22	20	17	14	21	20	16	13	13	13	13	20	19	16	12	21	19	16
kW	1.28	1.58	1.58	1.59	1.79	1.79	1.79	1.80	2.03	2.03	2.02	2.04	2.29	2.29	2.28	2.30	2.30	2.04	2.04	2.58	2.58	2.57	2.59	2.92	2.92	2.91	
Amps	5.0	6.0	6.0	6.1	6.9	6.8	6.8	6.9	7.9	7.9	7.8	7.9	9.0	9.0	9.0	9.0	9.0	7.9	7.9	10.0	10.0	10.0	10.0	10.1	10.1	10.1	
Hi PR	251	264	265	270	306	307	309	314	352	353	355	360	402	403	405	410	410	360	360	457	458	460	465	516	517	519	
Lo PR	120	121	129	140	123	127	135	146	128	132	140	151	132	136	144	155	151	140	140	135	140	147	159	140	144	152	
MBh	26.1	26.5	27.2	28.4	25.2	25.6	26.3	27.5	24.0	24.3	25.0	26.1	22.3	22.6	23.3	24.4	24.4	25.0	25.0	20.5	20.8	21.5	22.5	18.8	19.1	19.8	
S/T	0.82	0.75	0.61	0.47	0.83	0.75	0.62	0.48	0.85	0.77	0.64	0.50	1.00	0.79	0.66	0.52	0.50	0.50	0.61	0.81	0.81	0.67	0.54	0.99	0.85	0.72	
ΔT	22	20	17	13	21	20	16	13	21	19	16	13	20	19	15	12	12	13	13	19	18	15	11	20	18	15	
kW	1.59	1.59	1.59	1.60	1.80	1.80	1.80	1.81	2.04	2.04	2.04	2.05	2.30	2.30	2.29	2.31	2.31	2.05	2.05	2.59	2.59	2.58	2.60	2.93	2.93	2.94	
Amps	6.1	6.1	6.1	6.1	6.9	6.9	6.9	7.0	7.9	7.9	7.9	8.0	9.0	9.0	9.0	9.1	9.1	8.0	8.0	10.0	10.0	10.0	10.1	10.1	10.1	10.1	
Hi PR	265	266	268	273	309	310	312	316	355	356	358	362	405	406	408	413	413	362	362	460	461	463	467	519	520	522	
Lo PR	119	124	131	142	125	129	137	149	130	134	142	154	134	138	146	158	154	142	142	137	142	150	162	142	147	154	

IDB = Entering Indoor Dry Bulb Temperature
 High and low pressures are measured at the liquid and suction service valves.
 Airflow may vary depending on actual ambient conditions and system operation modes.
 Shaded area is ACCA (TVA) conditions
 kW = Total system power
 Amps = outdoor unit amps (comp.+fan)

EXPANDED COOLING DATA – GXV6SA2410A* / AHVE24BP1300A* - SW (CONT.)

IDB	AIRFLOW	OUTDOOR AMBIENT TEMPERATURE												ENTERING INDOOR WET BULB TEMPERATURE												
		65°F				75°F				85°F				95°F				105°F				115°F				
		59	63	67	71	59	63	67	71	59	63	67	71	59	63	67	71	59	63	67	71	59	63	67	71	
80	MBh	21.9	25.7	26.5	27.6	24.5	24.9	25.6	26.7	23.3	23.6	24.3	25.4	21.6	21.9	22.6	23.7	19.8	20.1	20.8	21.8	18.1	18.4	19.1	20.1	
	S/T	0.89	0.76	0.63	0.48	0.84	0.76	0.63	0.49	1.01	0.78	0.65	0.51	1.00	0.80	0.67	0.53	1.00	0.82	0.69	0.55	0.99	0.86	0.73	0.59	
	ΔT	31	27	23	20	28	26	23	19	27	26	22	19	26	25	21	18	25	24	21	17	26	24	21	18	
	kW	1.19	1.57	1.56	1.58	1.78	1.78	1.78	1.79	2.02	2.02	2.01	2.03	2.28	2.27	2.27	2.29	2.56	2.56	2.56	2.58	2.90	2.90	2.90	2.92	
	Amps	4.7	6.0	6.0	6.0	6.8	6.8	6.8	6.9	7.8	7.8	7.8	7.9	8.9	8.9	8.9	9.0	10.0	10.0	10.0	10.0	10.2	10.2	10.2	10.1	
	Hi PR	247	261	263	268	304	305	307	311	350	351	353	358	400	401	403	408	455	456	456	462	514	515	517	522	
	Lo PR	120	120	127	138	121	126	133	144	126	131	138	158	130	134	142	154	134	138	146	158	138	143	151	163	
	MBh	25.2	26.1	26.9	28.0	24.9	25.2	26.0	27.1	23.6	24.0	24.7	25.8	22.0	22.3	23.2	24.1	20.1	20.5	21.1	22.2	18.5	18.8	19.4	20.5	
	S/T	0.95	0.83	0.70	0.56	1.01	0.84	0.70	0.56	1.01	0.86	0.72	0.58	1.00	0.87	0.74	0.60	1.00	0.89	0.76	0.62	0.99	0.94	0.81	0.67	
	ΔT	30	25	22	18	27	25	21	18	26	24	21	18	25	23	20	17	24	23	19	16	25	23	20	17	
kW	1.42	1.58	1.58	1.59	1.79	1.79	1.79	1.80	2.03	2.03	2.03	2.04	2.29	2.29	2.29	2.30	2.58	2.58	2.57	2.59	2.92	2.92	2.91	2.93		
Amps	5.5	6.0	6.0	6.1	6.9	6.9	6.8	6.9	7.9	7.9	7.9	8.0	9.0	9.0	9.0	9.1	10.0	10.0	10.0	10.0	10.1	10.1	10.1	10.1		
Hi PR	255	264	266	270	306	308	309	314	353	354	356	360	403	404	407	411	458	459	461	465	517	518	520	524		
Lo PR	119	122	129	140	123	128	135	147	128	133	140	152	132	136	146	156	136	140	148	160	140	145	153	165		
920	MBh	26.2	26.6	27.4	28.5	25.4	25.7	26.5	27.6	24.1	24.4	25.2	26.3	22.4	22.8	23.5	24.5	20.6	20.9	21.6	22.6	18.9	19.2	19.9	20.9	
	S/T	0.95	0.87	0.74	0.60	1.01	0.87	0.74	0.60	1.01	0.89	0.76	0.62	1.00	0.91	0.78	0.64	1.00	0.93	0.80	0.66	0.99	0.99	0.84	0.70	
	ΔT	26	24	21	17	25	24	20	17	25	23	20	17	24	22	19	16	23	22	18	15	24	22	19	16	
	kW	1.59	1.59	1.59	1.60	1.80	1.80	1.80	1.81	2.04	2.04	2.04	2.05	2.30	2.30	2.29	2.31	2.59	2.59	2.58	2.60	2.93	2.93	2.92	2.94	
	Amps	6.1	6.1	6.1	6.1	6.9	6.9	6.9	7.0	7.9	7.9	7.9	8.0	9.1	9.0	9.0	9.1	10.0	10.0	10.0	10.1	10.1	10.1	10.1	10.1	
	Hi PR	266	267	269	273	309	310	312	317	355	356	358	363	405	407	408	413	460	461	463	468	519	520	522	527	
	Lo PR	120	124	131	143	126	130	138	149	130	135	143	154	134	139	146	158	138	142	150	162	142	147	155	167	
	680	MBh	23.4	26.1	26.9	28.1	24.9	25.3	26.0	27.1	23.7	24.0	24.7	25.8	22.0	22.3	23.0	24.1	20.2	20.5	21.2	22.2	18.5	18.8	19.5	20.5
		S/T	1.01	0.86	0.73	0.58	1.01	0.86	0.73	0.59	1.01	0.88	0.75	0.61	1.00	1.00	0.77	0.63	1.00	1.00	0.78	0.65	0.99	0.99	0.83	0.69
		ΔT	35	31	27	23	31	30	26	23	31	29	26	22	30	28	25	22	29	27	24	21	29	27	24	21
kW		1.27	1.57	1.57	1.58	1.78	1.78	1.78	1.79	2.02	2.02	2.02	2.03	2.28	2.28	2.27	2.29	2.57	2.57	2.56	2.58	2.91	2.91	2.90	2.92	
Amps		5.0	6.0	6.0	6.0	6.8	6.8	6.8	6.9	7.8	7.8	7.8	7.9	9.0	9.0	8.9	9.0	10.0	10.0	10.0	10.0	10.1	10.1	10.1	10.1	
Hi PR		250	263	265	269	305	306	308	313	351	352	354	359	401	402	404	409	456	457	459	464	515	516	518	523	
Lo PR		120	121	129	140	123	127	135	146	128	132	140	152	132	136	144	156	135	140	148	159	140	144	152	164	
MBh		26.2	26.5	27.3	28.4	25.3	25.7	26.4	27.5	24.0	24.4	25.1	26.2	22.4	22.7	23.4	24.5	20.5	20.8	21.5	22.6	18.8	19.2	19.8	20.8	
S/T		1.01	0.93	0.80	0.66	1.01	0.94	0.80	0.66	1.01	0.96	0.82	0.68	1.00	1.00	0.84	0.70	1.00	1.00	0.86	0.72	0.99	0.99	0.90	0.77	
ΔT		31	29	26	22	30	28	25	21	30	28	25	21	29	27	24	20	27	26	23	19	28	26	23	20	
kW	1.59	1.58	1.58	1.60	1.80	1.80	1.79	1.81	2.03	2.03	2.03	2.05	2.29	2.29	2.29	2.30	2.58	2.58	2.58	2.59	2.92	2.92	2.92	2.93		
Amps	6.1	6.1	6.0	6.1	6.9	6.9	6.9	6.9	7.9	7.9	7.9	8.0	9.0	9.0	9.0	9.1	10.0	10.0	10.0	10.0	10.1	10.1	10.1	10.1		
Hi PR	264	265	267	272	308	309	311	315	354	355	357	361	404	405	407	412	459	460	462	467	518	519	521	526		
Lo PR	119	124	131	142	125	129	137	149	130	134	142	154	134	138	146	158	137	142	150	162	142	146	154	167		
85	MBh	26.7	27.0	27.8	28.9	25.8	26.1	26.9	28.0	24.5	24.8	25.6	26.7	22.8	23.2	23.9	24.9	21.0	21.3	22.0	23.0	19.3	19.6	20.3	21.3	
	S/T	1.01	0.97	0.84	0.70	1.01	0.97	0.84	0.70	1.01	1.01	0.86	0.72	1.00	1.00	0.88	0.74	1.00	1.00	0.89	0.76	0.99	0.99	0.94	0.80	
	ΔT	30	28	25	21	29	27	24	20	29	27	23	20	27	26	23	19	26	25	22	18	27	25	22	19	
	kW	1.60	1.59	1.59	1.61	1.81	1.81	1.80	1.82	2.05	2.04	2.04	2.06	2.30	2.30	2.30	2.31	2.59	2.59	2.59	2.60	2.93	2.93	2.93	2.94	
	Amps	6.1	6.1	6.1	6.1	6.9	6.9	6.9	7.0	7.9	7.9	7.9	8.0	9.1	9.1	9.0	9.1	10.0	10.0	10.0	10.1	10.1	10.1	10.1	10.1	
	Hi PR	267	268	270	274	310	311	313	318	356	358	359	364	407	408	410	414	461	463	464	469	520	522	524	528	
	Lo PR	122	126	133	145	127	132	139	151	132	137	144	156	136	140	148	160	139	144	152	164	144	149	157	169	

IDB = Entering Indoor Dry Bulb Temperature
 High and low pressures are measured at the liquid and suction service valves.
 Airflow may vary depending on actual ambient conditions and system operation modes.
 Shaded areas is AHRI conditions.
 kW = Total system power
 Amps = outdoor unit amps (comp.+fan)

EXPANDED COOLING DATA – GXV6SA3010A* / AHVE36CP1300A* – SW

IDB	AIRFLOW	OUTDOOR AMBIENT TEMPERATURE												ENTERING INDOOR WET BULB TEMPERATURE											
		65°F				75°F				85°F				95°F				105°F				115°F			
		59	63	67	71	59	63	67	71	59	63	67	71	59	63	67	71	59	63	67	71	59	63	67	71
70	MBh	31.0	31.3	32.2	32.2	29.8	30.3	31.2	31.2	28.3	28.7	29.6	29.6	26.3	26.7	27.5	27.5	24.0	24.4	25.3	25.3	22.0	22.4	23.2	23.2
	S/T	0.60	0.52	0.38	0.39	0.60	0.52	0.39	0.41	0.63	0.55	0.41	0.41	0.65	0.57	0.44	0.44	0.68	0.60	0.46	0.46	0.73	0.66	0.52	0.52
	ΔT	22	18	15	14	20	18	14	14	19	17	14	14	19	17	14	14	18	16	13	13	18	17	14	14
	kW	1.82	2.03	2.02	2.27	2.27	2.27	2.27	2.54	2.54	2.54	2.54	2.54	2.83	2.83	2.83	2.83	3.15	3.15	3.15	3.15	3.53	3.52	3.52	3.52
	Amps	6.7	7.6	7.5	8.6	8.6	8.6	8.6	9.8	9.8	9.8	9.8	9.8	11.0	11.0	11.0	11.0	12.4	12.4	12.4	12.4	13.9	13.9	13.9	13.9
	Hi PR	274	275	277	320	317	318	320	365	362	364	365	365	411	412	414	414	464	465	467	467	520	521	523	523
	Lo PR	119	120	126	133	123	126	133	138	127	131	138	138	131	135	142	142	135	138	145	145	140	143	150	150
	MBh	31.5	31.8	32.7	31.6	30.3	30.7	31.6	31.6	28.8	29.2	30.1	30.1	26.7	27.1	28.0	28.0	24.5	24.9	25.7	25.7	22.4	22.8	23.6	23.6
	S/T	0.68	0.59	0.46	0.46	0.68	0.60	0.46	0.46	0.71	0.63	0.49	0.49	0.73	0.65	0.51	0.51	0.76	0.68	0.54	0.54	0.81	0.73	0.59	0.59
	ΔT	21	17	13	13	18	16	13	13	18	16	13	13	17	16	12	12	17	15	12	12	17	16	13	13
	kW	1.84	2.04	2.04	2.28	2.29	2.29	2.28	2.55	2.56	2.56	2.55	2.55	2.85	2.85	2.84	2.84	3.17	3.17	3.16	3.16	3.54	3.54	3.54	3.54
	Amps	6.8	7.6	7.6	8.7	8.7	8.7	8.7	9.9	9.9	9.9	9.8	9.8	11.1	11.1	11.1	11.1	12.5	12.4	12.4	12.4	14.0	14.0	14.0	14.0
Hi PR	277	278	280	323	320	321	323	368	365	366	368	368	414	415	417	417	467	468	470	470	523	524	526	526	
Lo PR	121	122	129	135	125	128	135	140	129	133	140	140	133	137	144	144	137	140	147	147	142	145	152	152	
MBh	32.0	32.4	33.3	32.2	30.9	31.3	32.2	32.2	29.3	29.7	30.6	30.6	27.3	27.7	28.5	28.5	25.0	25.4	26.2	26.2	23.0	23.3	24.2	24.2	
S/T	0.71	0.63	0.49	0.50	0.72	0.64	0.50	0.50	0.74	0.67	0.53	0.53	0.77	0.69	0.55	0.55	0.79	0.72	0.58	0.58	1.01	0.77	0.63	0.63	
ΔT	18	16	12	12	17	15	12	12	17	15	12	12	16	15	11	11	16	14	11	11	16	15	12	12	
kW	2.06	2.06	2.05	2.30	2.30	2.30	2.30	2.57	2.57	2.57	2.57	2.57	2.86	2.86	2.86	2.86	3.18	3.18	3.18	3.18	3.55	3.55	3.55	3.55	
Amps	7.7	7.7	7.7	8.7	8.8	8.7	8.7	9.9	9.9	9.9	9.9	9.9	11.2	11.1	11.1	11.1	12.5	12.5	12.5	12.5	14.1	14.1	14.0	14.0	
Hi PR	279	280	282	326	323	324	326	371	368	369	371	371	417	418	420	420	469	471	472	472	526	527	529	529	
Lo PR	121	124	131	137	127	130	137	142	132	135	142	142	136	139	146	146	139	143	150	150	144	147	155	155	

860	MBh	31.0	31.3	32.3	33.7	29.9	30.3	31.2	32.6	28.3	28.7	29.6	31.0	26.3	26.7	27.6	28.9	24.1	24.5	25.3	26.6	22.0	22.4	23.2	24.5
	S/T	0.73	0.64	0.51	0.37	0.73	0.65	0.52	0.37	0.76	0.68	0.55	0.40	0.78	0.71	0.57	0.42	1.01	0.73	0.59	0.45	1.01	0.79	0.65	0.50
	ΔT	27	22	19	15	24	22	18	15	23	21	18	15	22	21	17	14	21	20	17	14	22	20	17	14
	kW	1.82	2.03	2.02	2.04	2.27	2.27	2.27	2.29	2.54	2.54	2.54	2.56	2.83	2.83	2.83	2.84	3.15	3.15	3.14	3.16	3.52	3.52	3.52	3.54
	Amps	6.7	7.5	7.5	7.6	8.6	8.6	8.6	8.7	9.8	9.8	9.8	9.8	11.0	11.0	11.0	11.1	12.4	12.4	12.4	12.4	13.9	13.9	13.9	14.0
	Hi PR	274	275	277	282	317	318	320	325	363	364	366	370	411	413	415	419	464	465	467	472	520	521	523	528
	Lo PR	119	120	127	138	123	126	133	144	127	131	138	149	131	135	142	153	135	138	145	157	140	143	150	162
	MBh	31.5	31.8	32.7	34.2	30.3	30.8	31.7	33.0	28.8	29.2	30.1	31.4	26.7	27.1	28.0	29.3	24.5	24.9	25.7	27.0	22.5	22.8	23.6	24.9
	S/T	0.81	0.72	0.58	0.44	0.81	0.73	0.59	0.45	0.84	0.76	0.62	0.48	1.00	0.78	0.64	0.50	1.01	0.81	0.67	0.52	1.01	0.87	0.73	0.58
	ΔT	25	21	18	14	22	20	17	14	22	20	17	13	21	19	16	13	20	19	15	12	21	19	16	13
	kW	1.84	2.04	2.04	2.06	2.29	2.29	2.28	2.30	2.56	2.56	2.55	2.57	2.85	2.85	2.84	2.86	3.17	3.17	3.16	3.18	3.54	3.54	3.53	3.55
	Amps	6.8	7.6	7.6	7.7	8.7	8.7	8.7	8.7	9.9	9.8	9.8	9.9	11.1	11.1	11.1	11.1	12.4	12.4	12.4	12.5	14.0	14.0	14.0	14.1
Hi PR	277	278	280	285	320	321	323	328	365	367	368	373	414	415	417	422	467	468	470	475	523	524	526	531	
Lo PR	121	122	129	140	125	128	135	146	130	133	140	151	133	137	144	155	137	140	147	159	142	145	152	164	
MBh	32.0	32.4	33.3	34.8	30.9	31.3	32.2	33.6	29.4	29.8	30.6	32.0	27.3	27.7	28.6	29.9	25.0	25.4	26.3	27.5	23.0	23.4	24.2	25.4	
S/T	0.83	0.76	0.62	0.48	0.85	0.77	0.63	0.49	0.87	0.80	0.66	0.52	1.00	0.82	0.68	0.54	1.01	0.85	0.71	0.56	1.01	0.90	0.77	0.62	
ΔT	22	20	16	13	21	19	16	12	21	19	16	12	20	18	15	12	19	18	14	11	20	18	15	12	
kW	2.06	2.06	2.05	2.07	2.30	2.30	2.30	2.32	2.57	2.57	2.57	2.59	2.86	2.86	2.85	2.87	3.18	3.18	3.17	3.19	3.55	3.55	3.55	3.57	
Amps	7.7	7.7	7.7	7.7	8.7	8.7	8.7	8.8	9.9	9.9	9.9	10.0	11.1	11.1	11.1	11.2	12.5	12.5	12.5	12.6	14.1	14.0	14.0	14.1	
Hi PR	279	281	283	287	323	324	326	331	368	369	371	376	417	418	420	425	470	471	473	477	526	527	529	534	
Lo PR	121	124	131	142	127	130	137	149	132	135	142	154	136	139	146	158	139	143	150	162	144	147	155	167	

IDB = Entering Indoor Dry Bulb Temperature
 High and low pressures are measured at the liquid and suction service valves.
 Airflow may vary depending on actual ambient conditions and system operation modes.
 Shaded area is ACCA (TVA) conditions
 kW = Total system power
 Amps = outdoor unit amps (comp.+fan)

EXPANDED COOLING DATA – GXV6SA3010A* / AHVE36CP1300A* – SW (CONT.)

IDB	AIRFLOW	OUTDOOR AMBIENT TEMPERATURE												ENTERING INDOOR WET BULB TEMPERATURE												
		65°F				75°F				85°F				95°F				105°F				115°F				
		59	63	67	71	59	63	67	71	59	63	67	71	59	63	67	71	59	63	67	71	59	63	67	71	
80	MBh	31.2	31.5	32.4	33.8	30.0	30.4	31.3	32.7	28.5	28.9	29.8	31.1	26.4	26.9	27.7	29.0	24.2	24.6	25.4	26.7	22.2	22.6	23.4	24.6	
	S/T	0.86	0.77	0.63	0.49	0.99	0.78	0.64	0.50	1.00	0.81	0.67	0.53	1.00	0.83	0.70	0.55	1.01	0.86	0.72	0.58	1.01	0.92	0.78	0.63	
	ΔT	31	26	23	19	27	26	22	19	27	25	22	19	26	24	21	18	25	23	20	17	25	24	21	18	
	kW	1.82	2.03	2.02	2.04	2.27	2.27	2.27	2.29	2.54	2.54	2.54	2.56	2.83	2.83	2.83	2.85	3.15	3.15	3.15	3.17	3.53	3.52	3.52	3.54	
	Amps	6.7	7.6	7.5	7.6	8.6	8.6	8.6	8.7	9.8	9.8	9.8	9.8	11.0	11.0	11.0	11.1	12.4	12.4	12.4	12.4	13.9	13.9	13.9	14.0	
	Hi PR	274	276	278	282	318	319	321	326	363	364	366	371	412	413	415	420	465	466	466	472	521	522	524	529	
	Lo PR	120	120	120	127	138	123	126	133	144	128	131	138	150	132	135	142	154	135	139	146	158	140	144	151	163
	MBh	31.5	32.0	32.9	34.3	30.5	30.9	31.8	33.2	28.9	29.4	30.2	31.6	26.9	27.3	28.4	29.5	24.6	25.0	25.9	27.1	22.6	23.0	23.8	25.0	
	S/T	0.92	0.85	0.71	0.57	0.99	0.86	0.72	0.58	1.00	0.89	0.75	0.60	1.00	0.91	0.77	0.63	1.01	0.94	0.80	0.65	1.01	1.01	0.86	0.71	
	ΔT	27	25	22	18	26	24	21	18	26	24	21	17	25	23	20	17	24	22	19	16	24	23	20	17	
kW	2.05	2.04	2.04	2.06	2.29	2.29	2.28	2.30	2.56	2.56	2.55	2.57	2.85	2.85	2.84	2.86	3.17	3.17	3.16	3.18	3.54	3.54	3.53	3.55		
Amps	7.6	7.6	7.6	7.7	8.7	8.7	8.7	8.8	9.9	9.9	9.8	9.9	11.1	11.1	11.1	11.2	12.5	12.4	12.4	12.5	14.0	14.0	14.0	14.1		
Hi PR	277	278	280	285	321	322	324	328	366	367	369	374	415	416	416	423	467	469	470	475	524	525	527	531		
Lo PR	119	122	129	140	125	128	135	147	130	133	140	152	134	137	146	156	137	141	148	160	142	146	153	165		
MBh	32.1	32.6	33.5	34.9	31.1	31.5	32.4	33.8	29.5	29.9	30.8	32.1	27.4	27.8	28.7	30.0	25.2	25.6	26.4	27.7	23.1	23.5	24.3	25.5		
S/T	0.96	0.88	0.75	0.61	0.99	0.89	0.76	0.61	1.00	0.92	0.79	0.64	1.00	0.95	0.81	0.67	1.01	0.98	0.84	0.69	1.01	1.01	0.89	0.75		
ΔT	26	24	20	17	25	23	20	16	25	23	20	16	24	22	19	16	23	21	18	15	23	22	19	16		
kW	2.06	2.06	2.05	2.07	2.30	2.30	2.30	2.32	2.57	2.57	2.57	2.59	2.86	2.86	2.86	2.88	3.18	3.18	3.18	3.19	3.55	3.55	3.55	3.57		
Amps	7.7	7.7	7.7	7.8	8.8	8.7	8.7	8.8	9.9	9.9	9.9	10.0	11.2	11.1	11.1	11.2	12.5	12.5	12.5	12.6	14.1	14.1	14.0	14.1		
Hi PR	280	281	283	288	323	324	326	331	369	370	372	376	417	419	421	425	470	471	473	478	526	527	529	534		
Lo PR	122	125	132	143	127	131	138	149	132	136	143	154	136	139	147	158	140	143	150	162	144	148	155	167		
85	MBh	31.7	32.0	32.9	34.4	30.5	31.0	31.9	33.2	29.0	29.4	30.3	31.6	26.9	27.3	28.2	29.5	24.7	25.1	25.9	27.2	22.6	23.0	23.8	25.1	
	S/T	0.99	0.87	0.74	0.59	0.99	0.88	0.75	0.60	1.00	0.91	0.78	0.63	1.00	1.00	0.80	0.65	1.01	1.01	0.82	0.68	1.01	1.01	0.88	0.73	
	ΔT	35	30	27	23	31	29	26	22	30	29	25	22	29	28	25	21	28	27	24	20	29	27	24	21	
	kW	1.83	2.03	2.03	2.05	2.28	2.28	2.27	2.29	2.55	2.55	2.54	2.56	2.84	2.84	2.83	2.85	3.16	3.16	3.15	3.17	3.53	3.53	3.52	3.54	
	Amps	6.8	7.6	7.6	7.6	8.6	8.6	8.6	8.7	9.8	9.8	9.8	9.9	11.1	11.0	11.0	11.1	12.4	12.4	12.4	12.5	14.0	14.0	13.9	14.0	
	Hi PR	276	277	279	284	319	320	322	327	364	366	367	372	413	414	416	421	466	467	469	474	522	523	525	530	
	Lo PR	122	122	129	140	125	128	135	146	130	133	140	151	134	137	144	156	137	141	148	159	142	145	153	164	
	MBh	32.1	32.5	33.4	34.8	31.0	31.4	32.3	33.7	29.4	29.8	30.7	32.1	27.4	27.8	28.6	29.9	25.1	25.5	26.3	27.6	23.1	23.4	24.2	25.5	
	S/T	0.99	0.95	0.81	0.67	0.99	0.96	0.82	0.68	1.00	0.99	0.85	0.71	1.00	1.00	0.88	0.73	1.01	1.01	0.90	0.76	1.01	1.01	0.96	0.81	
	ΔT	30	29	25	22	30	28	25	21	29	27	24	21	28	26	23	20	27	25	22	19	27	26	23	20	
kW	2.05	2.05	2.04	2.06	2.30	2.29	2.29	2.31	2.57	2.56	2.56	2.58	2.85	2.85	2.85	2.87	3.17	3.17	3.17	3.19	3.55	3.54	3.54	3.56		
Amps	7.7	7.6	7.6	7.7	8.7	8.7	8.7	8.8	9.9	9.9	9.9	9.9	11.1	11.1	11.1	11.2	12.5	12.5	12.4	12.5	14.0	14.0	14.0	14.1		
Hi PR	279	280	282	286	322	323	325	330	367	368	370	375	416	417	419	424	469	470	472	477	525	526	528	533		
Lo PR	121	124	131	142	127	130	137	149	132	135	142	154	136	139	146	158	139	143	150	162	144	147	155	167		
MBh	32.7	33.1	34.0	35.4	31.6	32.0	32.9	34.3	30.0	30.4	31.3	32.6	27.9	28.3	29.2	30.5	25.6	26.0	26.9	28.1	23.6	24.0	24.8	26.0		
S/T	0.99	0.99	0.85	0.71	0.99	0.99	0.86	0.72	1.00	1.00	0.89	0.75	1.00	1.00	0.91	0.77	1.01	1.01	0.94	0.79	1.01	1.01	1.00	0.85		
ΔT	29	28	24	21	29	27	23	20	28	26	23	20	27	25	22	19	26	24	21	18	26	25	22	19		
kW	2.06	2.06	2.06	2.08	2.31	2.31	2.30	2.32	2.58	2.58	2.57	2.59	2.87	2.87	2.86	2.88	3.19	3.18	3.18	3.20	3.56	3.56	3.55	3.57		
Amps	7.7	7.7	7.7	7.8	8.8	8.8	8.7	8.8	9.9	9.9	9.9	10.0	11.2	11.2	11.1	11.2	12.5	12.5	12.5	12.6	14.1	14.1	14.1	14.1		
Hi PR	281	282	284	289	325	326	328	332	370	371	373	378	419	420	422	427	471	473	475	479	528	529	531	535		
Lo PR	123	127	133	145	129	132	139	151	134	137	144	156	138	141	148	160	141	145	152	164	146	150	157	169		

IDB = Entering Indoor Dry Bulb Temperature
 High and low pressures are measured at the liquid and suction service valves.
 Airflow may vary depending on actual ambient conditions and system operation modes.
 Shaded areas is AHRI conditions.
 kW = Total system power
 Amps = outdoor unit amps (comp. + fan)

EXPANDED COOLING DATA – GXV6SA3610A* / CAPEA3626*3A* + MBVK16CP1***A* - SW

IDB	AIRFLOW	OUTDOOR AMBIENT TEMPERATURE												ENTERING INDOOR WET BULB TEMPERATURE																					
		65°F				75°F				85°F				95°F				105°F				115°F													
		59	63	67	71	59	63	67	71	59	63	67	71	59	63	67	71	59	63	67	71	59	63	67	71										
70	MBh	29.0	32.6	37.0	34.4	34.9	36.0	32.8	33.3	34.3	30.6	31.1	32.0	28.1	28.6	29.5	26.7	27.1	28.1	0.66	0.55	0.39	0.62	0.54	0.40	0.66	0.58	0.44	0.68	0.61	0.47	1.00	0.66	0.52	
	S/T	20	19	14	19	17	14	19	17	14	18	16	13	17	15	12	18	16	13	1.56	1.77	2.31	2.64	2.64	2.63	3.00	2.99	2.99	3.82	3.82	3.81	4.38	4.38	4.37	
	kW	5.7	6.5	8.6	10.0	10.0	9.9	11.5	11.5	11.4	13.1	13.1	13.1	14.9	14.9	14.9	17.2	17.2	17.1	283	288	292	330	331	333	416	417	419	462	463	465	510	512	513	
	Amps	120	120	124	124	126	132	131	133	139	139	139	146	143	145	152	150	152	159	32.7	36.5	37.6	35.0	35.5	36.5	31.1	31.6	32.6	28.6	29.1	30.0	27.2	27.6	28.6	
	Hi/PR	0.72	0.61	0.47	0.70	0.62	0.48	0.72	0.64	0.50	0.74	0.66	0.52	1.00	0.68	0.54	1.00	0.74	0.60	19	16	13	18	16	13	17	15	12	16	15	12	17	15	12	
	Lo/PR	1.78	2.34	2.33	2.66	2.66	2.65	3.01	3.01	3.01	3.40	3.40	3.40	3.84	3.84	3.83	4.40	4.40	4.39	6.6	8.7	8.7	10.1	10.0	10.0	11.6	11.6	11.5	15.0	15.0	15.0	17.2	17.2	17.2	
	Amps	289	293	295	333	334	336	375	376	378	419	420	422	465	466	468	513	514	516	120	120	126	126	128	134	139	141	148	145	147	154	152	155	162	
	Hi/PR	36.7	37.2	38.3	35.6	36.1	37.2	34.0	34.5	35.5	31.7	32.2	33.2	29.2	29.7	30.7	27.8	28.3	29.3	0.73	0.65	0.51	0.74	0.66	0.52	0.78	0.70	0.56	1.00	0.72	0.58	1.00	0.77	0.63	
	Lo/PR	17	15	12	17	15	12	16	15	12	16	14	11	15	14	11	16	14	11	2.36	2.35	2.35	2.67	2.67	2.67	3.03	3.03	3.02	3.85	3.85	3.85	4.42	4.41	4.41	
	Amps	8.8	8.8	8.7	10.1	10.1	10.1	11.6	11.6	11.6	13.3	13.2	13.2	15.1	15.0	15.0	17.3	17.3	17.3	295	296	298	336	337	339	421	423	425	468	469	471	516	517	519	
	Hi/PR	121	123	129	128	130	137	135	137	144	141	143	150	147	150	156	155	157	164	121	123	129	128	130	137	141	143	150	147	150	156	155	157	164	
	Lo/PR	29.1	32.6	37.1	34.4	34.9	36.0	32.8	33.3	34.3	30.6	31.1	32.1	28.1	28.6	29.6	26.7	27.1	28.1	0.80	0.69	0.53	0.75	0.68	0.53	0.78	0.70	0.58	1.00	0.74	0.60	1.00	0.79	0.65	
75	MBh	24	23	18	23	21	18	22	21	18	22	20	17	21	19	16	21	20	17	1.56	1.77	2.31	2.64	2.63	2.63	3.03	2.99	2.99	3.82	3.81	3.83	4.38	4.38	4.39	
	S/T	5.7	6.5	8.6	10.0	10.0	9.9	11.5	11.5	11.4	13.1	13.1	13.1	14.9	14.9	14.9	17.2	17.1	17.1	283	288	293	330	331	333	416	417	419	462	464	465	511	512	514	
	kW	8.8	8.7	8.7	10.1	10.1	10.1	11.6	11.6	11.6	13.3	13.2	13.2	15.1	15.0	15.0	17.3	17.3	17.3	120	120	124	124	126	132	139	141	148	145	147	154	152	155	162	
	Amps	32.7	36.6	37.6	35.0	35.5	36.5	31.1	31.6	32.6	28.6	29.1	30.1	27.2	27.6	28.6	30.1	31.5	30.1	0.85	0.75	0.61	0.83	0.75	0.61	0.86	0.78	0.64	1.00	0.82	0.68	1.00	0.82	0.68	
	Hi/PR	17	15	12	17	15	12	16	15	12	16	14	11	15	14	11	16	14	11	24	20	17	21	20	16	20	18	15	20	18	15	20	19	16	13
	Lo/PR	2.36	2.35	2.35	2.67	2.67	2.67	3.03	3.03	3.02	3.85	3.85	3.85	4.42	4.41	4.41	5.16	5.17	5.19	289	293	295	333	334	336	419	420	422	465	466	468	513	515	516	521
	Amps	120	120	126	126	128	134	133	135	142	141	143	150	147	150	156	155	157	164	36.7	37.2	38.3	35.0	35.5	36.5	31.1	31.6	32.6	28.6	29.1	30.0	27.2	27.6	28.6	
	Hi/PR	0.72	0.61	0.47	0.70	0.62	0.48	0.72	0.64	0.50	0.74	0.66	0.52	1.00	0.68	0.54	1.00	0.74	0.60	19	16	13	18	16	13	17	15	12	16	15	12	17	15	12	
	Lo/PR	1.78	2.34	2.33	2.66	2.66	2.65	3.01	3.01	3.01	3.40	3.40	3.40	3.84	3.84	3.83	4.40	4.40	4.39	6.6	8.7	8.7	10.1	10.0	10.0	11.6	11.6	11.5	15.0	15.0	15.0	17.2	17.2	17.2	
	Amps	289	293	295	333	334	336	375	376	378	419	420	422	465	466	468	513	514	516	120	120	126	126	128	134	139	141	148	145	147	154	152	155	162	
	Hi/PR	36.7	37.2	38.3	35.0	35.5	36.5	31.1	31.6	32.6	28.6	29.1	30.1	27.2	27.6	28.6	30.1	31.5	30.1	0.87	0.79	0.65	0.87	0.79	0.65	0.86	0.78	0.64	1.00	0.82	0.68	1.00	0.82	0.68	
	Lo/PR	17	15	12	17	15	12	16	15	12	16	14	11	15	14	11	16	14	11	24	20	17	21	20	16	20	18	15	20	18	15	20	19	16	13
Amps	2.36	2.35	2.35	2.67	2.67	2.67	3.03	3.03	3.02	3.85	3.85	3.85	4.42	4.41	4.41	5.16	5.17	5.19	289	293	295	333	334	336	419	420	422	465	466	468	513	515	516	521	
Hi/PR	120	120	126	126	128	134	133	135	142	141	143	150	147	150	156	155	157	164	36.7	37.2	38.3	35.0	35.5	36.5	31.1	31.6	32.6	28.6	29.1	30.0	27.2	27.6	28.6		
Lo/PR	0.72	0.61	0.47	0.70	0.62	0.48	0.72	0.64	0.50	0.74	0.66	0.52	1.00	0.68	0.54	1.00	0.74	0.60	19	16	13	18	16	13	17	15	12	16	15	12	17	15	12		
Amps	1.78	2.34	2.33	2.66	2.66	2.65	3.01	3.01	3.01	3.40	3.40	3.40	3.84	3.84	3.83	4.40	4.40	4.39	6.6	8.7	8.7	10.1	10.0	10.0	11.6	11.6	11.5	15.0	15.0	15.0	17.2	17.2	17.2		
Hi/PR	289	293	295	333	334	336	375	376	378	419	420	422	465	466	468	513	514	516	120	120	126	126	128	134	139	141	148	145	147	154	152	155	162		
Lo/PR	36.7	37.2	38.3	35.0	35.5	36.5	31.1	31.6	32.6	28.6	29.1	30.1	27.2	27.6	28.6	30.1	31.5	30.1	0.87	0.79	0.65	0.87	0.79	0.65	0.86	0.78	0.64	1.00	0.82	0.68	1.00	0.82	0.68		
Amps	17	15	12	17	15	12	16	15	12	16	14	11	15	14	11	16	14	11	24	20	17	21	20	16	20	18	15	20	18	15	20	19	16	13	
Hi/PR	2.36	2.35	2.35	2.67	2.67	2.67	3.03	3.03	3.02	3.85	3.85	3.85	4.42	4.41	4.41	5.16	5.17	5.19	289	293	295	333	334	336	419	420	422	465	466	468	513	515	516	521	
Lo/PR	289	293	295	333	334	336	375	376	378	419	420	422	465	466	468	513	514	516	120	120	126	126	128	134	139	141	148	145	147	154	152	155	162		
Hi/PR	36.7	37.2	38.3	35.0	35.5	36.5	31.1	31.6	32.6	28.6	29.1	30.1	27.2	27.6	28.6	30.1	31.5	30.1	0.87	0.79	0.65	0.87	0.79	0.65	0.86	0.78	0.64	1.00	0.82	0.68	1.00	0.82	0.68		
Lo/PR	17	15	12	17	15	12	16	15	12	16	14	11	15	14	11	16	14	11	24	20	17	21	20	16	20	18	15	20	18	15	20	19	16	13	
Amps	2.36	2.35	2.35	2.67	2.67	2.67	3.03	3.03	3.02	3.85	3.85	3.85	4.42	4.41	4.41	5.16	5.17	5.19	289	293	295	333	334	336	419	420	422	465	466	468	513	515	516	521	
Hi/PR	120	120	126	126	128	134	133	135	142	141	143	150	147	150	156	155	157	164	36.7	37.2	38.3	35.0	35.5	36.5	31.1	31.6	32.6	28.6	29.1	30.0	27.2	27.6	28.6		
Lo/PR	0.72	0.61	0.47	0.70	0.62	0.48	0.72	0.64	0.50	0.74	0.66	0.52	1.00	0.68	0.54	1.00	0.74	0.60	19	16	13	18	16	13	17	15	12	16	15	12	17	15	12		
Amps	1.78	2.34	2.33	2.66	2.66	2.65	3.01	3.01	3.01	3.40	3.40	3.40	3.84	3.84	3.83	4.40	4.40	4.39	6.6	8.7	8.7	10.1	10.0	10.0	11.6	11.6	11.5	15.0	15.0	15.0	17.2	17.2	17.2		
Hi/PR	289	293	295	333	334	336	375	376	378	419	420	422	465	466	468	513	514	516	120	120	126	126	128	134	139	141	148	145	147	154	152	155	162		
Lo/PR	36.7	37.2	38.3	35.0	35.5	36.5	31.1	31.6	32.6	28.6	29.1	30.1	27.2	27.6	28.6	30.1	31.5	30.1	0.87																

EXPANDED COOLING DATA – GXV6SA3610A* / CAPEA3626*3A* + MBVK16CP1***A* - SW (CONT.)

IDB	AIRFLOW	OUTDOOR AMBIENT TEMPERATURE												ENTERING INDOOR WET BULB TEMPERATURE												
		65°F				75°F				85°F				95°F				105°F				115°F				
		59	63	67	71	59	63	67	71	59	63	67	71	59	63	67	71	59	63	67	71	59	63	67	71	
80	MBh	30.6	32.8	37.3	38.9	34.6	35.1	36.2	37.7	33.0	33.5	34.5	36.0	30.8	31.2	32.2	33.8	28.3	28.8	29.7	31.2	26.9	27.3	28.3	29.8	
	S/T	0.92	0.83	0.66	0.51	1.01	0.81	0.66	0.52	1.00	0.83	0.69	0.54	1.00	0.85	0.71	0.56	1.00	1.00	0.73	0.58	1.00	1.00	0.78	0.63	
	ΔT	29	27	22	19	26	25	22	18	26	24	21	18	25	24	21	17	25	23	20	17	25	23	20	17	
	kW	1.65	1.77	2.31	2.34	2.64	2.64	2.63	2.65	2.99	2.99	2.99	3.01	3.38	3.38	3.38	3.40	3.82	3.82	3.81	3.83	4.38	4.38	4.37	4.40	
	Amps	6.1	6.5	8.6	8.7	10.0	10.0	9.9	10.0	11.5	11.5	11.4	11.5	13.1	13.1	13.1	13.2	14.9	14.9	14.9	15.0	17.2	17.2	17.1	17.2	
	Hi PR	285	288	293	298	331	332	334	339	373	374	376	381	417	418	420	425	463	464	466	471	511	512	514	519	
	Lo PR	120	120	125	136	125	127	133	144	131	134	140	152	137	140	146	158	143	146	152	165	151	153	160	173	
	MBh	32.9	36.7	37.8	39.4	35.2	35.7	36.7	38.3	33.5	34.0	35.0	36.6	31.3	31.8	33.0	34.3	28.8	29.3	30.2	31.7	27.4	27.8	28.8	30.3	
	S/T	0.99	0.88	0.74	0.59	1.01	0.88	0.74	0.59	1.00	0.91	0.77	0.62	1.00	0.93	0.79	0.64	1.00	1.00	0.81	0.66	1.00	1.00	0.86	0.71	
	ΔT	28	24	21	17	25	23	20	17	25	23	20	17	24	22	19	16	23	22	19	16	24	22	19	16	
kW	1.78	2.34	2.33	2.36	2.66	2.66	2.65	2.67	3.01	3.01	3.01	3.03	3.40	3.40	3.37	3.42	3.84	3.84	3.83	3.85	4.40	4.40	4.39	4.42		
Amps	6.6	8.7	8.7	8.8	10.1	10.0	10.0	10.1	11.6	11.6	11.5	11.6	13.2	13.2	13.0	13.3	15.0	15.0	15.0	15.1	17.2	17.2	17.2	17.3		
Hi PR	290	294	296	301	334	335	337	342	375	377	379	384	419	421	423	427	466	467	469	474	514	515	517	522		
Lo PR	121	123	129	140	129	131	137	149	136	138	145	156	142	144	151	163	148	150	157	169	155	158	165	177		
1450	MBh	36.9	37.4	38.5	40.1	35.8	36.3	37.4	39.0	34.2	34.7	35.7	37.2	31.9	32.4	33.4	34.9	29.4	29.9	30.9	32.3	28.0	28.5	29.4	30.9	
	S/T	1.00	0.92	0.78	0.63	1.01	0.92	0.78	0.63	1.00	0.95	0.81	0.66	1.00	0.97	0.83	0.68	1.00	1.00	0.85	0.70	1.00	1.00	0.90	0.75	
	ΔT	25	23	20	16	24	22	19	16	24	22	19	16	23	21	18	15	22	21	18	15	23	21	18	15	
	kW	2.36	2.35	2.35	2.37	2.67	2.67	2.67	2.69	3.03	3.03	3.02	3.05	3.42	3.42	3.41	3.43	3.85	3.85	3.85	3.87	4.42	4.41	4.41	4.43	
	Amps	8.8	8.8	8.7	8.8	10.1	10.1	10.1	10.2	11.6	11.6	11.6	11.7	13.3	13.2	13.2	13.3	15.1	15.0	15.0	15.1	17.3	17.3	17.3	17.4	
	Hi PR	296	297	299	304	337	338	340	345	378	379	381	386	422	423	425	430	468	470	472	476	517	518	520	524	
	Lo PR	121	123	129	140	129	131	137	149	136	138	145	156	142	144	151	163	148	150	157	169	155	158	165	177	
	1070	MBh	32.9	36.8	37.8	39.5	35.2	35.7	36.7	38.3	33.6	34.0	35.1	36.6	31.3	31.8	32.8	34.3	28.8	29.3	30.3	31.8	27.4	27.9	28.9	30.3
		S/T	1.01	0.91	0.77	0.62	1.01	0.91	0.77	0.62	1.00	0.93	0.79	0.65	1.00	1.00	0.81	0.66	1.00	1.00	0.83	0.69	1.00	1.00	1.00	0.74
		ΔT	29	27	26	22	30	28	25	22	29	28	25	21	29	27	24	21	28	26	23	20	28	26	24	20
kW		1.77	2.32	2.32	2.34	2.64	2.64	2.64	2.66	3.00	3.00	2.99	3.02	3.39	3.39	3.38	3.40	3.82	3.82	3.82	3.84	4.39	4.38	4.38	4.40	
Amps		6.6	8.6	8.6	8.7	10.0	10.0	10.0	10.1	11.5	11.5	11.5	11.6	13.1	13.1	13.1	13.2	14.9	14.9	14.9	15.0	17.2	17.2	17.2	17.3	
Hi PR		288	292	294	299	332	333	335	340	374	375	377	382	418	419	421	426	464	465	467	472	512	514	515	520	
Lo PR		120	121	127	138	126	128	135	146	133	135	142	153	139	141	148	160	145	147	154	167	153	155	162	175	
1260		MBh	36.8	37.3	38.4	40.0	35.8	36.2	37.3	38.9	34.1	34.6	35.6	37.1	31.9	32.3	33.3	34.8	29.3	29.8	30.8	32.3	27.9	28.4	29.4	30.9
		S/T	1.01	0.99	0.84	0.70	1.01	0.99	0.85	0.70	1.00	1.00	0.87	0.72	1.00	1.00	0.89	0.74	1.00	1.00	0.91	0.76	1.00	1.00	1.00	0.82
		ΔT	29	27	24	21	29	27	24	20	28	27	23	20	27	26	23	19	26	25	22	19	26	24	21	18
	kW	2.35	2.34	2.34	2.36	2.66	2.66	2.66	2.68	3.02	3.02	3.01	3.04	3.41	3.41	3.40	3.42	3.84	3.84	3.84	3.86	4.41	4.40	4.40	4.42	
	Amps	8.7	8.7	8.7	8.8	10.1	10.1	10.0	10.1	11.6	11.6	11.6	11.7	13.2	13.2	13.2	13.3	15.0	15.0	15.0	15.1	17.3	17.3	17.2	17.3	
	Hi PR	294	295	297	302	335	336	338	343	377	378	380	385	421	422	424	429	467	468	470	475	515	516	518	523	
	Lo PR	121	123	129	140	128	130	137	148	135	137	144	156	141	143	150	162	147	150	156	169	151	152	154	166	
	1450	MBh	37.5	38.0	39.1	40.7	36.4	36.9	38.0	39.5	34.8	35.2	36.3	37.8	32.5	33.0	34.0	35.5	30.0	30.4	31.4	32.9	28.5	29.0	30.0	31.5
		S/T	1.01	1.01	0.88	0.73	1.01	1.01	0.89	0.74	1.00	1.00	0.91	0.76	1.00	1.00	0.93	0.78	1.00	1.00	0.90	0.80	1.00	1.00	1.00	0.85
		ΔT	28	26	23	20	28	26	23	19	27	25	22	19	26	25	22	18	26	24	21	18	26	24	21	18
kW		2.36	2.36	2.35	2.38	2.68	2.68	2.67	2.70	3.04	3.03	3.03	3.05	3.42	3.42	3.42	3.44	3.86	3.86	3.85	3.88	4.42	4.42	4.41	4.44	
Amps		8.8	8.8	8.8	8.9	10.1	10.1	10.1	10.2	11.7	11.6	11.6	11.7	13.3	13.3	13.2	13.3	15.1	15.1	15.0	15.1	17.3	17.3	17.3	17.4	
Hi PR		297	298	300	305	338	339	341	346	380	381	383	388	423	425	427	431	470	471	473	478	518	519	521	526	
Lo PR		123	125	131	142	131	133	139	151	138	140	146	158	144	146	153	165	150	152	159	171	157	159	166	179	

IDB = Entering Indoor Dry Bulb Temperature
 High and low pressures are measured at the liquid and suction service valves.
 Airflow may vary depending on actual ambient conditions and system operation modes.
 Shaded areas is AHRI conditions.
 kW = Total system power
 Amps = outdoor unit amps (comp. fan)

GXV6SS1810A* / AHVE24BP1300A*				
DESIGN SUBCOOLING @ AHRI 95 °F CONDITIONS, 9-11 °F				
- 100 % DEMAND				
OUTDOOR TEMP. °F	TOTAL BTU/H	SENSIBLE BTU/H	LATENT BTU/H	TOTAL WATTS
75°	19,000	13,500	5,500	1,080
80°	18,600	13,400	5,200	1,165
85°	18,100	13,200	4,900	1,250
90°	17,600	13,000	4,600	1,340
95°	17,100	12,800	4,300	1,430
100°	16,400	12,500	3,900	1,540
105°	15,700	12,100	3,600	1,650
110°	15,100	12,000	3,100	1,775
115°	14,500	11,900	2,600	1,900
TVA Conditions @ 95° OD DB, 75° ID, 63° ID WB				
95°	16,400	12,500	3,900	1,430

"GXV6SS1810A* / AHVE24BP1300A*				
DESIGN SUBCOOLING @ AHRI 95 °F CONDITIONS, 9-11 °F				
- BOOST MODE"				
OUTDOOR TEMP. °F	TOTAL BTU/H	SENSIBLE BTU/H	LATENT BTU/H	TOTAL WATTS
75°	20,500	14,800	5,700	1,100
80°	20,000	14,600	5,400	1,200
85°	19,500	14,400	5,100	1,300
90°	18,900	14,200	4,700	1,400
95°	18,300	13,900	4,400	1,450
100°	17,600	13,600	4,000	1,600
105°	16,900	13,200	3,700	1,700
110°	16,300	13,100	3,200	1,800
115°	15,700	13,000	2,700	1,950
TVA Conditions @ 95° OD DB, 75° ID, 63° ID WB				
95°	17,600	13,600	4,000	1,450

GXV6SS2410A* / AHVE24BP1300A*				
DESIGN SUBCOOLING @ AHRI 95 °F CONDITIONS, 11-13 °F				
- 100 % DEMAND				
OUTDOOR TEMP. °F	TOTAL BTU/H	SENSIBLE BTU/H	LATENT BTU/H	TOTAL WATTS
75°	26,000	18,200	7,800	1,790
80°	25,400	18,000	7,400	1,910
85°	24,700	17,800	6,900	2,030
90°	24,000	17,500	6,500	2,150
95°	23,200	17,200	6,000	2,270
100°	22,200	16,600	5,600	2,420
105°	21,100	16,000	5,100	2,570
110°	20,300	15,900	4,400	2,740
115°	19,400	15,700	3,700	2,910
TVA Conditions @ 95° OD DB, 75° ID, 63° ID WB				
95°	22,200	16,700	5,500	2,290

GXV6SS2410A* / AHVE24BP1300A*				
DESIGN SUBCOOLING @ AHRI 95 °F CONDITIONS, 11-13 °F				
- BOOST MODE				
OUTDOOR TEMP. °F	TOTAL BTU/H	SENSIBLE BTU/H	LATENT BTU/H	TOTAL WATTS
75°	28,300	20,100	8,200	1,900
80°	27,600	19,900	7,700	2,000
85°	26,900	19,600	7,300	2,150
90°	26,000	19,200	6,800	2,300
95°	25,100	18,800	6,300	2,400
100°	24,100	18,300	5,800	2,600
105°	23,000	17,700	5,300	2,700
110°	22,100	17,600	4,500	2,900
115°	21,200	17,400	3,800	3,100
TVA Conditions @ 95° OD DB, 75° ID, 63° ID WB				
95°	24,200	18,400	5,800	2,400

GXV6SS3010A* / AHVE36CP1300A*				
DESIGN SUBCOOLING @ AHRI 95 °F CONDITIONS, 13-15 °F				
- 100 % DEMAND				
OUTDOOR TEMP. °F	TOTAL BTU/H	SENSIBLE BTU/H	LATENT BTU/H	TOTAL WATTS
75°	31,800	22,900	8,900	2,280
80°	31,000	22,800	8,200	2,415
85°	30,200	22,700	7,500	2,550
90°	29,300	22,300	7,000	2,695
95°	28,400	21,900	6,500	2,840
100°	27,200	21,300	5,900	3,000
105°	25,900	20,700	5,200	3,160
110°	24,900	20,600	4,300	3,345
115°	23,800	20,500	3,300	3,530
TVA Conditions @ 95° OD DB, 75° ID, 63° ID WB				
95°	27,100	21,100	6,000	2,850

GXV6SS3010A* / AHVE36CP1300A*				
DESIGN SUBCOOLING @ AHRI 95 °F CONDITIONS, 13-15 °F				
- BOOST MODE				
OUTDOOR TEMP. °F	TOTAL BTU/H	SENSIBLE BTU/H	LATENT BTU/H	TOTAL WATTS
75°	34,700	24,600	10,100	2,350
80°	33,900	24,500	9,400	2,500
85°	33,000	24,400	8,600	2,600
90°	31,900	23,900	8,000	2,800
95°	30,700	23,300	7,400	2,900
100°	29,500	22,800	6,700	3,100
105°	28,200	22,300	5,900	3,250
110°	27,100	22,100	5,000	3,400
115°	26,000	21,800	4,200	3,600
TVA Conditions @ 95° OD DB, 75° ID, 63° ID WB				
95°	29,600	22,800	6,800	2,900

PERFORMANCE DATA FOR STANDARD OPERATING MODE (CONT.)

GXV6SS3610A* / AHVE36CP1300A*				
DESIGN SUBCOOLING @ AHRI 95 °F CONDITIONS, 14-16 °F				
- 100 % DEMAND				
OUTDOOR TEMP. °F	TOTAL BTU/H	SENSIBLE BTU/H	LATENT BTU/H	TOTAL WATTS
75°	38,300	28,000	10,300	3,050
80°	37,300	27,600	9,700	3,240
85°	36,300	27,200	9,100	3,430
90°	35,300	26,800	8,500	3,615
95°	34,200	26,300	7,900	3,800
100°	32,500	25,300	7,200	4,055
105°	30,800	24,300	6,500	4,310
110°	29,800	24,600	5,200	4,350
115°	28,800	24,800	4,000	4,390
TVA Conditions @ 95° OD DB, 75° ID, 63° ID WB				
95°	32,500	25,400	7,100	3,850

GXV6SS3610A* / AHVE36CP1300A*				
DESIGN SUBCOOLING @ AHRI 95 °F CONDITIONS, 14-16 °F				
- BOOST MODE				
OUTDOOR TEMP. °F	TOTAL BTU/H	SENSIBLE BTU/H	LATENT BTU/H	TOTAL WATTS
75°	41,200	30,100	11,100	3,100
80°	40,100	29,700	10,400	3,300
85°	39,000	29,300	9,700	3,450
90°	37,600	28,600	9,000	3,700
95°	36,200	27,900	8,300	3,900
100°	34,700	27,000	7,700	4,100
105°	33,100	26,100	7,000	4,350
110°	31,000	25,500	5,500	4,400
115°	28,800	24,800	4,000	4,400
TVA Conditions @ 95° OD DB, 75° ID, 63° ID WB				
95°	34,900	27,200	7,700	3,900

GXV6SS4210A* / AHVE48DP1300A*				
DESIGN SUBCOOLING @ AHRI 95 °F CONDITIONS, 7-9 °F				
- 100 % DEMAND				
OUTDOOR TEMP. °F	TOTAL BTU/H	SENSIBLE BTU/H	LATENT BTU/H	TOTAL WATTS
75°	44,000	30,400	13,600	3,720
80°	43,400	30,400	13,000	3,920
85°	42,800	30,400	12,400	4,120
90°	41,900	30,200	11,700	4,340
95°	41,000	29,900	11,100	4,560
100°	39,800	29,400	10,400	4,785
105°	38,500	28,900	9,600	5,010
110°	35,200	27,400	7,800	4,065
115°	31,900	25,800	6,100	3,120
TVA Conditions @ 95° OD DB, 75° ID, 63° ID WB				
95°	39,400	29,200	10,200	4,550

GXV6SS4210A* / AHVE48DP1300A*				
DESIGN SUBCOOLING @ AHRI 95 °F CONDITIONS, 7-9 °F				
- BOOST MODE				
OUTDOOR TEMP. °F	TOTAL BTU/H	SENSIBLE BTU/H	LATENT BTU/H	TOTAL WATTS
75°	47,600	31,900	15,700	3,100
80°	47,000	31,900	15,100	3,300
85°	46,300	31,900	14,400	3,450
90°	45,300	31,700	13,600	3,600
95°	44,200	31,400	12,800	3,800
100°	42,900	30,900	12,000	4,000
105°	41,600	30,400	11,200	4,150
110°	36,800	28,100	8,700	3,700
115°	31,900	25,800	6,100	3,150
TVA Conditions @ 95° OD DB, 75° ID, 63° ID WB				
95°	42,600	30,700	11,900	3,800

GXV6SS4810A* / AHVE48DP1300A*				
DESIGN SUBCOOLING @ AHRI 95 °F CONDITIONS, 8-10 °F				
- 100 % DEMAND				
OUTDOOR TEMP. °F	TOTAL BTU/H	SENSIBLE BTU/H	LATENT BTU/H	TOTAL WATTS
75°	50,700	34,500	16,200	4,130
80°	49,600	34,500	15,100	4,340
85°	48,400	34,400	14,000	4,550
90°	47,000	33,800	13,200	4,775
95°	45,500	33,200	12,300	5,000
100°	43,700	32,500	11,200	5,225
105°	41,800	31,800	10,000	5,450
110°	37,000	28,900	8,100	4,395
115°	32,100	26,000	6,100	3,340
TVA Conditions @ 95° OD DB, 75° ID, 63° ID WB				
95°	43,700	32,300	11,400	4,990

GXV6SS4810A* / AHVE48DP1300A*				
DESIGN SUBCOOLING @ AHRI 95 °F CONDITIONS, 8-10 °F				
- BOOST MODE				
OUTDOOR TEMP. °F	TOTAL BTU/H	SENSIBLE BTU/H	LATENT BTU/H	TOTAL WATTS
75°	56,000	35,800	20,200	4,100
80°	54,800	35,600	19,200	4,300
85°	53,500	35,300	18,200	4,500
90°	51,800	35,000	16,800	4,700
95°	50,100	34,600	15,500	4,950
100°	48,200	33,800	14,400	5,200
105°	46,300	32,900	13,400	5,400
110°	39,200	29,500	9,700	4,400
115°	32,100	26,000	6,100	3,350
TVA Conditions @ 95° OD DB, 75° ID, 63° ID WB				
95°	48,300	33,300	15,000	4,950

PERFORMANCE DATA FOR STANDARD OPERATING MODE (CONT.)

GXV6SS6010A* / AHVE60DP1300A*				
DESIGN SUBCOOLING @ AHRI 95 °F CONDITIONS, 8-10 °F				
- 100 % DEMAND				
OUTDOOR TEMP. °F	TOTAL BTU/H	SENSIBLE BTU/H	LATENT BTU/H	TOTAL WATTS
75°	59,000	40,100	18,900	4,710
80°	57,800	39,900	17,900	5,020
85°	56,500	39,600	16,900	5,330
90°	55,000	39,100	15,900	5,635
95°	53,500	38,500	15,000	5,940
100°	49,500	36,300	13,200	5,915
105°	45,400	34,100	11,300	5,890
110°	40,700	31,800	8,900	5,500
115°	35,900	29,400	6,500	5,110
TVA Conditions @ 95° OD DB, 75° ID, 63° ID WB				
95°	51,200	37,400	13,800	6,000

GXV6SS6010A* / AHVE60DP1300A*				
DESIGN SUBCOOLING @ AHRI 95 °F CONDITIONS, 8-10 °F				
- BOOST MODE				
OUTDOOR TEMP. °F	TOTAL BTU/H	SENSIBLE BTU/H	LATENT BTU/H	TOTAL WATTS
75°	62,400	40,600	21,800	5,950
80°	62,100	41,000	21,100	6,350
85°	61,500	41,200	20,300	6,700
90°	59,900	41,000	18,900	6,950
95°	57,500	40,300	17,200	7,300
100°	51,500	37,200	14,300	6,550
105°	45,400	34,000	11,400	5,900
110°	40,700	31,800	8,900	5,550
115°	35,900	29,500	6,400	5,150
TVA Conditions @ 95° OD DB, 75° ID, 63° ID WB				
95°	55,400	39,300	16,100	7,300

GXV6SA1810A* / AHVE24BP1300A*				
DESIGN SUBCOOLING @ AHRI 95 °F CONDITIONS, 9-11 °F				
- 100 % DEMAND				
OUTDOOR TEMP. °F	TOTAL BTU/H	SENSIBLE BTU/H	LATENT BTU/H	TOTAL WATTS
75°	19,000	13,500	5,500	1,080
80°	18,600	13,400	5,200	1,165
85°	18,100	13,200	4,900	1,250
90°	17,600	13,000	4,600	1,340
95°	17,100	12,800	4,300	1,430
100°	16,400	12,500	3,900	1,540
105°	15,700	12,100	3,600	1,650
110°	15,100	12,000	3,100	1,775
115°	14,500	11,900	2,600	1,900
TVA Conditions @ 95° OD DB, 75° ID, 63° ID WB				
95°	16,400	12,500	3,900	1,430

GXV6SA1810A* / AHVE24BP1300A*				
DESIGN SUBCOOLING @ AHRI 95 °F CONDITIONS, 9-11 °F				
- BOOST MODE				
OUTDOOR TEMP. °F	TOTAL BTU/H	SENSIBLE BTU/H	LATENT BTU/H	TOTAL WATTS
75°	20,500	14,800	5,700	1,100
80°	20,000	14,600	5,400	1,200
85°	19,500	14,400	5,100	1,300
90°	18,900	14,200	4,700	1,400
95°	18,300	13,900	4,400	1,450
100°	17,600	13,600	4,000	1,600
105°	16,900	13,200	3,700	1,700
110°	16,300	13,100	3,200	1,800
115°	15,700	13,000	2,700	1,950
TVA Conditions @ 95° OD DB, 75° ID, 63° ID WB				
95°	17,600	13,600	4,000	1,450

GXV6SA2410A* / AHVE24BP1300A*				
DESIGN SUBCOOLING @ AHRI 95 °F CONDITIONS, 11-13 °F				
- 100 % DEMAND				
OUTDOOR TEMP. °F	TOTAL BTU/H	SENSIBLE BTU/H	LATENT BTU/H	TOTAL WATTS
75°	26,000	18,200	7,800	1,790
80°	25,400	18,000	7,400	1,910
85°	24,700	17,800	6,900	2,030
90°	24,000	17,500	6,500	2,150
95°	23,200	17,200	6,000	2,270
100°	22,200	16,600	5,600	2,420
105°	21,100	16,000	5,100	2,570
110°	20,300	15,900	4,400	2,740
115°	19,400	15,700	3,700	2,910
TVA Conditions @ 95° OD DB, 75° ID, 63° ID WB				
95°	22,200	16,700	5,500	2,290

GXV6SA2410A* / AHVE24BP1300A*				
DESIGN SUBCOOLING @ AHRI 95 °F CONDITIONS, 11-13 °F				
- BOOST MODE				
OUTDOOR TEMP. °F	TOTAL BTU/H	SENSIBLE BTU/H	LATENT BTU/H	TOTAL WATTS
75°	28,300	20,100	8,200	1,900
80°	27,600	19,900	7,700	2,000
85°	26,900	19,600	7,300	2,150
90°	26,000	19,200	6,800	2,300
95°	25,100	18,800	6,300	2,400
100°	24,100	18,300	5,800	2,600
105°	23,000	17,700	5,300	2,700
110°	22,100	17,600	4,500	2,900
115°	21,200	17,400	3,800	3,100
TVA Conditions @ 95° OD DB, 75° ID, 63° ID WB				
95°	24,200	18,400	5,800	2,400

PERFORMANCE DATA FOR STANDARD OPERATING MODE (CONT.)

GXV6SA3010A* / AHVE36CP1300A*				
DESIGN SUBCOOLING @ AHRI 95 °F CONDITIONS, 13-15 °F				
- 100 % DEMAND				
OUTDOOR TEMP. °F	TOTAL BTU/H	SENSIBLE BTU/H	LATENT BTU/H	TOTAL WATTS
75°	31,800	22,900	8,900	2,280
80°	31,000	22,800	8,200	2,415
85°	30,200	22,700	7,500	2,550
90°	29,300	22,300	7,000	2,695
95°	28,400	21,900	6,500	2,840
100°	27,200	21,300	5,900	3,000
105°	25,900	20,700	5,200	3,160
110°	24,900	20,600	4,300	3,345
115°	23,800	20,500	3,300	3,530
TVA Conditions @ 95° OD DB, 75° ID, 63° ID WB				
95°	27,100	21,100	6,000	2,850

GXV6SA3010A* / AHVE36CP1300A*				
DESIGN SUBCOOLING @ AHRI 95 °F CONDITIONS, 13-15 °F				
- BOOST MODE				
OUTDOOR TEMP. °F	TOTAL BTU/H	SENSIBLE BTU/H	LATENT BTU/H	TOTAL WATTS
75°	34,700	24,600	10,100	2,350
80°	33,900	24,500	9,400	2,500
85°	33,000	24,400	8,600	2,600
90°	31,900	23,900	8,000	2,800
95°	30,700	23,300	7,400	2,900
100°	29,500	22,800	6,700	3,100
105°	28,200	22,300	5,900	3,250
110°	27,100	22,100	5,000	3,400
115°	26,000	21,800	4,200	3,600
TVA Conditions @ 95° OD DB, 75° ID, 63° ID WB				
95°	29,600	22,800	6,800	2,900

GXV6SA3610A* / CAPEA3626*3A* + MBVK16CP1***A*				
DESIGN SUBCOOLING @ AHRI 95 °F CONDITIONS, 12-14 °F				
- 100 % DEMAND				
OUTDOOR TEMP. °F	TOTAL BTU/H	SENSIBLE BTU/H	LATENT BTU/H	TOTAL WATTS
75°	36,700	27,200	9,500	2,650
80°	35,900	27,100	8,800	2,830
85°	35,000	27,000	8,000	3,010
90°	34,000	26,600	7,400	3,190
95°	33,000	26,100	6,900	3,370
100°	31,600	25,300	6,300	3,600
105°	30,200	24,500	5,700	3,830
110°	29,100	24,300	4,800	4,090
115°	28,800	24,800	4,000	4,400
TVA Conditions @ 95° OD DB, 75° ID, 63° ID WB				
95°	31,600	25,300	6,300	3,400

GXV6SA3610A* / CAPEA3626*3A* + MBVK16CP1***A*				
DESIGN SUBCOOLING @ AHRI 95 °F CONDITIONS, 12-14 °F				
- BOOST MODE				
OUTDOOR TEMP. °F	TOTAL BTU/H	SENSIBLE BTU/H	LATENT BTU/H	TOTAL WATTS
75°	41,200	30,100	11,100	3,100
80°	40,100	29,700	10,400	3,300
85°	39,000	29,300	9,700	3,450
90°	37,600	28,600	9,000	3,700
95°	36,200	27,900	8,300	3,900
100°	34,700	27,000	7,700	4,100
105°	33,100	26,100	7,000	4,350
110°	31,000	25,500	5,500	4,400
115°	28,800	24,800	4,000	4,400
TVA Conditions @ 95° OD DB, 75° ID, 63° ID WB				
95°	34,900	27,200	7,700	3,900

NORMAL MODE		SOUND POWER LEVEL ¹						
TONNAGE	TOTAL UNIT SOUND RATING (dBA)	OCTAVE BAND SPECTRUM FREQUENCY (Hz) ANALYSIS (dB)						
		125	250	500	1000	2000	4000	8000
1.5-ton	61	48.1	53.4	57.3	55.2	48.8	41.6	36.9
2-ton	64	48.2	58.2	61.0	56.1	49.2	43.7	39.4
2.5-ton	67	57.9	58.4	62.9	61.1	55.1	48.3	41.2
3-ton	68	56.3	60.0	64.3	61.3	56.9	53.7	45.8
3.5-ton	71	60.3	64.5	65.2	65.8	60.9	54.4	48.1
4-ton	72	64.0	65.4	66.2	65.8	61.0	56.3	49.3
5-ton	73	62.9	66.4	67.0	67.4	63.0	58.9	50.6

¹Compliant with AHRI 270.

²Compliant with AHRI 220.

SOUND DATA - QUIET MODE

QUIET MODE

TONNAGE	SOUND SUPPRESSION LEVEL	SOUND POWER LEVEL (dBA)¹	SOUND PRESSURE LEVEL (dBA)²	CAPACITY DECREASE
1.5-ton	LV.1	63	46	~5%
	LV.2	60	43	~20%
	LV.3	57	40	~40%
2-ton	LV.1	64	47	~5%
	LV.2	61	44	~35%
	LV.3	58	41	~45%
2.5-ton	LV.1	65	51	~5%
	LV.2	62	48	~30%
	LV.3	59	45	~45%
3-ton	LV.1	65	51	~5%
	LV.2	62	48	~35%
	LV.3	59	45	~50%
3.5-ton	LV.1	67	55	~5%
	LV.2	62	50	~45%
	LV.3	57	45	~50%
4-ton	LV.1	67	55	~5%
	LV.2	62	50	~25%
	LV.3	57	45	~45%
5-ton	LV.1	68	55	~5%
	LV.2	63	50	~45%
	LV.3	58	45	~50%

¹ Quiet Mode Sound Power and Sound Pressure levels determined at a distance of 3 [ft].

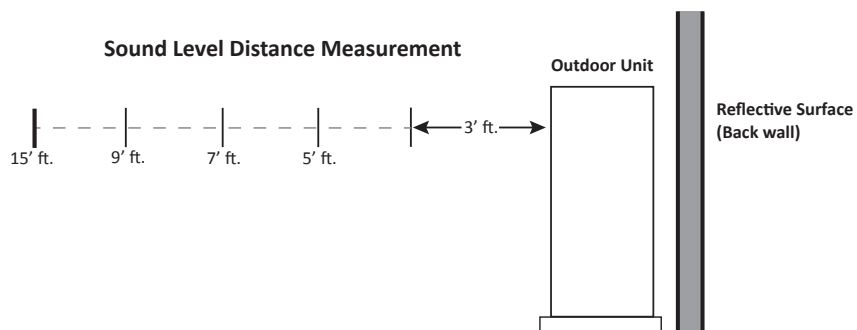

		SOUND PRESSURE (dBA) COOLING MODE ¹				
		DISTANCE FROM PROPERTY LINE				
TONNAGE	REFLECTIVE SURFACE QTY.	3'	5'	7'	9'	15'
1.5 Ton	0	54	49	46	44	40
	1	57	52	49	47	43
	2	60	55	52	50	46
2.0 Ton	0	57	52	49	47	43
	1	60	55	52	50	46
	2	63	58	55	53	49
2.5 Ton	0	60	55	52	50	46
	1	63	58	55	53	49
	2	66	61	58	56	52
3.0 Ton	0	61	56	53	51	47
	1	64	59	56	54	50
	2	67	62	59	57	53
3.5 Ton	0	64	59	56	54	50
	1	67	62	59	57	53
	2	70	65	62	60	56
4.0 Ton	0	65	60	57	55	51
	1	68	63	60	58	54
	2	71	66	63	61	57
5.0 Ton	0	66	61	58	56	52
	1	69	64	61	59	55
	2	72	67	64	62	58

¹ Compliant with AHRI 275 utilizing standard mode, total sound levels

All AHRI system ratings are accessible in the System Configurator tool via PartnerLink.

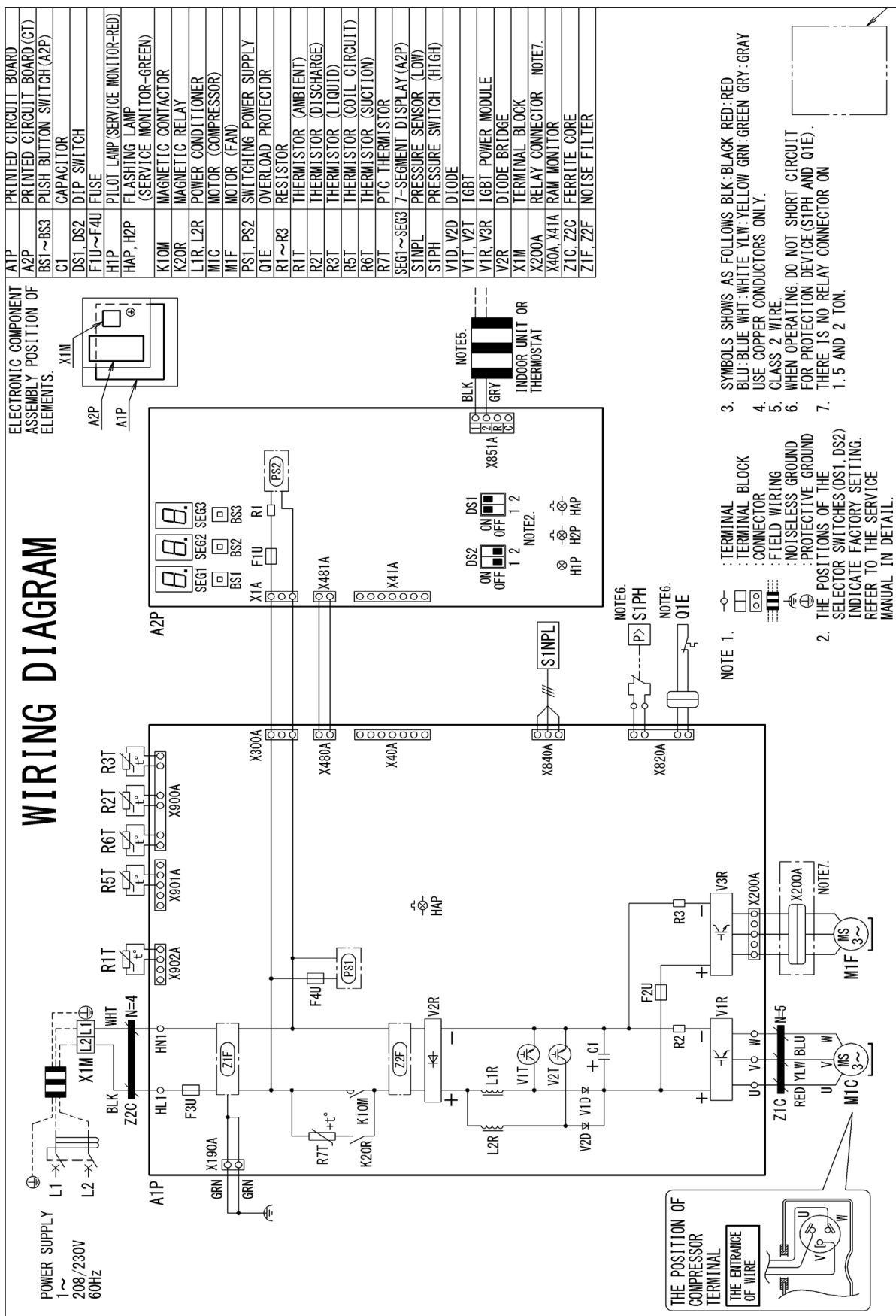

Wiring is subject to change. Always refer to the wiring diagram or the unit for the most up-to-date wiring.

High Voltage: Disconnect all power before servicing or installing this unit. Multiple power sources may be present. Failure to do so may cause property damage, personal injury, or death.

WARNING

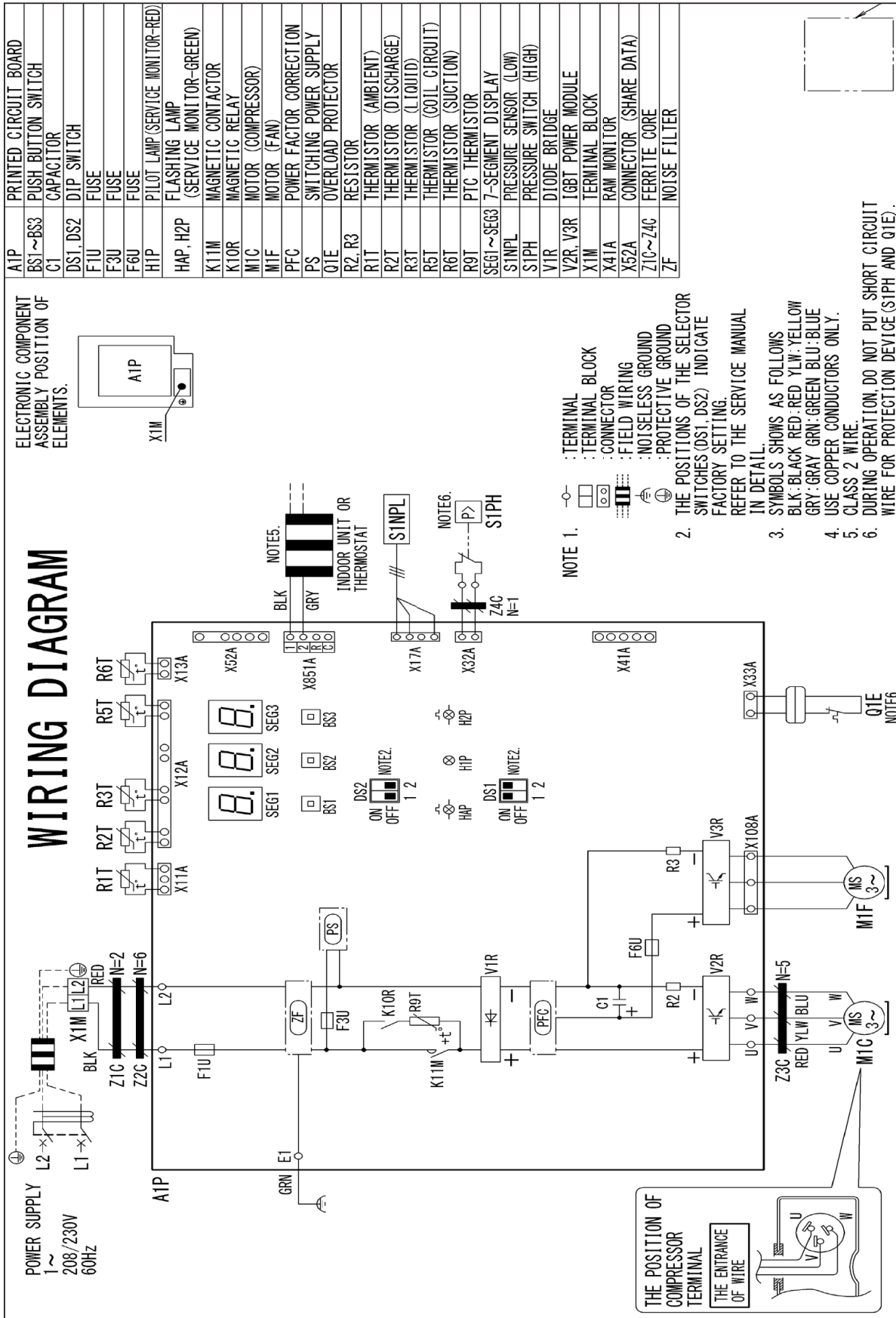

WARNING

High Voltage: Disconnect all power before servicing or installing this unit. Multiple power sources may be present. Failure to do so may cause property damage, personal injury, or death.

Wiring is subject to change. Always refer to the wiring diagram or the unit for the most up-to-date wiring.

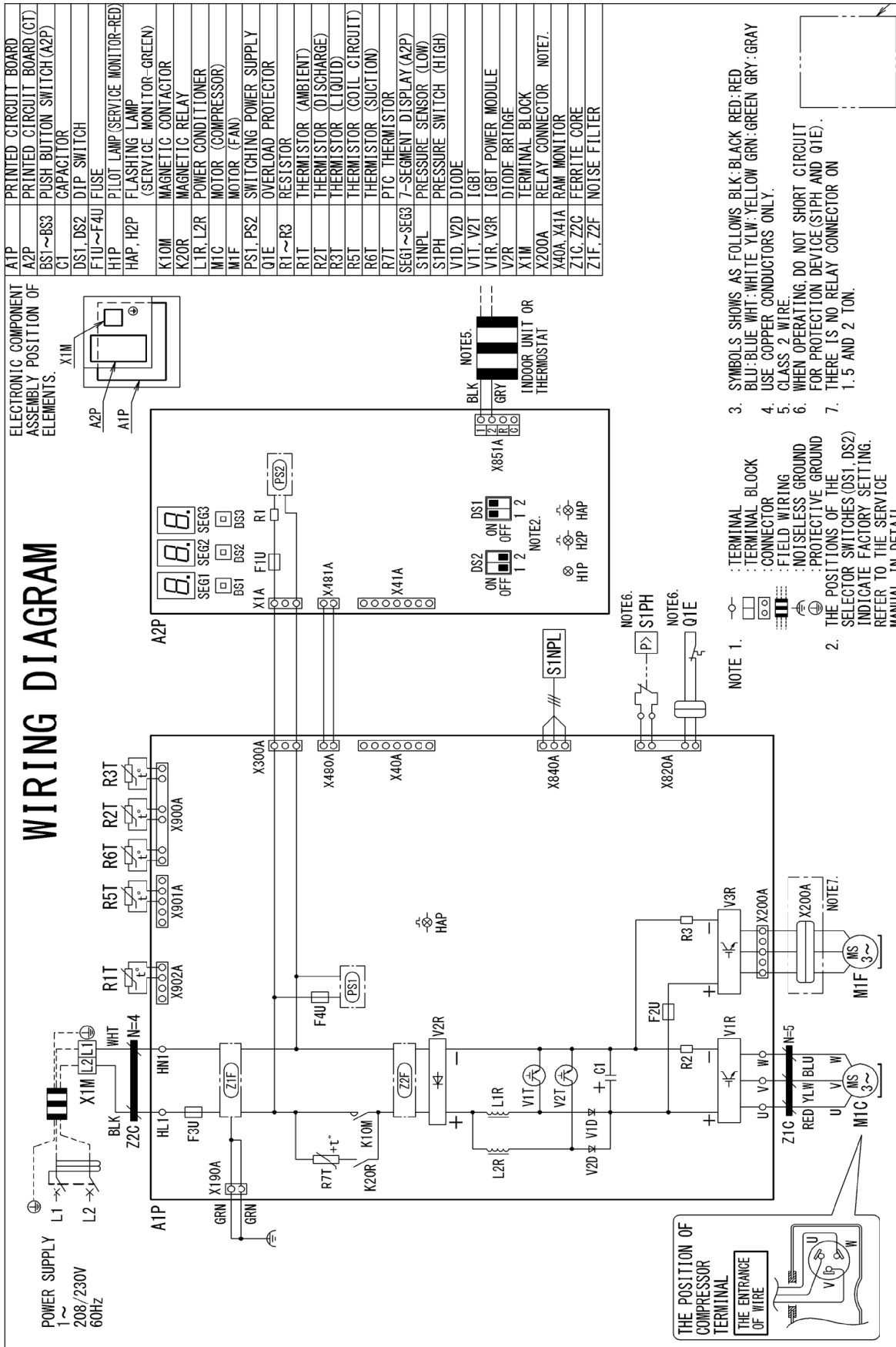

Wiring is subject to change. Always refer to the wiring diagram on the unit for the most up-to-date wiring.

WARNING

High Voltage: Disconnect all power before servicing or installing this unit. Multiple power sources may be present. Failure to do so may cause property damage, personal injury, or death.

DIMENSIONS

MODEL	DIMENSIONS		
	W"	D"	H"
GXV6SS1810A*/ GXV6SA1810A*	36 $\frac{5}{8}$	13 $\frac{3}{4}$	27 $\frac{3}{8}$
GXV6SS2410A*/ GXV6SA2410A*	36 $\frac{5}{8}$	13 $\frac{3}{4}$	27 $\frac{3}{8}$
GXV6SS3010A*/ GXV6SA3010A*	36 $\frac{5}{8}$	13 $\frac{3}{4}$	27 $\frac{3}{8}$
GXV6SS3610A*/ GXV6SA3610A*	36 $\frac{5}{8}$	13 $\frac{3}{4}$	27 $\frac{3}{8}$

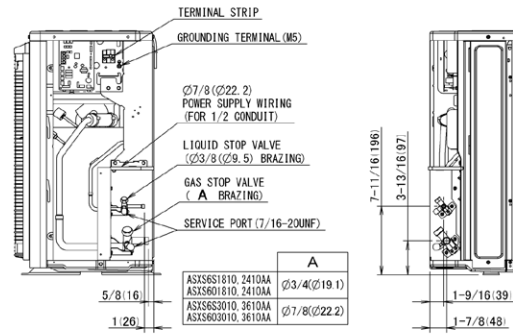
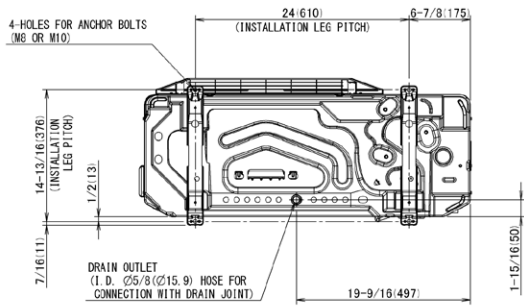
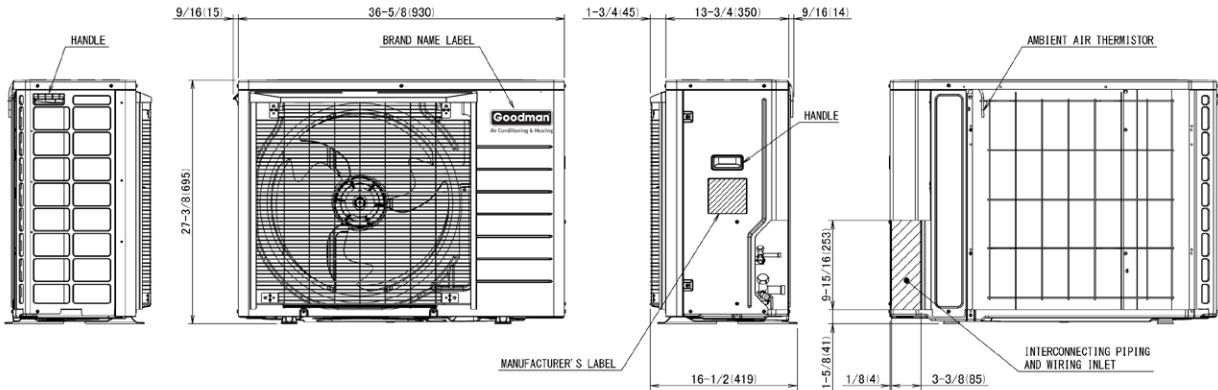

	A
ASXS6S1810, 2410A ASXS6S1810, 2410A	Ø3/4 (Ø19.1)
ASXS6S3010, 3610A ASXS6S3010, 3610A	Ø7/8 (Ø22.2)

IN CASE OF REMOVING RIGHT SIDE PLATE

UNIT : inch (mm)

MODEL	DIMENSIONS		
	W"	D"	H"
GXV6SS4210A*	37	12 $\frac{5}{8}$	39
GXV6SS4810A*	37	12 $\frac{5}{8}$	39
GXV6SS6010A*	37	12 $\frac{5}{8}$	39

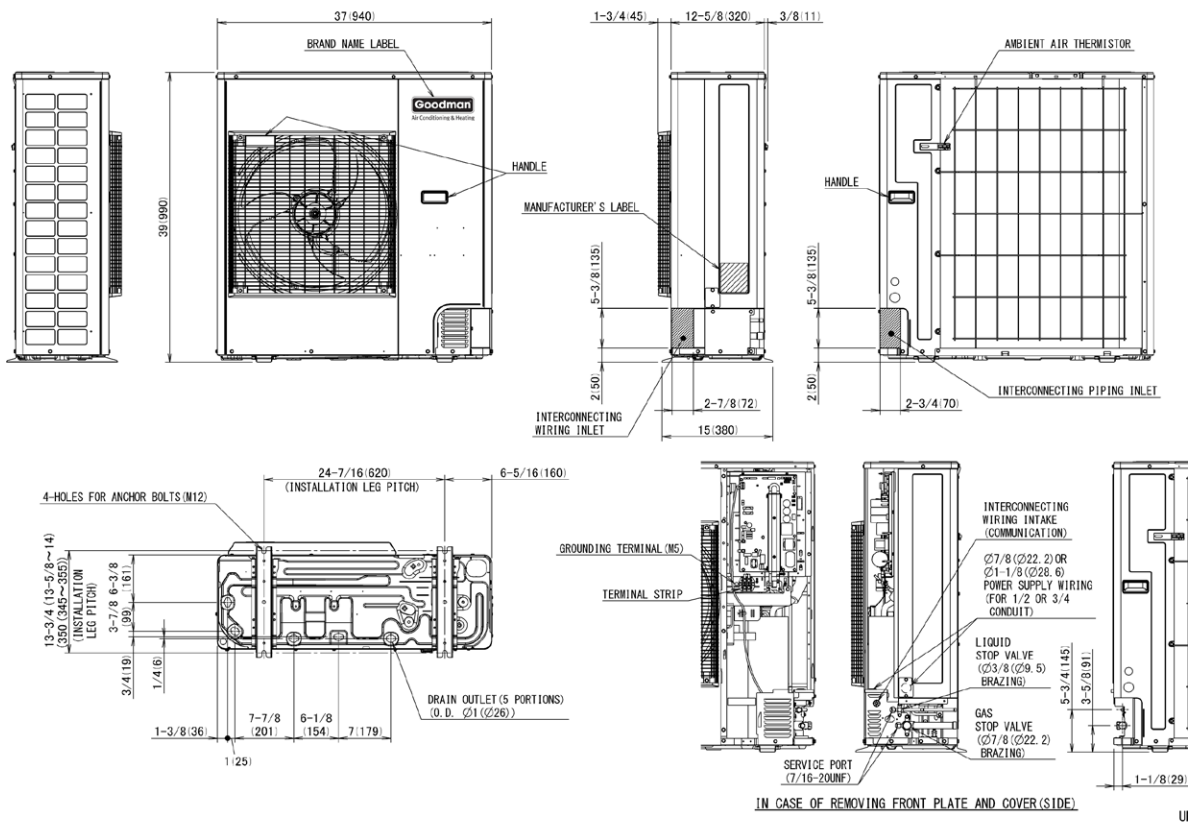

ACCESSORIES

MODEL	DESCRIPTION	GXV6SS 1810A*	GXV6SS 2410A*	GXV6SS 3010A*	GXV6SS 3610A*	GXV6SS 4210A*	GXV6SS 4810A*	GXV6SS 6010A*	GXV6SA 1810A*	GXV6SA 2410A*	GXV6SA 3010A*	GXV6SA 3610A*
KPW5G112	Wind Baffle	X	X	X	X	X	X	X	X	X	X	X
130-DK-006	Hail Guard	X	X	X	X				X	X	X	X
130-DK-008	Hail Guard					X	X	X				
DACA-WB-3	Powder Coated Wall-Mounted Bracket	X	X	X	X	X	X	X	X	X	X	X
DTA119A72	D24V Gateway	X	X	X	X	X	X	X				

The manufacturing entity reserves the right to discontinue, or change at any time, specifications or designs without notice or without incurring obligations.