



# System Installation Guide

## ComfortNet™ CTK04 Communicating Thermostat

### With wireless accessories

Modulating control for up to 4 Heat/2 Cool communicating heat pump systems or up to 3 Heat/2 Cool communicating gas heat, electric cooling systems for residential and commercial applications.

### Installation guide for:

- ComfortNet CTK04 Communicating Thermostat
- Portable Comfort Control
- Wireless Outdoor Sensor
- Wireless Indoor Sensor
- RedLINK™ Internet Gateway
- Entry/Exit Remote
- Vent Boost Remote

### Quick start guide

1	Install thermostat .....	page 4
2	Power optional accessories .....	7
3	Setup thermostat .....	8
4	Link optional accessories .....	9
5	Mount optional accessories .....	11
6	Installer options .....	12
	ComfortNet™ User Menu .....	13
	Device replacement and specifications .....	21-23



**DISCONNECT POWER BEFORE INSTALLATION.** Can cause electrical shock or equipment damage.

**MERCURY NOTICE:** If this product is replacing a control that contains mercury in a sealed tube, do not place the old control in the trash. Contact the Thermostat Recycling Corporation at [www.thermostat-recycle.org](http://www.thermostat-recycle.org) or 800-238-8192 for information on how and where to properly and safely dispose of your old thermostat.

**Must be installed by a trained, experienced technician.** Read these instructions carefully. Failure to follow these instructions can damage the product or cause a hazardous condition.



69-2688-07

I/O-CHTSTAT03

## The ComfortNet advantage

---

The premium Honeywell ComfortNet™ control system is easy to use, energy-efficient, reliable and ensures the system is set up properly. Advanced operating algorithms built into the control delivers efficient equipment operation while providing optimal comfort. The Honeywell ComfortNet Communicating thermostat is designed to regulate and communicate with the central heating and cooling equipment and has the ability to share information so the user will enjoy efficient, economical comfort throughout the home.

### RedLINK™ Compatible

RedLINK accessories include the Wireless Outdoor Sensor, Portable Comfort Control (PCC), RedLINK Internet Gateway, Wireless Indoor Sensor, TrueSTEAM™ humidifier with Wireless Adapter, Vent Boost Remote and Entry/Exit Remote.

### Customizable Service Reminders

Set up to 10 service reminders. Choose from pre-set options or customize your own. Pre-set reminder options include filter replacement, humidifier maintenance, dehumidifier filter, ventilator filter, UV bulb replacement, annual service, spring service, fall service and warranty expiring soon. Reminders based on the date or outdoor temperature will be displayed on the thermostat's main screen along with pre-set or custom instructions.

### User Interactions Log

The interaction log stores history of thermostat setting changes including temperature, system and installer setup. You can use the interaction log to save time by determining if the issue is a system error or an accidental user error.

### Configurable for Residential and Light Commercial Applications

One thermostat does it all to meet the needs of Residential and Light Commercial applications. Simply select Residential or Commercial during the installer setup. If Commercial is selected, the thermostat will use commercial language, meet building codes and offer 365 day holiday scheduling.

### USB Port

Visit <http://thermostatsetup.honeywell.com> to enter your dealer information and save to a USB stick. Then load your dealer information and logo to multiple thermostats.

After setting up a thermostat, save Installer Setup, Holiday / Event Scheduler and Custom Reminders to a USB stick. Then load this information to multiple thermostats.

To use the USB port, insert a USB stick in the bottom of the thermostat. Then select the item you would like to load or save.

### Selectable Sensors

When paired with a Wireless Indoor Sensor(s) you have the ability to choose which sensor(s) to use for temperature, humidification and dehumidification. They can be used in combination for temperature averaging—or individually—to condition humidity levels in separate spaces.



## 1 Install thermostat

### Thermostat Mounting

Mount the thermostat approximately 5 feet from the floor on an interior wall using the included screws and anchors. Drill 3/16" holes for drywall and 7/32" holes for plaster.

Do not install the thermostat where it can be affected by:

- Drafts or dead spots behind doors and in corners.
- Hot or cold air from ducts.
- Radiant heat from sun or appliances.
- Concealed pipes and chimneys.
- Unheated (uncooled) areas such as an outside wall.

### Terminal Functions:

- 1 - Data 1
- 2 - Data 2
- R - 24 volt power
- C - 24 volt common

### Wire Gauge:

18 gauge wire is recommended. Maximum wire distance between the ComfortNet thermostat and the IFC should not exceed 100 feet using 18 gauge wire.

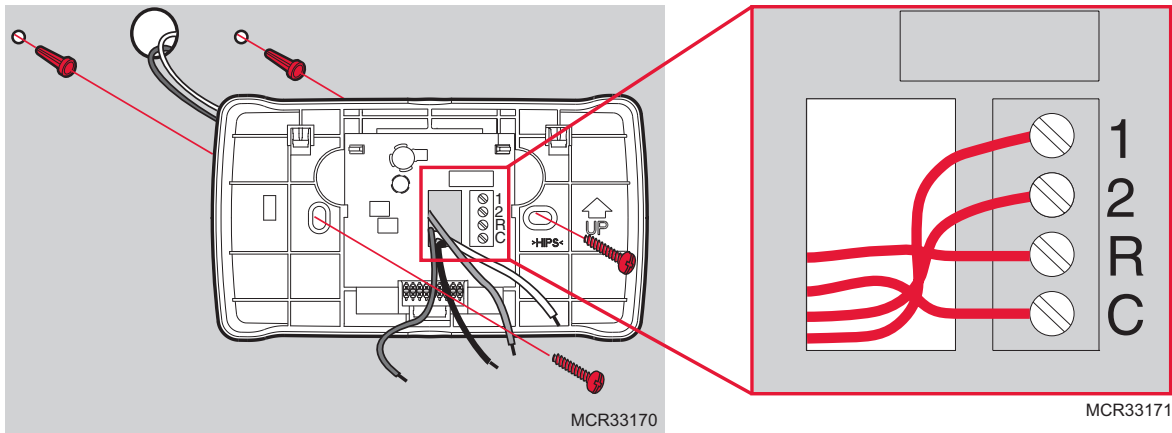

# 1 Install thermostat

## Wiring Thermostat, Indoor Unit and Outdoor Unit

### Wire Thermostat to Indoor Unit

Connect 1, 2, R and C from the thermostat to 1, 2, R and C at the Indoor Unit.

### Wire Outdoor Unit

Connect wires 1 and 2 from the Indoor Unit to 1 and 2 at the Outdoor Unit. Install the transformer provided and connect to R and C at the Outdoor Unit. (NOTE: installing the additional transformer is NOT required for inverter/variable speed outdoor communicating units. Additional transformer IS required for 2-stage outdoor communicating units.) Do NOT connect R and C between the Indoor Unit and Outdoor Unit. See below.

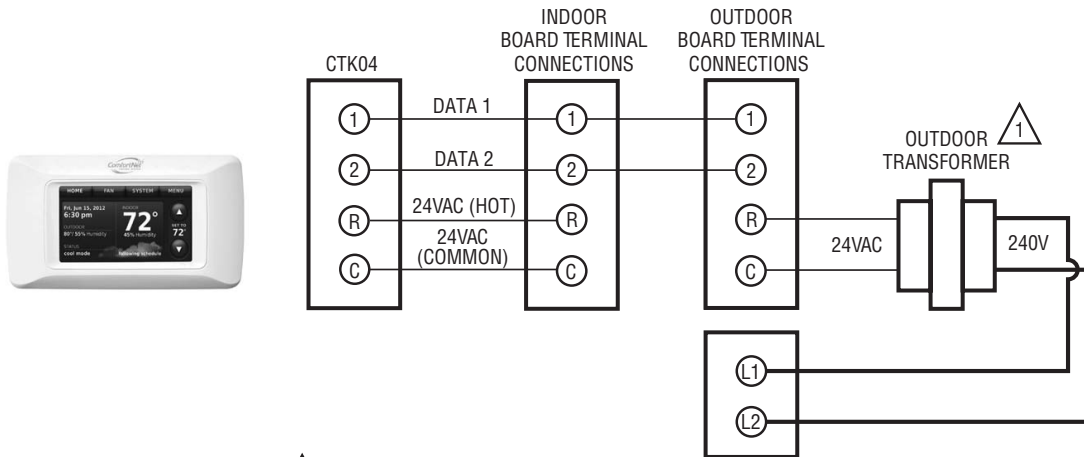

**1** INSTALLING THE ADDITIONAL TRANSFORMER IS NOT REQUIRED FOR INVERTER/VARIABLE SPEED OUTDOOR COMMUNICATING UNITS. ADDITIONAL TRANSFORMER IS REQUIRED FOR 2-STAGE OUTDOOR COMMUNICATING UNITS.

M33168C

## 2 Power optional accessories

[If no wireless accessories are used, skip to Section 3.]

### Outdoor air sensor

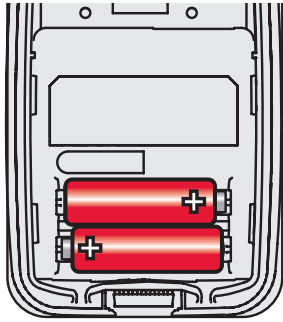

MCR32937

Install 2 fresh AA **lithium** batteries

### Indoor air sensor

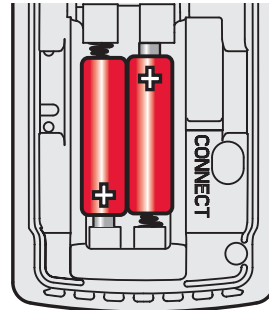

MCR32938

Install 2 fresh AAA alkaline batteries

### Portable Comfort Control

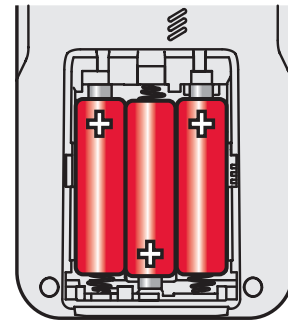

MCR32939

Install 3 fresh AA alkaline batteries

## RedLINK™ Internet Gateway

The Honeywell RedLINK Internet Gateway gives your customers remote access to home climate-control systems from any location with Internet access.

Using a Web browser, users can review and adjust indoor temperature, system mode and other settings. The Gateway can also send alerts to as many as 6 email addresses if a problem occurs.

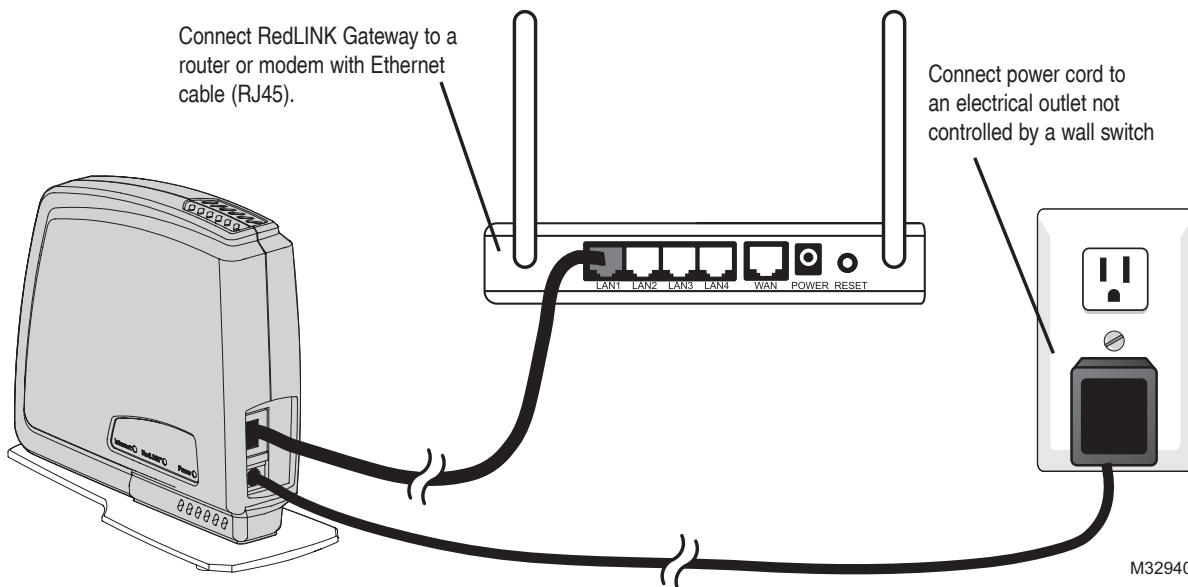

## 2 Power optional accessories

### TrueSTEAM

Connect the ABCD terminals between TrueSTEAM and the THM4000 Wireless Adapter.

Adjust the DIP Switches on TrueSTEAM as follows when using the Wireless Adapter:

DIP3: UP

DIP4: UP

DIP5: DOWN

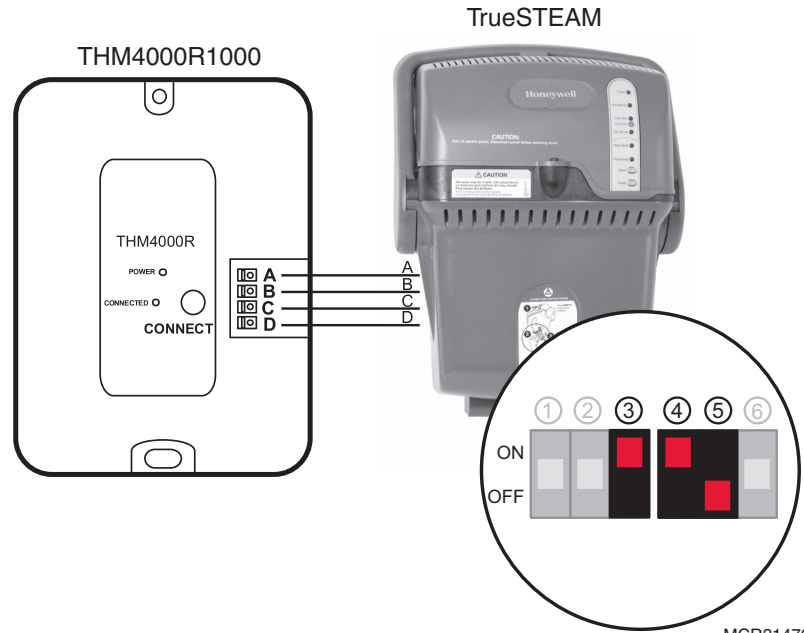

MCR31476

### Entry/Exit Remote or Vent Boost Remote

- 1 Remove the cover.
- 2 Insert the CR2450 coin cell battery (included) into the slot at the bottom of the remote. See polarity marking on the remote.
- 3 The LED will briefly flash green. If it flashes red, battery is not good.

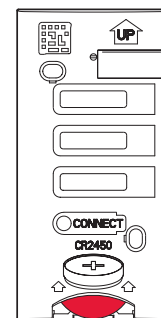

MCR33269

### 3 Setup thermostat

#### Initial Power Up

- 1 Turn on AC power to the system.



- 2 Select Language. Press Next.



- 3 Select Application (Residential or Commercial). Press Next.

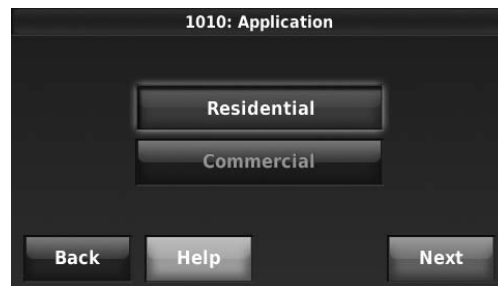

- 4 Enter a Device Name. Press Next.



The thermostat will automatically identify the ComfortNet communicating equipment installed and then you will be prompted to add RedLINK accessories (page 9) and setup the Installer Options (page 12).

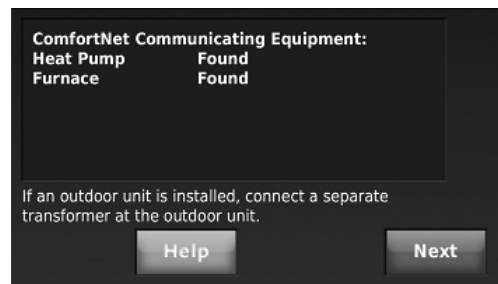



## 4 Link optional accessories to wireless network

If you need to return to the "Add Device" screen to add devices later, press **MENU** and scroll down to press **INSTALLER OPTIONS**. Enter the date code (password) when prompted. The date code is printed on the back of the thermostat; or press **MENU > EQUIPMENT STATUS** to find the date code. After you enter the password, scroll down to press **WIRELESS DEVICE MANAGER** and then select **ADD DEVICE**.

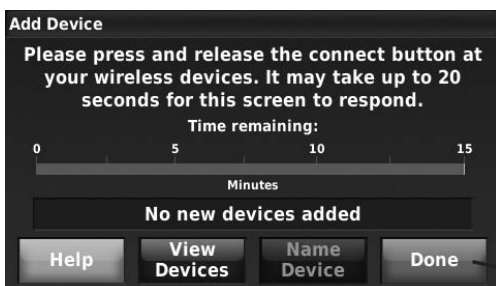

While the Add Device screen is displayed on the thermostat, press and release the **CONNECT** button on each wireless device, as described below. Accessories need to be at least 2 feet away from the thermostat during the linking process.

Press **DONE** after all devices have been linked

### Wireless outdoor sensor

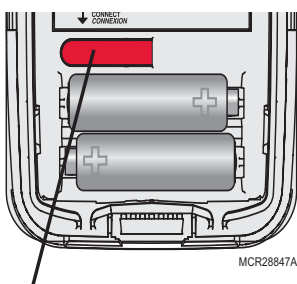

**i** When power is interrupted, the equipment and the RedLINK accessories will automatically restore communication after power resumes.

**i** If you have both a wired and wireless outdoor sensor installed, the thermostat displays the reading from the wireless outdoor sensor.

Press and release **CONNECT**. After a short delay the thermostat will display "Wireless Outdoor Sensor added" on the Add Device screen.

### Wireless indoor sensor

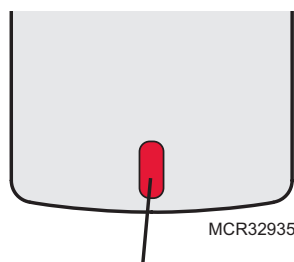
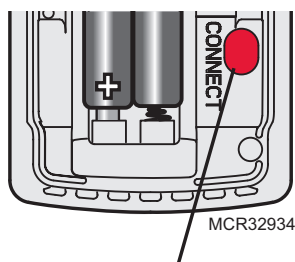

**i** The thermostat can use up to 6 optional wireless sensors.

Press and release **CONNECT**. After a short delay, the status light will glow green for 15 seconds.

If the status light turns red, the sensor did not link with the thermostat.

#### Battery level indicators (when batteries are inserted)

**Good:** Status light flashes green for 5 seconds.

**Low:** Status light flashes red for 5 seconds. Use fresh batteries.

#### Battery level indicators (during use)

**Good:** Status light remains off.

**Low:** Battery power will be depleted in about 2 months. Thermostat displays Low Battery warning. Status light remains off.

**Critical:** Battery power will be depleted in about 2-3 weeks. Status light flashes red.

## 4 Link optional accessories to wireless network

### Portable Comfort Control

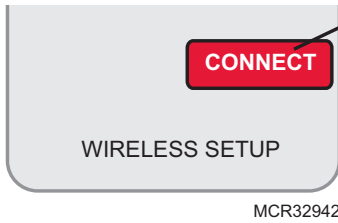

Press **CONNECT** on the Portable Comfort Control display screen. Press **DONE** when the screen displays "Connected." Press **NO** at the next screen to save and exit. (Or press **YES** to link another thermostat.)

**Error messages:**

- E1 29** Incompatible device cannot be connected.
- E1 34** Low RF signal. Move device to a different location and try again.
- E1 38** Make sure the thermostat is in Wireless Setup mode, and the Portable Comfort Control is at least 2 feet away.



The linking procedure will time out if there is no keypress for 30 minutes. To begin again, press and hold in the lower right corner of the screen until the display changes (about 3 seconds).



### RedLINK Internet Gateway

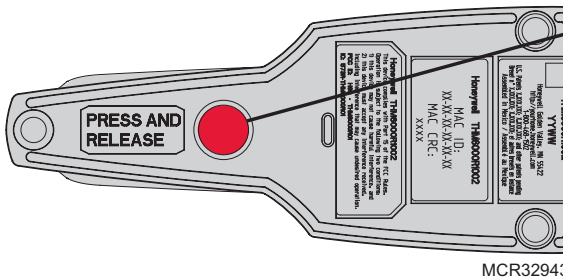

Press and release the button on the bottom of the Internet Gateway. After a short delay, the RedLINK status light will glow steady green.



The Internet Gateway must be registered online before use at [www.mytotalconnectcomfort.com](http://www.mytotalconnectcomfort.com). Enter the MAC ID and MAC CRC numbers located on the bottom of the Internet Gateway. For additional information, see instructions provided with the device.

### TrueSTEAM

Press and release the **CONNECT** button on the THM4000 Wireless Adapter. After a short delay, the **CONNECTED** status light will glow steady green..

### Entry/Exit Remote or Vent Boost Remote

Press and release **CONNECT** button.

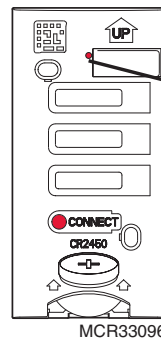

After a short delay, the status light will glow green for 15 seconds. If the status light turns red, the remote did not link with the thermostat for the connection process.

## 5 Mount optional accessories

[If no sensors are used, skip to Section 6.]

### To install outdoor air sensor

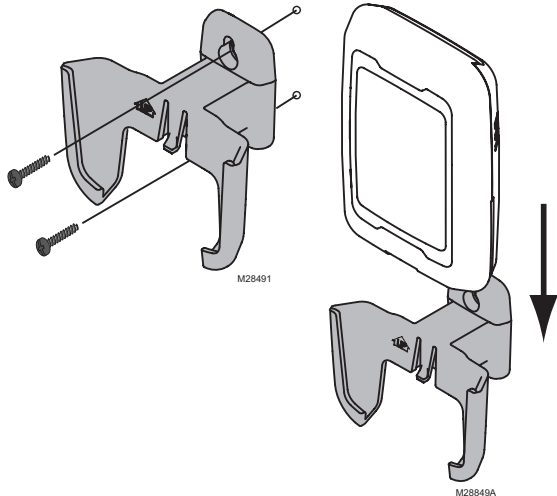

- 1 Mount the sensor on a vertical exterior wall, at least 6 inches below any overhang. Choose a location protected from direct sunlight.
- 2 Place sensor securely in bracket, facing away from wall.

### To install indoor air sensor

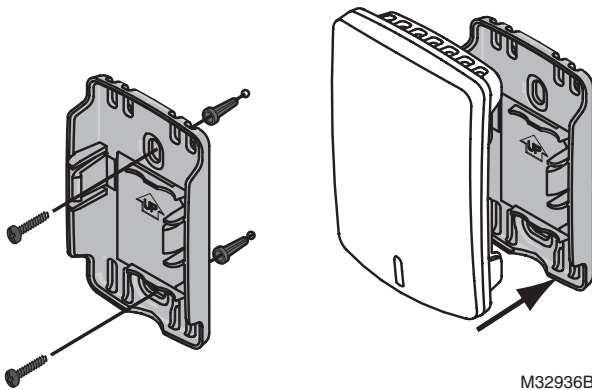

- 1 Remove the wallplate and mount it 4 to 6 feet above the floor on an interior wall. Drill 3/16-inch holes for drywall, 7/32-inch for plaster.
- 2 Attach sensor securely to wallplate as shown.

Do not install the indoor air sensor where it can be affected by:

- Drafts or dead spots behind doors and in corners.
- Hot or cold air from ducts.
- Radiant heat from sun or appliances.
- Concealed pipes and chimneys.
- Unheated (uncooled) areas such as an outside wall

### To install Entry/Exit Remote or Vent Boost Remote

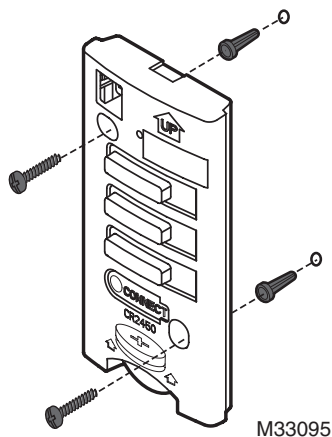

Mounting the remote is optional.

- 1 Remove the front cover from the remote.
- 2 Use provided screws and wall anchors to fasten the remote to the wall. Drill 3/16-inch holes for drywall, 7/32-inch for plaster.
- 3 Replace the cover on the remote.

## 6 Installer options (ISU)

To setup the thermostat, press **MENU** and scroll down to press **INSTALLER OPTIONS**. Enter the date code (password) when prompted. The date code is printed on the back of the thermostat; or press **MENU > EQUIPMENT STATUS** to find the date code. After you enter the password, press **CREATE SETUP** to setup the thermostat.

A brief summary of installer options follows. You can download a complete list of all options at <http://customer.honeywell.com>.



The screenshot shows the 'Menu > Installer Options' screen. The menu items are: Previous Menu, Help, Create Setup, View / Edit Current Setup, Installer Test, Data Logs, Wireless Device Manager, and Advanced Options. Callouts provide detailed instructions for each option.

- Create Setup:** Press **CREATE SETUP** to set all system settings one by one.
- View/Edit Current Setup:** Press **VIEW/EDIT CURRENT SETUP** to select a specific function and make quick changes.
- Installer Test:** Press **INSTALLER TEST** to quickly determine if the heat, cool, fan and thermostat are operating properly. Minimum off timers are ignored during the test.
- Data Logs:** Press **DATA LOGS** to view the Alerts Log and User Interactions Log.
- Wireless Device Manager:** Press **WIRELESS DEVICE MANAGER** to add or remove wireless accessories.
- Advanced Options:** Press **ADVANCED OPTIONS** to setup the thermostat using a USB device or to restore the thermostat to the factory default settings. See page 2 for more information on the USB port.

**TIP:** You can use the thermostat USB port to download all system configuration and installer options, including your company name and contact information. You can upload this data to each thermostat you install, to save time.

R: Residential C: Commercial B: Both

ISU	Function	ISU	Function
1000	Language	B	3150 Heat Cycles Per Hour
1010	Residential/Commercial	B	3160 Backup Heat Cycles Per Hour
1030	Device Name	B	3170-3190 Cooling Derivative, Integral, Throttling range
1030	Device Name on Home Screen	C	3200-3220 Heating Derivative, Integral, Throttling range
1040	Programmable/Non-programmable	B	3240 Minimum Compressor Off Time
1050	Fahrenheit/Celsius	B	3260 Extended Fan Run Time in Cool
1060	Outdoor Air Sensor	B	3260 Extended Fan Run Time in Heat
2000	Heating System Type	B	4000 Number of Schedule Periods
2010	Heating Equipment Type	B	4010 Pre-occupancy Purge Duration
2070	Heat Stages	B	4020 Override: Standard or Initiate Occupancy
2070	Cool/Compressor Stages	B	4030 Override Duration
2070	Backup Heat Stages	B	4050 Minimum Recovery Settings - Heat
2180	Backup Heat Type	B	4060 Maximum Recovery Settings - Heat
2190	System Zoning - Backup Heat Control	B	4070 Minimum Recovery Settings - Cool
3000	Manual/Auto Changeover	B	4080 Maximum Recovery Settings - Cool
3000	Auto Changeover Deadband	B	4090 Adaptive Intelligent Recovery
3010	Temperature Control Options	B	4100 Minimum Cool Setpoint
3020	Finish With High Cool Stage	B	4100 Maximum Heat Setpoint
3021	Finish With High Heat Stage	B	4110 Keypad Lockout
3030	Staging Control - Cool Differentials	B	4120 Entry/Exit Remote - Home/Occupied Cool Setpoint
3050-3060	Staging Control - Heat Differentials	B	4120 Entry/Exit Remote - Home/Occupied Heat Setpoint
3090	Staging Control - Backup Heat Differentials	B	4130 Entry/Exit Remote - Away/Unoccupied Cool Setpoint
3110	Backup Heat Upstage Timer	B	
3120	Outdoor Compressor Lockout	B	
3120	Outdoor Backup Heat Lockout	B	
3140	Cool/Compressor Cycles Per Hour	B	

## 6 Installer options (ISU)

ISU	Function	ISU	Function
4130	Entry/Exit Remote - Away/Unoccupied Heat Setpoint	9100	High Humidity Comfort Reset Setting
4140	Entry/Exit Remote - Vacation/Holiday Cool Setpoint	9180	Dehumidification Away Mode
4140	Entry/Exit Remote - Vacation/Holiday Heat Setpoint	9190	Dehumidification Away Mode - Fan Control
5040	Indoor Sensors Used for Temperature Control	9200	Dehumidification Away Mode - Low Limit Temperature
7000	Filter Type	9200	Dehumidification Away Mode - Temperature Setting
7020	Number of Air Filters	9200	Dehumidification Away Mode - Dehumidification Setting
7110	Air Filter Replacement Reminder	9210	Dehumidifier Filter Replacement Reminder
7110	Air Filter 2 Replacement Reminder	10000	Ventilation Type
7120	EAC Cell Cleaning Reminder	10050	Ventilation Control Method
7120	EAC Pre-Filter Cleaning Reminder	10090	Number of Bedrooms
7120	EAC Post-Filter Replacement Reminder	10090	Size of House
8000	Humidifier Type	10100	Enter Equipment Ventilation Rate
8010	Indoor Sensor Used for Humidification Control	10120	Ventilation Percent On Time
8050	Humidification - Window Protection	10170	Ventilator Filter Cleaning Reminder
8060	System Modes Allowing Humidification	11000	Number of UV Devices
8070	Humidification Control	11050	UV Bulb Replacement Reminder
8100	Clean Tank / Water Filter Replacement Reminder	11050	UV Bulb 2 Replacement Reminder
8100	Humidifier Pad Replacement Reminder	12000	Installer Custom Reminders
9000	Dehumidification Equipment	14000	Clock Format
9010	Indoor Sensor Used for Dehumidification Control	14010	Daylight Saving Time
9020	Humidity Sensor Displayed on the Home Screen	14020	Indoor Temperature Display Offset
9070	Dehumidification - Overcooling Limit	14020	Indoor Humidity Display Offset
9080	Dehumidification Control	15000-15020	Dealer name, phone, email, website, message
9090	Dehumidification Minimum On Time		

### ComfortNet User Menu

Press **MENU** > **COMFORTNET USER MENU**

Additional equipment information is found in the ComfortNet User Menu. Press **MENU** and scroll down to press **COMFORTNET USER MENU**. Enter the date code (password) when prompted. The date code is printed on the back of the thermostat; or press **MENU** > **EQUIPMENT STATUS** to find the date code.

After you enter the password, select the equipment type (furnace, air handler, air conditioner, heat pump) to view the specifications.

Each equipment type is divided into categories which may include: (Not all menu options listed here may be available. Additional menu options may be displayed on the thermostat.)

- **Configuration:** Provides information regarding the setup of the equipment. An example of configuration data is the number of cooling stages for an AC condensing unit.
- **Diagnostics:** Provides a fault history of the equipment and allows the installer to clear the fault history.
- **Identification:** Provides the model and serial number of the equipment and software revision information.
- **Sensors:** Provides the sensor data of the equipment. In some instances, it may allow the installer to setup or turn off a sensor.
- **Setup:** Allows the installer to change the settings of the equipment.
- **Status:** Provides the current status of the equipment.

See equipment installer manual for specific submenu options available within each category. Both indoor (Air Handler and Furnace) and outdoor (Air Conditioner and Heat Pump) units will have different sets of submenus.

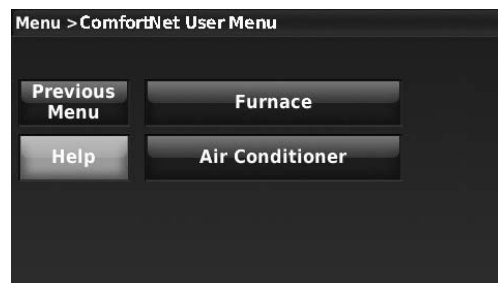

## Wiring humidifier to the IFC

To change installer setup (ISU) information, see pages 12-13.

### Wiring TrueSTEAM to IFC

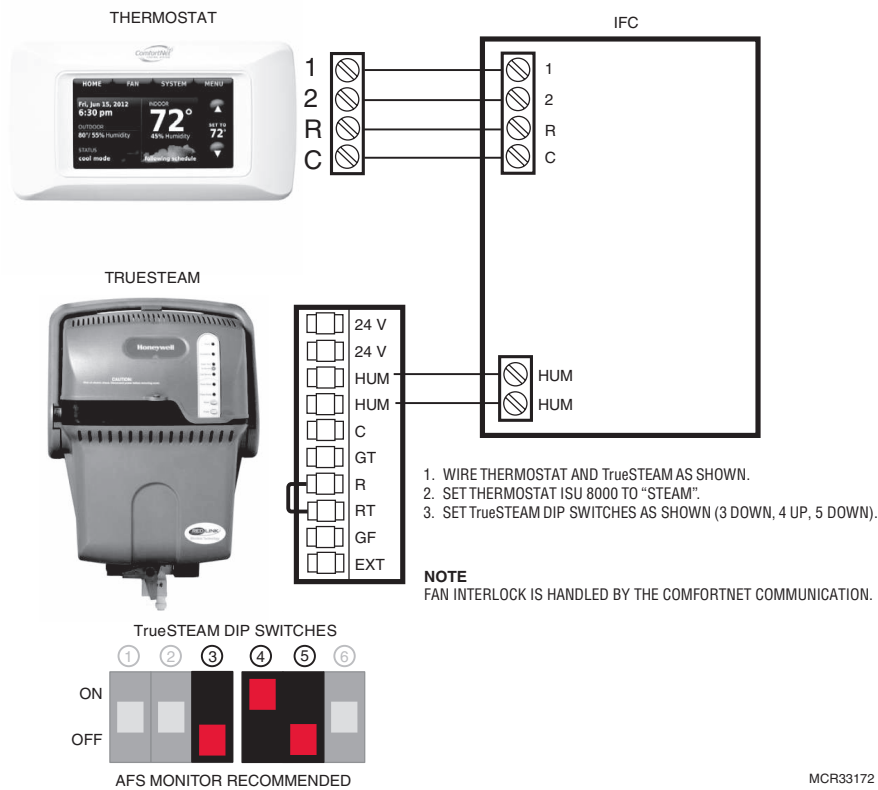

### Wiring TrueEASE to IFC

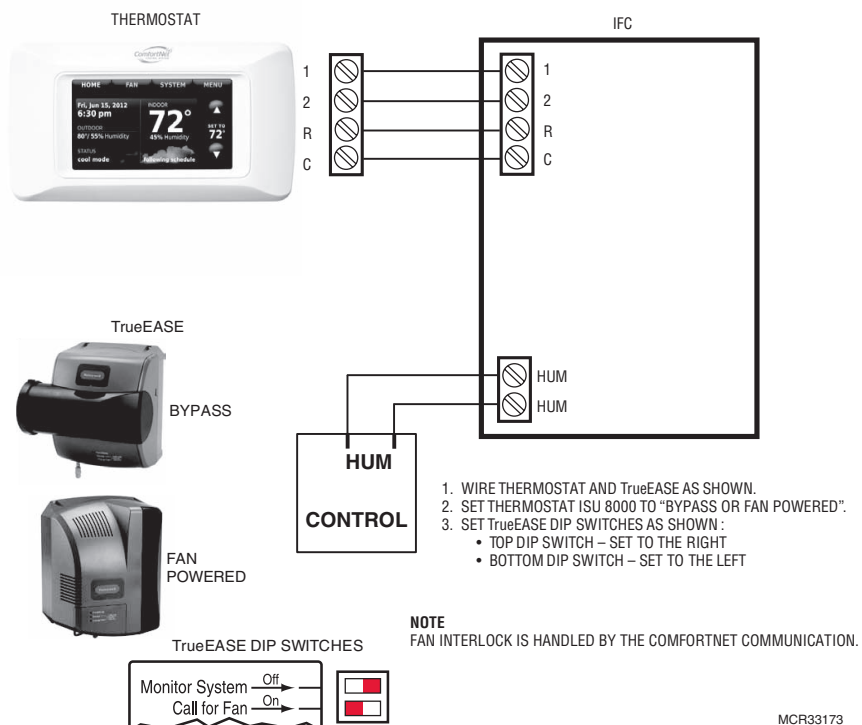

## Heat pump with outdoor temperature lockouts

Outdoor temperature lockouts are optional. See Installer Setup options (ISU 3120).

### Electric - Backup heat allowed to run with heat pump

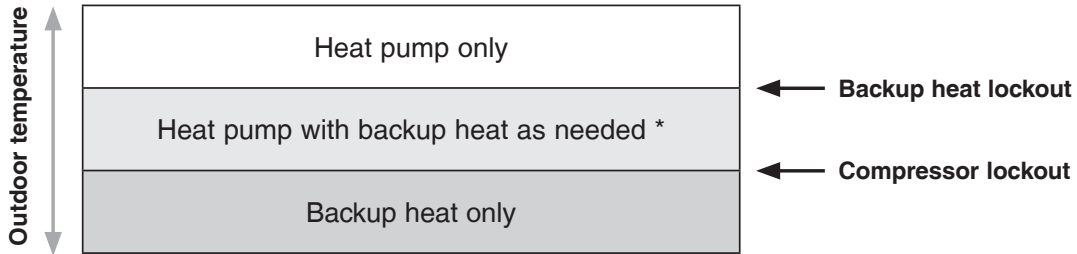

\* No backup heat unless indoor temperature drops to selected Backup Heat Differential setting, or Backup Heat Upstage Timer expires. **Heat pump stays ON when backup heat turns on.**

### Fossil Fuel - Backup heat NOT allowed to run with heat pump

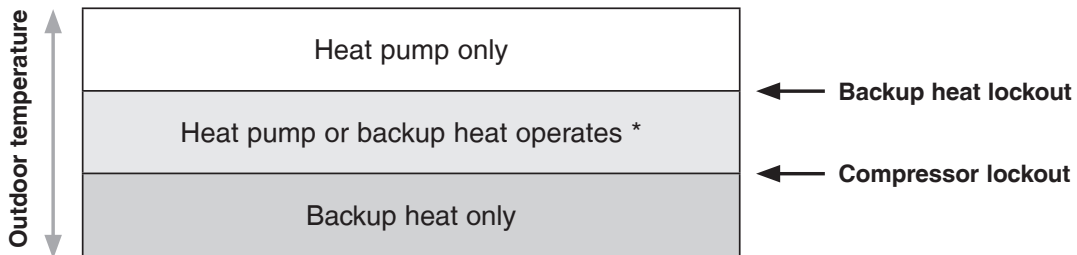

\* No backup heat unless indoor temperature drops to selected Backup Heat Differential setting, or Backup Heat Upstage Timer expires. **Heat pump turns OFF when backup heat turns on.**

## Basic and Advanced Temperature Control Options (ISU 3010)

---

**Basic Options:** The Installer Setup displays basic temperature control options which include Backup Heat Differential, Backup Heat Upstage Timer and Outdoor Temperature Lockouts. Note: Outdoor Temperature Lockouts only apply to Heat Pump applications.

**Advanced Options:** The Installer Setup displays both Basic and Advanced Options. Advanced temperature control options include Finish With High Cool Stage, Finish With High Heat Stage, Temperature Differential settings between all stages and Cycle Rate settings per stage.



Finish With High Heat or Cool Stage - When a multi-stage heating or cooling system is used, this feature keeps the high stage of the heating or cooling equipment running until the desired setpoint is reached.

## Backup heat differential and upstage timer

---

A backup heat differential and backup heat upstage timer can be set on heat pump systems with backup heat. See installer setup options (ISU 3090-3110).

### Normal operation

When the *Backup Heat Differential* is set to Comfort, the thermostat uses backup heat as needed to keep the indoor temperature within 1° F (0.5° C) of the setpoint.

When the *Backup Heat Differential* is set to 2° F or higher, backup heat is not used unless the indoor temperature drops to the *Backup Heat Differential* setting or the *Backup Heat Upstage Timer* expires, whichever occurs first. The upstage timer starts when the highest stage of the previous equipment type turns on.

### Manual temperature change

When the *Backup Heat Differential* is set to Comfort, the thermostat uses backup heat as needed to keep the indoor temperature within 1° F (0.5° C) of the setpoint.

When the *Backup Heat Differential* is set to 2° F or higher, if the heat pump is making progress as expected, backup heat will not be used to reach the new setpoint. Set to a higher number to use less backup heat (a greater difference between the current indoor temperature and the new setpoint is required to turn on backup heat). See notes below.

### Programmed recovery

If the heat pump is making progress as expected, backup heat will not be used to reach the setpoint of the next program period. Backup heat is always restricted during a programmed recovery when the Adaptive Intelligent Recovery feature is used. See note below.



During a programmed recovery (or when the temperature setpoint is changed by the user), the thermostat waits to turn on the backup heat depending on system performance, load conditions and how many degrees the temperature setpoint is changed. Backup heat will be used ONLY when the temperature is not rising quickly enough to reach the setpoint in a reasonable time.



If the backup heat was used in the last 2 hours because the heat pump was not able to maintain the setpoint, the thermostat may turn on the backup heat earlier when the user raises the setpoint.



## Humidification

The thermostat reads the indoor humidity level and allows the user to set a humidification setting with or without window protection.

### Window Protection

Window Protection limits the amount of humidity to prevent frost or condensation on windows. Window Protection (ISU 8050) requires an outdoor sensor.

The maximum humidity level that is allowed ("Window Limit") is displayed on the Humidification Settings screen. The thermostat prevents frost or condensation on windows by not allowing the humidity to go above the Window Limit when it is controlling the humidifier. This helps inform the user as to why their humidity setting might not be reached at times. The Window Limit is based on the current outdoor temperature and the user's window protection setting.

If Window Protection is turned Off, the thermostat controls the humidity level to the user's desired humidity setting. Frost or condensation may appear on windows.



To see all humidification options, press **MENU > INSTALLER OPTIONS > VIEW/EDIT CURRENT SETUP > HUMIDIFICATION.**

## Dehumidification - Residential

The thermostat reads the indoor humidity level and allows the user to set a dehumidification setting.

When set up for dehumidification using the cooling system, an overcooling limit can be set from 0 F to 3 F (ISU 9070). The thermostat uses the cooling system to reduce humidity by lowering the temperature up to 3 F below the current cool setpoint until the desired humidity level is reached.



To see all dehumidification options, press **MENU > INSTALLER OPTIONS > VIEW/EDIT CURRENT SETUP > DEHUMIDIFICATION.**

## Dehumidification - Commercial

---

The thermostat reads the indoor humidity level and allows the user to set a dehumidification setting.

Dehumidification using the cooling system has the following methods of dehumidification control (ISU 9080):

**Basic:** This option uses the cooling system to reach the desired humidity level. Minimum On Time and High Humidity Comfort Reset are not used with this method. This option should only be used if the equipment can lower the fan speed in a call for dehumidification.

**Minimum on Time (ISU 9090):** This option ensures that the compressor runs long enough to effectively reduce humidity when the cooling equipment is cycled on. The compressor will run for the minimum "on time" you set until the desired humidity level is reached.

**High Humidity Comfort Reset (ISU 9100):** This option uses the cooling system to lower the temperature up to 5 F below the current cool setpoint until the desired humidity is reached. The high humidity comfort range is from 1 to 5 F.

**High Humidity Comfort Reset with Minimum On Time (ISU 9090 and ISU 9100):** This method uses both options above to reduce humidity while maintaining a comfortable temperature.



To see all dehumidification options, press **MENU > INSTALLER OPTIONS > VIEW/EDIT CURRENT SETUP > DEHUMIDIFICATION.**

## Dehumidification Away Mode

Dehumidification Away Mode protects the home when unoccupied for long periods of time during hot and humid weather by maintaining the desired humidity and temperature settings.

To start Dehumidification Away Mode, press Menu, then press Dehumidification Away Mode. The thermostat automatically follows settings that are set by the dealer during installer setup.

Press Cancel to end Dehumidification Away Mode.

### Southern Dehumidification Away Mode Options: (ISU 9180 to 9200)

- Fan: Auto, On or Circulate
- Low Limit Temperature Setting: The thermostat allows the cooling system to lower the indoor air to the Low Limit Temperature Setting to control humidity.
- Temperature Setting: The temperature maintained while Dehumidification Away Mode is active and the desired humidity level is satisfied.
- Dehumidification Setting: The desired humidity level while Dehumidification Away Mode is active.

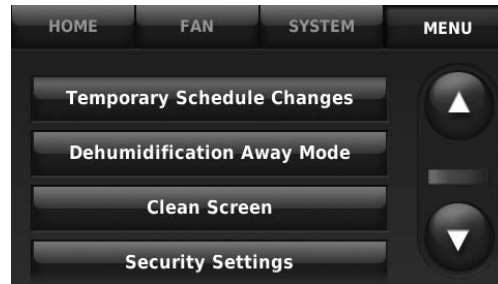

## Ventilation

### Ventilation Control Method (ISU 10050)

The thermostat can control the fan to meet either ASHRAE or Percent On Time settings. If the required ventilation has not been achieved for ASHRAE or Percent On Time during calls for heat and cool, the thermostat will force the fan on.

- **ASHRAE:** The thermostat operates the fan to meet the ASHRAE 62.2 ventilation standard based on CFM, number of bedrooms, and square footage of the house. ASHRAE 62.2 can only be met if the fan is running. If the fan is off for any reason (set up to turn Off during Sleep period, turned off by user etc.), ASHRAE 62.2 is not met during those times.
- **Percent On Time:** The thermostat operates the fan based on a percentage entered in the installer setup (ISU 10120). For example, if Percent On Time is set to 50%, the fan will run at random times during a 1 hour period until it reaches a 50% run time (approximately 30 minutes). Options 10% to 100%.



To see all ventilation options, press **MENU > INSTALLER OPTIONS > VIEW/EDIT CURRENT SETUP > VENTILATION.**

## Indoor sensor operation

---

5040: Which Sensors will be used for TEMPERATURE Control? (Multiple Sensors are Averaged)

THERMOSTAT (Internal)

MAIN LEVEL (Remote)

CRAWL SPACE (Remote)

Back Help Done Next

### Temperature control

The thermostat can be set to respond to its internal temperature sensor, or to an optional remote indoor sensor. If multiple sensors are used, the thermostat will respond to an average of temperatures detected at each sensor.

8010: Which Sensor will be used for Humidification Control?

THERMOSTAT (Internal)

MAIN LEVEL (Remote)

CRAWL SPACE (Remote)

Back Help Done Next

### Humidification control

If optional remote indoor sensors are installed, you can choose which sensor you want to use for humidification control. You can use a different sensor for dehumidification.

9010: Which Sensor will be used for Dehumidification Control?

THERMOSTAT (Internal)

MAIN LEVEL (Remote)

CRAWL SPACE (Remote)

Back Help Done Next

### Dehumidification control

If optional remote indoor sensors are installed, you can choose which sensor you want to use for dehumidification control. For example, you can use one sensor for humidification control, and another for dehumidification.

## Alerts Log

### MENU > INSTALLER OPTIONS > DATA LOGS > ALERTS LOG

The thermostat saves the most recent 25 alerts. It records the date, time, alert status (snoozed, dismissed, recovered), and diagnostic information to help you identify and correct problems.

## User Interactions Log

### MENU > INSTALLER OPTIONS > DATA LOGS > USER INTERACTIONS LOG

Check this log to find out if a problem was caused by an accidental user error. The log shows most changes made to thermostat settings, by time and date, and describes what change was made.

The thermostat records the most recent 250 changes. You can quickly search them by date and time, or by function. This feature can be turned off if necessary, so that no user interactions are recorded.

Examples:

- \* [date, time] Heat temperature set to 80° F
- \* [date, time] System mode set to Off
- \* [date, time] Installer setup changed — heating equipment type

## Replacing system components

---

Follow steps below to disconnect the thermostat and RedLINK accessories.

### To replace a thermostat

At the Portable Comfort Control

- 1 Press and hold the blank space (or arrow if present) in the lower right hand corner of the screen until the display changes.
- 2 Press **REMOVE**, then **YES** to disconnect from the old thermostat.

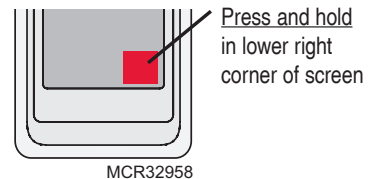

At the Indoor Sensor, Entry/Exit Remote, Vent Boost Remote, RedLINK Internet Gateway or TrueSTEAM Wireless Adapter

- 1 Press and hold the **CONNECT** button on the RedLINK accessory until the status light glows amber (hold for about 10 seconds). This will disconnect the device from the old thermostat.

Re-connect RedLINK accessories

- 1 Follow the steps in “Link optional accessories to wireless network” on page 9.

## Replacing system components

---

### To remove accessories from a thermostat

At the thermostat

- 1 Press **MENU** and scroll down to press **INSTALLER OPTIONS**. Enter the date code (password) when prompted. The date code is printed on the back of the thermostat; or press **MENU > EQUIPMENT STATUS** to find the date code.
- 2 After you enter the password, scroll down to select **WIRELESS DEVICE MANAGER**.
- 3 Press **REMOVE DEVICE**, then select the device you want to remove.

## Specifications & replacement parts

---

### Operating Ambient Temperature

- Thermostat:** 32 to 120° F (0 to 48.9° C)
- Portable Comfort Control:** 32 to 120° F (0 to 48.9° C)
- Wireless Outdoor Sensor:** -40 to 140° F (-40 to 60° C)
- Wireless Indoor Sensor:** 0 to 120° F (-17.8 to 48.9° C)
  - For Optimal Battery Life: 35 to 114° F (1.7 to 45.6° C)
- RedLINK Internet Gateway:** 32 to 120° F (0 to 48.9° C)

### Operating Relative Humidity

- Thermostat:** 5% to 90% (non-condensing)
- Portable Comfort Control:** 5% to 90% (non-condensing)
- Wireless Outdoor Sensor:** 0% to 100% (condensing)
- Wireless Indoor Sensor:** 5% to 90% (non-condensing)
- RedLINK Internet Gateway:** 5% to 95% (non-condensing)

### Physical Dimensions (height, width, depth)

- Thermostat:** 3-7/8 x 6-13/16 x 1-7/16 inches (99 x 173 mm x 36 mm)
- Wireless Outdoor Sensor:** 5 x 3-1/2 x 1-11/16 inches (127 x 89 x 43 mm)
- Wireless Indoor Sensor:** 2-7/8 x 1-7/8 x 15/16 inches (74 x 48 x 24 mm)
- Portable Comfort Control:** 6-1/4 x 3-1/8 x 1-5/8 inches (158 x 80 x 38 mm)
- RedLINK Internet Gateway:** 6 x 4-7/8 x 2-1/2 inches (152 x 124 x 64 mm)

### Electrical Ratings

18 to 30 VAC

### Accessories & Replacement Parts

Item	Honeywell Part Number
RedLINK Internet Gateway	THM6000R1002
Entry/Exit Remote	REM1000R1003
Vent Boost Remote	HVC20A1000
Portable Comfort Control	REM5000R1001
Wireless Outdoor Sensor	C7089R1013
Wireless Indoor Sensor	C7189R1004
Cover Plate (covers marks left by old thermostats)	50028399-001
Battery Pack (For demo use only)	THP1000A1007

## Regulatory information

---

### FCC Compliance Statement (Part 15.19) (USA only)

This device complies with Part 15 of the FCC Rules. Operation is subject to the following two conditions:

- 1 This device may not cause harmful interference, and
- 2 This device must accept any interference received, including interference that may cause undesired operation.

### FCC Warning (Part 15.21) (USA only)

Changes or modifications not expressly approved by the party responsible for compliance could void the user's authority to operate the equipment.

### FCC Interference Statement (Part 15.105 (b)) (USA only)

This equipment has been tested and found to comply with the limits for a Class B digital device, pursuant to Part 15 of the FCC Rules. These limits are designed to provide reasonable protection against harmful interference in a residential installation. This equipment generates uses and can radiate radio frequency energy and, if not installed and used in accordance with the instructions, may cause harmful interference to radio communications. However, there is no guarantee that interference will not occur in a particular installation. If this equipment does cause harmful interference to radio or television reception, which can be determined by turning the equipment off and on, the user is encouraged to try to correct the interference by one of the following measures:

- Reorient or relocate the receiving antenna.
- Increase the separation between the equipment and receiver.
- Connect the equipment into an outlet on a circuit different from that to which the receiver is connected.
- Consult the dealer or an experienced radio/TV technician for help.

### Thermostats and outdoor sensor

To comply with FCC and Industry Canada RF exposure limits for general population/ uncontrolled exposure, the antenna(s) used for these transmitters must be installed to provide a separation distance of at least 20 cm from all persons and must not be co-located or operating in conjunction with any other antenna or transmitter.

### Portable Comfort Control

This portable transmitter with its antenna complies with FCC and Industry Canada RF exposure limits for general population/ uncontrolled exposure. This device must not be co-located or operating in conjunction with any other antenna or transmitter.

### Section 7.1.2 of RSS-GEN

Under Industry Canada regulations, this radio transmitter may only operate using an antenna of type and maximum (or lesser) gain approved for the transmitter by Industry Canada. To reduce potential radio interference to other users, the antenna type and its gain should be so chosen that the equivalent isotropically radiated power (e.i.r.p.) is not more than that necessary for successful communication.

### Section 7.1.3 of RSS-GEN

Operation is subject to the following two conditions:

- 1 this device may not cause interference, and
- 2 this device must accept any interference, including interference that may cause undesired operation of the device.

### Need Help?

For assistance please visit [www.ComfortNet1.com](http://www.ComfortNet1.com), or call toll-free: (888) 593-9988

Honeywell International Inc.  
1985 Douglas Drive North  
Golden Valley, MN 55422  
<http://customer.honeywell.com>



Goodman Manufacturing Co., LP  
Suite 500  
5151 San Felipe  
Houston, TX 77056

© U.S. Registered Trademark. © 2014 Honeywell International Inc.  
69-2688—07 M.S. Rev. 01-14  
I/O-CHTSTAT03  
Printed in U.S.A.